



TRAXXAS

NITRO
STAMPEDE
OPERATING INSTRUCTIONS

MODEL 41096-3

WARNING!

Carefully read and follow all instructions in this and any accompanying materials to prevent serious damage to your model. Failure to follow these instructions will be considered abuse and/or neglect.

Introduction

Thank you for purchasing the Traxxas Nitro Stampede. This manual contains the instructions you will need to operate and maintain your Nitro Stampede. **Look over the manual and examine the Nitro Stampede carefully before running it.** If for some reason you think the Nitro Stampede is not what you wanted, then do not continue any further. **Your hobby dealer absolutely cannot accept a Nitro Stampede for return or exchange after it has been run.**

Please read **ALL** of the operating instructions and precautions before attempting to drive the Nitro Stampede. Even if you are an experienced R/C enthusiast, continue reading to learn about Nitro Stampede's unique features. Pay special attention to the mechanical and safety precautions outlined in the manual.

If you have any questions about your model, or its operation, call the Traxxas Technical Support Line toll-free at 1-888-TRAXXAS (1-888-872-9927); outside the U.S., call +1-972-549-3000. Technical support is available Monday through Friday, from 8:30am to 9:00pm Central Standard Time. Technical assistance is also available through our website at Traxxas.com (e-mail us at support@Traxxas.com). We hope that you will enjoy many hours of fun with your new Nitro Stampede.

Fuel

It's imperative that you use the correct fuel in your Pro.15 engine for maximum performance and engine life. Traxxas Top Fuel® Power Plus™ should be used to ensure correct engine lubrication, performance, and ease of tuning.

- Top Fuel is the only fuel that is 100% certified for use in Traxxas engines.
- Traxxas Top Fuel is made with just the right balance of natural and synthetic lubricants to allow excellent throttle response and the best top-end performance, without sacrificing long-term durability.



You may use 10% or 20% nitro-content fuel. Try to use the same percentage all the time. Avoid switching back and forth between fuels. We recommend that if you break in your engine on 20% fuel that you stick with that percentage. If you do move to a higher or lower percentage, make sure you readjust your fuel mixture to compensate.

Can other brands of fuel be used besides Top Fuel? There are other fuels that can provide satisfactory performance; however, there could be long-term costs in the form of decreased engine performance, loss of tuning ease, and shorter engine life. Only use fuels that contain both castor and synthetic oil.

Everyone has an opinion or a claim to make about fuel. The engineering team at Traxxas has spent years developing Traxxas engines. No one knows more about the specific fuel requirements of Traxxas engines than Traxxas engineers. We strongly urge you not to take chances with your engine investment and use the Traxxas fuel made for Traxxas engines.

PERSONAL SAFETY PRECAUTIONS

Every precaution outlined in this manual needs to be followed to help ensure safe operation. Operate your model sensibly and with care and it will be exciting, safe, and fun for you and your spectators. Failure to operate your model in a safe and responsible manner could result in property damage and serious injury. You alone must see to it that the instructions are followed and the precautions are adhered to.

The Nitro Stampede is not intended for use by children without the supervision of a responsible adult. Traxxas shall not be liable for any loss or damages, whether direct, indirect, special, incidental, or consequential, arising from the use, misuse, or abuse of this product and any chemical or accessory required to operate this product.

Important Points to Remember

- Nitro Stampede is very fast! Children under 16 years of age and inexperienced drivers should not operate the Nitro Stampede without the supervision of a responsible and knowledgeable (experienced) adult.
- **Model engine fuel is dangerous and highly poisonous.** Always follow all directions and precautions printed on the fuel container. Model engine fuel is poisonous to humans and animals. Drinking the fuel can cause blindness and death. Handle with care and respect.
- Model engine fuel, especially when in a fuel dispensing bottle, may look like a cool drink to a child. **Keep all fuel out of the reach of children at all times. Do not place fuel containers on the ground where children can reach them while you are driving.**
- Model engine fuel is flammable. Never allow smoking, sparks, heat, or flame in the presence of fuel or fuel vapors.
- The engine, brakes, and exhaust system may become extremely hot during use. Be careful not to touch these parts, especially when refueling or stopping the engine.
- Prolonged exposure to the engine exhaust can be harmful. Avoid breathing the engine exhaust. Always run your Nitro Stampede outdoors, in a well-ventilated area. Never run the engine indoors.
- Do not operate your Nitro Stampede at night or anytime your line of sight to the model may be obstructed or impaired in any way.
- Never operate your Nitro Stampede in crowds of people or busy pedestrian areas. Nitro Stampede is very fast and could cause injury to those unaware of its presence. Keep small children at a safe distance away from the operating area.
- Because Nitro Stampede is controlled by radio, it is subject to radio interference from many sources beyond your control. Since radio interference can cause momentary loss of control, always allow a safety margin in all directions around your model to prevent collisions.
- The engine can be loud. If the noise makes you uncomfortable, wear ear protection. Be considerate of your neighbors by not running your model early in the morning or late in the evening.
- Do not kink the antenna wire. Kinks in the antenna wire will reduce range.
- Do not cut the antenna "stinger" or any other part of the antenna wire. Cutting the antenna will reduce range.
- You must extend the antenna wire in the model as far as possible for maximum range. In doing so, the antenna wire will be extended outside of the vehicle body. Do not wrap or coil the antenna wire to keep it from extending out of the body.

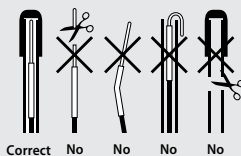

- Do not allow the antenna wire to extend outside the body without the protection of an antenna tube, or the antenna wire may incur crash damage that could reduce range.
- **Most importantly, use good common sense at all times.**

Batteries and Battery Charging

Your model uses rechargeable batteries that must be handled with care for safety and long battery life. Make sure to read and follow all instructions and precautions that were provided with the battery packs and your charger. It is your responsibility to charge and care for the battery packs properly. In addition to your battery and charger instructions, here are some more tips to keep in mind.

- Use the supplied charger to charge the included battery. See "Charging the EZ-Start® Battery" on page 6.
- Do not charge batteries inside of an automobile. Do not charge batteries while driving in an automobile. The charger is equipped with a long cord intended to allow the battery to be charged outside of an automobile when using the automobile's auxiliary power socket. If the cord will not reach outside of the automobile, find another power source.
- Never leave batteries to charge unattended.
- Allow the battery pack to cool off before charging.
- Do not use battery packs that have been damaged in any way. Do not use battery packs that have damaged wiring, exposed wiring, or a damaged connector as this may create the risk of fire.
- Children should have responsible adult supervision when charging and handling batteries.
- Never charge batteries on wood, cloth, carpet or on any other flammable material.
- Do not operate the charger in a cluttered space, or place objects on top of the charger or battery.
- If a battery gets hot to the touch during the charging process (temperature greater than 140°F / 60°C), disconnect the battery from the charger and discontinue charging immediately.
- Always store battery packs safely out of the reach of children and pets.
- Do not expose the charger to water or moisture.
- Do not disassemble the charger.
- Only use approved chargers for Nickel Metal Hydride (NiMH) battery packs. Do not exceed the maximum charge rate of 2 amps.
- Do not short-circuit the battery pack. This may cause burns and severe damage to the battery pack.
- Do not burn or puncture the batteries. Toxic materials could be released. If eye or skin contact occurs, flush with water.
- Store the battery pack in a dry location, away from heat sources and direct sunlight.
- NiMH batteries must be recycled or disposed of properly.

Recycling Your Traxxas Power Cell NiMH Battery

Traxxas strongly encourages you to recycle your Power Cell NiMH battery when it has reached the end of its useful life. **Do not throw your battery in the trash.** All Power Cell NiMH battery packs display the RBRC (Rechargeable Battery Recycling Corporation) icon, indicating they are recyclable. To find a recycling center near you, ask your local hobby dealer or visit www.call2recycle.org.

Fuel Bottle

Fuel is usually purchased by the gallon or quart, so a smaller bottle with a dispensing tube is required to fill the fuel tank. The fuel tank in the Nitro Stampede has a capacity of 75cc. The fuel bottle should always be capped to prevent the fuel from evaporating and becoming contaminated with debris or moisture. The alcohol and nitro contents of the fuel will evaporate, thus upsetting the fuel balance and spoiling the fuel. Do not use old or dirty fuel!



Included Fuel Dispensing Bottle (part #5001)

Other Required Equipment

To operate the Nitro Stampede, you will need these additional items. All of these items should be available from your hobby shop.

1. 8 AA batteries (4 for the transmitter and 4 for the receiver)
2. Small Phillips-head and flat-head screwdrivers (for adjustments)
3. After-run oil (to protect the engine from corrosion)

Traxxas TQi Radio System

Your model includes the latest Traxxas TQi 2.4GHz transmitter with Traxxas Link™ Model Memory. The transmitter's easy-to-use design provides instant driving fun for new R/C enthusiasts, and also offers a full complement of pro-level tuning features for advanced users – or anyone interested in experimenting with the performance of their model. The steering and throttle channels feature adjustable Exponential, End Points, and Sub-Trims. Steering and braking Dual Rate are also available. Many of the next-level features are controlled by the Multi-Function knob, which can be programmed to control a variety of functions. The detailed instructions (page 12) and Menu Tree (page 14) included in this manual will help you understand and operate the advanced functions of the new TQi radio system. For additional information and how-to videos, visit Traxxas.com.

2.4GHz Spread Spectrum – This model is equipped with the latest R/C technology. Unlike AM and FM systems that require frequency crystals and are prone to frequency conflicts, the TQi system automatically selects and locks onto an open frequency, and offers superior resistance to interference and “glitching.”

Current – Current is a measure of power flow through the electronics, usually measured in amps. If you think of a wire as a garden hose, current is a measure of how much water is flowing through the hose.

Frequency band – The radio frequency used by the transmitter to send signals to your model. This model operates on the 2.4GHz direct-sequence spread spectrum.

mAh – Abbreviation for milliamp hour, a measure of the capacity of the battery pack. The higher the number, the longer the battery will last between recharges.

Neutral position – The standing position that the servos seek when the transmitter controls are at the neutral setting.

NiCad – Abbreviation for nickel-cadmium. The original rechargeable hobby pack, NiCad batteries have very high current handling, high capacity, and can last up to 1000 charging cycles. Good charging procedures are required to reduce the possibility of developing a “memory” effect and shortened run times.

NiMH – Abbreviation for nickel-metal hydride. Rechargeable NiMH batteries offer high-current handling and much greater resistance to the “memory” effect. NiMH batteries generally allow higher capacity than NiCad batteries. They can last up to 500 charge cycles. A peak charger designed for NiMH batteries is required for optimal performance.

Receiver – The radio unit inside your model that receives signals from the transmitter and relays them to the servos.

Servo – Small motor units in your model that operate the steering and throttle mechanisms.

Transmitter – The hand-held radio unit that sends throttle and steering instructions to your model.

Trim – The fine-tuning adjustment of the neutral position of the servos, made by adjusting the throttle and steering trim knobs on the face of the transmitter. **Note:** The Multi Function knob must be programmed to serve as a throttle trim adjustment.

2-channel radio system – The TQi radio system, consisting of the receiver, the transmitter, and the servos. The system uses two channels: one to operate the throttle and one to operate the steering.

Transmitter and Receiver



Nitro Stampede Wiring Diagram

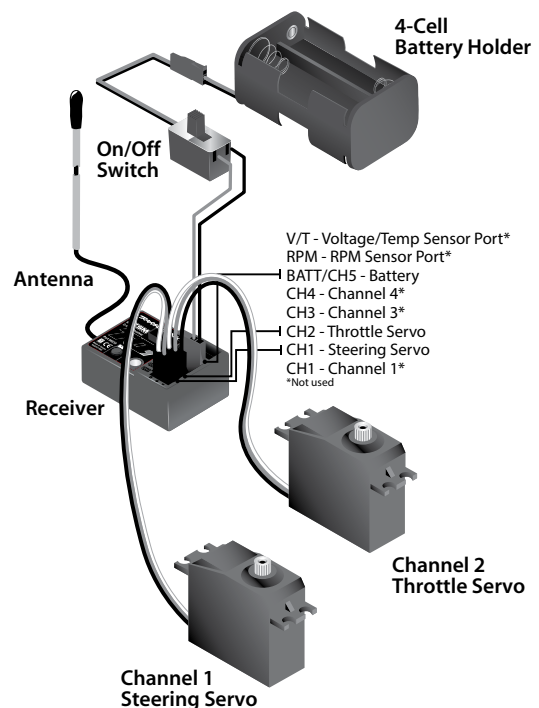

Installing Transmitter Batteries

Your TQi transmitter uses 4 AA batteries. The battery compartment is located in the base of the transmitter.

1. Remove the battery compartment door by pressing the tab and lifting the door up.
2. Install the batteries in the correct orientation as indicated in the battery compartment.
3. Reinstall the battery compartment door and snap it closed.
4. Turn on the transmitter and check the status LED for a solid green light.

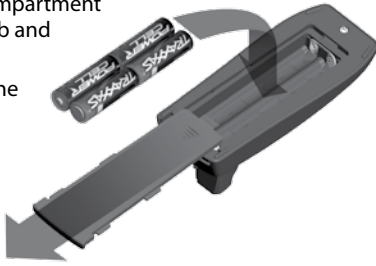

If the status LED flashes red, the transmitter batteries may be weak, discharged, or possibly installed incorrectly. Replace with new or freshly charged batteries. The power indicator light does not indicate the charge level of the battery pack installed in the model. Refer to the LED Codes section on page 5 for more information on the transmitter's status LED codes.

Installing Receiver Batteries

The receiver battery holder is located underneath the battery cover. Remove the battery cover by removing the two body clips from the posts on both sides of the battery holder. Install 4 AA alkaline batteries into the battery holder. Place the battery holder into the battery cover with the cushioning foam. Secure the battery cover to the chassis using the two body clips as shown.

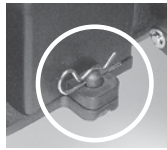

Antenna Setup

The receiver antenna and antenna tube must be properly installed before operating your model. The antenna tube has been precisely cut to match the length of the antenna wire. Follow these steps to install the antenna and antenna tube:

1. Locate the plastic antenna tube supplied with the model. Slide the antenna wire into the antenna tube to its full extent. (When fully inserted, the wire should reach to approximately 1/2 inch below the tube cap. Do not leave any slack in the antenna wire.)
2. Insert the antenna tube into the antenna mount, taking care not to crimp the antenna wire. **To prevent loss of radio range, do not kink or cut the black wire, do not bend or cut the metal tip, and do not bend or cut the white wire at the end of the metal tip. Do not shorten the antenna tube.**

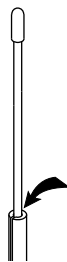

Radio System Rules

- Always turn your TQi transmitter on first and off last. This procedure will help to prevent your model from receiving stray signals from another transmitter, or other source, and running out of control. Your model has electronic fail-safes to prevent this type of malfunction, but the first, best defense against a runaway model is to always turn the transmitter on first and off last.
- In order for the transmitter and receiver to bind to one another, the receiver in the model must be turned on within 20 seconds of turning on the transmitter. The transmitter LED will flash fast red, indicating a failure to link. If you miss it, simply turn off the transmitter and start over.

- Always have the transmitter and receiver turned on before you start the engine. Never turn the radio system off while the engine is running. The on/off switch in the model only turns the receiver on and off. It does not turn off the engine.
- Always use new or freshly charged batteries for the radio system. Weak batteries will limit the radio signal between the receiver and the transmitter. Loss of the radio signal can cause you to lose control of your model.

Radio System Controls

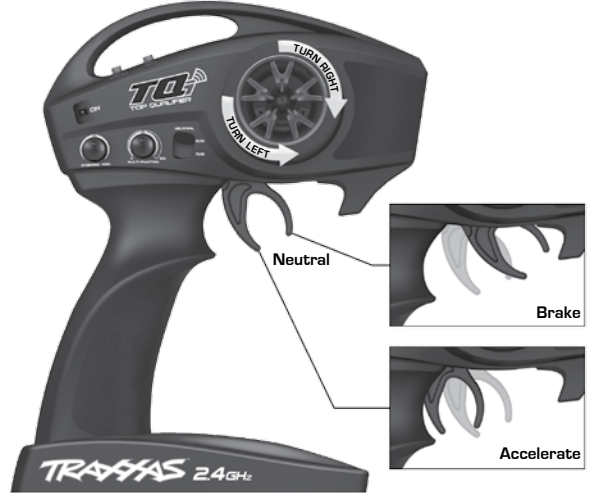

Radio Basic Adjustments

Throttle Neutral Adjustment

The throttle neutral adjustment is located on the transmitter face and controls the forward/reverse travel of the throttle trigger. Change the adjustment by pressing the button and sliding it to the desired position. There are two settings available:

- 50/50: Allows equal travel for both acceleration and reverse.
- 70/30: Allows more throttle travel (70%) and less reverse travel (30%).

50/50 is the required setting for the Nitro Stampedede.

Steering Trim

The electronic steering trim located on the face of the transmitter adjusts the neutral (center) point of the steering channel. **Note:** Traxxas Stability Management (TSM) must be completely turned off while adjusting steering trim. See page 5 for TSM adjustments.



Multi-Function Knob

The Multi-Function knob can be programmed to control a variety of functions. From the factory, the Multi-Function knob controls Traxxas Stability Management (TSM). For more detail on TSM, refer to page 5.



Using the Radio System

The TQi radio system has been pre-adjusted at the factory for correct operation with your model. The adjustment should be checked before running the model, in case of movement during shipping. Here's how:

1. Turn the transmitter switch on. The status LED on the transmitter should be solid green (not flashing).
2. Turn on the receiver switch in the model. The switch is located on the chassis.
3. Position the model so that its front wheels are off the ground. Make sure your hands are clear of the moving parts of the model.

4. Turn the steering wheel on the transmitter back and forth and check for rapid operation of the steering servo. Also, check that the steering mechanism is not loose or binding. If the steering operates slowly, check for weak receiver batteries.
5. When looking down at the model, the front wheels should be pointing straight ahead. If the wheels are turned slightly to the left or right, turn off TSM and slowly adjust the steering trim control on the transmitter until they are pointing straight ahead; then, return the multi-function knob to the desired TSM setting.
6. Operate the throttle trigger on the transmitter and check for rapid operation of the throttle servo. When the throttle trigger is pulled back, the carburetor should open. When the throttle trigger is pushed all the way forward, the brake should lock.
7. Once adjustments are made, turn off the receiver on your model, followed by the hand-held transmitter.

Range-Testing the Radio System

Before each running session with your model, you should range-test your radio system to ensure that it operates properly.

1. Turn on the radio system and check its operation as described in the previous section.
2. Have a friend hold the model with the engine off.
3. Walk away from the model with the transmitter until you reach the farthest distance you plan to operate the model.
4. Operate the controls on the transmitter once again to be sure that the model responds correctly.
5. Do not attempt to operate the model if there is any problem with the radio system or any external interference with your radio signal at your location.

Higher Speeds Require Greater Distance

The faster you drive your model, the more quickly it will near the limit of radio range. At top speeds, models can cover anywhere between 50 to 100 feet every second! It's a thrill, but use caution to keep your model in range. If you want to see your model achieve its maximum speed, it is best to position yourself in the middle of the truck's running area, not the far end, so you drive the truck towards and past your position. In addition to maximizing the radio's range, this technique will keep your model closer to you, making it easier to see and control.

No matter how fast or far you drive your model, always leave adequate space between you, the model, and others. Never drive directly toward yourself or others.

TQi Binding Instructions

For proper operation, the transmitter and receiver must be electronically 'bound.' **This has been done for you at the factory.**

Should you ever need to re-bind the system or bind to an additional transmitter or receiver, follow these instructions.

Note: The receiver must be connected to a 4.8-6.0V (nominal) power source for binding, and the transmitter and receiver must be within 5 feet of each other.

1. Press and hold the transmitter's SET button as you switch the transmitter on. The transmitter's LED will flash red slowly. Release the SET button.
2. Press and hold the receiver's LINK button as you switch on the model. Release the LINK button.
3. When the transmitter and receiver's LEDs turn solid green, the system is bound and ready for use. Confirm that the steering and throttle operate properly before driving your model.

Traxxas Stability Management



Traxxas Stability Management or TSM allows you to experience all the speed and acceleration that was engineered into your Traxxas model by helping you

to maintain control of the vehicle in low-traction situations. TSM helps provide straight ahead full-throttle acceleration on slippery surfaces, without fishtailing, spinouts, or loss of control. TSM also dramatically improves braking control. High speed cornering and control is also made possible as TSM makes corrections for you, without intruding on your fun, or creating unexpected side effects.

The Multi-Function knob on the TQi transmitter has been programmed to control TSM. The recommended (default) setting for TSM is to rotate the knob to the 12:00 position (the zero mark on the dial).

Turn the knob clockwise to increase assistance; turn the knob counterclockwise to decrease assistance. Turn the knob counterclockwise to its stop to turn TSM completely off.

Note: TSM is deactivated automatically when driving or braking in reverse.

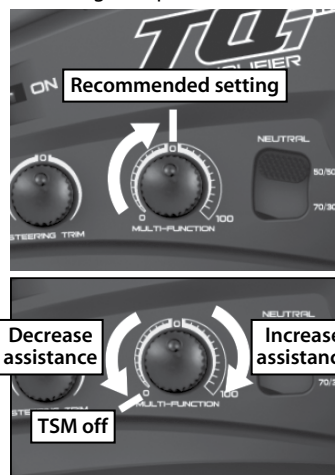

When driving on surfaces with some traction, decrease the TSM setting to allow the vehicle to feel more "loose" for power sliding, drifting, and so on. On surfaces with very little traction (loose dirt, smooth concrete, ice/snow), increase TSM to maximize acceleration and control.

Drive with TSM on and off to test how it is making your control of the vehicle easier and more precise. For more information, visit Traxxas.com/tsm.

Note: TSM must be completely turned off while adjusting steering trim.

Preparing to Run

Charging the EZ-Start® Battery

The included charger can be used to charge the included EZ-Start battery pack. Do not charge batteries inside of an automobile. Read the Safety Precautions section of this guide.

1. Plug the charger into a 12-volt automotive auxiliary power socket.

The charger is compatible with 12-volt automotive auxiliary power sockets only. The LED on the charger will glow red to indicate it is ready to charge a battery.

2. Connect the battery to begin charging. Plug the battery into the charger. The charger's LED will flash green, indicating that charging has begun. The flashing green LED on the charger indicates the charge progress.

CHARGE PROGRESS

1 green flash	0 - 25% charged
2 green flashes	25% - 50% charged
3 green flashes	50% - 75% charged
4 green flashes	75% or more charged
Solid green LED	100% charged

3. Disconnect the battery when charging is complete. When the battery is fully charged, the LED will light solid green. The battery will be warm in your hand. Disconnect the battery.

LED INDICATION	MEANING
Solid Red LED	Ready for Charging
Slowly Flashing Green LED	Charging (see Charge Progress chart)
Solid Green LED	Battery Fully Charged
Flashing Red LED	Charger error

Note: If there is a problem with the battery, such as a short circuit, the charger's LED will flash red. Disconnect the battery and unplug the charger from its power source to clear the error. Determine the cause of the error before continuing.

Installing the EZ-Start battery

1. Press the tab in the end of the battery compartment door to open. (A)
2. Plug a fully charged 7.2-volt battery pack into the connector inside. (B)
3. Twist the battery 2 or 3 times to twirl the battery plug wires. This helps hold the wire and battery in place when the battery is installed in the compartment. (C)
4. Install the battery into the compartment and press the wires securely into place.
5. Snap the battery compartment door back on and lock the end tab. (D)

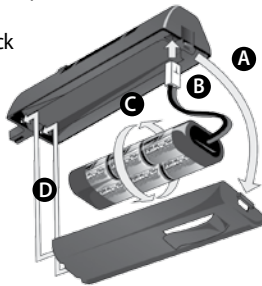

Using the EZ-Start

Your EZ-Start controller plugs into a 4-prong receptacle on the battery cover of your Nitro Stampede. When the red button on the controller is pressed, the EZ-Start motor begins to spin the engine, and power from the control unit heats the glow plug. Assuming all settings and preparations are correct, the engine should start almost immediately.

Each of the two status indicator LEDs on the handheld control unit, the Motor LED and the Glow Plug LED, should light green while starting. If either LED fails to light while starting, there is a fault indicated with that function.

If the Glow Plug LED fails to light, the glow plug may be bad, or the glow plug wire may be damaged or disconnected.

If the Motor LED fails to light and the starter fails to operate, then the EZ-Start is in protection mode.

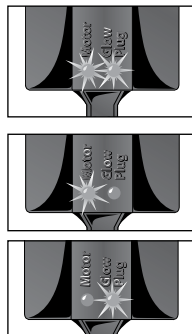

Protection Mode

The EZ-Start uses Smart Start™ technology to monitor the condition of the system and detect failures. The controller

monitors the load being placed on the EZ-Start motor. If the load becomes excessive, the system shuts off power to the motor to prevent costly damage to the motor and the controller. This may occur, for example, if the engine floods with fuel during starting. The starter spins at first, but when excessive fuel in the combustion chamber begins to lock up the engine, the starter motor slows under the heavier load. This causes the protection circuit to shut off the power to the motor. Allow at least three minutes for the starter motor to cool and the circuit to automatically reset before continuing. Use the time to find and eliminate the condition that caused the excessive load on the starter motor.

Use a Strong Starter Battery

A weak starter battery, or one that has not been fully charged, may not deliver enough power to crank the engine over at the appropriate rpm to keep the piston from sticking at top dead center (TDC). A new engine will typically have a tight fit between the piston and the top of the sleeve. This is a tapered fit, and a tight piston sleeve fit on initial start-up is desirable for those who want the best-performing engine. Make sure you are using a good quality battery pack that is fully charged (new batteries usually require several charge cycles to reach peak voltage and full capacity). This is especially important with a new engine that needs to be broken in.

Starting the Engine

Installing the Air Filter

Remove the protective cap from the carburetor air intake. Install the rubber air filter base and pre-lubed foam element onto the carburetor intake. The foam air filter element may be cleaned and reused. **Always be sure the filter element is oiled properly before running the engine.** For the best filtration, use the type of oil made for foam air filters. Traxxas air filter oil is recommended (part #5263). Lightweight motor oil or after-run oil may also be substituted. When the element gets dirty, clean it with dish soap and rinse. Next, saturate it with oil and then squeeze out the excess oil. For extremely dusty conditions, special two or three-stage, pre-lubed filters are available from Traxxas (part #4062 and #4063).



Filling the Fuel Tank

Use a small fuel bottle or bulb, such as the included fuel bottle (part #5001), to put fuel into the tank. Only fill the tank to the bottom of the fill neck. The Nitro Stampede can be carefully refueled while the engine is running.

NOTE:

Your carburetor has been factory preset for break-in. Do not re-adjust your carburetor settings unless you suspect a problem. The following steps are for reference only.

High-Speed Mixture Setting

The high-speed mixture screw controls how much fuel enters the engine during mid- and high-speed operation. Turn the high-speed mixture screw clockwise by hand until it stops (**do not tighten or the needle may be damaged**). Then, turn the mixture screw counterclockwise 2½ turns.

Setting the Idle Speed

The idle speed screw regulates the throttle opening to control the idle speed. The throttle opening at idle should be set as shown in the drawing. The opening should be 1 to 1½ millimeters at the widest point in the opening. The engine may not idle well until it is warmed. Always use the idle speed screw to control engine idle.

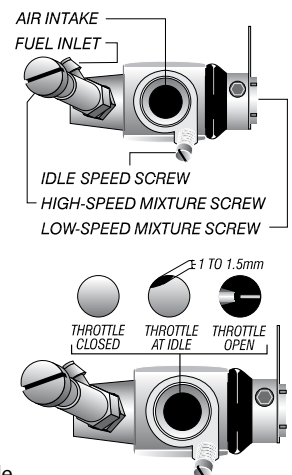

Low-Speed Mixture Setting

This screw meters the fuel at low speeds. The low-speed mixture screw is located in the end of the carburetor, inside the throttle arm. This screw controls how much fuel enters the engine at idle and low throttle. This adjustment will smooth the idle and improve acceleration to mid-speed. Make this adjustment with the throttle closed, after setting the idle. **Gently** turn this screw clockwise until it stops against the needle seat. Be very careful. It's difficult to know when the needle has seated due to the thread-holding material on the needle's thread. **Overtightening of the screw may result in damage to the needle seat.** Now turn the low-speed mixture screw counterclockwise 1¾ turns.

Shutting Off the Engine

Before starting the engine, it is important to know how to shut it off. The correct method is to pinch and hold the carburetor's fuel line at idle speed, until the engine dies.

Starting the Engine

Before you start your engine for the first time, make sure you have read all instructions and precautions in this manual. Pay close attention to the break-in instructions in the next section, and make sure you have read and understood them before you run your engine.

Your engine must be at room temperature (70°F) or above the first time you start it. If it's cooler than room temperature outside, remove all fuel and keep your model indoors until you're ready to start it and then take it outside. We do not recommend running the model in temperatures below 35°F.

1. Turn on the radio system.
2. Make sure the throttle trigger on the transmitter is in the idle (neutral) position.
3. Connect the EZ-Start controller.
4. Press the starter button in short two-second bursts and watch for fuel moving through the fuel line up to the carburetor. Watch closely! The fuel moves very fast. If the fuel doesn't move through the line within 5 seconds, prime the engine by pressing the primer button (built into the fuel tank) several times until the fuel moves through the fuel line towards the carburetor. Watch carefully! If the engine is primed too long, it will flood with fuel and stop turning.
5. Once fuel reaches the carburetor, the engine should quickly start and idle.
6. Disconnect the EZ-Start controller from the model.
7. Proceed with the engine break-in.
8. Do not rev your engine with no load (wheels off the ground).

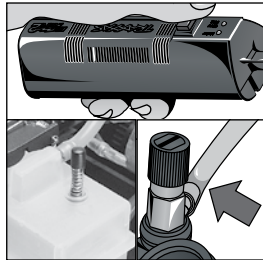

Breaking-in the Engine (Very Important!)

Once your engine is running, it must be broken-in. The key to breaking-in your engine is patience. **The break-in time will take about 1 to 1½ hours.** During the break-in period, your engine may appear to malfunction with symptoms such as stalling, inconsistent performance, and fouled glow plugs. Don't give up on it! These are just "break-in pains" that every new engine has to go through. They will disappear once you get through the break-in period. **Just keep it running, and throttle on and off as smoothly as you can. Sudden bursts or releases of the throttle can stall your engine.** Resist the temptation to tune the engine for performance and/or run for extended times at wide open throttle. Soon, after about the fourth tank of fuel, your patience will pay off with solid, consistent performance.

During Break-in...

- Special break-in fuels are not required.
- Drive the model on a smooth, hard surface.
- If possible, avoid running on very hot, humid days.
- Run with the body off for extra engine cooling.
- Turn the mixture screw (needle) clockwise (in) to lean the mixture and counterclockwise (out) to richen the mixture.
- Do not allow the fuel tank to run completely empty, possibly leading to a burned plug. An extremely low fuel level causes the fuel mixture to be too lean.
- Keep extra glow plugs handy. The break-in process, because of the engine running rich, can cause deposits to form on the glow plug, leading to failure.

The First Tank of Fuel

Drive the Nitro Stampede on a flat, paved surface in an oval configuration. This will cause you to naturally vary your speed over the entire rpm range. During this break-in time, ease in and out on the throttle slowly to avoid stalling the engine. The goal is to simply keep it running. The fuel mixture setting may require slight adjustment to correct for different altitudes and temperature. To tell if the engine is running rich (high volume of fuel flowing through the engine), look for the following conditions:

1. The engine should accelerate sluggishly.
2. There should be a thick trail of blue smoke coming from the exhaust.
3. If you do not observe the conditions above, then turn the high-speed needle out 15° (counterclockwise) and retest.
4. Do not rev the engine with the wheels off the ground. High, no-load rpms can damage the engine, usually resulting in a broken connecting rod. At the end of the first tank of fuel, stop the engine and allow it to cool for 5-10 minutes before proceeding.

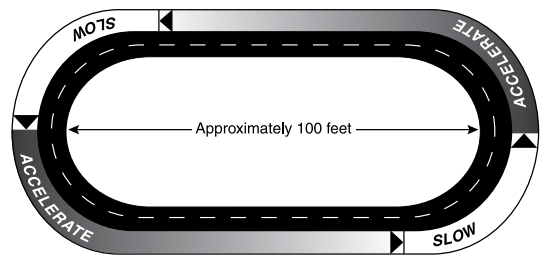

DRIVING PRECAUTIONS

- The radio system is not waterproof. Avoid driving through puddles, wet grass, or mud. Water could damage the electronics.
- Do not continue to operate the Nitro Stampede with low batteries. After the battery power drops below a certain point, the model will continue with the last command it had from the transmitter. Indications of low battery power include slow operation and sluggish servos. On the transmitter, a flashing red light indicates low transmitter batteries.
- Do not drive the Nitro Stampede at night, on public streets, or in large crowds of people.
- If the truck becomes stuck, do not continue to run the engine. Remove the obstruction before continuing to drive.
- Do not attempt to push or tow objects with the Nitro Stampede.
- The model is controlled by radio. It is subject to radio interference from many sources beyond your control. Since radio interference can cause momentary loss of control, allow a safety margin around the truck in order to prevent collisions.
- Use common sense whenever you are driving your model. **Intentionally driving in an abusive and rough manner will only result in poor performance and broken parts.**

Tanks Two Through Four:

Shut off the engine and allow it to cool for 5-10 minutes, then refuel. Turn the high-speed needle in 15° (clockwise). Turn on the radio system and restart the engine. Continue driving on your oval course, varying your throttle, until the second tank of fuel is used up. Repeat this process for tanks 3 and 4. **Important: Do not lean the high-speed mixture less than 2 turns out from closed (see illustration). Also, be sure to allow the engine to cool between each run.**

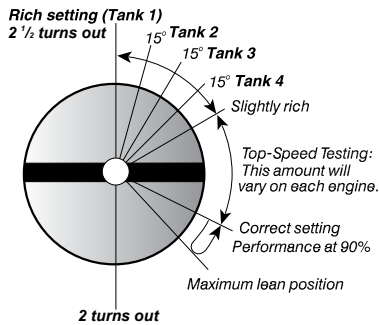

Tuning Your Engine for Best Performance

The engine's performance depends on the fuel mixture. Turn the mixture needles clockwise to lean the fuel mixture and counterclockwise to richen it. Leaning the fuel mixture will increase engine power up to the engine's mechanical limits. **Never run the engine too lean (not enough fuel flow). Leaning the engine beyond the safe allowable limits will result in poor performance and engine damage.** Indications of an overly lean mixture include:

- Cutting out or sudden loss of power during acceleration.
- Overheating (temperature beyond 300°F at the glow plug).
- Little or no blue smoke coming from the exhaust.

If any of these conditions are present, stop immediately and richen the high-speed mixture 1/4 turn. The engine will probably be slightly rich at that setting and you can then re-tune for performance. Always tune for performance by starting rich and moving toward the ideal setting. Never try to tune from the lean side. There should always be a light stream of blue smoke coming from the exhaust.

Before you begin tuning, the engine should be warmed up to its normal operating temperature and running slightly rich. All final tuning adjustments must be made to the engine at its normal operating temperature. You can tell the engine is running rich by noting any of the following:

- Sluggish acceleration with blue smoke coming from the exhaust.
- There is unburned fuel spraying from the exhaust tip.
- Leaning the high-speed fuel mixture increases performance.

High-Speed Fuel Mixture Adjustment

With the engine warm and running at a rich setting, gradually lean the high-speed fuel mixture in 1/16-turn increments. Make several high-speed passes with the Nitro Stampede after each adjustment to clear out the engine and note any change in performance. Continue this procedure until one of the following conditions exists:

1. There is no longer any performance improvement.
2. The engine begins to cut out at high-speed.
3. There is a sudden loss of power during acceleration.
4. The engine begins to overheat. Symptoms of overheating include:
 - Steam or smoke coming from the engine (not exhaust)
 - Hesitation or stalling during acceleration
 - Popping or clattering sound when decelerating (detonation)
 - Fluctuating idle speed
 - Temperature measurement above 300°F at the glow plug

If any one of the above conditions occurs, the fuel mixture is already past the maximum safe lean setting. Richen the fuel mixture to the optimum setting by richening the high-speed needle at least 1/8 turn counterclockwise and retest. This setting will extend engine component life.

Low-Speed Fuel Mixture Adjustment

The low-speed mixture is always set after the high-speed needle is correctly adjusted. The low-speed mixture will be set using the pinch test.

1. Once the engine is warm, do several high-speed runs to confirm that the high-speed needle is set correctly.
2. Bring the vehicle in and pinch closed the fuel line going into the carburetor. The engine should run for 2-3 seconds, speed up, and then die.
3. It is very important to make several high-speed runs with the Nitro Stampede between adjustments to clear out any excess fuel. Perform the pinch test immediately after. If the engine is allowed to idle for a long period of time, it could "load up" with fuel and give you an inaccurate measurement from your pinch test.
4. If the engine runs longer than 3 seconds, then lean the low-speed needle 1/16 turn, make several more high-speed runs, and retest.
5. If the engine dies immediately without speeding up, then richen the low-speed needle 1/8 turn, make several more high-speed runs, and retest.
6. If the engine dies when you try to accelerate abruptly, then the low-speed needle is probably set too lean. Richen the low-speed needle 1/8 turn, make several more high-speed runs, and retest.
7. When the low-speed needle is set correctly, the engine's throttle response should be very quick.

Idle Speed Adjustment

Once the high- and low-speed mixtures have been set, reduce the idle speed to the minimum reliable idle speed. Remember, this adjustment should be made while the engine is running at normal operating temperature. Always use the idle speed screw to control engine idle.

1. When the throttle servo is in its neutral position, the throttle slide should be stopped against the idle speed screw.
2. Turn the screw clockwise to reduce the idle speed or counterclockwise to increase it. The idle speed should be set as low as possible while still maintaining reliable running characteristics.

Fine-Tuning the Carburetor

After fine-tuning your engine at the end of the break-in procedure, no major adjustments to the fuel mixture are usually necessary. Make note of the temperature, humidity, and barometric pressure at the time you finished fine tuning your carburetor. Current weather conditions can be found online from national websites, local TV news websites, and television. This information will be considered your baseline setting. You may need to adjust your carburetor needles to compensate for changes in temperature and barometric pressure (air density) from day to day. Generally, you'll need to richen the fuel mixture when the weather is colder than your baseline temperature and the air density is higher. Lean the fuel mixture when the temperature is warmer than your baseline temperature and the air density is lower. The chart below provides general guidelines on how weather conditions affect air density when they move higher or lower than your baseline setting.

If the...	is..	then the air density is...	the overall mixture should be...
Humidity	Lower	Slightly more dense	Slightly richer
	Higher	Slightly less dense	Slightly leaner
Pressure (barometer)	Lower	Less dense	Leaner
	Higher	More dense	Richer
Temperature	Lower	More dense	Richer
	Higher	Less dense	Leaner
Altitude	Lower	More dense	Richer
	Higher	Less dense	Leaner
Nitro %	Lower	Richer	Richer
	Higher	Leaner	Leaner

Tuning the Engine by Temperature

The following procedures require an optional infrared temperature probe, an on-board temperature gauge, or the Traxxas telemetry temperature sensor (part #6521). The engine can be used as an effective tuning aid when you understand the relationship between engine temperature and ambient temperature.

The engine operating temperature, when tuned for maximum performance, will vary according to atmospheric conditions. The atmospheric condition that has the most influence on engine temperature is air temperature. Expect the engine temperature to vary almost in direct proportion to atmospheric temperature. Assuming you tuned the engine for the same maximum performance each day, the engine will run about twenty degrees hotter when it's ninety degrees outside than it would in seventy-degree weather. For this reason, we cannot give you a definitive temperature range that indicates the best possible engine tuning.

The temperature gauge can aid you in tuning by giving you a relative indication of how your adjustments are affecting the engine and by preventing you from exceeding maximum engine temperature. For example, as you lean the fuel mixture, the engine performance will increase along with the temperature. If you continue to lean the fuel mixture and the temperature increases but the engine performance does not change, then you have exceeded the maximum safe lean setting.

If tuning for maximum performance results in engine temperature exceeding 300°F, try to increase airflow to the engine by cutting out the rear of the body, windshield, and front valance. If the engine temperature still cannot be kept in check, richen the high-speed needle slightly.

Adjustments

Toe-in

Geometry and alignment specifications play an important role in your truck's handling, so take the time to set them correctly. Turn off TSM (see page 5); then, set the steering trim on your transmitter to neutral. Now, adjust your tie rods so that both wheels are pointing straight ahead and are parallel to each other (0° toe-in). This will ensure the same amount of steering in both directions. If you run out of adjustment, then the steering servo will have to be re-centered (see "Centering your Servos" on page 10). **For increased stability, add 1°- 2° of toe-in to each front wheel. Use the turnbuckles to adjust the alignment.**

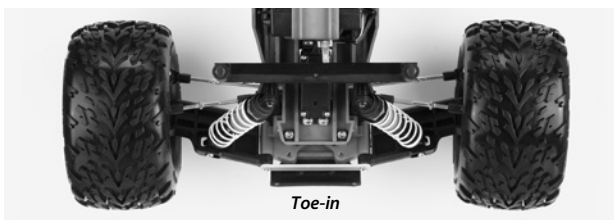

Camber

The camber angle of both the front and rear wheels can be adjusted with the camber rods (upper turnbuckles). Use a square or right-angle triangle to set the camber accurately. Adjust the front wheels to 0° of camber (wheel perpendicular to the ground). In the rear, adjust the wheels to 1° to 2° of negative camber. These adjustments should be set with the truck positioned at its normal ride height.



Positive camber

Negative camber

Shocks

The four shocks on Nitro Stampede have the most influence on its handling. Whenever you rebuild your shocks or make any changes to the pistons, springs, or oil, always do it carefully and in pairs (front or rear).

Piston selection depends on the range of oil viscosities that you have available. For example, using a two-hole piston with a lightweight oil will, at one point, give you the same damping as a three-hole piston with heavier oil. We recommend using the two-hole pistons with a range of oil viscosities from 10W to 50W (available from your hobby shop). The thinner viscosity oils (30W or less) flow more smoothly and are more consistent, while thicker oils provide more damping. **Use only 100% pure silicone shock oil to prolong seal life.**

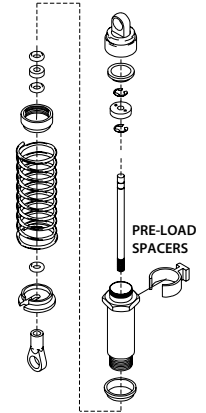

The ride height for Nitro Stampede can be adjusted by adding or removing the clip-on spring pre-load spacers. Instead of adding spacers to increase stiffness, use stiffer springs. Adjust the ride height so that the suspension arms are slightly above being parallel to the ground. Observe how the Nitro Stampede handles in turns. If it is picking up the inside rear wheel in hard turns, then stiffen the *front* suspension. If it is picking up the inside front wheel in hard turns, then stiffen the *rear* suspension. Proper set-up will add stability and help prevent roll-overs.

Gear Ratios

A unique Nitro Stampede feature is the ability to change the gear ratios. The final drive ratio of the gearbox is 2.81 to 1. Use the following formula to calculate the overall ratio:

$$\frac{\text{Number of Spur Gear Teeth}}{\text{Number of Clutch Bell Gear Teeth}} \times 2.81 = \text{Final Drive Ratio}$$

Nitro Stampede comes with a 70-tooth spur gear and a 20-tooth pinion (clutch bell) gear. This combination will provide the best overall acceleration and top speed. If you want more acceleration and less top speed, then use a smaller clutch bell gear (fewer teeth). For more top speed, use a larger clutch bell gear.

Pinion	Spur Gear	Final Drive	
22	66	8.43:1	TOP SPEED ↑ ↓ ACCELERATION
22	70	8.94:1	
22	72	9.19:1	
20	70	9.83:1	
20	72	10.11:1	
18	70	10.92:1	
18	72	11.24:1	
16	70	12.27:1	
16	72	12.64:1	

Adjusting the Slipper Clutch

The Nitro Stampede features an adjustable slipper clutch on the spur gear to protect the drivetrain from sudden shock loads (such as landing off of jumps with the engine at full throttle). Under normal conditions, the slipper clutch should not slip. Before adjusting the slipper clutch, turn the model off. Do not adjust the slipper clutch while the engine is running.

Use the supplied wrench to tighten the slipper nut (clockwise) until it stops, and then back the nut out 1/4 of a turn. If you notice any decrease in performance after making changes to the slipper clutch adjustment, then it may be too loose. The slipper must not be allowed to slip during normal acceleration or the slipper could be damaged.

Changing the Clutch Bell and Spur Gears

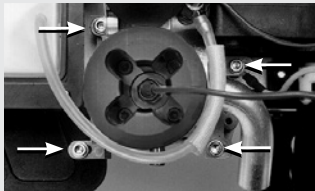

Remove the rubber exhaust pipe and the tuned pipe. Remove the electric starter drive. Loosen the four 3x8mm cap-head screws that hold the slotted adjusting plates to the engine mount.



Remove the 4mm nylon locknut and the spring from the slipper clutch. Try to remove the slipper clutch as one assembly by holding the pressure plates together with your thumb and index finger.

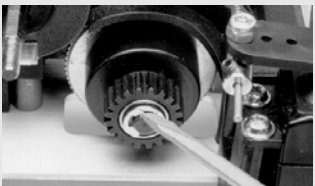

Remove the large E-clip on the clutch shaft and the clutch bell gear. Remove the ball bearings and install them in the new clutch bell gear. Reinstall the clutch bell gear and E-clip.

Note: Smaller clutch bell gears use smaller ball bearings. Refer to your parts list for the correct bearings. Reinstall the spur gear on the top shaft and secure it with the 4mm locknut.



Slide a strip of thin note paper between the spur gear and the clutch bell gear. Push the clutch bell gear against the spur gear and tighten the 3x8mm adjusting plate screws. Remove the paper; the gear mesh should be correctly adjusted.

After-Run Procedure

You must perform after-run maintenance on your engine whenever the model will be stored for longer than a few hours. Taking the time to prepare your engine for storage will reward you with longer engine life, easier starting, and better performance.

When a nitro engine is shut off, some excess unburned fuel remains in the engine. The methanol in model engine fuel is hydroscopic, which means it easily attracts and absorbs moisture. This moisture can cause rust and corrosion on the steel engine parts (crankshaft, bearings, wrist pin, and starter shaft) if the fuel is not removed from the engine. There are after-run oil products available from your hobby dealer or you can use WD-40®, a common household lubricant. To ensure your engine is protected from internal corrosion, use the following procedure:

1. Shut off the engine by pinching the fuel line closed. This allows most of the excess fuel to be consumed by the engine. Be sure the throttle is in the idle position. You may have to pinch the fuel line closed for several seconds before the engine stops.
2. Completely empty the fuel tank. Use your fuel-dispensing bottle to suck out the old fuel. Do not mix the old fuel with your fresh fuel supply. If you leave fuel in the tank, transporting or handling your model may cause fuel to run into the engine.
3. With the fuel tank empty and the throttle at the idle position, try to start the engine. The engine will most likely start and run for a few seconds as it uses up any fuel remaining in the engine and fuel lines.
4. Once the engine stops, clean the outside of the engine with compressed air or spray motor cleaner. Once the engine is clean and dry, remove the glow plug power wire, glow plug, and air filter.
5. Open the throttle fully and spray a one-second burst of WD-40 into the carburetor and into the glow plug hole (Caution! Wear safety glasses to prevent spray from getting into your eyes). If you are using after-run oil, follow the manufacturer's instructions.
6. Place a rag or paper towel over the engine to catch any WD-40 or after-run oil that may come out of the carburetor or glow plug hole.
7. Connect the EZ-Start controller to the model and spin the engine for 10 seconds.
8. Remove the rag or paper towel and repeat steps 5–7 two more times.
9. Clean and re-oil the air filter so it will be ready for use next time.
10. Replace the glow plug, reconnect the glow plug power wire, and reinstall the air filter.

Centering your Servos

Whenever your radio system has been removed for service or cleaning, the servos must be re-centered prior to installing the radio system in the model. If the radio system is installed in the truck, disconnect the servo horns from the servos.

Connect the steering servo to channel 1 on your receiver and the throttle servo to channel 2. The white wire on each servo cable is positioned towards the center. Connect the red and black cable from the battery holder to the "batt" terminal on the receiver. The red wire is positive and the black wire is negative.

Place fresh AA batteries in the transmitter and turn the power switch on. Turn the Steering Trim knob to the center position. Now install fresh AA batteries into the battery holder and turn the power switch to the "on" position. The servos will automatically jump to their center positions. Turn off the battery holder switch followed by the transmitter. The servos are now ready to be installed. Be careful not to move the servo shaft when reinstalling the servo horns.

Maintenance

Nitro Stampede requires timely maintenance in order to stay in top running condition. **Neglecting the maintenance could allow dirt, deposits, and moisture to build up inside the engine, leading to internal engine failure.** The following procedures should be taken very seriously.

After each hour of running:

- Clean and re-oil the air filter. The instructions for this procedure are on page 6. **We cannot stress enough the value of cleaning your air filter at the scheduled intervals.** The cleanliness and condition of your air filter directly influences the running life span of your engine. **Do not skip air filter maintenance!**
- Clean the outside of the engine of accumulated dirt, oil, and grime. Accumulated grime will decrease the engine's ability to cool itself.
- Tighten the wheel nuts (especially on the left side).

After each running session:

- Perform after-run maintenance on the engine. This clears the engine of destructive moisture and other corrosive deposits. **This is extremely important for the life of the engine.**
- Inspect the gears for wear, broken teeth, or debris lodged between the teeth.
- Inspect the vehicle for obvious damage or wear. Look for:
 1. Loose or missing screws
 2. Cracked, bent, or damaged parts
 3. Cut or loose wiring
 4. Cut or kinked fuel lines
 5. Signs of fuel leakage

Other periodic maintenance:

- **Connecting rod:** The connecting rod should be replaced when the piston and sleeve are replaced. Also replace the piston wrist pin and G-clip whenever the connecting rod is replaced. As with other internal engine components, connecting rod life depends on engine usage and the quality and frequency of engine maintenance. Inspect the connecting rod after three gallons of fuel have been used.
- **Slipper clutch pegs** (friction material): The slipper clutch pegs will wear over time and require replacement. The life of the pegs depends on how the slipper clutch was adjusted and how the Nitro Stampede was used. If the slipper will not tighten or you are seeing signs of wear on the face of the gear, then the pegs should be replaced.
- **Piston/sleeve:** The life of the piston and sleeve will vary greatly with how the engine was used and maintained. The piston and sleeve should be replaced when they no longer seal effectively (loss of compression). Symptoms include the engine being difficult to start when warm, stalling when warm, and stalling when throttle is suddenly closed to idle. Replace the wrist pin and G-clip whenever the piston and sleeve are replaced.

Clearing a Flooded Engine

If the engine is primed for too long during startup, then it can become flooded with fuel. When the engine is flooded it will no longer turn due to excess fuel in the combustion chamber preventing upward movement of the piston. Use the following procedure to clear a flooded engine:

1. Remove the blue glow plug wire.
2. Remove the glow plug and gasket with the glow plug wrench supplied with your model. A 5/16 or 8mm nut driver will also work.
3. Turn the model upside down and plug in the EZ-Start controller.
4. Push the EZ-Start button for several seconds to clear the engine of excess fuel. Do not look into the glow plug hole while the engine is spinning or you could spray fuel into your face!
5. Turn the model over and reinstall the glow plug and gasket.
6. Reconnect the blue glow plug wire to the glow plug.
7. Reconnect the EZ-Start controller.
8. Do not prime the engine. Pull the throttle to 1/2 throttle and push the EZ-Start button. The engine should start immediately.

Piston stuck at "top dead center" (TDC)

"Top dead center" is the position where the piston is at the very top of the tapered sleeve. Occasionally an engine can get "stuck" at this position. This is most likely to happen on new engines during break-in, but can also happen at other times. If the engine is stuck at TDC, use the following procedure to release the piston from the sleeve:

1. Remove the glow plug using the included tool or 8mm (5/16") nut driver and verify that the piston is at the top of its stroke.
2. Turn the model over and locate the flywheel through the cutout in the chassis. Insert a flat blade screwdriver as shown between the chassis and flywheel. Using the chassis for leverage, rotate the flywheel counterclockwise by pressing down on the screwdriver. The flywheel will turn, unsticking the piston from the sleeve.
3. Put two or three drops of light machine oil into the glow plug hole to lubricate the piston and sleeve. Do not use too much oil. It will hydro-lock the engine. Verify the starter will spin the engine with the glow plug out.
4. Rotate the flywheel so the piston is at bottom dead center and replace the glow plug and gasket. Reconnect the blue glow plug wire.
5. You should now be able to start the engine with the EZ-Start.

TQi Advanced Tuning Guide

Your Traxxas transmitter has a programmable Multi-Function knob that can be set to control various advanced transmitter functions (set to Traxxas Stability Management (TSM) by default, see page 5). Accessing the programming menu is done by using the menu and set buttons on the transmitter and observing signals from the LED. An explanation of the menu structure follows on page 14. Experiment with the settings and features to see if they can improve your driving experience.

Steering Sensitivity (Exponential)

The Multi-Function knob on the TQi transmitter can be set to control Steering Sensitivity (also known as exponential). The standard setting for Steering Sensitivity is “normal (zero exponential)”, with the dial full left in its range of travel. This setting provides linear servo response: the steering servo’s movement will correspond exactly with the input from the transmitter’s steering wheel. Turning the knob clockwise from the left will result in “negative exponential” and decrease steering sensitivity by making the servo less responsive near neutral, with increasing sensitivity as the servo nears the limits of its travel range. The farther you turn the knob, the more pronounced the change in steering servo movement will be. The term “exponential” comes from this effect; the servo’s travel changes exponentially relative to the input from the steering wheel. The exponential effect is indicated as a percentage—the greater the percentage, the greater the effect. The illustrations below show how this works.

Normal Steering

Sensitivity (0% exponential): In this illustration, the steering servo’s travel (and with it, the steering motion of the model’s front wheels) corresponds precisely with the steering wheel. The ranges are exaggerated for illustrative purposes.

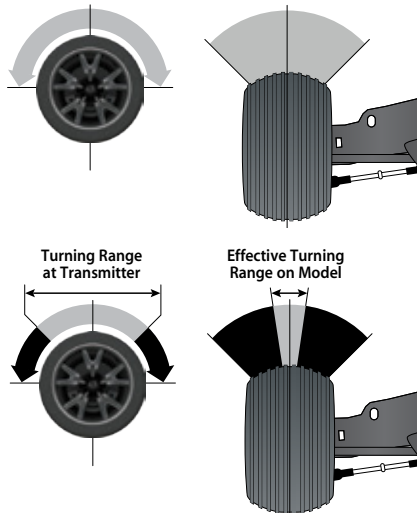

Decreased Steering Sensitivity (Negative Exponential): By turning the Multi-Function knob clockwise, the steering sensitivity of the model will be decreased. Note that a relatively large amount of steering wheel travel results in a smaller amount of servo travel. The farther you turn the knob, the more pronounced the effect becomes. Decreased steering sensitivity may be helpful when driving on low-traction surfaces, when driving at high speed, or on tracks that favor sweeping turns where gentle steering inputs are required. The ranges are exaggerated for illustrative purposes.

Throttle Sensitivity (Throttle Exponential)

The Multi-Function knob can be set to control Throttle Sensitivity. Throttle Sensitivity works the same way as Steering Sensitivity, but applies the effect to the throttle channel. Only forward throttle is affected; brake/reverse travel remains linear regardless of the Throttle Sensitivity setting.

Steering Percentage (Dual-Rate)

The Multi-Function knob can be set to control the amount (percentage) of servo travel applied to steering. Turning the Multi-Function knob fully clockwise will deliver maximum steering throw; turning the knob counterclockwise reduces steering throw (note: turning the dial counterclockwise to its stop will eliminate all servo travel). Be aware that the steering End Point settings define the servo’s maximum steering throw. If you set Steering Percentage to

100% (by turning the Multi-Function knob fully clockwise), the servo will travel all the way to its selected end point, but not past it. Many racers set Dual-Rate so they have only as much steering throw as they need for the track’s tightest turn, thus making the model easier to drive throughout the rest of the course. Reducing steering throw can also be useful in making a model easier to control on high-traction surfaces, and limiting steering output for oval racing where large amounts of steering travel are not required.

Braking Percentage

The Multi-Function knob may also be set to control the amount of brake travel applied by the servo in a nitro-powered model. Electric models do not have a servo-operated brake, but the Braking Percentage function still operates the same way in electric models. Turning the Multi-Function knob full clockwise will deliver maximum brake throw; turning the knob counterclockwise reduces brake throw (**Note:** Turning the dial counterclockwise to its stop will eliminate all brake action).

Throttle Trim

Setting the Multi-Function knob to serve as throttle trim will allow you to adjust the throttle’s neutral position to prevent unwanted brake drag or throttle application when the transmitter trigger is at neutral. **Note:** Your transmitter is equipped with a Throttle Trim Seek mode to prevent accidental runaways. See the sidebar for more information.

Steering and Throttle End Points

The TQi transmitter allows you to choose the limit of the servo’s travel range (or its “end point”) independently for left and right travel (on the steering channel) and throttle/brake travel (on the throttle channel). This allows you to fine-tune the servo settings to prevent binding caused by the servo moving steering or throttle linkages (in the case of a nitro model) farther than their mechanical limits. The end point adjustment settings you select will represent what you wish to be the servo’s maximum travel; the Steering Percentage or Braking Percentage functions will not override the End Point settings.

Steering and Throttle Sub-Trim

The Sub-Trim function is used to precisely set the neutral point of the steering or throttle servo in the event that simply setting the trim knob to “zero” does not completely center the servo. When selected, Sub-Trim allows finer adjustment to the servo output shaft’s position for precise setting of the neutral point. Always set the Steering Trim knob to zero before making final adjustment (if required) using Sub-Trim. If Throttle Trim has been previously adjusted, the Throttle Trim will need to be reprogrammed to “zero” before making final adjustment using Sub-Trim.

Setting Lock

Once you’ve adjusted all of these settings the way you like them, you may want to disable the Multi-Function knob so none of your settings can be changed. This is especially handy if you operate multiple vehicles with a single transmitter via Traxxas Link™ Model Memory.

Multiple Settings and the Multi-Function Knob

It is important to note that settings made with the Multi-Function knob are “overlaid” on top of each other. For example, if you assign the Multi-Function to adjust Steering Percentage and set it for 50%, then reassign the knob to control Steering Sensitivity, the transmitter will “remember” the Steering Percentage setting. Adjustments you make to Steering Sensitivity will be applied to the 50% steering throw setting you selected previously. Likewise, setting the Multi-Function knob to “disabled” will prevent the knob from making further adjustments, but the last setting of the Multi-Function knob will still apply.

Traxxas Link Model Memory

Traxxas Link Model Memory is an exclusive, patent-pending feature of the TQi transmitter. Each time the transmitter is bound to a new receiver, it saves that receiver in its memory, along with all the settings assigned to that receiver. When the transmitter and any bound receiver are switched on, the transmitter automatically recalls the settings for that receiver. There is no need to manually select your vehicle from a list of model memory entries.

Model Lock

The Traxxas Link Model Memory feature can store up to thirty models (receivers) in its memory. If you bind a thirty-first receiver, Traxxas Link Model Memory will delete the "oldest" receiver from its memory (in other words, the model you used the longest time ago will be deleted). Activating Model Lock will lock the receiver in memory so it cannot be deleted.

You may also bind multiple TQi transmitters to the same model, making it possible to pick up any transmitter and any previously bound model in your collection and simply turn them on and drive. With Traxxas Link Model Memory, there is no need to remember which transmitter goes with which model, and there is never a need to have to select any model from a list of model memory entries. The transmitter and receiver do it all for you automatically.

To activate Model Lock:

1. Switch on the transmitter and receiver you wish to lock.
2. Press and hold MENU. Release when the status LED blinks green.
3. Press MENU three times. The status LED will blink green four times repeatedly.
4. Press SET. The status LED will blink green in single-flash intervals.
5. Press SET once. The status LED will blink red once repeatedly.
6. Press MENU once. The status LED will blink red twice repeatedly.
7. Press SET. The LED will blink rapidly green. The memory is now locked. Press and hold MENU to return to driving mode.











Note: To unlock a memory, press SET twice at step 5. The LED will blink rapidly green to indicate the model is unlocked. To unlock all models, press MENU twice at step 6 and then press SET.

To delete a model:



At some point, you may wish to delete a model you no-longer drive from the memory.

1. Switch on the transmitter and receiver you wish to delete.
2. Press and hold MENU. Release when the status LED blinks green.
3. Press MENU three times. The status LED will blink green four times repeatedly.
4. Press SET once. The status LED will blink green once repeatedly.
5. Press MENU once. The status LED will blink green twice repeatedly.
6. Press SET. The memory is now selected to be deleted. Press SET to delete the model. Press and hold MENU to return to driving mode.

Transmitter LED Codes

LED Color / Pattern	Name	Notes	
Ⓢ	Solid green	Normal Driving Mode	See page 4 for information on how to use your transmitter controls.
 Ⓢ	Slow red (0.5 sec on / 0.5 sec off)	Binding	See page 5 for more information on binding.
 	Flashing fast green (0.1 sec on / 0.15 sec off)	Throttle Trim Seek Mode	Turn the Multi Function knob right or left until the LED stops flashing. See above for more information.
	Flashing medium red (0.25 sec on / 0.25 sec off)	Low Battery Alarm	Put new batteries in the transmitter. See page 4 for more information.
 	Flashing fast red (0.125 sec on / 0.125 sec off)	Link Failure / Error	Transmitter and receiver are no longer bound. Turn the system off and then back on to resume normal operation. Find source of the link failure (ie out of range, low batteries, damaged antenna).
Programming Patterns			
 	Counts out number (green or red) then pauses	Current menu position	See Menu Tree for more information.
 x8	Fast green 8 times	Menu setting accepted (on SET)	
 x8	Fast red 8 times	Menu SET invalid	User error such as trying to delete a locked model.

Receiver LED Codes

LED Color / Pattern	Name	Notes	
Ⓢ	Solid green	Normal Driving Mode	See page 4 for information on how to use your transmitter controls.
 Ⓢ	Slow red (0.5 sec on / 0.5 sec off)	Binding	See page 5 for more information on binding.
 	Flashing fast red (0.125 sec on / 0.125 sec off)	Fail-Safe / Low Voltage Detect	Consistent Low Voltage in the receiver triggers Fail-Safe so there is enough power to center the throttle servo before it completely loses power.

FCC Compliance

This device contains a module that complies with the limits for a Class B digital device as described in part 15 of the FCC rules. Operation is subject to the following two conditions: (1) This device may not cause harmful interference, and (2) this device must accept any interference received, including interference that may cause undesired operation.

The limits for a Class B digital device are designed to provide reasonable protection against harmful interference in residential settings. This product generates, uses and can radiate radio frequency energy, and, if not operated in accordance with the instructions, may cause harmful interference to radio communications. The user is cautioned that changes or modifications not expressly approved by the party responsible for compliance could void the user's authority to operate the equipment.

Canada, Industry Canada (IC)

This Class B digital apparatus complies with Canadian ICES-003 and RSS-210. This device complies with Industry Canada license exempt RSS standard(s). Operation is subject to the following two conditions: This device may not cause interference, and This device must accept any interference, including interference that may cause undesired operation of the device.

Radio Frequency (RF) Exposure Statement

This equipment complies with radio frequency exposure limits set forth by FCC and Industry Canada for an uncontrolled environment. This equipment should be installed and operated with a minimum distance of 20 centimeters between the radiator and your body or bystanders and must not be co-located or operated in conjunction with any other antenna or transmitter.

MENU TREE

The Menu Tree below shows how to navigate through the TQi transmitter's various settings and functions. Press and hold MENU to enter the Menu Tree, and use the following commands to navigate through the menu and select options.

MENU: When you enter a menu, you always start at the top. Press MENU to move down the Menu Tree. When you reach the bottom of the tree, pressing MENU again will return you to the top.

SET: Press SET to move across the Menu Tree and select options. When an option is committed to the transmitter's memory, the status LED will rapidly blink green.

BACK: Press both MENU and SET to go back one level in the Menu Tree.

EXIT: Press and hold MENU to exit programming. Your selected options will be saved.

ECHO: Press and hold SET to activate the "echo" function. Echo will "play back" your current position on the Menu Tree should you lose your place. For example: If your current position is Steering Channel End Points, holding SET will cause the LED to blink green twice, green once, and then red three times. Echo will not alter your adjustments or change your position in the programming sequence.

Below is an example of how to access a function in the Menu Tree. In the example, the user is setting the Multi-Function knob to be a Steering % (Dual-Rate) control.

- To set the Multi-Function knob to control STEERING % (DUAL-RATE):**
1. Switch the transmitter on.
 2. Press and hold MENU until the green LED lights. It will blink in single intervals.
 3. Press SET. The red LED will blink in single intervals to indicate Steering Sensitivity (Expo) has been selected.
 4. Press MENU twice. The red LED will blink three times repeatedly to indicate Steering % (Dual-Rate) has been selected.
 5. Press SET to select. The green LED will blink 8 times fast to indicate successful selection.
 6. Press and hold MENU to return to driving mode.

Restoring Factory Defaults:

Transmitter OFF	Hold both MENU and SET	Transmitter ON	Release MENU and SET red LED blinks
-----------------	------------------------	----------------	-------------------------------------

Press SET to clear settings. LED will turn solid green. Transmitter is restored to default

*Torque Control is a feature designed only for use with the power system in the Traxxas Funny Car Race Replica (Model #6907).

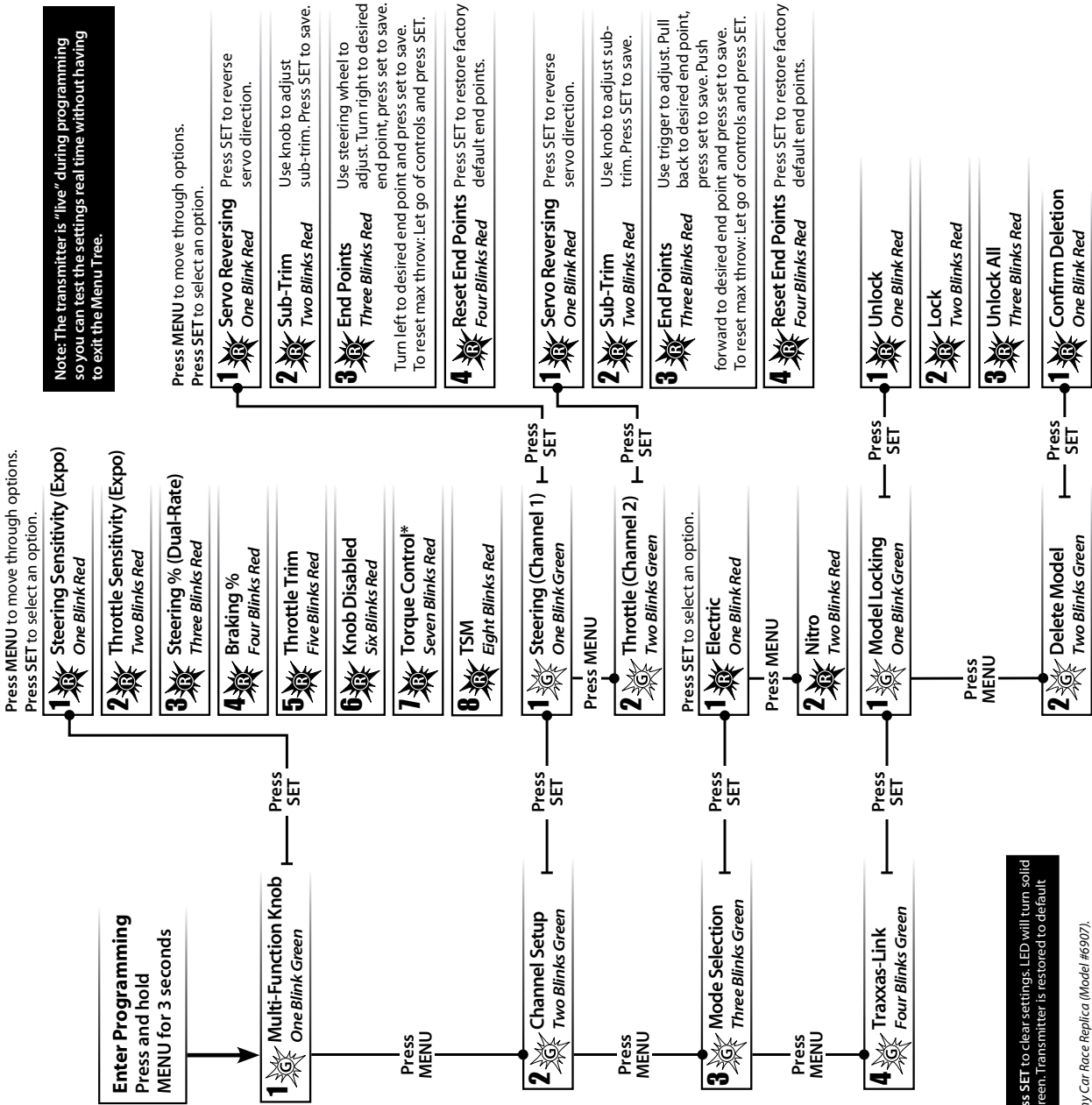

Note: The transmitter is "live" during programming so you can test the settings real time without having to exit the Menu Tree.

MENU TREE FORMULAS

To select functions and make adjustments to the TQi transmitter without referencing the menu tree, turn your transmitter on, find the function in the left column you wish to adjust, and simply follow the corresponding steps.



Set Multi-Function knob for STEERING SENSITIVITY (Expo)		Press SET red LED blinks	x8 Press SET to confirm green LED blinks (x8)	Press/hold MENU green LED blinks	Press/hold MENU returns to driving mode
Set Multi-Function knob for THROTTLE SENSITIVITY (Expo)		Press SET red LED blinks	x2 Press MENU to confirm red LED blinks (x2)	Press/hold MENU green LED blinks	Press/hold MENU returns to driving mode
Set Multi-Function knob for STEERING DUAL RATE (%)		Press SET red LED blinks	x3 Press MENU twice red LED blinks (x3)	Press/hold MENU green LED blinks	Press/hold MENU returns to driving mode
Set Multi-Function knob for BRAKING PERCENTAGE (%)		Press SET red LED blinks	x4 Press MENU 3 times red LED blinks (x4)	Press/hold MENU green LED blinks	Press/hold MENU returns to driving mode
Set Multi-Function knob for THROTTLE TRIM		Press SET red LED blinks	x5 Press MENU 4 times red LED blinks (x5)	Press/hold MENU green LED blinks	Press/hold MENU returns to driving mode
To LOCK the Multi-Function knob		Press SET red LED blinks	x6 Press MENU 5 times red LED blinks (x6)	Press/hold MENU green LED blinks	Press/hold MENU returns to driving mode
To REVERSE the direction of STEERING servo		Press MENU green LED blinks (x2)	x2 Press SET green LED blinks	Press SET to reverse servo direction	Press/hold MENU returns to driving mode
To set the SUB TRIM of the STEERING servo		Press MENU green LED blinks (x2)	x2 Press SET green LED blinks	Press MENU 2 times red LED blinks (x2)	Press SET to save position
To set the END POINTS of the STEERING servo		Press MENU green LED blinks (x2)	x2 Press SET green LED blinks	Press MENU twice red LED blinks (x2)	Press SET to save position
To reset the END POINTS of STEERING servo to defaults		Press MENU green LED blinks (x2)	x2 Press SET green LED blinks	Press MENU 3 times red LED blinks (x4)	Press/hold MENU returns to driving mode
To REVERSE the direction of THROTTLE servo		Press MENU green LED blinks (x2)	x2 Press SET green LED blinks	Press SET reverse servo direction	Press/hold MENU returns to driving mode
To set the SUB TRIM of the THROTTLE servo		Press MENU green LED blinks (x2)	x2 Press SET green LED blinks	Press MENU 2 times red LED blinks (x2)	Press SET to save position
To set the END POINTS of the THROTTLE servo		Press MENU green LED blinks (x2)	x2 Press SET green LED blinks	Press MENU twice red LED blinks (x3)	Press SET to save position
To reset the END POINTS of THROTTLE servo to defaults		Press MENU green LED blinks (x2)	x2 Press SET green LED blinks	Press MENU 3 times red LED blinks (x4)	Press SET to save position

IF END POINTS NEED TO BE CHANGED:
Press SET and repeat steps 6-8

IF END POINTS ARE OK:
Press/hold MENU returns to driving mode

IF END POINTS ARE OK:
Press SET returns to driving mode

IF END POINTS ARE OK:
Press SET returns to driving mode

IF END POINTS ARE OK:
Press SET returns to driving mode

IF END POINTS ARE OK:
Press SET returns to driving mode

IF END POINTS ARE OK:
Press SET returns to driving mode

IF END POINTS ARE OK:
Press SET returns to driving mode

IF END POINTS ARE OK:
Press SET returns to driving mode

IF END POINTS ARE OK:
Press SET returns to driving mode

Programming your TQi Transmitter with your Apple iPhone, iPad, iPod touch, or Android Mobile Device

The Traxxas Link™ Wireless Module (part #6511, sold separately) for the TQi transmitter installs in minutes to transform your Apple® iPhone®, iPad®, iPod touch®, or Android™ device into a powerful tuning tool that allows you to replace the transmitter's button/LED programming system with an intuitive, high-definition, full-color graphical user interface.



Traxxas Link

The powerful Traxxas Link app (available in the Apple App Store™ or on Google Play™) gives you complete control over the operation and tuning of your Traxxas model with stunning visuals and absolute precision. Install Traxxas Link telemetry sensors on the model, and Traxxas Link displays real-time data such as speed, RPM, temperature, and battery voltage.



Intuitive iPhone, iPad, iPod touch, and Android interface

Traxxas Link makes it easy to learn, understand, and access powerful tuning options. Control Drive Effects settings, such as TSM assistance percentage; steering and throttle sensitivity; steering percentage; braking strength; and throttle trim by simply touching and dragging the sliders on the screen.

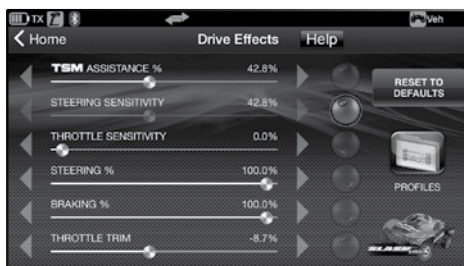

Tap and slide to adjust TSM, Steering Sensitivity, Throttle Trim, Braking Percent, and more!

Real-Time Telemetry

When you equip your model with sensors, the Traxxas Link dashboard comes to life showing you speed, battery voltage, RPM, and temperature. Set threshold warnings and log maximums, minimums, or averages. Use the recording function to document your dashboard view, with sound, so that you can keep your eyes on your driving and not miss a single apex.



The customizable Traxxas Link dashboard delivers real-time RPM, speed, temperature, and voltage data.

Manage up to 30 Models with Traxxas Link

The TQi radio system automatically keeps track of what vehicles it has bound to and what settings were used for each--up to 30 models total! Traxxas Link provides a visual interface to name the models, customize their settings, attach profiles, and lock them into memory. Simply choose a model and any previously bound transmitter, power them up, and start having fun.



Traxxas Link Model Memory simplifies organizing your collection of vehicles.

The Traxxas Link Wireless Module is sold separately (part #6511).

The Traxxas Link application is available from the Apple App store for iPhone, iPad, or iPod touch and on Google Play for Android devices. iPhone, iPad, iPod touch, or the Android device are not included with the Traxxas Link Wireless Module.

For more information about the Traxxas Link Wireless Module and the Traxxas Link application, visit Traxxas.com.



Compatible with:
iPod touch (5th generation and later)
iPad mini
iPad Pro

iPad 2
iPad Air
iPhone 4s (and later)
Android 4.4 (and later)

Apple, the Apple logo, iPhone, iPad, and iPod touch are trademarks of Apple Inc., registered in the U.S. and other countries. App Store is a service mark of Apple Inc. Android and Google Play are trademarks of Google Inc.