

# ix14

**Instruction Manual**

## NOTICE

All instructions, warranties and other collateral documents are subject to change at the sole discretion of Horizon Hobby, LLC. For up-to-date product literature, visit [www.horizonhobby.com](http://www.horizonhobby.com) or [www.towerhobbies.com](http://www.towerhobbies.com) and click on the support or resources tab for this product.

## MEANING OF SPECIAL LANGUAGE

The following terms are used throughout the product literature to indicate various levels of potential harm when operating this product:

**WARNING:** Procedures, which if not properly followed, create the probability of property damage, collateral damage, and serious injury OR create a high probability of superficial injury.

**CAUTION:** Procedures, which if not properly followed, create the probability of physical property damage AND a possibility of serious injury.

**NOTICE:** Procedures, which if not properly followed, create a possibility of physical property damage AND a little or no possibility of injury.



**WARNING:** Read the ENTIRE instruction manual to become familiar with the features of the product before operating. Failure to operate the product correctly can result in damage to the product, personal property and cause serious injury.

This is a sophisticated hobby product. It must be operated with caution and common sense and requires some basic mechanical ability. Failure to operate this Product in a safe and responsible manner could result in injury or damage to the product or other property. This product is not intended for use by children without direct adult supervision. Do not attempt disassembly, use with incompatible components or augment product in any way without the approval of Horizon Hobby, LLC. This manual contains instructions for safety, operation and maintenance. It is essential to read and follow all the instructions and warnings in the manual, prior to assembly, setup or use, in order to operate correctly and avoid damage or serious injury.

## **Age Recommendation: Not for children under 14. This is not a toy.**

### **SAFETY PRECAUTIONS**

- Always ensure all batteries have been properly charged prior to using the model.
- Always check all servos and their connections prior to each run.
- Never operate your model near spectators, parking areas or any other area that could result in injury to people or damage of property.
- Never operate your model during adverse weather conditions. Poor visibility can cause disorientation and loss of control of your model.
- Never point the transmitter antenna directly toward the model. The radiation pattern from the tip of the antenna is inherently low.
- If, at any time during the operation of your model, you observe any erratic or abnormal operation, immediately stop operation of your model until the cause of the problem has been identified and corrected.

## CHARGING WARNINGS



**CAUTION:** All instructions and warnings must be followed exactly.

Mishandling of Li-Po batteries can result in a fire, personal injury and/or property damage.

- **NEVER LEAVE CHARGING BATTERIES UNATTENDED.**
- **NEVER CHARGE BATTERIES OVERNIGHT.**
- By handling, charging or using the included Li-Po battery, you assume all risks associated with lithium batteries.
- If at any time the battery begins to balloon or swell, discontinue use immediately. If charging or discharging, discontinue and disconnect. Continuing to use, charge or discharge a battery that is ballooning or swelling can result in fire.

- Always store the battery at room temperature in a dry area for best results.
- Always transport or temporarily store the battery in a temperature range of 40–120° F (5–49° C). Do not store the battery or model in a car or direct sunlight. If stored in a hot car, the battery can be damaged or even catch fire.
- Always charge batteries away from flammable materials.
- Always inspect the battery before charging.
- Always disconnect the battery after charging and let the charger cool between charges.
- Always constantly monitor the temperature of the battery pack while charging.
- **ONLY USE A CHARGER SPECIFICALLY DESIGNED TO CHARGE LI-PO BATTERIES.** Failure to charge the battery with a compatible charger may cause a fire resulting in personal injury and/or property damage.
- Never discharge Li-Po cells to below 3V under load.
- Never cover warning labels with hook and loop strips.
- Never charge batteries outside recommended levels.

- Never charge damaged batteries.
- Never attempt to dismantle or alter the charger.
- Never allow minors to charge battery packs.
- Never charge batteries in extremely hot or cold places (recommended between 40–120° F [5–49° C]) or place in direct sunlight.

 **WARNING AGAINST COUNTERFEIT PRODUCTS:** If you ever need to replace your Spektrum receiver found in a Horizon Hobby product, always purchase from Horizon Hobby, LLC or a Horizon Hobby authorized dealer to ensure authentic high-quality Spektrum product. Horizon Hobby, LLC disclaims all support and warranty with regards, but not limited to, compatibility and performance of counterfeit products or products claiming compatibility with DSM or Spektrum technology.

**NOTICE:** This product is only intended for use with unmanned, hobby-grade, remote-controlled vehicles and aircraft. Horizon Hobby disclaims all liability outside of the intended purpose and will not provide warranty service related thereto.



# TABLE OF CONTENTS

## How To Use the Manual

Navigating the Pages

Return To Spektrum AirWare App

Using the Table of Contents

## Box Contents

## Basic Operation

Setting Up A New Model overview

## Transmitter Functions

## Spektrum LED

## Charging

## Physical Transmitter Adjustments

Gimbal Adjustment Screws

Transmitter Mode Change

Stick Tension

Throttle Strap Adjustment

Control Sticks

Control Stick Length Adjustment

## Android Operating System

Android Navigation Icons

Android Home Screen Elements

Notification Screen

## Spektrum AirWare Navigation

Volume Control

Telemetry Reset

Model Image Selection

## Model Type Defaults

Acro Defaults

Heli Defaults

Sail Defaults

Multi Defaults

## Model Utilities

Select A Different Model

Add A New Model

Sort Model List

Import Models

Export Models

Edit Categories

Search the Model List

## Model Details

Model Name

Model Image

Monitor Channel Count

Model Category

Expanded Model Details

Reset Model Timer

Duplicate Model

Reset Model

Delete Model

Import Audio

Export Model

Save As Template

Model Note

## **Binding**

Spektrum Failsafe Types

Binding And Programming Failsafe

Testing Failsafe

## **Auto Switch Select**

## **Active Boxes**

Active Box Custom Setup

## **My List**

## **MODEL ADJUST**

## **Servo Setup**

Reverse

Travel

Sub Trim

Speed

Absolute Travel

Balance

## **Dual Rates and Expo**

## **Throttle Cut**

## **Throttle Curve**

Adding and Deleting Curve Points

Heli, Sail and Multicopter Throttle Curve

Throttle Hold

Practical Throttle Curve Example

## **Video Tx**

## **Mixing**

Resetting A Programmable Mix

Offset

Trim

Combo Mixing

Understanding Mixing

0.5 Mixing Values

Back Mixing

**Sailplane Pre-Configured Mixes**

**Forward Programming**

**AS3X®**

**Differential**

**V-Tail Differential**

**Flap System**

**Pitch Curve**

Acro Pitch Curve

**Swashplate**

Electronic E-Ring

Elevator Compensation

**Gyro**

Heli Gyro

Acro Gyro

3-Axis Gyro

Single Axis Gyro

**Governor**

**Tail Curve**

**Camber Preset**

**Camber System**

In-flight camber control

In-flight braking

Camber System Programming

## MODEL SETUP

### Bind

### Timers

### Frame Rate

### Spektrum Telemetry

Auto-Configuring Telemetry At Binding

Using Spektrum Telemetry

Telemetry screen Configuration

Telemetry Sensors

### Analog Switch Setup

### Sleep Mode

Spektrum LED Indicator

### Digital Switch Setup

Switch Status

Switch Assignments

### Audio Events

Switch Change Reports

Custom Reports

Touch Switch Reports

Adjusting Touch Switch Sensitivity

Trim Reports

Trim Release Report

Telemetry Warnings

Stepping Reports

Trainer State Reports

Center Tone

Model Start Alerts

Pre-Flight Checklist

System Sounds

Spoken Flight Mode

Binding Alerts

Timer Reports

## **Channel Assign**

Channel Input Configuration

Receiver Port Assignments

## **Trainer**

Wired Trainer

Wireless Trainer

Trainer Alerts

Instructor Transmitter Configuration

Binding Wireless Trainer

Head Tracking FPV Setup

Focal Channel Assignments

## **Range Test**

Flight Log Data

Guidelines for DSM2 Installations

Guidelines for DSMX Installations

Receiver Installation

## **Model Start Warnings**

## **Serial Port Setup**

Serial Port Protocol

Spektrum RF

Serial Port Power (9.5v)

## **Aircraft Type**

## **Aircraft Type (Airplane)**

Swashplate Type (Helicopter)

Sailplane Type (Sailplane)

Aircraft Type (Multirotor)

## **Flight Mode Setup**

Examples of Flight Mode Applications

Using Flight Mode Setup

Hold (Helicopter)

## **Trim Setup**

Cross Trims

## **SYSTEM SETTINGS**

### **System Configuration**

### **Product Information**

### **Calibration**

Touch Sensitivity

## **Regulatory Information**

### **TROUBLESHOOTING GUIDE**

### **FAQS**

### **1-Year Limited Warranty**

### **Warranty and Service Contact Information**

### **FCC Information**

### **IC Information**

### **Compliance Information for the European Union**

## HOW TO USE THE MANUAL

The manual for the iX14 is an interactive **.pdf** document, optimally viewed in the .pdf viewer app on the Android.

To access the manual from Spektrum AirWare app:

1. Touch the System Settings button from the home screen.
2. Long-press the Manual button. A dialogue appears prompting to download the latest Manual.
3. Touch **PROCEED** to download the latest version of the manual. The manual opens in the .pdf viewer.

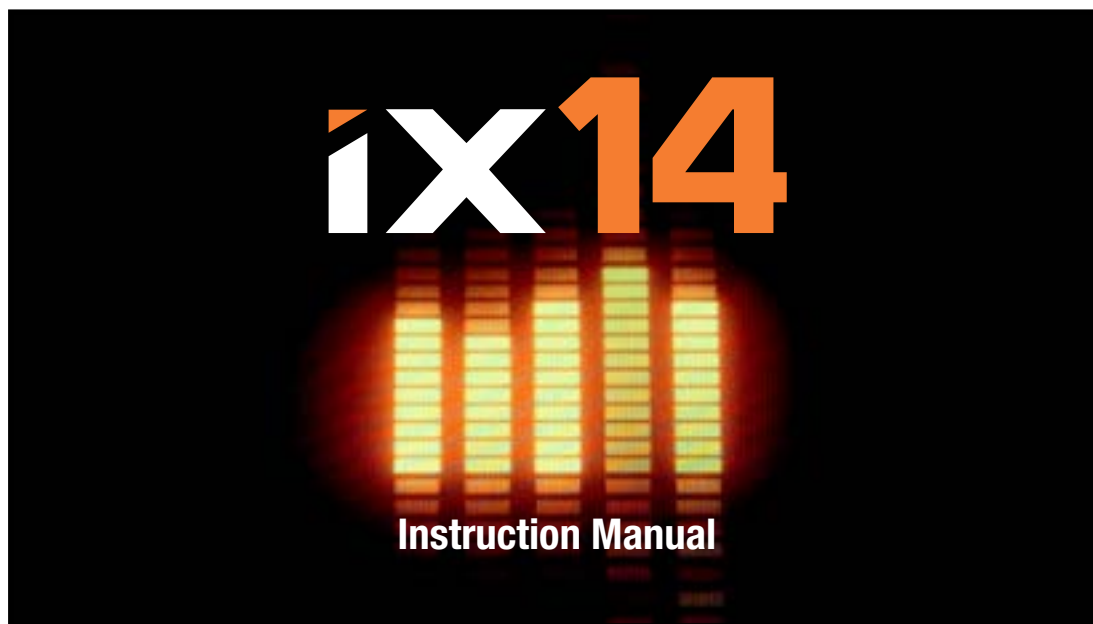



# NAVIGATING THE PAGES

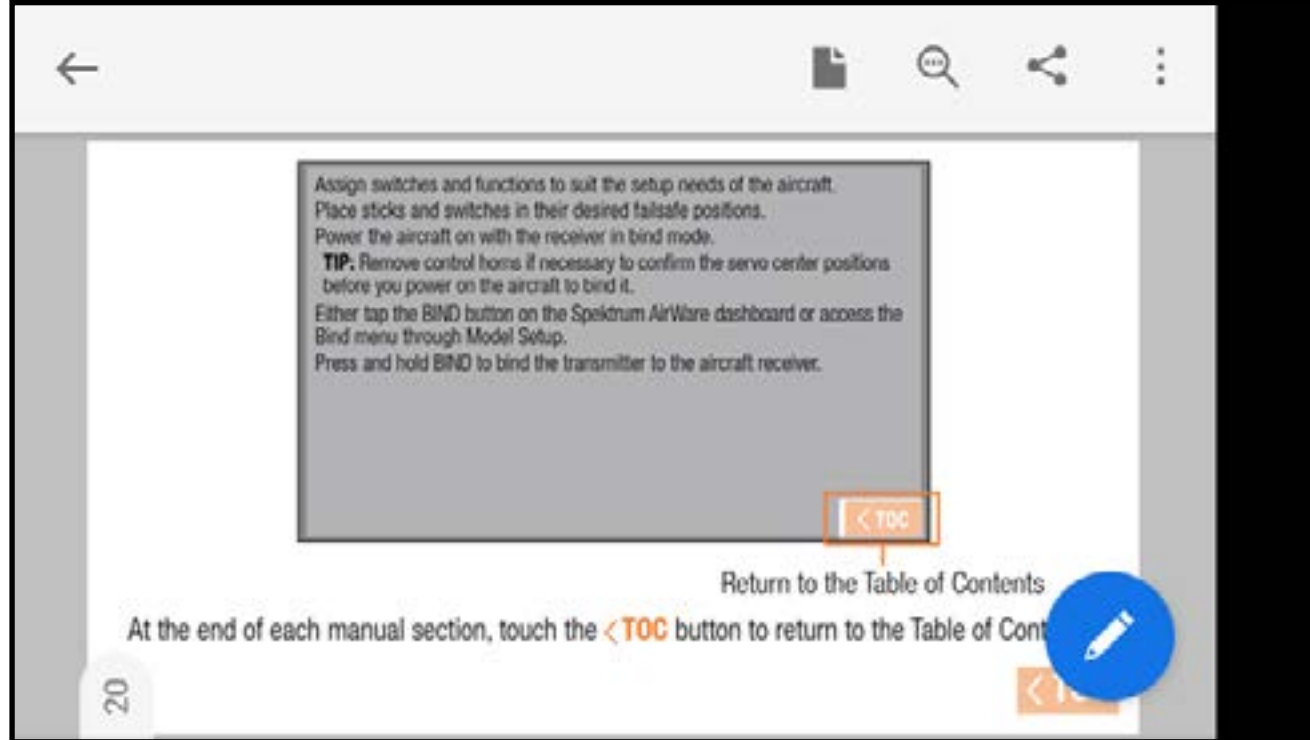

1. Touch the middle of the screen once to access the reader app toolbars.
2. Touch the page icon (📄) to set the viewing mode.

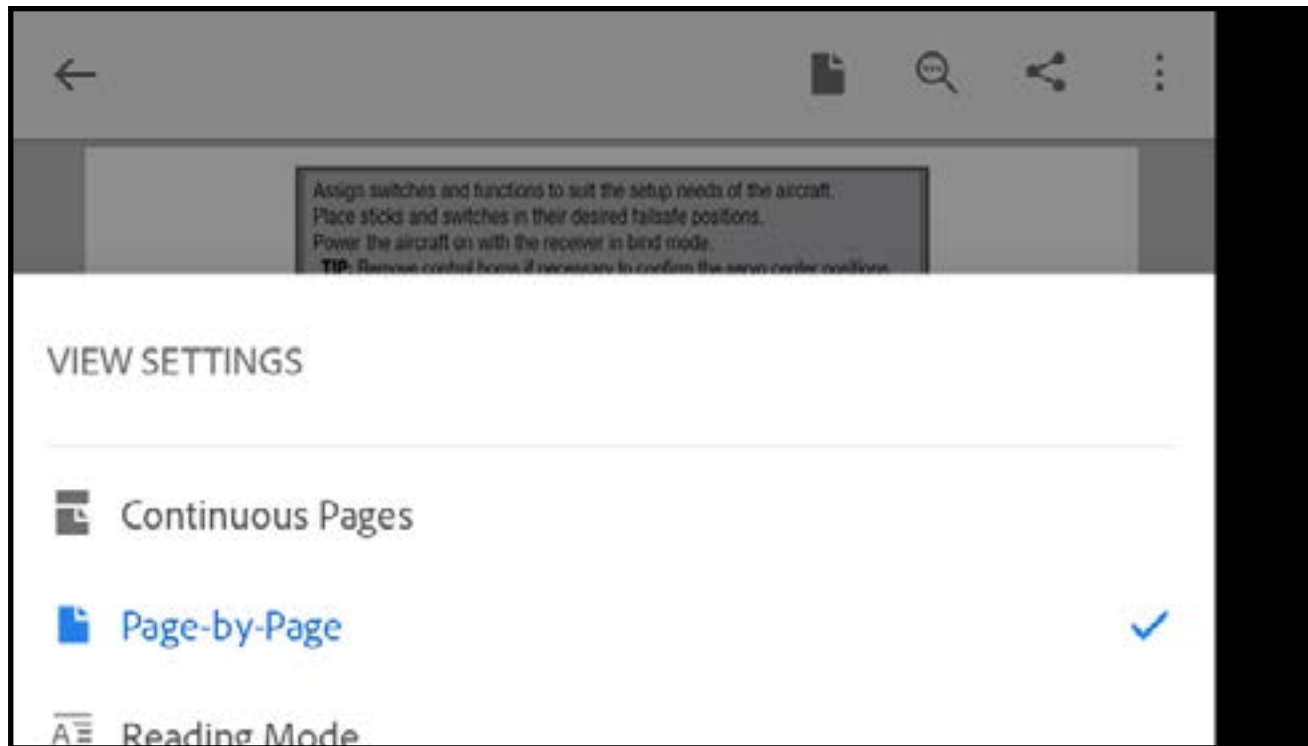

3. Select **Page-by-Page** for best viewing results.
4. After the viewing mode is set, touch in the center of the screen to enter full-screen mode.
5. Touch toward the far right side of the screen or swipe left to go the next page.  
Touch toward the far left side of the screen or swipe right to go to the previous page.

## RETURN TO SPEKTRUM AIRWARE APP

To return to the Spektrum AirWare app:

1. Swipe from the top or right side of the screen to access the Android navigation tools.
2. Touch the **Overview** icon.
3. Touch the Spektrum AirWare app in the list of running apps.



Overview icon

# USING THE TABLE OF CONTENTS

TABLE OF CONTENTS	
Box Contents	Model Type Defaults
Basic Operation	Acro Defaults
Setting Up A New Model	Heli Defaults
Transmitter Functions	Sail Defaults
Spektrum LED	Multi Defaults
Charging	<b>Model Utilities</b>
Android Operating System	Select A Different Model
Android Navigation Icons	Add A New Model
Android Home Screen Elements	Import Models
Notification Screen	Export Models
Android Quick Start Guide	Sort Model List
Spektrum AirWare™ Navigation	<b>Model Details</b>
Volume Control	Model Name

The Table of Contents is fully interactive. Touch an entry to go directly to that page.

Assign switches and functions to suit the setup needs of the aircraft.  
Place sticks and switches in their desired failsafe positions.

Power the aircraft on with the receiver in bind mode.

**TIP:** Remove control horns if necessary to confirm the servo center positions before you power on the aircraft to bind it.

Either tap the BIND button on the Spektrum AirWare dashboard or access the Bind menu through Model Setup.

Press and hold BIND to bind the transmitter to the aircraft receiver.



< TOC

Return to the Table of Contents

At the end of each manual section,  
touch the < **TOC** button to return to the Table of Contents.



< TOC

## BOX CONTENTS

The iX14 radio system is supplied with the following:

- Spektrum iX14 Transmitter
- 10,500mAh Li-Ion Transmitter Battery Pack (Installed)
- Quick Start Guide
- USB magnetic adapter cable with magnetic USB-C adapter
- iX14 Neck Strap
- iX14 Decal Sheet
- iX14 Foam Carrying Case

## BASIC OPERATION

The iX14 transmitter is based on an Android operating system. All RC related functions are handled by the Spektrum AirWare™ application.

- **Power On:** Press and hold the power button for several seconds to power on the iX14 transmitter. The transmitter is designed to prevent inadvertently powering on from a touch to the power button. After the transmitter is on, the Android operating system will take approximately 1 minute to boot up. The Spektrum AirWare app will automatically launch. Do not attempt to open other applications while the Spektrum AirWare app is launching. When the application has finished launching, the Spektrum AirWare home screen will be displayed. The Android operating system may then be accessed to utilize other apps.
- **Power Off:** Press and hold the power button for several seconds to access the shutdown menu. Select either **“Power off”** or **“Restart”** from the popup menu. Power off will power off the iX14. Restart will restart the iX14.

- **WiFi Connection:** Swipe down from the top of the screen and click on the WiFi icon to connect to available WiFi networks. Spektrum AirWare app updates and firmware updates for the radio hardware are available through the Google Play Store. Internet access through a WiFi access point is required. After logging into the Google Play Store, any available updates will automatically download.

**IMPORTANT:** To use the Android Screen Lock feature, WiFi must be turned off for the setting to take effect.

- **System Configuration:** Press the System Settings button at the bottom right of the home screens. Touch the System Configuration button to define the user name, stick mode, language and battery and inactivity alarm settings.

- **Sleep Modes:** The iX14 may be used like similar smart devices that stay powered for long periods of time. Powering the transmitter off between flights is not necessary. Double tap the power button to bring up the **SLEEP MODE** menu. Switch the radio signal (RF), Screen and Bluetooth on or off and press and hold **APPLY** or simply press and hold the **QUICK SLEEP** button to put all functions into sleep mode. Press the Power button once to wake the system from Sleep Mode.



**IMPORTANT:** The first time a double tap is used to bring up the **SLEEP MODE** screen, the iX14 may ask the operator for administrator privileges. Press accept to give the Spektrum AirWare app permission to put the screen to sleep.



**WARNING:** Turning off the RF causes the iX14 to stop sending control signals. Do not turn off the RF when a model is powered on and connected to the transmitter.

- **Screen Sleep Mode:** Tap the Power button once to put the screen to sleep. The radio will continue to transmit RC control signals.
- The transmitter has enough battery power for approximately 6 hours of use. Fully charging the battery requires approximately 6 hours.
- Any time the iX14 needs to turn off the RF transmission, it will display a warning. Press and hold **PROCEED** to power off the RF transmission and continue programming.

## SETTING UP A NEW MODEL OVERVIEW

Each model type has its own set of default settings to match the application. See the **Model Type** section of this manual for the default assignments in each model type. Default settings include switch assignments for auxiliary channels and flight modes, voice alerts, timers and the channel output assignments on the receiver.

Out of the box, the transmitter will have one Acro model stored in the model memory. Use this default or create a new model. Tap in the upper left corner of the Spektrum AirWare app main screen and press and hold **PROCEED** to go to the Model Utilities menu. From there, you can add a new airplane, helicopter, sailplane, or multicopter model by touching the expand icon (  ) in the top right of the screen.

After selecting the model type and before binding, tap the **Model Setup** button from the main screen in the Spektrum AirWare app to access the model setup options.

The most critical setup option is **Aircraft Type** which defines many pre-configured options such as specialized mixing for multi servo wings, swashplates for helicopters and other aircraft type-specific options. These options vary significantly between aircraft types, and this should be set prior to binding.

Assign switches and functions to suit the aircraft setup needs.

Place sticks and switches in their desired failsafe positions.

With the receiver in bind mode, power on the aircraft.

**TIP:** Remove control horns if necessary to confirm the servo center positions before you power on the aircraft to bind it.

Either tap the **BIND** button on the Spektrum AirWare dashboard or access the **Bind** menu through **Model Setup**.

Press and hold **BIND** to bind the transmitter to the aircraft receiver.

# TRANSMITTER FUNCTIONS

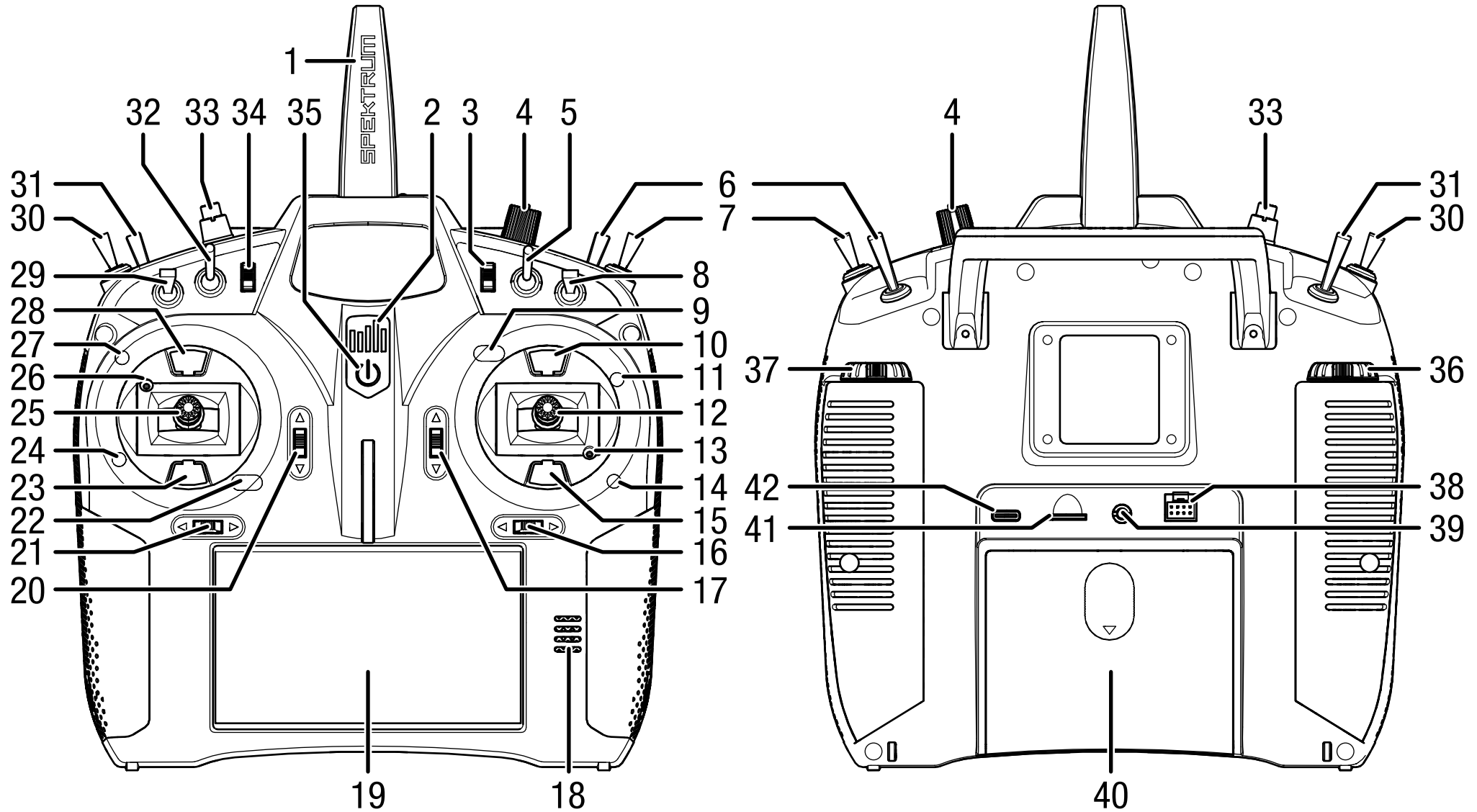

	<b>Function</b>
1	Antenna
2	LED
3	Right Trim
4	Right Knob
5	Switch E
6	Switch H
7	Switch G
8	Switch F
9	Throttle Tension and Ratchet Adjustment (Mode 1,3)
10	Throttle Limit Switch (Mode 1,3)
11	Mode Change Screw

	<b>Function</b>
12	Throttle/Aileron (Mode 1)
	Elevator/Aileron (Mode 2)
	Throttle/Rudder (Mode 3)
	Elevator/Rudder (Mode 4)
13	Left/Right Gimbal Stick Tension Adjustment*
	Up/Down Gimbal Stick Tension Adjustment*
14	Up/Down Gimbal Stick Tension Adjustment*
15	Throttle Limit Switch (Mode 1,3)
16	Aileron Trim (Mode 1,2)
	Rudder Trim (Mode 3,4)
17	Elevator Trim (Mode 2, 4)
	Throttle Trim (Mode 1, 3)

	<b>Function</b>
18	Speaker
19	LCD Touchscreen
20	Elevator Trim (Mode 1,3) Throttle Trim (Mode 2,4)
21	Rudder Trim (Mode 1,2) Aileron Trim (Mode 3,4)
22	Throttle Tension and Ratchet Adjustment (Mode 2,4)
23	Throttle Limit Switch (Mode 2,4)
24	Mode Change Screw

	<b>Function</b>
25	Elevator/Rudder (Mode 1)
	Throttle/Rudder (Mode 2)
	Elevator/Aileron (Mode 3)
	Throttle/Aileron (Mode 4)
26	Left/Right Gimbal Stick Tension Adjustment*
27	Up/down Gimbal Stick Tension Adjustment*
28	Throttle Limit Switch (Mode 2,4)
29	Switch C
30	Switch B
31	Switch A
32	Switch D

	Function
33	Switch I
34	Left Trim
35	Power Button
36	Left Rear Lever
37	Right Rear Lever

	Function
38	Serial Interface Port
39	Audio Jack
40	Battery Cover
41	Micro Memory Card Port
42	USB-C Charge Port

**\* NOTICE:** Always perform a stick tension test while turning the screws to ensure stick tension is not too loose or too tight. Overtightening a screw can damage the spring. Loosening a screw too far can cause a spring to fall out in the transmitter and possibly damage the circuitry within.

## SPEKTRUM LED

The 5-bar LED on the front of the iX14 indicates different transmitter functions.

- The LED glows solid orange when the iX14 is powered on and actively transmitting.
- The LED is off when either the iX14 is powered off or when the RF is in sleep mode with the screen active.
- The LED slowly flashes orange for a short time when both the RF and screen are put into sleep mode.
- The LED glows solid blue when power is supplied through the USB port.
- While charging in sleep mode, the LED will initially flash orange with solid blue, then glow solid blue.



## CHARGING

For optimum charging results, the built-in charger requires a USB power supply capable of at least 2-3A output. Using a power supply with a lower output will result in very long charge times or the transmitter not charging if it is powered on while attempting to charge.

The first time the transmitter is charged, the charge time may be 6-7 hours. Charge the transmitter when the low battery alarm sounds. See the **System Settings** section for information on setting the low battery alarm level.

Always charge the transmitter on a heat-resistant surface.

 **CAUTION:** Never change the low voltage limit for Li-Ion batteries below 3.3V. Doing so could over-discharge the battery and damage both battery and transmitter.

 **CAUTION:** Never leave a charging battery unattended.

 **CAUTION:** Never charge the battery outside of the transmitter. Charging the battery outside of the transmitter may interfere with the battery monitoring system, which can give false low battery warnings.

1. Connect a 2-3A USB power supply (not included) to an AC outlet.
2. Connect the included magnetic USB charging cable to the power supply.
3. Insert the included magnetic USB-C adapter in the USB port on the back of the transmitter.
4. Connect the USB charging cable to the magnetic adapter.
5. The LED will glow solid blue while charging and stays on while connected to power. A fast press of the power switch will bring the Charge Battery icon to the color touch screen display.
6. Charging is complete when the button is pressed and the battery capacity icon on the screen shows full. Disconnect the USB cable once charging is complete. Disconnect the power supply from the power outlet. The magnetic USB-C adapter can be left in the transmitter USB port for future use.

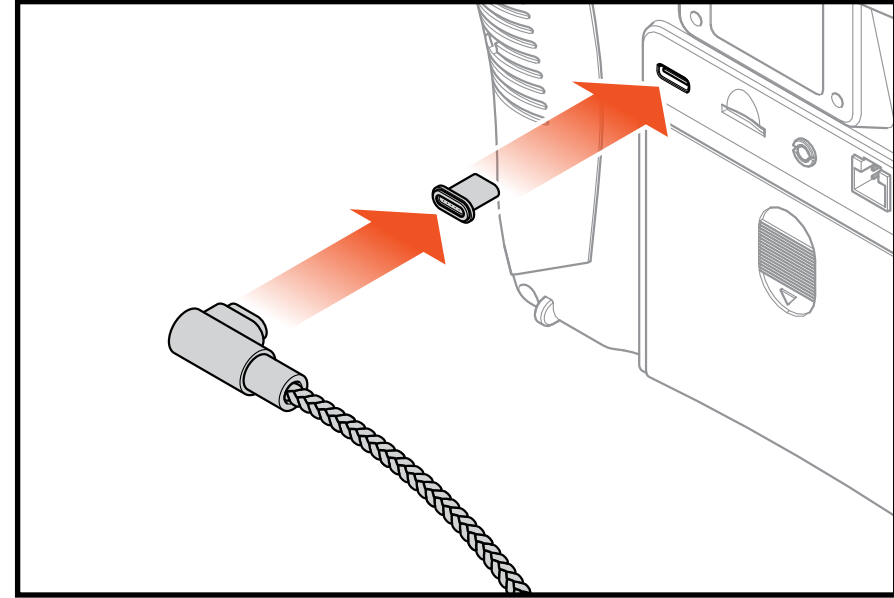

## PHYSICAL TRANSMITTER ADJUSTMENTS

The adjustment points for the iX14 are located around the face of each gimbal.\* This arrangement allows for quick and easy adjustment without removing the back cover.

The available adjustments include:

- Mode Change
- Throttle Ratchet
- Throttle Tension
- Stick Tension

**NOTICE:** Always perform a stick tension test while turning the screws to ensure stick tension is not too loose or too tight. Overtightening a screw can damage the spring. Loosening a screw too far can cause a spring to fall out in the transmitter and possibly damage the circuitry within.

\*The gimbal adjustment screws are covered by small rubber plugs. Carefully remove these plugs prior to making adjustments. The plugs are not interchangeable. Ensure to note from where each plug is removed and replace them accordingly.

# GIMBAL ADJUSTMENT SCREWS

<b>1</b>	Centering
<b>2</b>	Ratchet Set
<b>3</b>	Tension Set

<b>4</b>	Vertical Spring Tension
<b>5</b>	Horizontal Spring Tension
<b>6</b>	Throttle Limit Switch

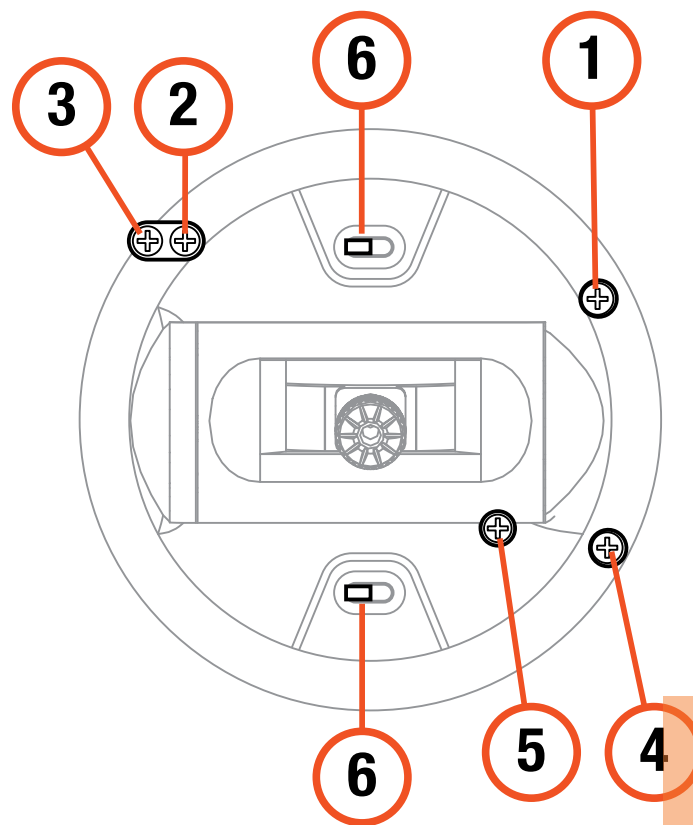
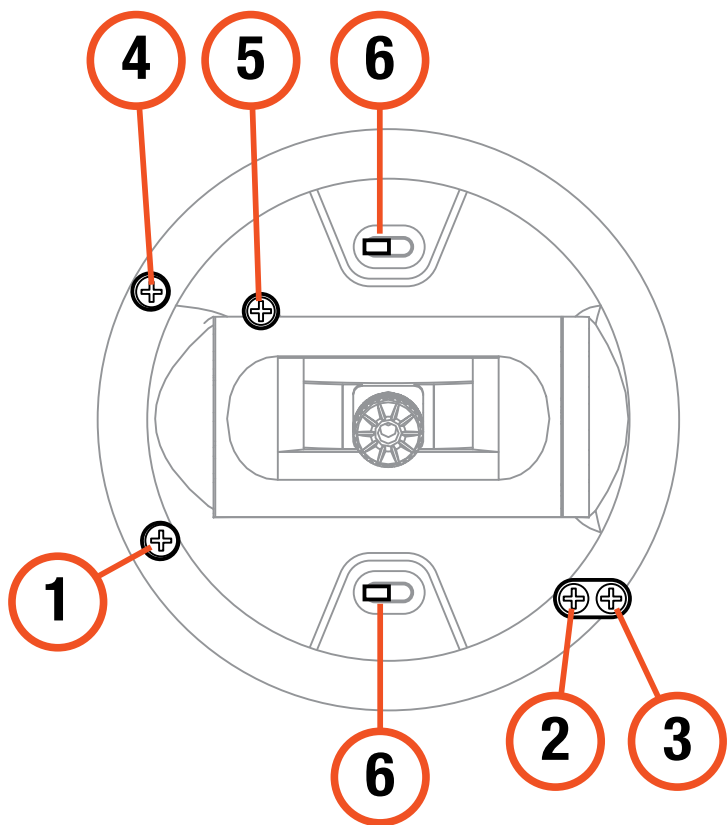

## TRANSMITTER MODE CHANGE

Mode 2 is the default transmitter control mode for the iX14. The transmitter is capable of converting to modes 1, 3 or 4 as well. This conversion requires both a programming and mechanical adjustment.

The conversion consists of the following steps:

- Programming Conversion
- Change the Throttle Ratchet
- Adjust the Gimbal Centering Screw
- Move the Throttle Limit Switches
- Calibration

## PROGRAMMING CONVERSION

See the System Setup, System Configuration section to select the control layout mode. If changing between modes 2 and 4 or 1 and 3, no physical gimbal changes are required.

## CHANGE THE THROTTLE RATCHET

1. Locate the throttle strap adjustment screws on both gimbals. The ratchet set screw engages a serrated section on the gimbal for a ratcheted throttle, while the tension set screw engages a strap for smooth tension on the gimbal.
2. To engage the throttle ratchet, using a small Phillips screwdriver, turn the ratchet set screw clockwise until the ratchet engages.
3. To disengage the throttle ratchet, using a small Phillips screwdriver, turn the screw counterclockwise until the gimbal moves freely.



## ADJUST THE GIMBAL CENTERING SCREW

When changing between Modes 1 and 2, or between Modes 3 and 4, the gimbal centering screw must be adjusted on both gimbals to enable the centering spring on the elevator gimbal and disable it on the throttle gimbal.

1. Use a small Phillips screwdriver to tighten the gimbal centering screw. Tightening the screw will disengage the centering spring.
2. Using a small Phillips screwdriver, loosen the opposite gimbal centering screw until the lever engages.

## THROTTLE LIMIT ADJUSTMENT FOR TRANSMITTER MODE CHANGE

Throttle limiting is used to limit the maximum travel of the throttle stick when changing between modes 1 and 2, or between modes 3 and 4.

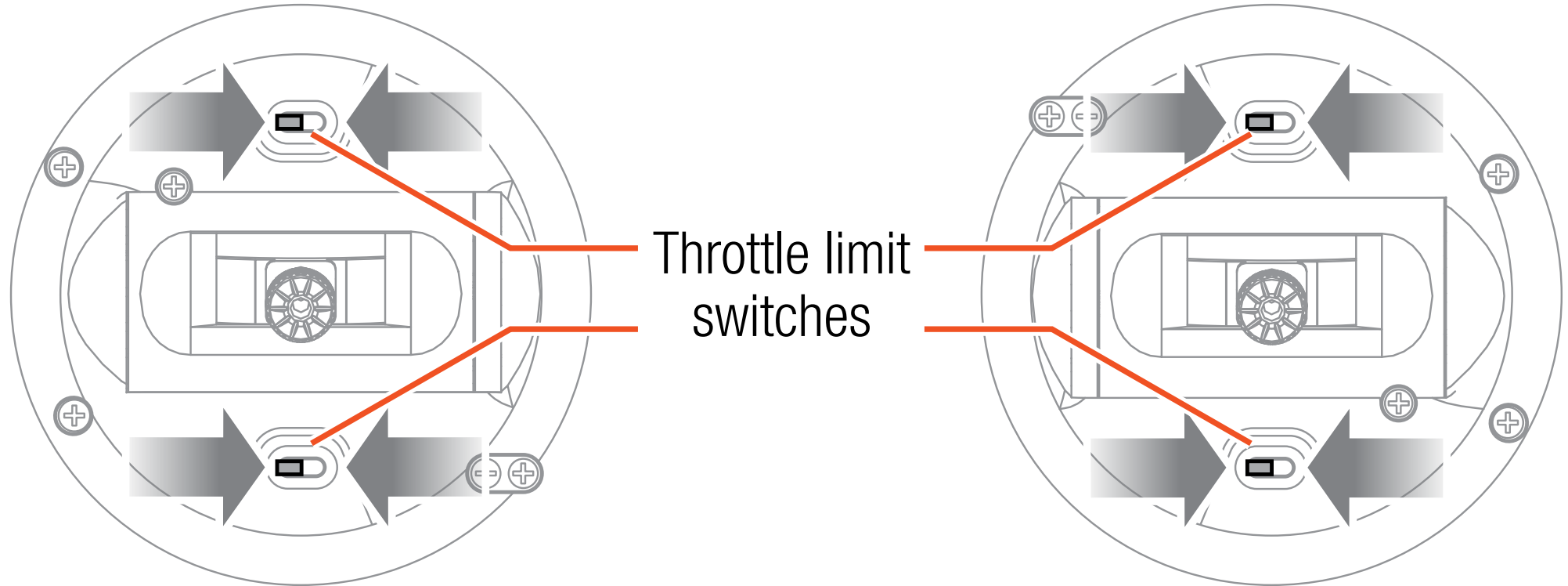

1. To disengage throttle limiting on the current throttle gimbal, remove the plastic switch covers above and below the gimbal.

2. Slide the throttle limit switch to the opposite side of its current position.
3. Replace the plastic switch covers.
4. To engage throttle limiting on the desired gimbal, remove the plastic switch covers above and below the gimbal.
5. Slide the throttle limit switch to the opposite side of its current position.
6. Replace the plastic switch covers.

## CALIBRATION

After changing the mode, cycle the power of the iX14. When it powers on, a calibration screen will be displayed. Move every control to the extreme and return them to center. The indicator will turn green when the range of each control has been accepted; the control must be centered for the indicator to stay green. Select Save when all the indicators are green.

## STICK TENSION

Turn the screws clockwise a small amount using a small Phillips screwdriver to tighten the stick tension and counterclockwise to loosen.

**NOTICE:** Always perform a stick tension test while turning the screws to ensure stick tension is not too loose or too tight. Overtightening a screw can damage the spring. Loosening a screw too far can cause a spring to fall out in the transmitter and possibly damage the circuitry within.

## THROTTLE STRAP ADJUSTMENT

The gimbals on the iX14 can be configured for smooth tension or ratcheted throttle.

### SMOOTH THROTTLE TENSION

1. Locate the throttle strap adjustment screws on the throttle gimbal.
2. Adjust the throttle tension by turning the tension set screw clockwise to tighten or counterclockwise to loosen, using a small Phillips screwdriver.

## RATCHETED THROTTLE

If desired, disengage the smooth throttle strap and engage the ratcheted throttle, using a small Phillips screwdriver.

1. Back the set screw out on the smooth tension strap until the throttle moves freely.
2. Tighten the set screw on the ratchet until it engages the gimbal.
3. Adjust the ratchet tension by turning the set screw clockwise to tighten or counterclockwise to loosen.

**NOTICE:** Overtightening a screw can damage the spring. Loosening a screw too far can cause a spring to fall out in the transmitter and possibly damage the circuitry within.

## CONTROL STICKS

To Change Control Stick Ends:

1. Grasp the lower knurled portion of the stick and loosen the upper knurled portion of the stick.
2. Unscrew the stick and replace it with optional stick ends.
3. Once the new stick end is at the correct height, lock in place by holding the upper knurled portion of the stick and tightening the lower knurled portion against it.



## CONTROL STICK LENGTH ADJUSTMENT

The control sticks are composed of two machined aluminum pieces threaded onto the gimbal.

To adjust the Control Stick Length:

1. Grasp the lower knurled portion of the stick and loosen the upper knurled portion of the stick.
2. Make the stick shorter by turning both portions of the stick clockwise or longer by turning them counterclockwise.
3. Lock the stick length by holding the upper knurled portion of the stick and tightening the lower knurled portion against it.

# ANDROID OPERATING SYSTEM

The iX14 transmitter is built on the Android operating system and features a large color touch screen display. Navigate the iX14 using the same actions and gestures as those used to operate any other Android device.

To navigate, use your finger to tap, swipe and drag icons and menus found on the display.

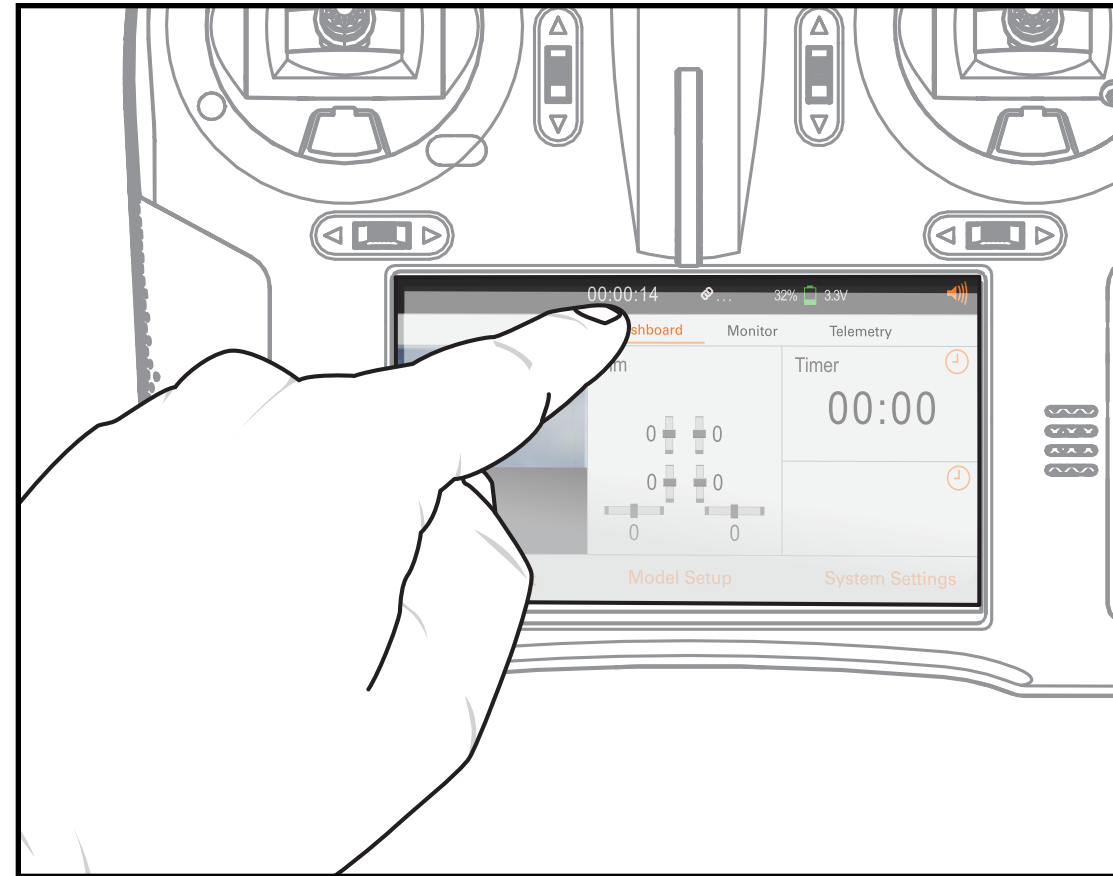

# ANDROID NAVIGATION ICONS

The Spektrum AirWare application will hide the Android home screen navigation icons. To access the Android navigation icons at anytime, swipe down from the top edge of the screen as shown or left from the right side of the screen.

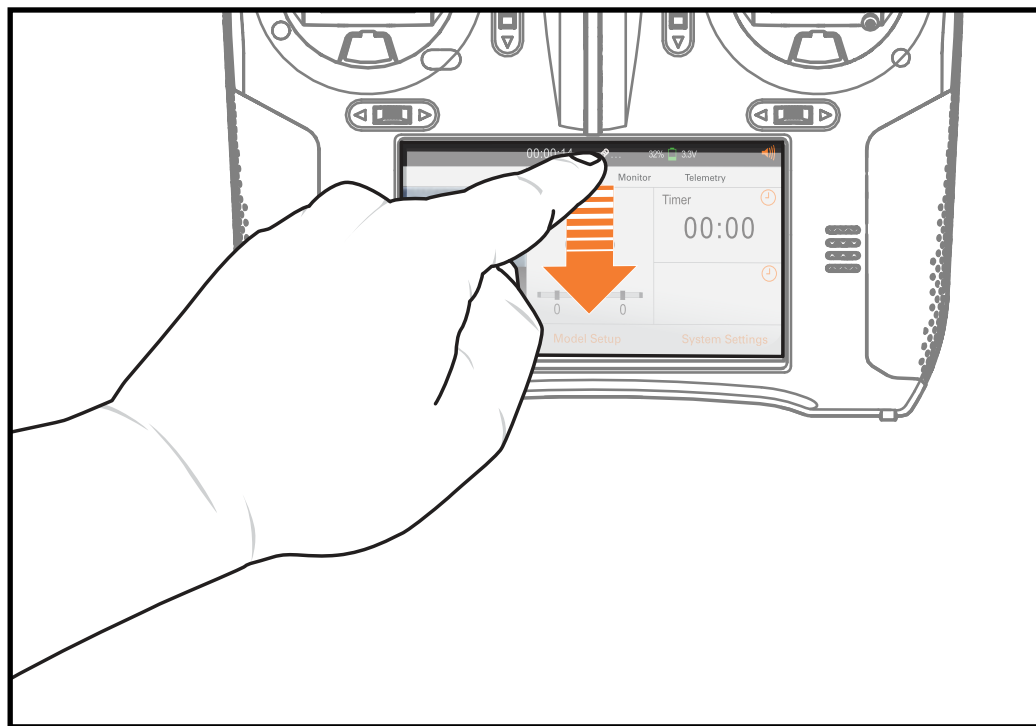

Press the circle icon to go to the Android home screen.

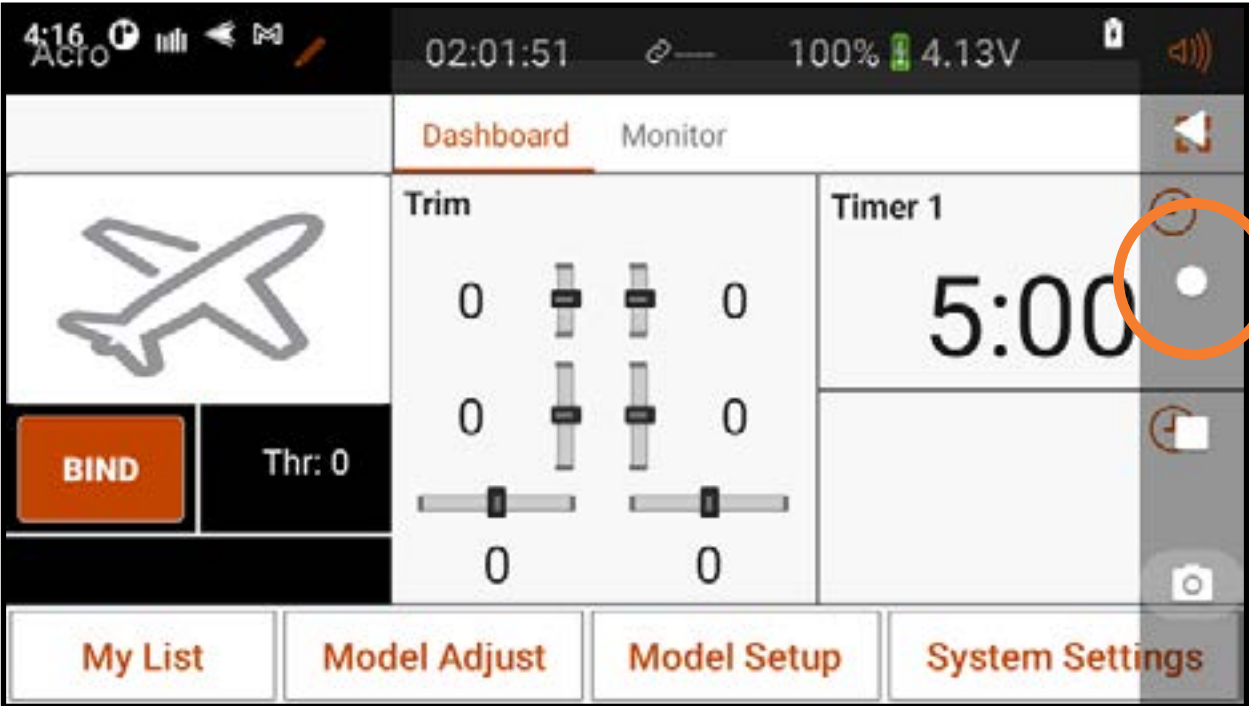

Circle icon

# ANDROID HOME SCREEN ELEMENTS

- 1. All Apps:** Swipe up from the bottom to access a list of the apps loaded on the iX14.
- 2. Back:** Return to previous screen.
- 3. Home:** Return to the home screen.
- 4. Overview:** Allows switching between any active applications. Remove any apps from the active list by swiping up.



## NOTIFICATION SCREEN

1. Swipe down from the top of the screen once to exit full screen mode and bring the home screen navigation icons to the front.
2. Swipe down a second time to roll down the Notification Screen for quick access to:
  - Brightness
  - WiFi
  - Bluetooth
  - Settings

# SPEKTRUM AIRWARE NAVIGATION

The iX14 Spektrum AirWare app has up to four main screens that can be quickly accessed by swiping left or right on the touch screen display. The Dashboard and Monitor screens are always available. Telemetry Dashboard and Telemetry Min/Max are only available when telemetry information is present.

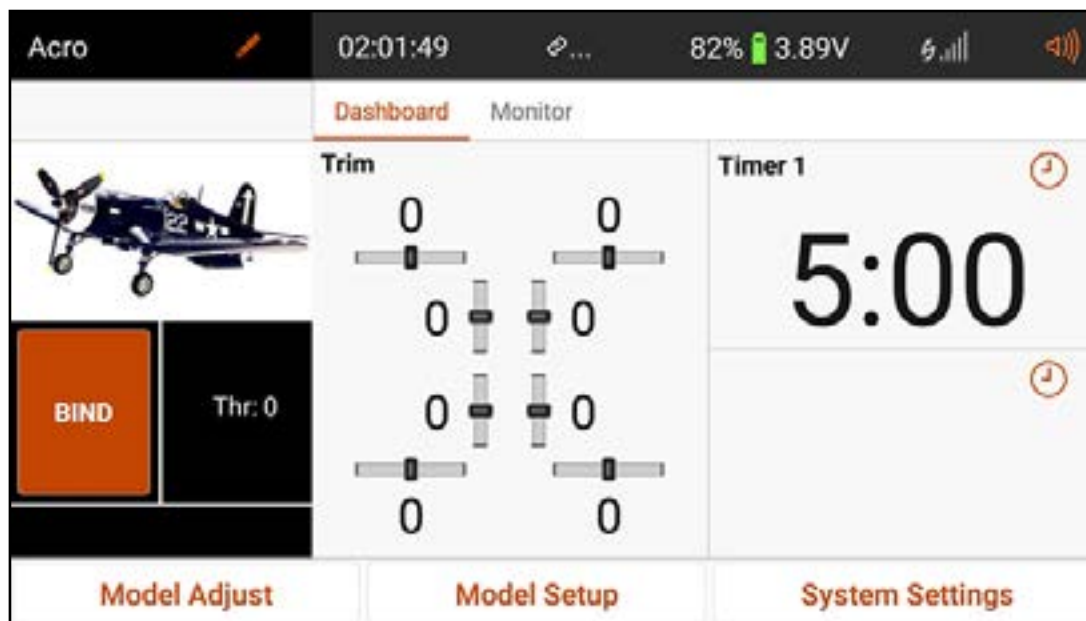

- **Dashboard:** The main screen displaying Trims and Timers, as well the model name and image.

The Dashboard and the other main screens contain common information and navigation options to access various functions of the iX14 transmitter.

Long press to return to Dashboard from any other main screen

Battery capacity and voltage

Telemetry Signal Strength: Long press to reset telemetry data

Touch for Model Utilities menu **OR** long press to access Model Select to change the active model

Long press to access the Select Model Image menu

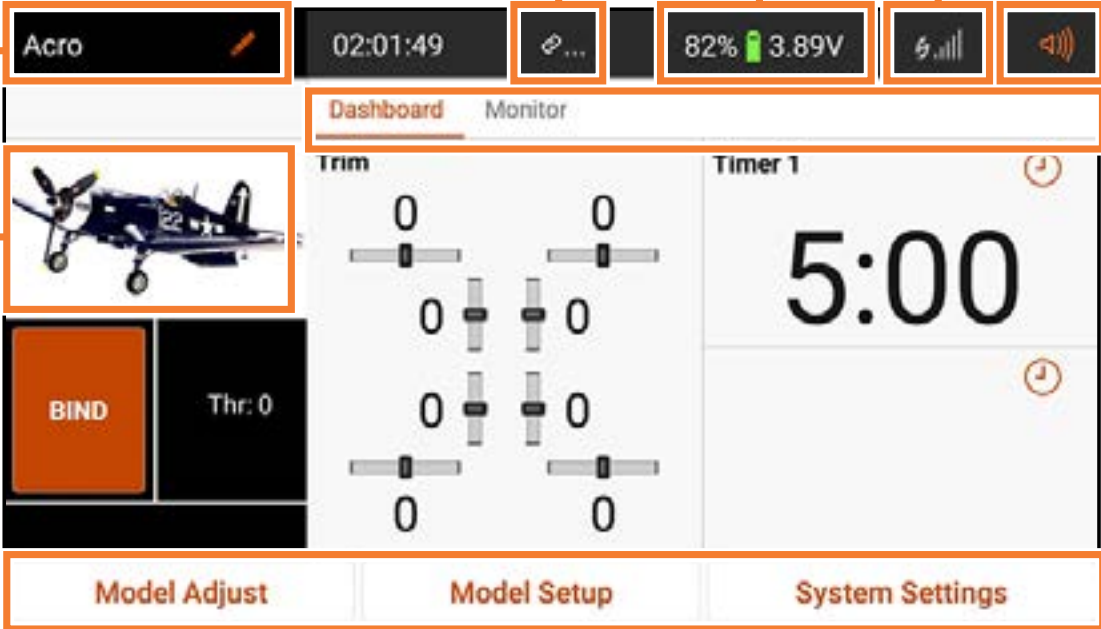

Volume

Active main screen: Touch or sweep screen left or right to change

Spektrum Airware navigation buttons



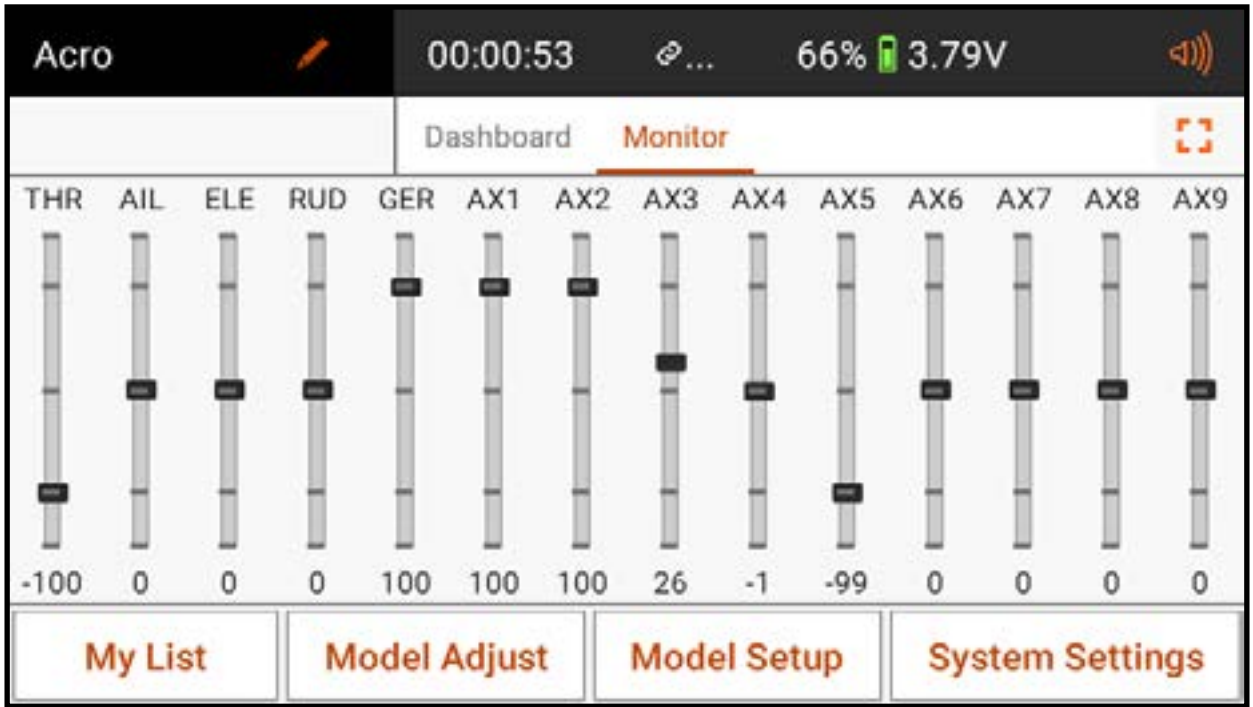

- **Monitor:** Graphically displays all current control inputs in real time.

Timber			01:20:51	DSMX	56%	3.74V	Signal	Speaker
Dashboard			Monitor	Telemetry	Flight Log	Min/Max	Rx Pa	
Trans. Batt. %	RX Voltage	FlightLog Frame Loss						
56%	7.6 V	0						
FlightLog Holds								
0								
Model Adjust	Model Setup	System Settings						

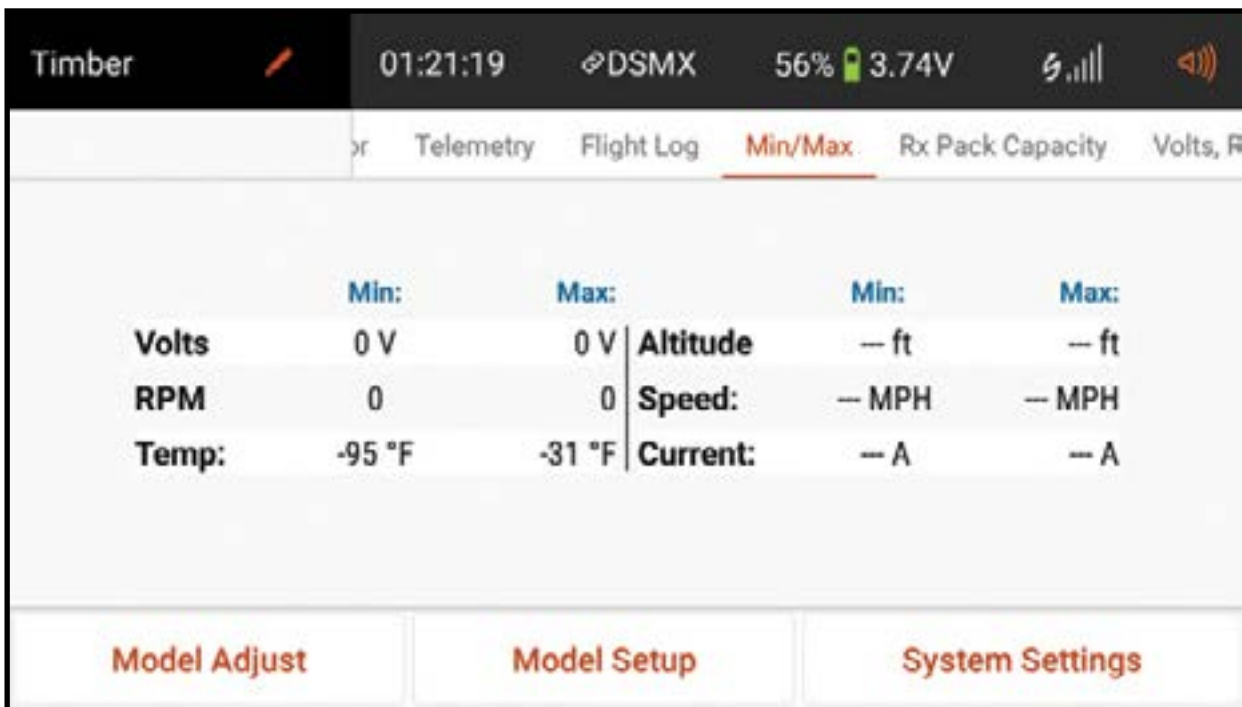

- **Telemetry Dashboard\*:** Displays telemetry information for each sensor. User selects which items to display on this page from the Telemetry setup menu. Additional telemetry pages are available when activated in the telemetry setup menu.



- **Telemetry Min/Max\*:** Logs the minimum and maximum values collected from each telemetry sensor.

\*Only available if telemetry is active and the transmitter is bound to a telemetry receiver.

## VOLUME CONTROL

- Touch the Volume icon (  ) in the top right corner of any of the main screens to access the iX14 Volume menu.
- Move the slider up and down to adjust the volume.
- Touch the Mute button (  ) to silence all sounds within the Spektrum AirWare app.

## TELEMETRY RESET

When the transmitter is bound to a telemetry receiver, telemetry signal strength bars appear in the main screen top bar (  ). Long press the strength bars to reset the telemetry flight data and erase the min/max data.

## MODEL IMAGE SELECTION

To change the model image from the dashboard screen:

1. Touch and hold the model image.
2. Select an image from the stock images, select **PICK AN IMAGE FROM THE GALLERY** to choose a file from the Android images gallery folder.

**TIP:** Image files should be 266 x 164 pixels, however the system will stretch the image file to fit. Image files should be saved in **.jpg** format.

## MODEL TYPE DEFAULTS

When a new model is created, the iX14 assigns a baseline configuration, which includes warnings, timers, channel input configuration (switch assignments), receiver port assignments (channel assignments), flight modes, and menu options all based on the model type selected.

The four model types available include:

- Airplane (Acro)
- Helicopter (Heli)
- Sailplane (Sail)
- Multirotor (Multi)

Consult the aircraft manual for more information on specific aircraft setup requirements.

## ACRO DEFAULTS

- Throttle position warning at 10%.
- 5:00 minute timer set to count down from throttle stick movement above 25%.

### **Switch Assignments**

A- Gear

B- Aux 2

C- N/A

D- Aux 1

E- N/A

F- N/A

G- N/A

H- N/A

R Knob- Aux 3

Left Slider- Aux 4

Right Slider- Aux 5

Left Trimmer- N/A

Right Trimmer- N/A



# Channel Assignments

1. Throttle
2. Aileron
3. Elevator
4. Rudder
5. Gear
6. Aux 1
7. Aux 2
8. Aux 3
9. Aux 4
10. Aux 5
11. Aux 6
12. Aux 7
13. Aux 8
14. Aux 9

## HELI DEFAULTS

- Throttle position warning at 10%.
- 5:00 minute timer set to count down from throttle output above 25%.
- Flight modes are called Stunt Modes in Heli. Flight Mode 0 is Normal, Flight Mode 1 is Stunt 1 and Flight Mode 2 is Stunt 2.

### **Switch Assignments**

A- N/A

B- Flight Mode

C- N/A

D- Gear

E- Aux 2

F- N/A

G- N/A

H- N/A

R Knob- Aux 3

Left Slider- Aux 4

Right Slider- Aux 5

Left Trimmer- N/A

Right Trimmer- N/A

# Channel Assignments

1. Throttle
2. Aileron
3. Elevator
4. Rudder
5. Gear
6. Pitch
7. Aux 2

8. Aux 3
9. Aux 4
10. Aux 5
11. Aux 6
12. Aux 7
13. Aux 8
14. Aux 9

## SAIL DEFAULTS

- Throttle position warning at 10% if the motor option is enabled in the Sailplane Type menu in Model Setup.
- 5:00 minute timer set to activate with Switch I.
- Flight modes are called Launch, Cruise and Land if flight modes are assigned, no default flight mode assignments.

### Switch Assignments

A- Gear

B- N/A

C- N/A

D- Aux1

E- Aux 2

F- N/A

G- N/A

H- N/A

R Knob- Aux 3

Left Slider- Aux 4

Right Slider- Aux 5

Left Trimmer- Inhibit

Right Trimmer- Inhibit

# Channel Assignments

1. Inhibit
2. Aileron
3. Elevator
4. Rudder
5. Gear
6. Aux 1
7. Aux 2
8. Aux 3
9. Aux 4
10. Aux 5
11. Aux 6
12. Aux 7
13. Aux 8
14. Aux 9

## MULTI DEFAULTS

- Throttle position warning at 10%.
- 5:00 minute timer set to count down from throttle stick movement above 25%.

### **Switch Assignments**

A- Gear

B- N/A

C- N/A

D- Aux 1

E- Aux 2

F- N/A

G- N/A

H- N/A

R Knob- Aux 3

Left Slider- Aux 4

Right Slider- Aux 5

Left Trimmer- N/A

Right Trimmer- N/A

# Channel Assignments

1. Alti
2. Roll
3. Pitch
4. Yaw
5. Gear
6. Aux 1
7. Aux 2
8. Aux 3
9. Aux 4
10. Aux 5
11. Aux 6
12. Aux 7
13. Aux 8
14. Aux 9

# MODEL UTILITIES

The Model Utilities menu is accessed by touching the model name at the top left corner of the home screens in the Spektrum AirWare app. If RF is on, a dialog box will appear to turn off RF. Touch and hold **PROCEED** to continue to the Model Utilities menu.

Touch the ribbon across the top of the screen to view the available models by type or to view all models together.



## WARNING:

Never turn off RF during flight. You will lose control of your aircraft.

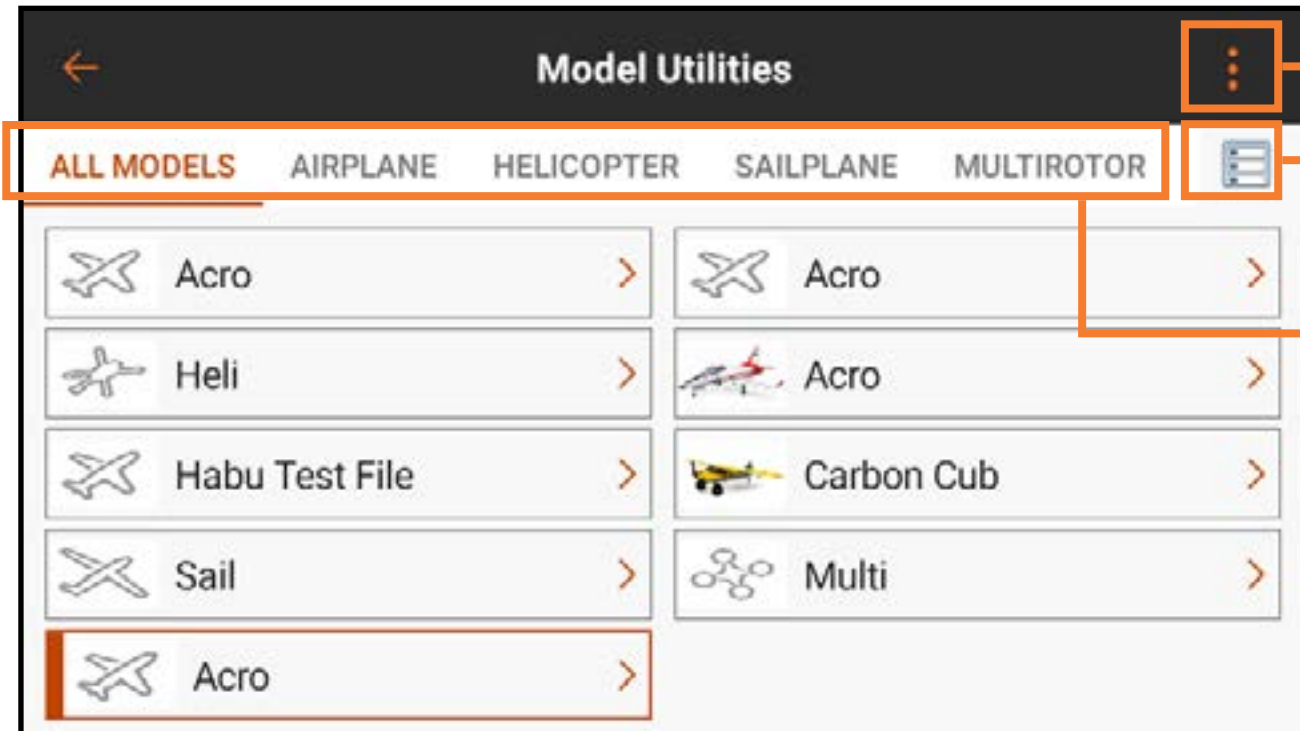

Expand  
List View  
Ribbon



Use the Model Utilities Screen to:

- Select a Different Model
- Add a New Model
- Sort Model List
- Import Models
- Export Models
- Edit the Model Categories
- Search the Model List

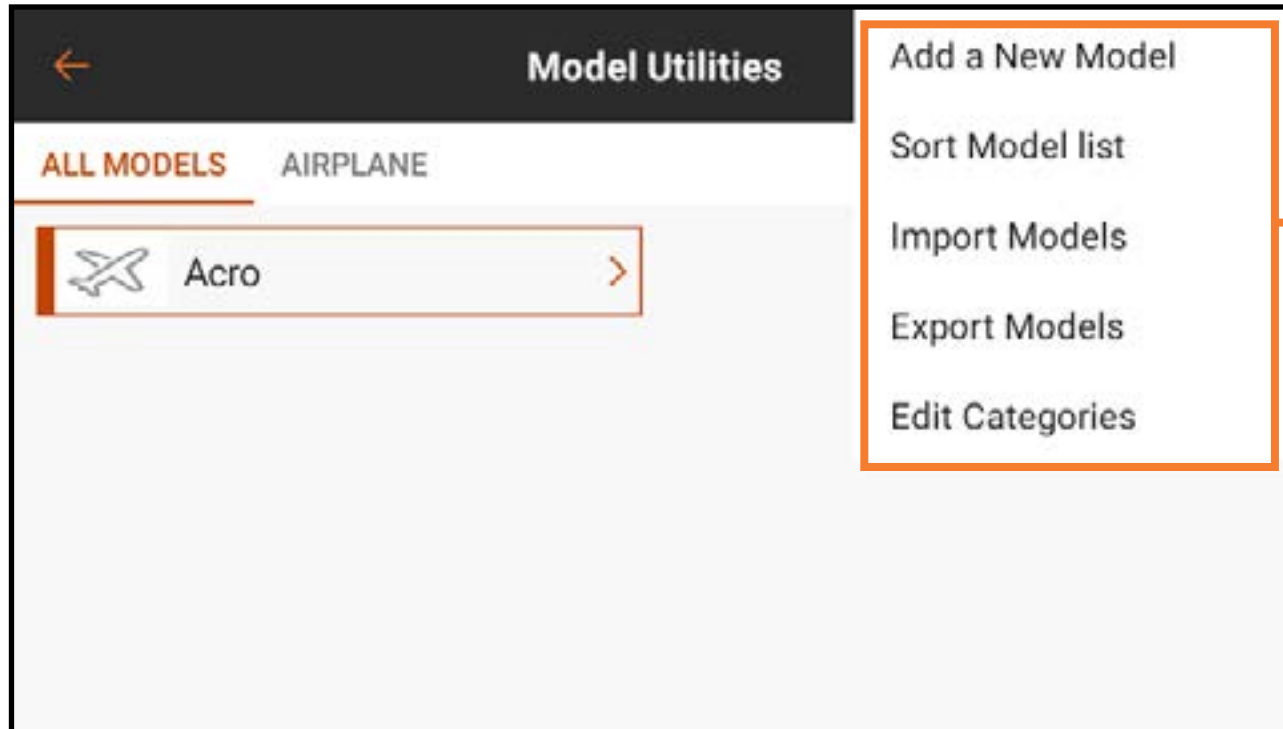

Expanded menu options

# LIST VIEW

Touch the list view icon to change between the large list view and the two column model list view.

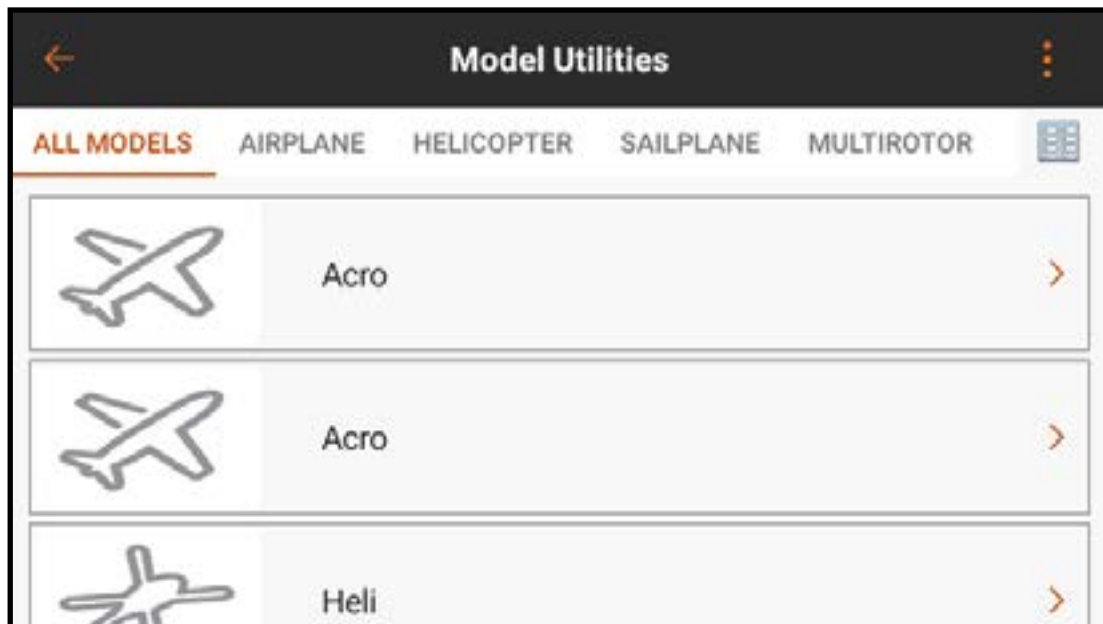

Large List View

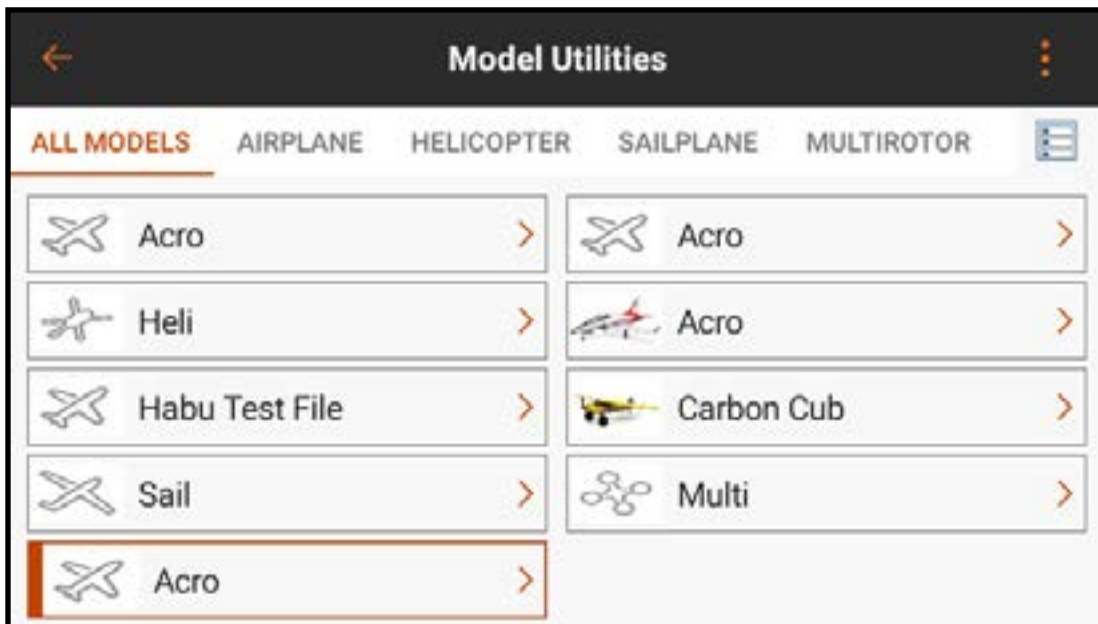

Double List View

## SELECT A DIFFERENT MODEL

The active model appears in the model list with an orange outline around it.

To change the active model from the Model Utilities menu list:

1. Touch the model to be activated on menu list. The Model Details screen for the selected model is displayed.
2. Touch **SELECT/ACTIVATE MODEL** to activate the model. A blue check appears to indicate the model is active. All of the options for the model within the Model Details are now available.
3. Press the back arrow ( ← ) at the top left of the screen to return to the Model Utilities screen and again to exit to the home screen, or press and hold the back arrow ( ← ) to return directly to the home screen.

## ADD A NEW MODEL

1. Touch the expand icon (☰) at the top right corner of the Model Utilities screen.
2. Select **Add a New Model** from the drop down menu.
3. Select **Default**, **Template** or **BNF** from the pop up menu. Use Default to create a model using default values for all model settings. Use Template to start from a model template that has been saved to the iX14 transmitter. See the following pages for a description of the BNF template option.
4. Select the desired model option and select **Create** to continue.
5. The iX14 will return to the Model Utilities screen and the new model will be selected. Touch the new model to enter the Model Details screen or touch the back arrow at the top left of the screen to return to the Dashboard.

**TIP:** Set up a generic model in each model type with desired switch assignments, rates, curves, and other details; name the model, and save it as a template.

Future setups can be based on the saved template by selecting Template during the process of adding a new model.

# BNF TEMPLATE

The iX14 includes the option of loading preconfigured BNF templates from the Model Utilities menu.

When you select the **BNF** option from the **Add a New Model** pop up menu, you are given the choice of various bind and fly aircraft, listed by brand.

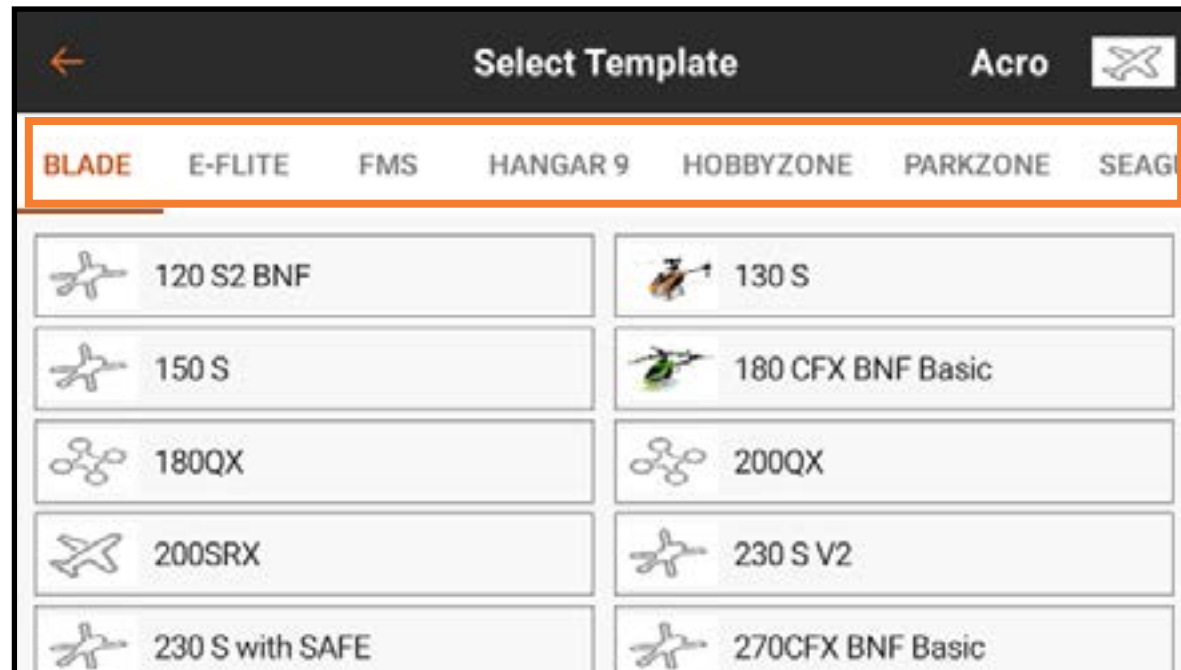

Ribbon

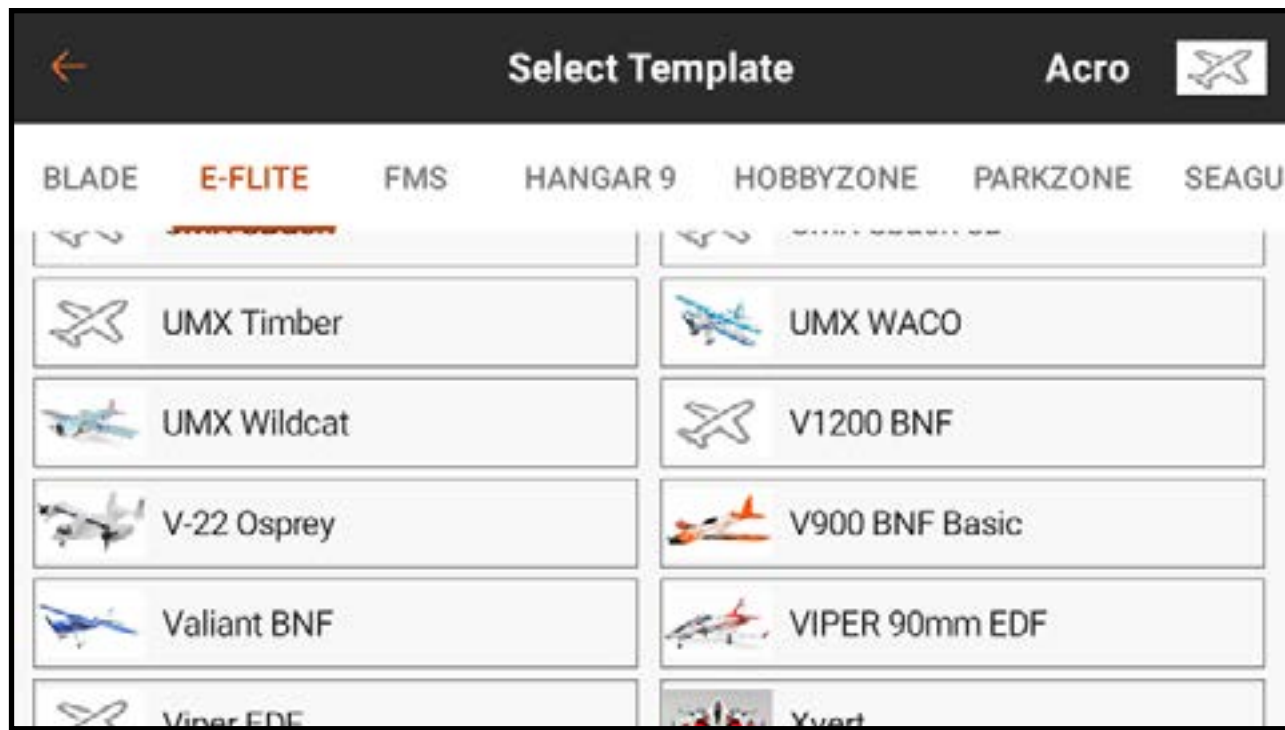

1. Select the brand from the menu ribbon.



2. Select the aircraft from the list. The aircraft template is loaded and added to the bottom of the model utilities list.
3. Select the model from the model utilities list.
4. Touch **SELECT/ACTIVATE MODEL** to activate the model.

## SORT MODEL LIST

To sort the order the models appear on the models list:

1. Touch the expand icon (  ) at the top right corner of the Model Utilities screen.
2. Touch **Sort Model List**.
3. Either select the **A-Z** or **Z-A** options to sort the entire models list alphabetically or select a model to be moved. Use the arrows at the bottom of the screen to move the selected model to the position desired on the list.
4. Press the back arrow (  ) at the top left of the screen to return to the Model Utilities screen and again to exit to the main screen.

# IMPORT MODELS

To import models:

1. Touch the expand icon (  ) at the top right corner of the Model Utilities screen.
2. Select **Import Models** from the drop down menu.
3. Open the desired file(s).



## EXPORT MODELS



To export multiple models:

1. Touch the expand icon (  ) at the top right corner of the Model Utilities screen.
2. Select **Export Models** from the drop down menu.
3. The file extension type is set to **.ispm**. The exported models are only compatible with other Android based, Spektrum AirWare equipped transmitters.
4. Select the model to be exported, or **Select All**.
5. Touch **EXPORT**.
6. An Android menu appears with several options to export the model file. This list may vary depending on third party apps that are installed. Save the file or transfer it via any option that allows file transfers.

## EDIT CATEGORIES

Edit Categories allows you to add su-categories to the model list.

To edit the model list categories:

1. Touch the expand icon (  ) at the top right corner of the Model Utilities screen.
2. Touch **Edit Categories**.
3. Select which category you would like to edit.
4. Touch the (  ) to add a subcategory.
5. Name the new category using the text line, selecting **DONE** when finished.
6. Touch the (  ) to return to the Model Utilities menu.

To add a model to the new subcategory, select the model you wish to add from the Model Utilities list. In the Model Details menu, touch the **Subcategory** button and select the new subcategory from the drop-down list.

## SEARCH THE MODEL LIST

The list of models saved on the transmitter may be searched by a text string from the Model Utilities or Model Select menus.

To search the Model List:

1. With the Model Utilities or Model Select menu active, swipe down from the center of the screen. A text input line appears.
2. Touch on the text input line to access the keyboard.
3. Enter the text to be searched.
4. Touch the search icon on the keyboard. Any model names containing the searched text are listed on the screen.

## MODEL DETAILS

Access the Model Details menu by touching to select a model from the Model Utilities menu list. The model selected must be the active model for the full menu to open. If it is not the active model, touch **SELECT/ACTIVATE MODEL** to activate it.

Use the Model details menu to:

- Change the Model Name
- Change the Model Image
- Change the Monitor Channel Count
- Change the aircraft Category
- Change the aircraft Subcategory
- Designate the model as a Favorite

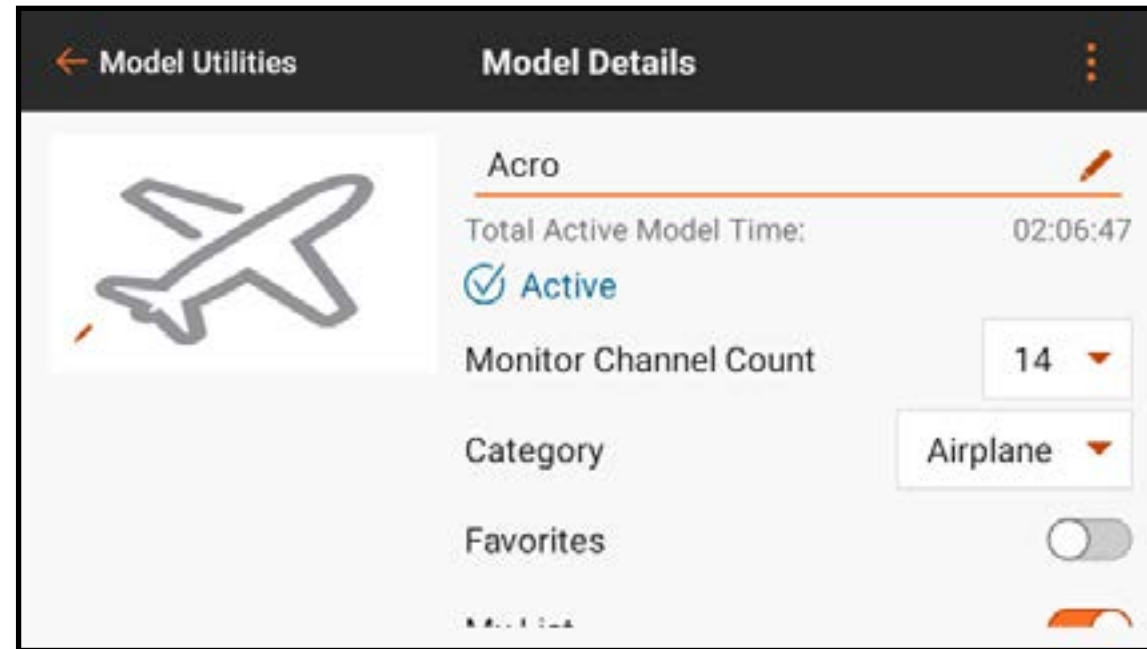

## MODEL NAME

The selected model must be the active model to enable the option to change the model name.

To change the selected model name:

1. Touch in the model name box. The text input screen will appear.
2. Enter up to 20 characters.
3. Touch **DONE** to return to the Model Details menu.

## MODEL IMAGE

The model image can be changed on any model from the model utilities list, including models that are not active.

To change the model image:

1. Touch the model image.
2. Select an image from the stock images, select **PICK AN IMAGE FROM THE GALLERY** to choose a file from the Android images gallery folder.

**TIP:** Image files should be 266 x 164 pixels, however the system will stretch the image file to fit. Image files should be saved in **.jpg** format.

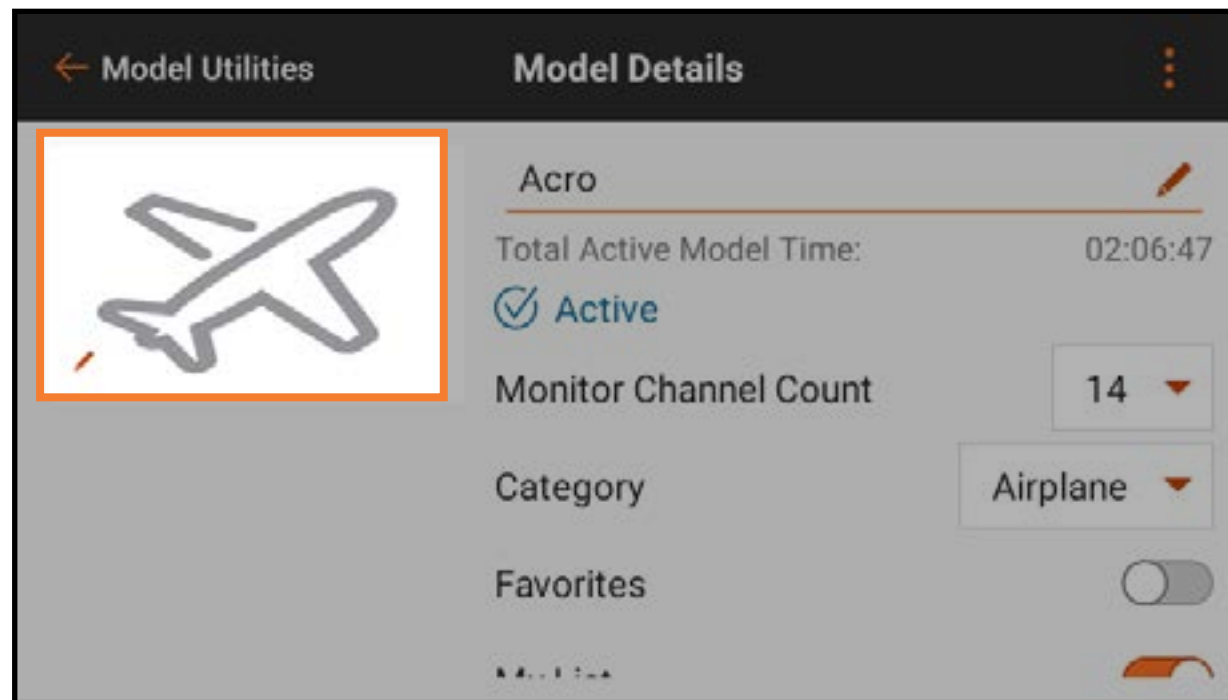

# MONITOR CHANNEL COUNT

Select the number of channels to display on the main monitor screen.

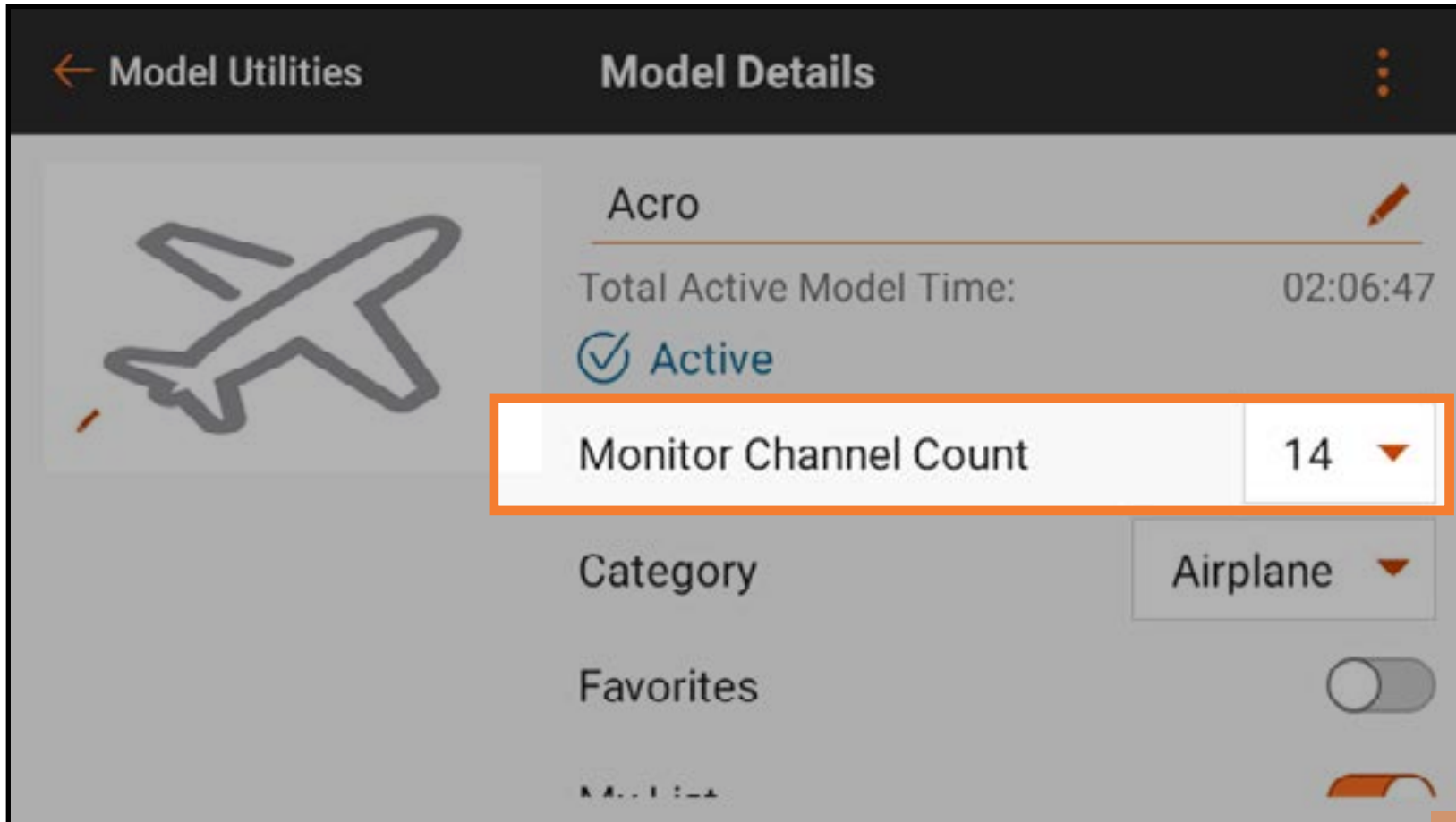

# MODEL CATEGORY

Select the desired model category.

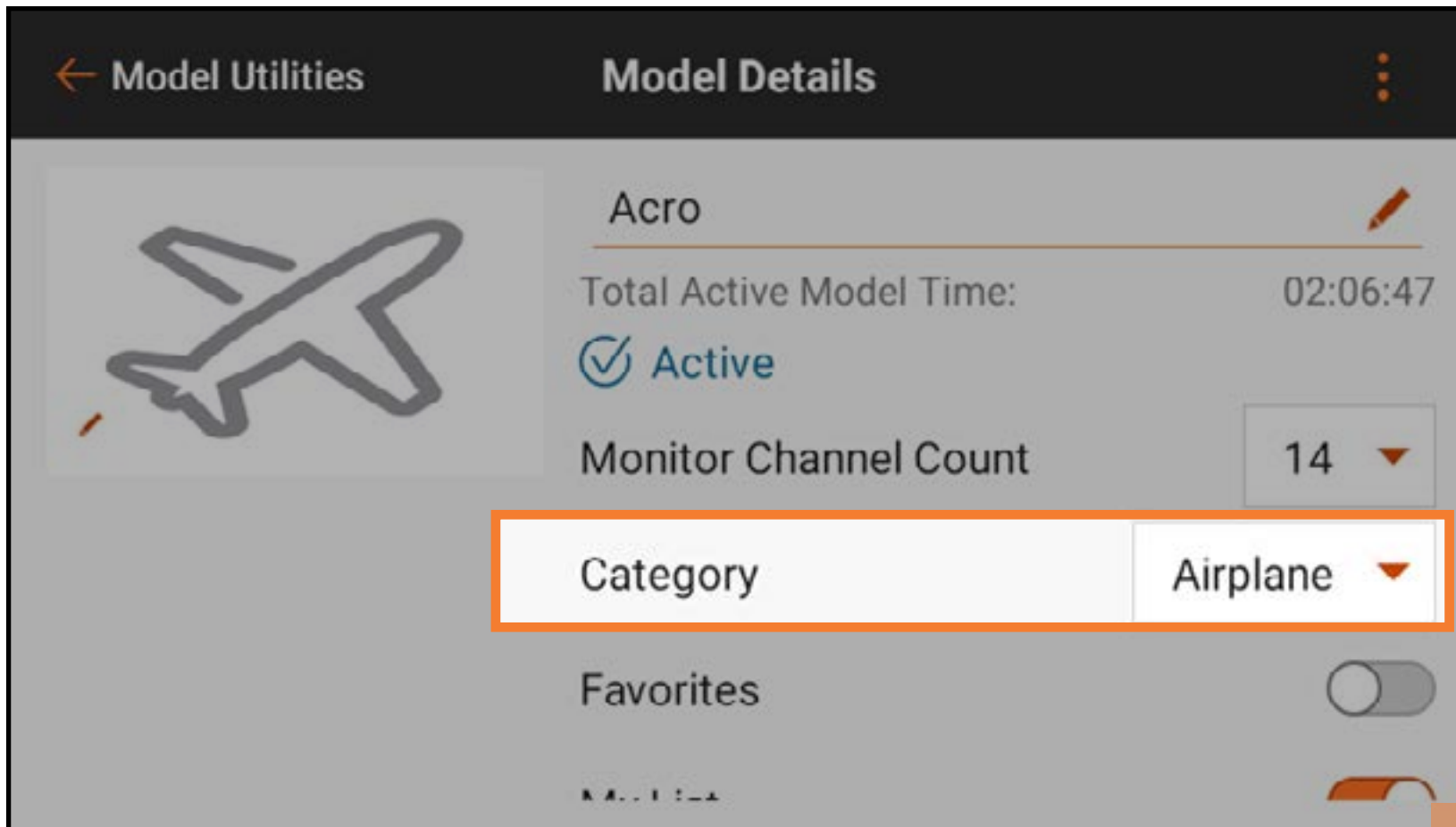



## EXPANDED MODEL DETAILS

Touch the expand icon (⋮) at the top right corner of the Model Details screen for a scrollable list of additional options. These options affect the selected model and vary whether the model selected is active.

Options in the drop down menu include:

- Reset Model Timer
- Import Audio
- Duplicate Model
- Reset Model
- Delete Model
- Export Model
- Save As Template
- Model Note

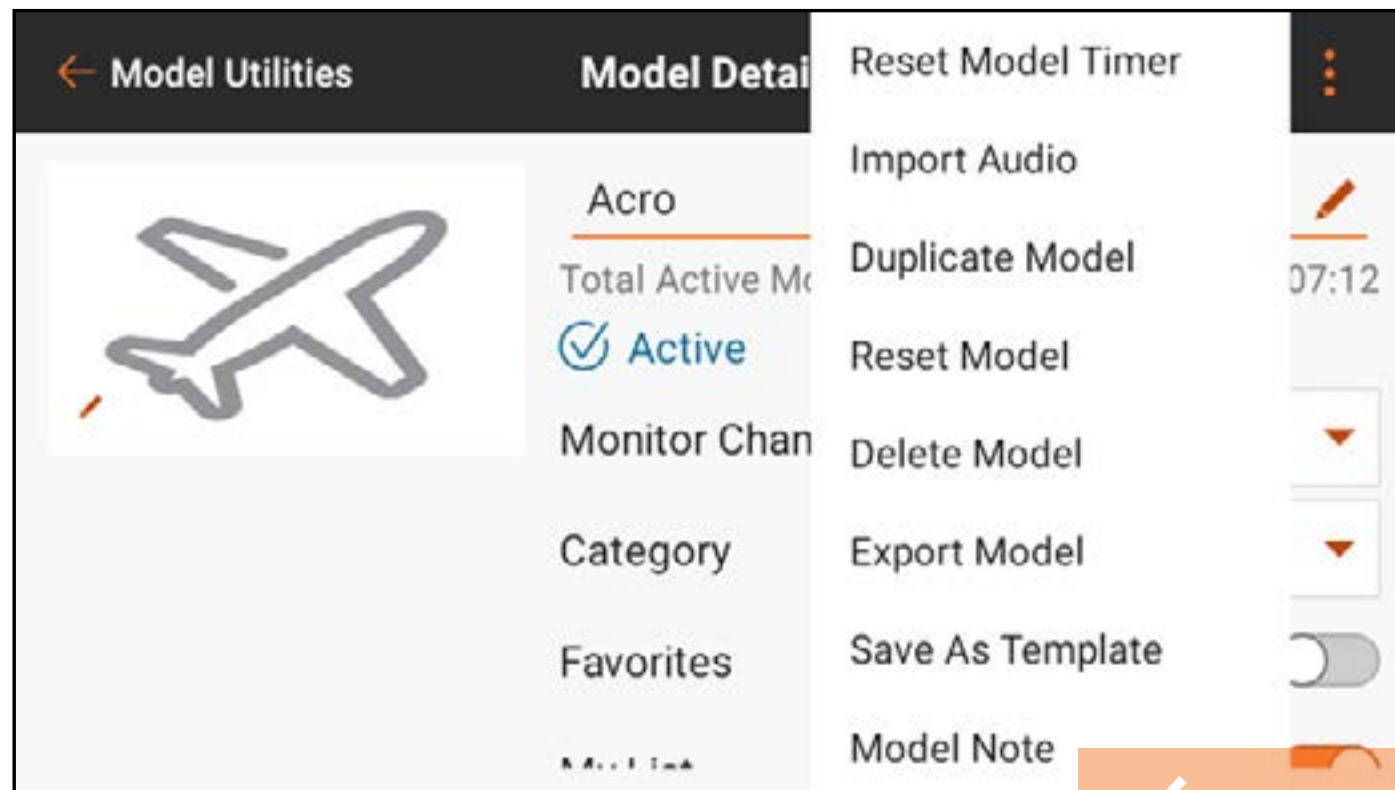

## RESET MODEL TIMER

Touch **Reset Model Timer** to reset the timer for the selected model.

## DUPLICATE MODEL

Touch **Duplicate Model** to make a copy of the selected model as a new model.

## RESET MODEL

Touch **Reset Model** to return all values of the selected model to the default values.

## DELETE MODEL

Touch **Delete Model** to delete the model from the model list.

## IMPORT AUDIO

To import the audio events from another stored model to the active model:

1. From the Model Details screen of the active model, touch the expand icon (⋮).
2. Touch **Import Audio**.
3. Select the model from which to import the audio events.
4. Touch **IMPORT**.
5. Touch **IMPORT** again.

## EXPORT MODEL

To export the selected model file settings for use on a different transmitter:

1. Touch **Export Model** to export the selected model file.
2. The **.ispm** file extension is selected. This file format is compatible with other Android based Spektrum AirWare equipped transmitters. This format includes all settings from the file being copied, except for the model image.
3. Touch **EXPORT**. A list of connectivity options appears.
4. Save the file to a memory card in order to transfer it to another transmitter.

## SAVE AS TEMPLATE

Select **Save As Template** to save the selected model as a default model template, which can be accessed any time a new model is created.

**TIP:** Establish a default for each model type to define switch positions, text to speech features, telemetry configurations, rates and curves, or any features commonly used on a given type of model.

## MODEL NOTE

Use this option to add notes to support the model. This can include setup details, flight logs, fuel mixtures, etc.

To add a model note:

1. Touch and drag up in the expanded Model Details list to scroll to the bottom.
2. Touch **Model Note**.
3. Touch the text field to access the text input screen.
4. Touch **DONE** when the note is complete.
5. Touch the back arrow ( ← ) to exit Model Note.

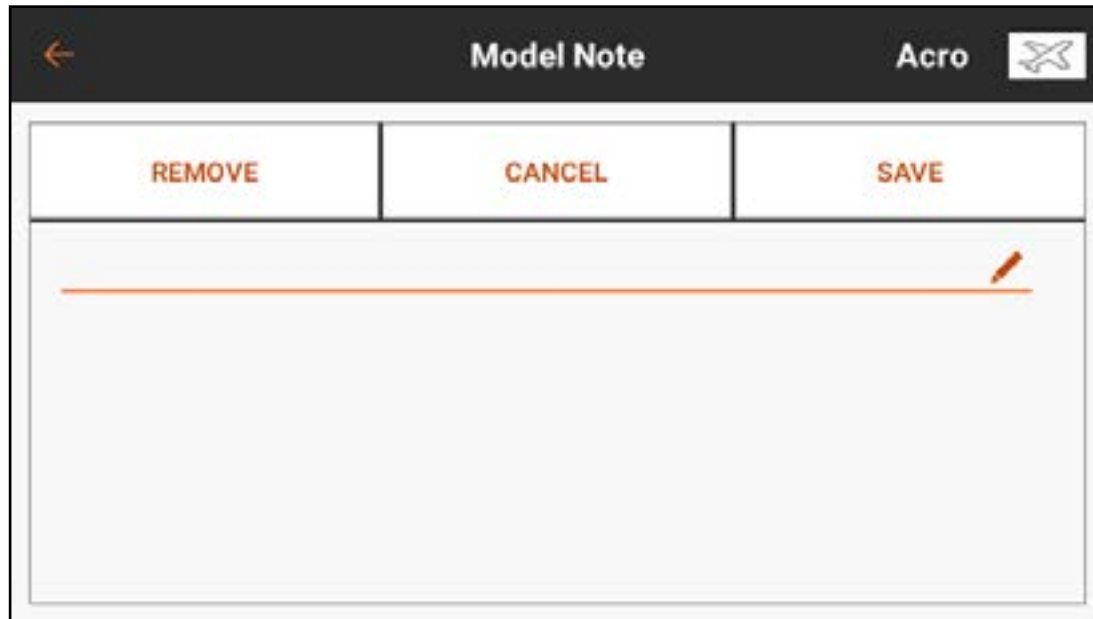

## BINDING

Binding is the process of linking the iX14 to an aircraft receiver. The iX14 is compatible with genuine DSM2<sup>®</sup> and DSMX<sup>®</sup> Spektrum receiver products. The EU version of the iX14 does not support DSM2 receiver products.

Access the Bind menu from the Model Setup menu or access it directly by touching the **BIND** button on the Dashboard screen.

Activate **Telemetry Auto Config** to automatically configure telemetry after a successful bind with a telemetry receiver. See **Auto-Configuring Telemetry At Binding** for more information.

Touch **Alerts** to configure any alerts which occur during binding.



## SPEKTRUM FAILSAFE TYPES

Spektrum receivers use two types of failsafe modes, Smartsafe™ with hold last command and Preset. These are set on the receiver during the binding process.

- **SmartSafe™ failsafe mode** keeps the receiver from powering the throttle channel in the event an aircraft is powered on prior to the transmitter, thus reducing the likelihood of an electric powered model accidentally powering on when no transmitter signal is present. After connection, in the event of a hold, the throttle channel will be moved to the position set during bind. This failsafe mode will hold other control inputs at the last known command until the transmitter/receiver link is re-established. If the throttle control has been mapped to another channel in the transmitter setup, use the Preset failsafe mode.
- **Preset failsafe mode** returns all control commands to the binding presets.

It is important to know how and when to use each of the failsafe modes. Consult the receiver manual for information.



## BINDING AND PROGRAMMING FAILSAFE

Failsafe is configured when the transmitter and receiver go through the binding process. When binding an aircraft, always follow these steps to ensure the failsafe operates as expected in the unlikely event of a loss of radio link:

1. Move the throttle to the low or off position.
2. Set all other controls to the desired failsafe position.
3. Follow the receiver instructions to power the receiver on in bind mode.
4. From the iX14 transmitter Bind menu, touch and hold **BIND** until the transmitter reports it is binding.
5. When the transmitter indicates binding was successful, power off the receiver, according to the receiver instructions.

After the transmitter and receiver are bound, if the radio signal link is ever lost between the transmitter and receiver, the receiver immediately moves the aircraft control surfaces to the failsafe positions or holds position depending on the type of failsafe set during bind.

## TESTING FAILSAFE

 **CAUTION:** Make sure the aircraft is fully restrained on the ground. If the failsafe is not set correctly, the aircraft might advance to mid or full throttle. Always remove propellers or disengage motors from drive systems when testing failsafe on electric power systems.

**NOTICE:** Failsafe features vary according to receiver. Always consult the receiver instruction manual for failsafe features. Before flight, ALWAYS confirm failsafe functions as expected.

The aircraft must be configured and binding complete prior to testing the failsafe settings.

To test the function of the failsafe settings:

1. Power on the transmitter and receiver and confirm the controls function properly.
2. Power off the RF signal on the transmitter by double clicking the power button, switching off **RF** and touch and hold **OK**. The throttle and control surfaces should immediately move to the expected failsafe positions or hold position depending on the failsafe type set during bind. Throttle should always be set to return to low throttle.
3. Restore the RF signal by double pressing the power button and selecting RF on and touch and hold OK.

# AUTO SWITCH SELECT

Switches, sliders, trims and the rotary knob on the iX14 are all assignable. Switches may be assigned for various functions, for example, assigning a dual rate switch or activating throttle cut (shown below).

To assign a switch to a function:

1. Touch the “Switch” selection box.

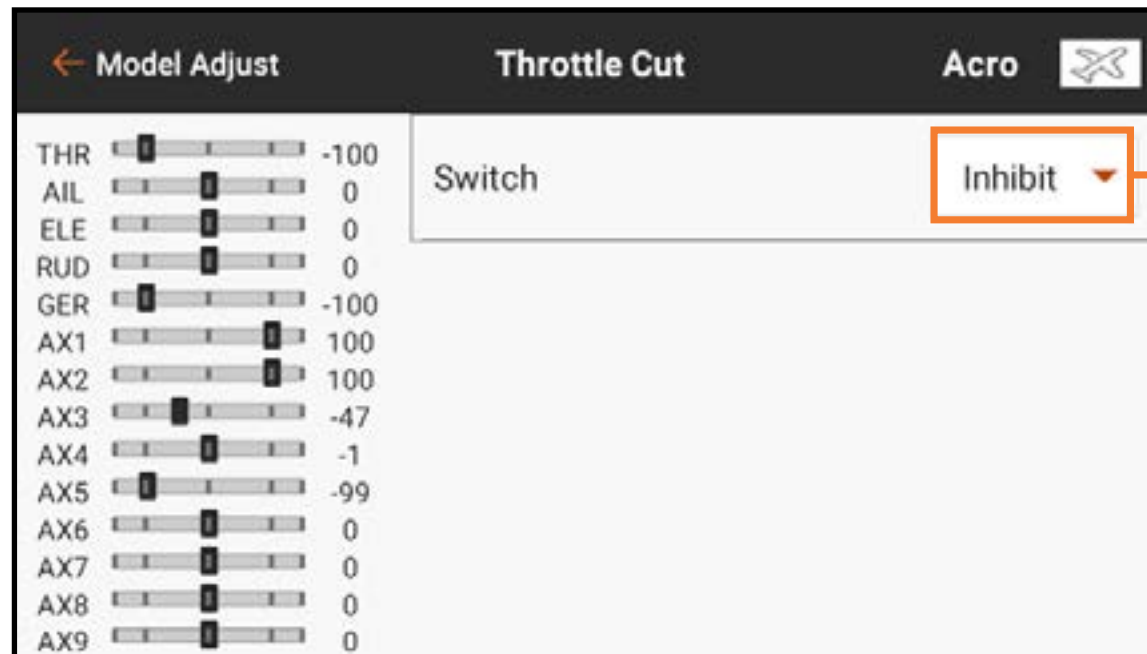

Switch selection

2. Select the desired switch from the popup menu. A quicker alternative to selecting the switch from the popup menu is to toggle the actual desired switch while the popup menu is active. The switch will automatically be assigned to the selected function.

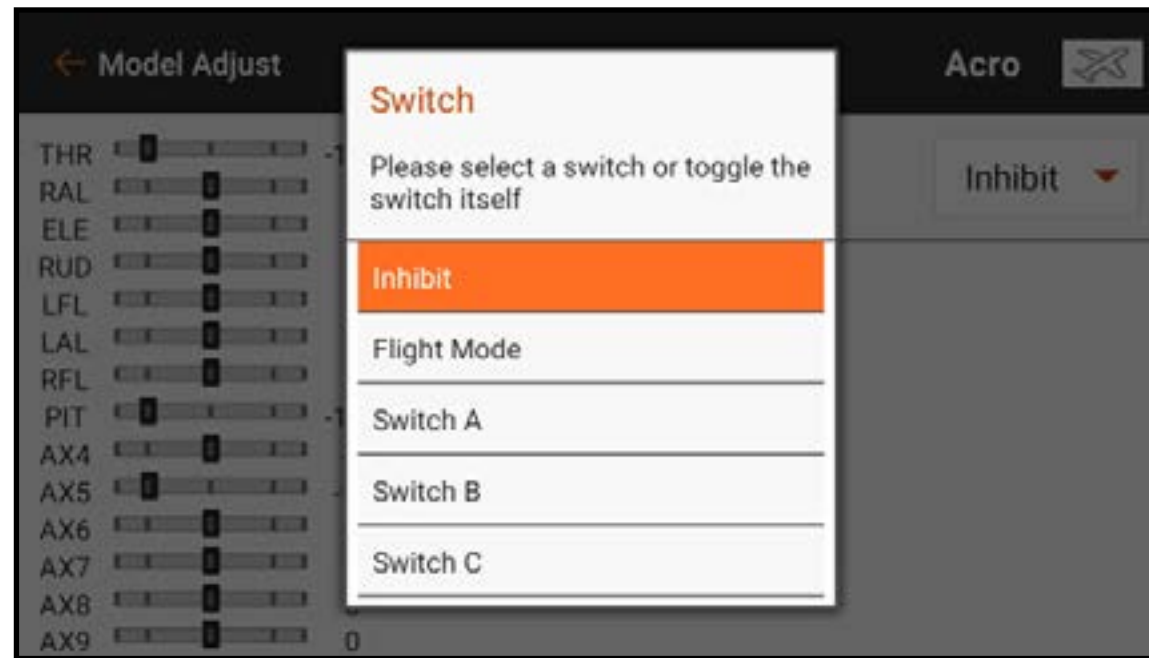

# ACTIVE BOXES

Many of the iX14 menus include Active Boxes. These boxes represent switch positions when the value or condition being shown will be active or inactive. The active box appears grey by default, indicating the curve or condition is active at this switch position. The switch position directly corresponds to the curve or condition. At switch position 0, curve 0 is active. At switch position 1, curve 1 is active and so on.



Active Boxes

## ACTIVE BOX CUSTOM SETUP

Select Custom Setup to customize the switch position to active curve setup.

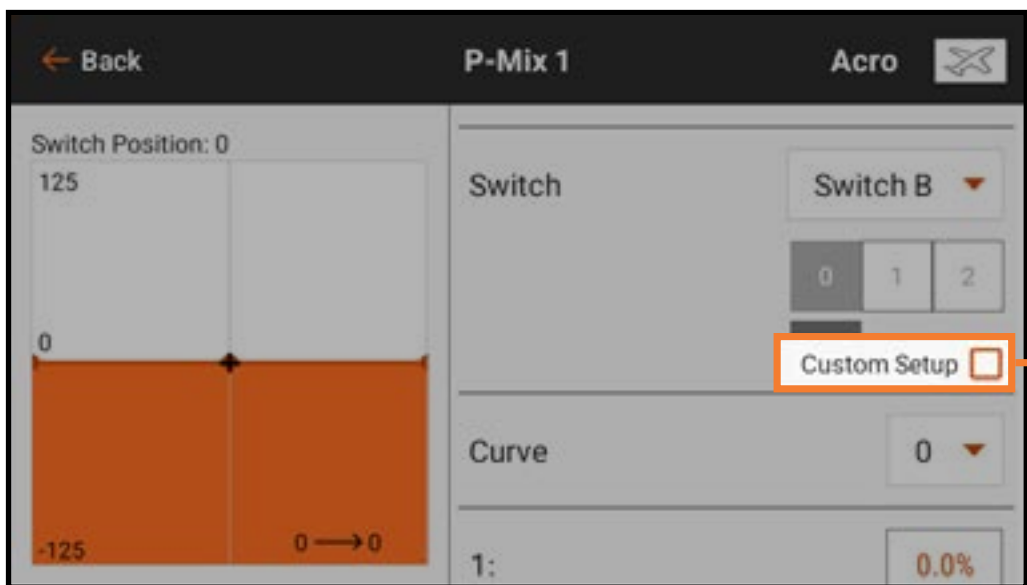

Custom Setup

With Custom Setup selected, the active box for each curve is shown in orange. Custom Setup allows you to select which switch position to use for each curve/condition. Select the curve then touch the desired active button(s) to assign the switch positions to be used for the selected curve. Any of the curves can be assigned to all or none of the switch positions, but only one curve can be assigned to each switch position.

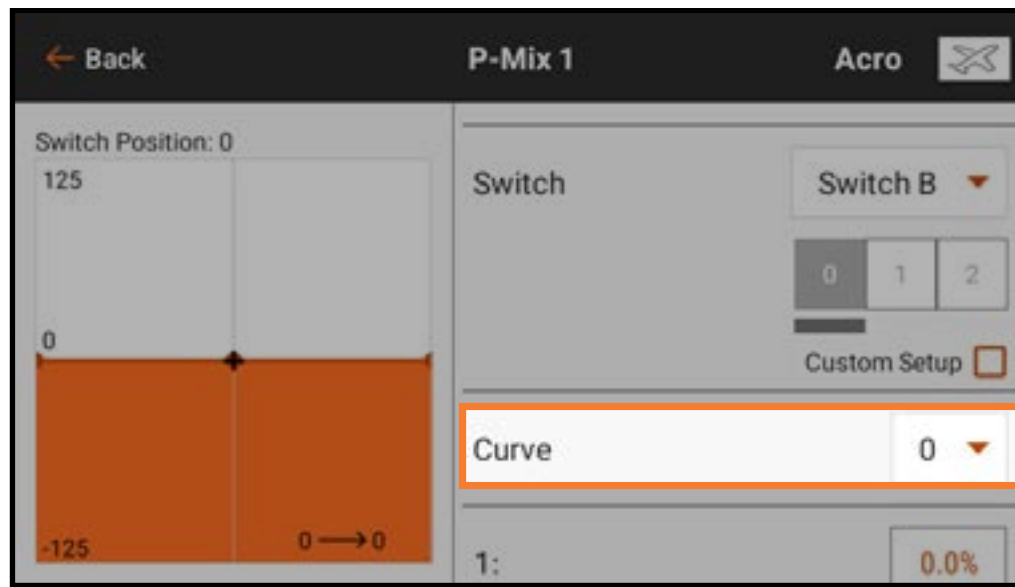

Curve

Select a curve to change the curve that is displayed on the screen. Selecting the curve shows the active switch position for that curve. This may be changed by selecting or deselecting the active switch box.

Change the shape of the curve by increasing or decreasing the percent values of each point along the curve, or add and delete curve points, as described in the Mixing section.

**IMPORTANT:** Turning Custom Setup off will reset the curve switch assignments back to the default settings.



# MY LIST

My List allows the user to create a list of shortcuts to quickly navigate to the most used functions for each model entry.

To create a My List shortcut list:

1. Go to the **Model Details** menu for the model.

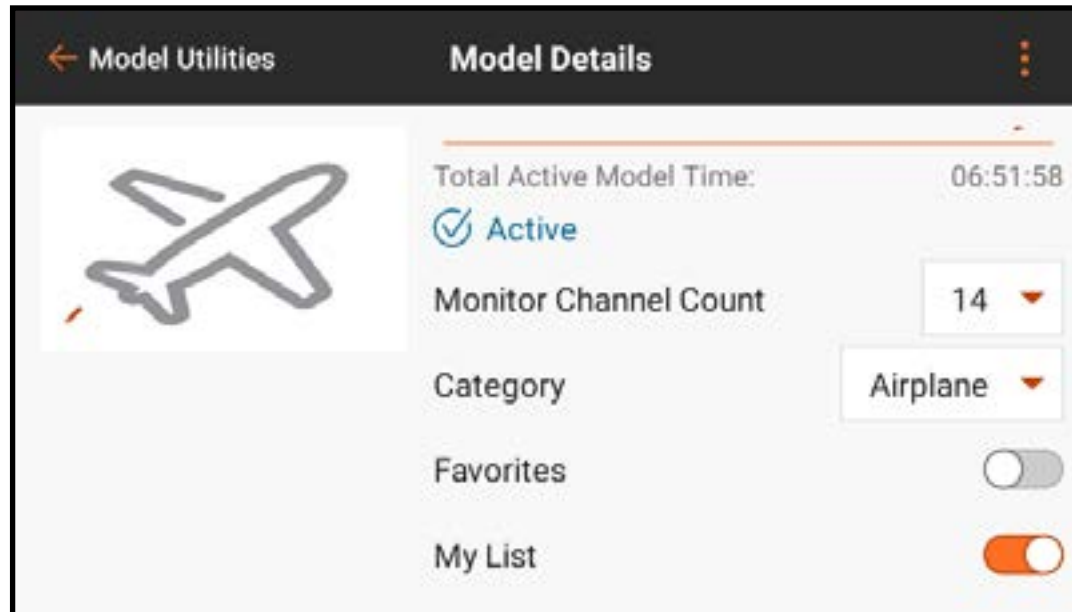

2. Scroll to the bottom of the menu and activate the **My List** option.

3. Return to the main dashboard screen.
4. Touch the **My List** tab on the main screen.

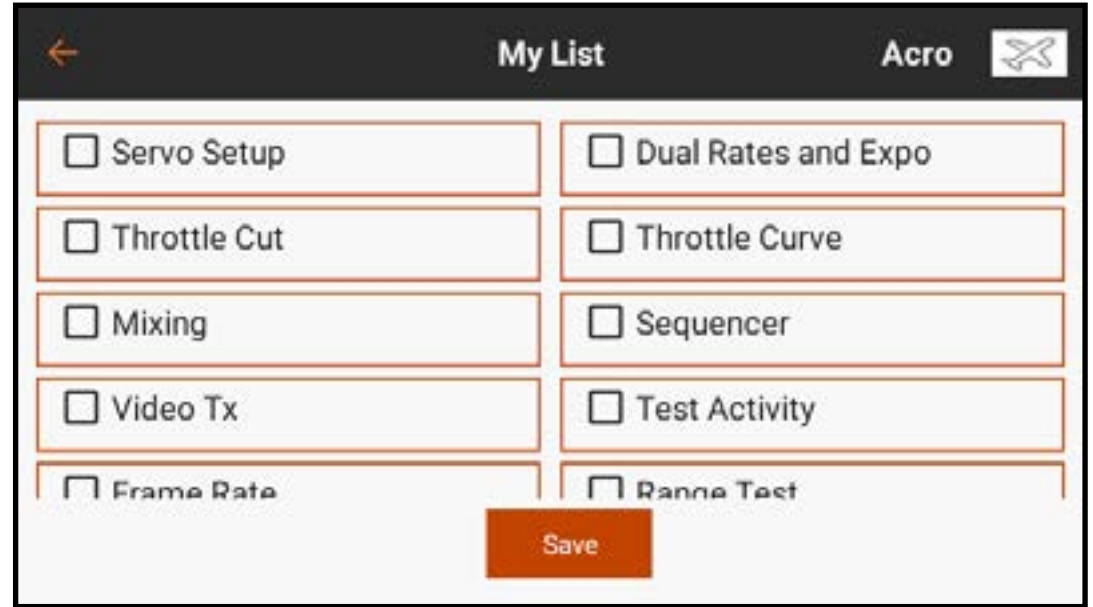
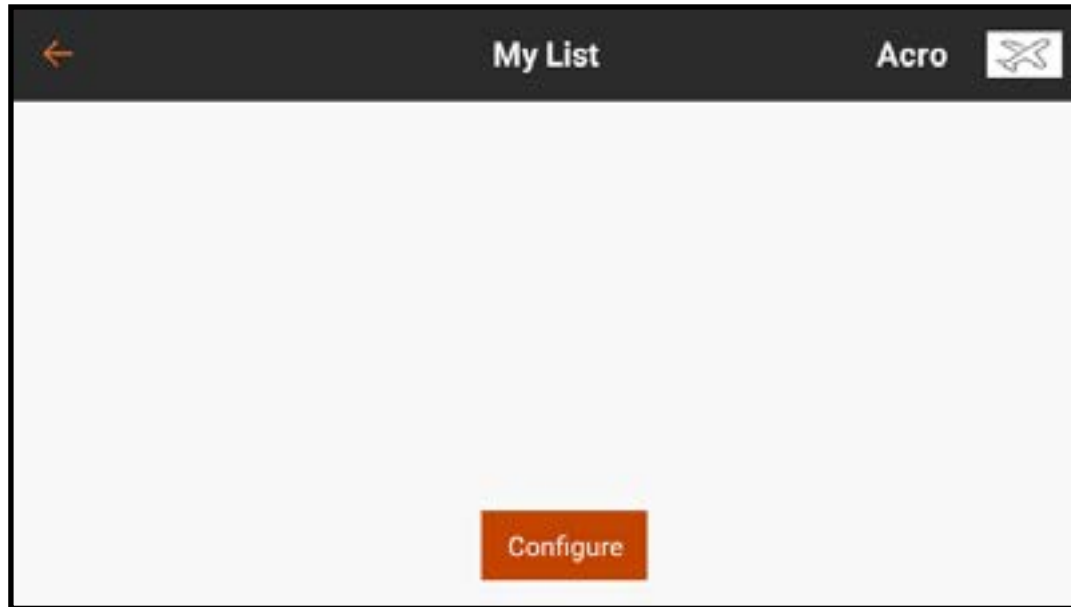

- Touch the **Configure** button and select which functions to add to the **My List**. The functions will have a check mark next to the name when selected.
5. Touch the **Save** button to save the list.

The selected functions are now directly available in the **My List** screen.

**TIP:** The functions in the **My List** tab menu can be re-ordered to suit your needs.

1. With the **My List** menu open, touch and hold the menu item you wish to move.
2. The transmitter vibrates to indicate the selection.
3. Drag the menu item to the desired location.

The **My List** tab menu is configurable for each model and may be turned on or off from the **Model Details** menu.

# MODEL ADJUST

The Model Adjust menu contains features and adjustments that are used to finalize the settings for a model configuration. Options in the Model Adjust menu will vary depending on the model type selected during initial model configuration and the aircraft type selected in the Model Setup menu.

The Model Adjust menu features common across model types include:

- Servo Setup
- Mixing
- Dual Rates and Expo
- Forward Programming
- Sequencer
- Video TX

Model Adjust menu options specific to certain model types include, but are not limited to:

### **Airplane Type**

- Differential
- Flap System

### **Helicopter Type**

- Pitch Curve
- Gyros
- Governor
- Tail Curve

### **Sailplane Type**

- Camber Presets
- Camber System
- Pre-Configured Mixes

### **Multirotor Type**

- Motor Cut
- Motor Curve

# SERVO SETUP

From the Model Adjust menu, touch **Servo Setup**.

The following setup sub menus are available:

- Reverse
- Travel
- Sub Trim
- Speed
- Absolute Travel
- Balance

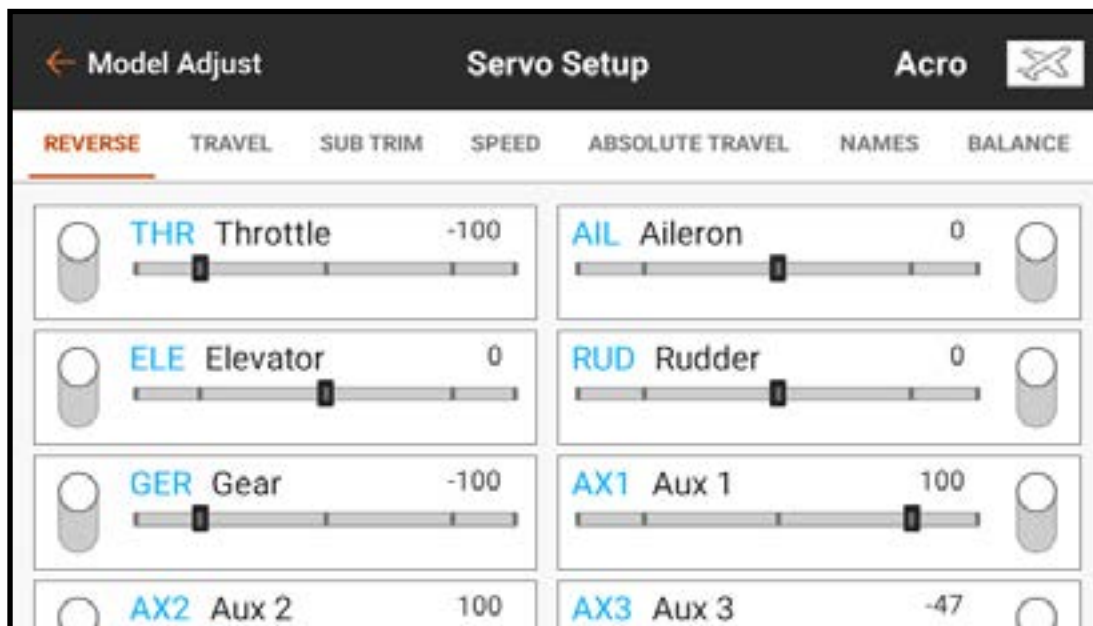

Touch the desired function in the ribbon at the top of the screen to bring up the corresponding setup sub menu.

Touch and drag on any of the sub menus to scroll through the channel lists.

The Model Adjust menu can be accessed at any time from the Servo Setup sub menus by touching the back arrow ( ← ).

Touch and hold the back arrow ( ← ) to return to the dashboard.



**CAUTION:** After adjusting the servo setup, always rebind the transmitter and receiver to set the failsafe position.

## REVERSE

Use the Reverse menu to reverse the travel direction of any channel. For example, if the elevator moves up and it should move down, reverse the elevator channel travel direction.

To reverse a channel travel direction:

1. Select **Reverse** in the Servo Setup menu ribbon.
2. Touch the button next to the channel you wish to reverse.

If the throttle channel is reversed, a confirmation screen appears. Select YES to reverse the channel. A second screen appears, reminding to re-bind the transmitter to the receiver, at low throttle, to re-set the throttle failsafe.



**CAUTION:** Always rebind the transmitter and receiver after reversing the throttle channel. Failure to do so will result in the throttle moving to full throttle if failsafe activates.

Always perform a control test after making adjustments to confirm the model responds properly.



# TRAVEL

The Travel menu sets the travel or endpoints of the servo arm movement.

The screenshot shows the 'Servo Setup' menu with the 'TRAVEL' tab selected. The menu is titled 'Model Adjust' and 'Acro'. The 'TRAVEL' tab is highlighted with an orange underline. The menu displays settings for four servos: THR (Throttle), AIL (Aileron), ELE (Elevator), and RUD (Rudder). Each servo has a slider and two endpoint values.

Servo	Label	Value	Low	High
THR	Throttle	-100	Low -100	High 100
AIL	Aileron	0	Right -100	Left 100
ELE	Elevator	0	Up -100	Down 100
RUD	Rudder	0	Right -100	Left 100

To adjust travel values:

1. Touch **TRAVEL** in the ribbon at the top of the Servo Setup menu.
2. Select the high or low side of the channel.
3. Touch the lock icon (  ) to adjust both directions at the same time, if desired, or adjust the Low and High values independently.
4. Make adjustments by sliding the highlighted circle, touching the **+** or **-** buttons.
5. Touch **OK** to exit back to the main Travel menu.

**IMPORTANT:** ALT, ROL, PIT and YAW replace THR, AIL, ELE and RUD labels respectively in multicopter to more closely reflect the flight axis of multicopter aircraft.



# SUB TRIM

The Sub Trim menu adjusts the servo travel center point.



To adjust sub trim values:

1. Touch **SUB TRIM** in the ribbon at the top of the Servo Setup menu.
2. Touch the number to the right of the desired channel to open the channel sub trim menu. Changes can be made by sliding the highlighted circle or touching the **+** or **-** buttons.

# SPEED

The Speed menu slows the response time on any channel, such as landing gear or flaps.

The screenshot shows the 'Servo Setup' menu with the 'SPEED' tab selected. The menu is titled 'Model Adjust' and 'Acro'. The 'SPEED' tab is highlighted with an orange underline. Below the tabs, there are four rows of servo settings:

Servo	Value	Mode 1	Mode 2
THR Throttle	-100	Normal	Normal
AIL Aileron	0	Normal	Normal
ELE Elevator	0	Normal	Normal
RUD Rudder	0	Normal	Normal

To adjust speed values:

1. Touch **SPEED** in the ribbon at the top of the Servo Setup menu.
2. Touch either the right or left side value of the desired channel to open the channel Speed menu.
3. Slow the channel response by sliding the highlighted circle or using the **+** or **-** buttons to change the time value. Each side of the servo travel has independent speed adjustments.

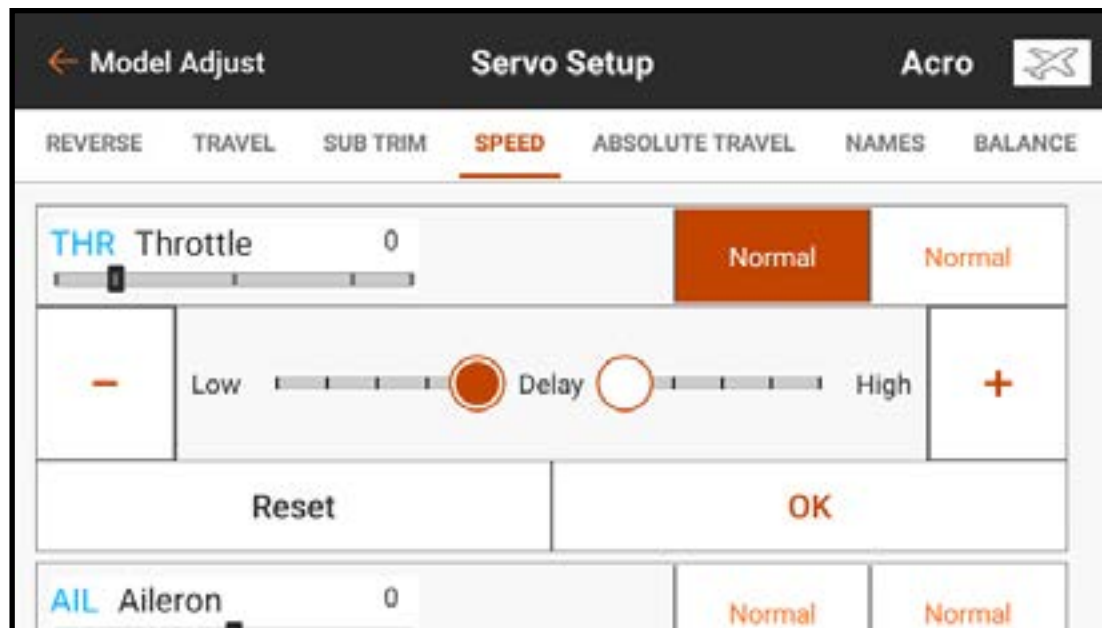

# ABSOLUTE TRAVEL

The Absolute Travel menu limits the amount of travel on a channel, taking into account all combinations of settings: travel, trim, rates, etc. The iX14 will not drive the output past the absolute travel limit. Adjust the absolute travel value to prevent servos from binding or over driving a control surface

The screenshot shows the 'Servo Setup' menu with the 'ABSOLUTE TRAVEL' tab selected. The menu is titled 'Model Adjust' and 'Acro'. The tabs are REVERSE, TRAVEL, SUB TRIM, SPEED, ABSOLUTE TRAVEL, NAMES, and BALANCE. The 'ABSOLUTE TRAVEL' tab is highlighted with a red underline. The servos are listed in a table:

Servo	Trim	Low/Right	High/Left
THR Throttle	-100	Low 1	High 4096
AIL Aileron	0	Right 1	Left 4096
ELE Elevator	0	Up 1	Down 4096
RUD Rudder	0	Right 1	Left 4096

To adjust the absolute travel limit:

1. Touch **ABSOLUTE TRAVEL** in the ribbon at the top of the Servo Setup menu.
2. Touch the low or high values to adjust the limit value in the desired channel. The low point can be adjusted from 1 to 2048, and the high point can be adjusted from 2049 to 4096. Adjust the values independently or touch the lock icon (🔒) to adjust both values together.
3. Touch **OK** to save the entered values and exit back to the Absolute Travel sub menu.

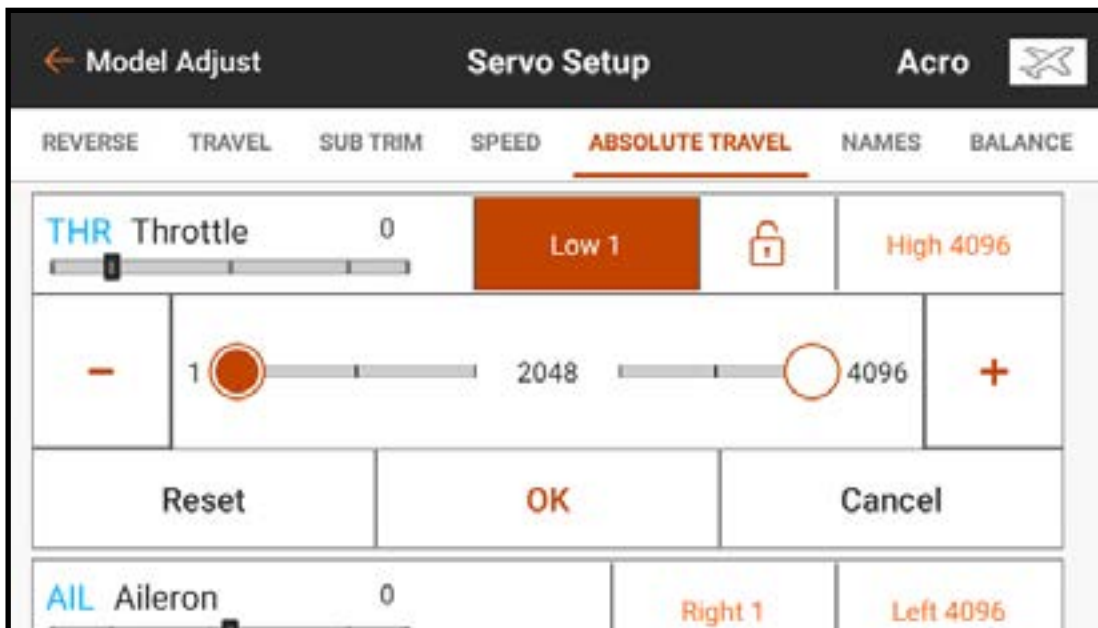

## BALANCE

Balance is an adjustable curve on all channels to fine-tune the servo position at up to seven points along the curve.

Use Balance to:

- Reduce the effects of round servo horns so movement is more linear.
- Prevent binding when multiple servos are used on a single control surface.
- Match throttle response on twin engine aircraft.
- Ensure the swashplate on a helicopter remains level throughout the range of travel.

Balance is not intended to be used to set travel, trim and reversing changes, but to fine-tune the range of travel after those settings have been defined.



To balance the servo output on a given channel:

1. Touch **BALANCE** in the ribbon at the top of the Servo Setup menu.
2. Select the desired channel to adjust.
3. Touch one of the seven values displayed below the curve. The number value is highlighted along with the corresponding point on the curve.



Selected channel  
Curve  
Point values

4. Adjust the value using the **+** or **-** buttons. The values for each point range from -74 to 74. Touch **CLEAR ALL** to reset all values to 0.
5. Touch the back arrow ( **←** ) or select another option in the Servo Setup ribbon to exit Balance.

The Balance menu does not scale with travel or trim and the points are at fixed locations on the range of travel.

# DUAL RATES AND EXPO

Dual Rates and Exponentials are available on the aileron, elevator and rudder channels.

← Model Adjust      Dual Rates and Exponentials      Acro 

Switch Position: 1

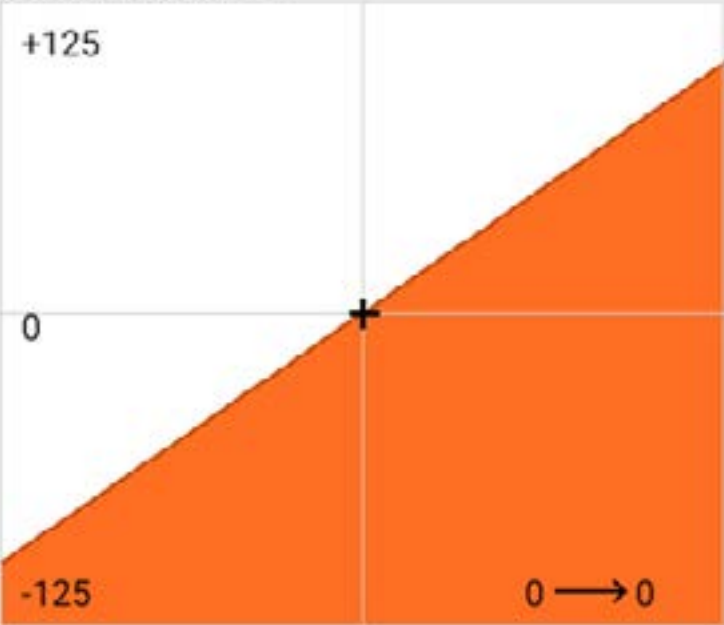

Channel: Aileron ▾

Dual Rates: 100%    100%

Expo: 0%    0%

Switch: On ▾

**Dual rates** are commonly used to set up models for different flight performance. Dual rates cannot increase surface travel. They only reduce travel. One rate setting for a control surface normally allows for full travel. Other rate settings for that surface reduce the travel available. For example, on an aerobatic model with large control surfaces, high rates are used to deliver full control surface travel, which is useful for extreme aerobatics. Low rates are used to reduce control travel, so control response is reasonable for normal flight and landings.

**Exponential** affects control sensitivity around center but has no effect on overall travel. Positive exponential decreases the sensitivity around the center of gimbal movement. Use a small amount of positive expo to compensate for the rotation of the servo horn, achieving a more linear surface movement. Adding more expo softens the control response toward center stick, making smoother, more precise flight easier.

Program each control (rudder, elevator and aileron) individually.

To program dual rates and expo:

1. From the Model Adjust menu, touch **Dual Rates and Expo** to open the scrollable menu.
2. Touch the **Channel** button to select the desired control to adjust.
3. Scroll to the bottom of the menu and touch the **Switch** button to select the desired switch. Select **On** for the switch selection to define only one rate and expo setting for the control selected.

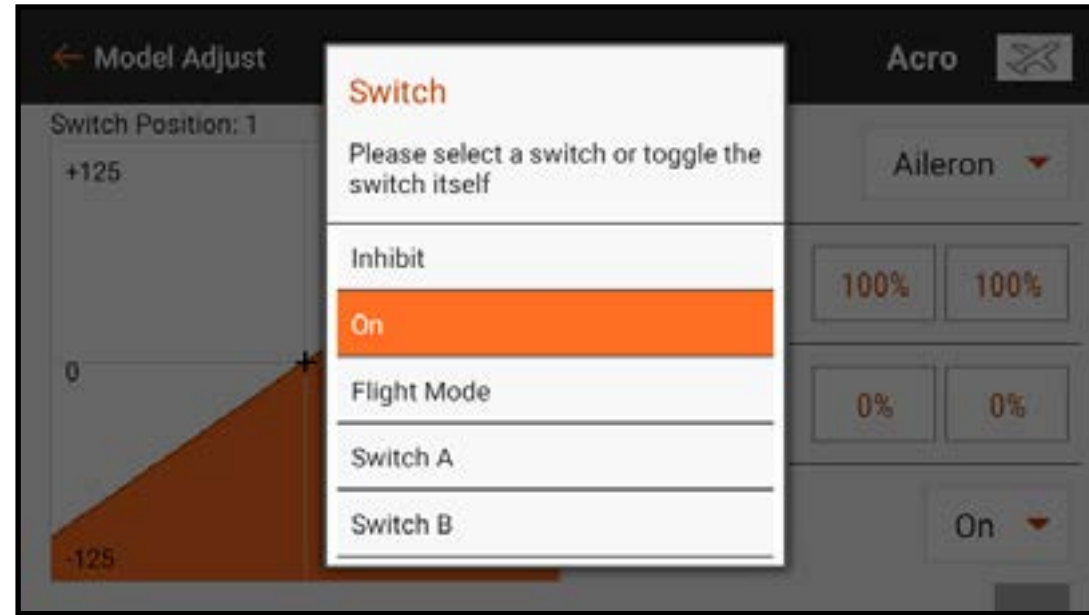

4. Touch the **Dual Rates** values to access the value sliders.
5. Adjust the travel rates for each switch position. Each rate number affects one side of the servo travel from the center. 100% results in full travel. A 50% rate results in 50% of full travel. Touch the lock icon (🔒) to adjust both values together or separately.
6. Touch **OK** to save the values.

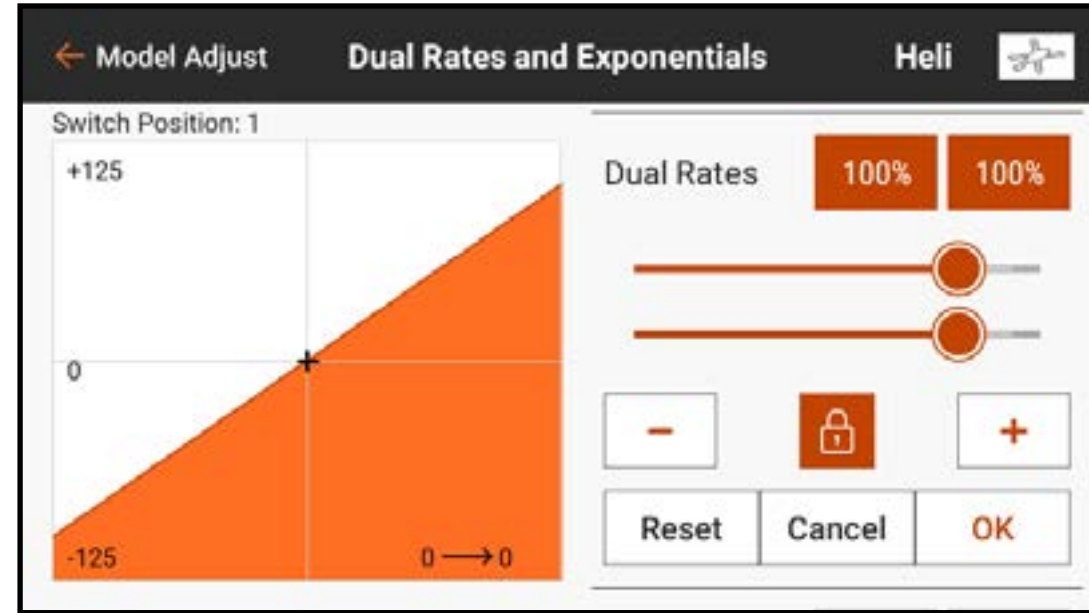

- Adjust the expo value for each switch position. Touch the lock icon (🔒) to adjust both values together or separately. Adding positive expo makes the control less sensitive around the center. Adding negative expo makes the control more sensitive around the center.
- Touch **OK** to save the values.

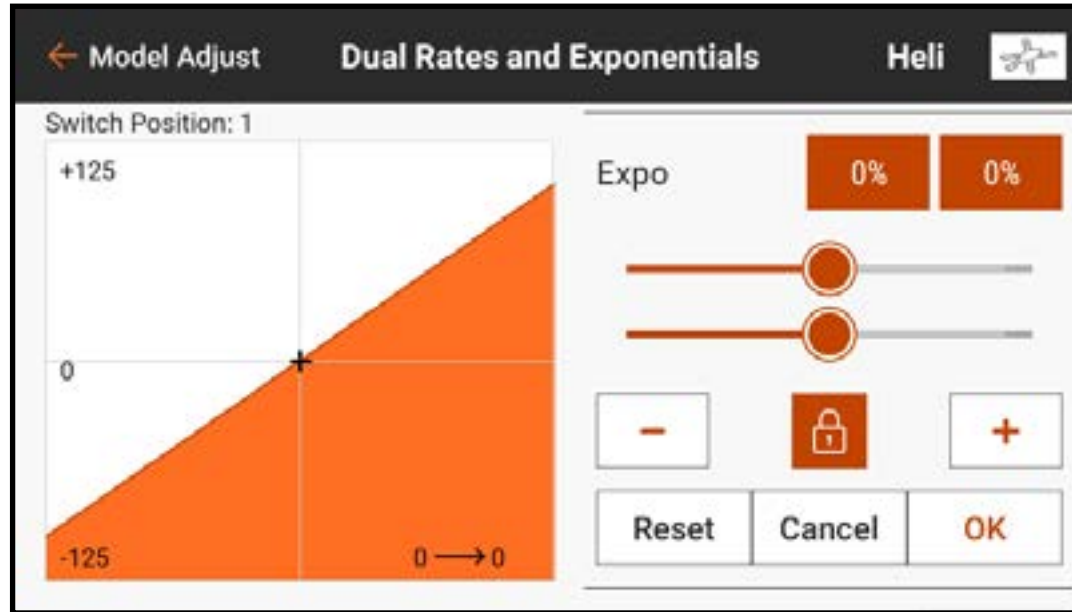

# THROTTLE CUT

Program the Throttle Cut function to ensure the motor is off when the throttle cut is activated.

The screenshot displays the 'Throttle Cut' configuration screen. On the left, there is a list of servos with their corresponding sliders and values:

Servo	Value
THR	-100
AIL	0
ELE	0
RUD	0
GER	-100
AX1	100
AX2	100
AX3	-47
AX4	-1
AX5	-99
AX6	0
AX7	0
AX8	0
AX9	0

On the right side, there is a 'Switch' configuration area. It includes a dropdown menu currently set to 'Inhibit'.

To program Throttle Cut:

1. From the Model Adjust menu, touch **Throttle Cut**.

2. Assign a switch to throttle cut either by choosing the switch from the popup menu or by using auto switch selection. The numbered boxes give a visual representation of which switch position throttle cut will activate.

The shaded box indicates throttle cut is active. These boxes can be changed to on or off by touching them once. The gray bar under the boxes indicates the current position of the active switch.

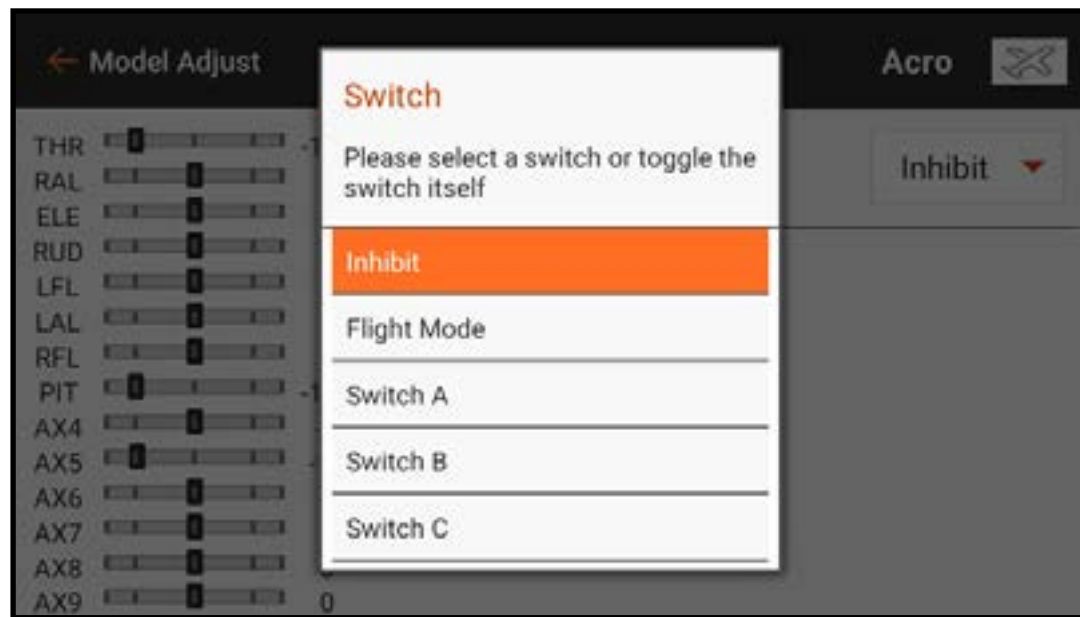

**IMPORTANT:** Always have at least one switch position “on” and at least one “off” for the throttle cut to function as intended.





3. Assign the throttle cut position. The default setting is -100.
4. Assign the Delay value. The default time is 0.00s to give an immediate throttle cutoff when activated.
5. Check the functionality of the throttle cut by watching the throttle channel in the monitor on the left side of the screen.

## THROTTLE CURVE

Creating and fine-tuning a throttle curve is one of the last steps in preparing a new aircraft for flight. Ensure all other controls are set up and functioning correctly and the model is safely secured prior to starting the engine.

Some models may exhibit rapid RPM change from low to half throttle input and very little change in RPM from half to full throttle input. Throttle Curve is used to achieve a linear throttle response to control input over the full range of throttle stick movement.

To create a throttle curve:

1. From the Model Adjust menu, touch **Throttle Curve**.
2. Select a switch or **On** to enable curve adjustments. Multiple curves can be configured on a switch to provide multiple throttle curve options. Select **On** to select only one curve.  
On the graph, the horizontal axis represents the movement of the throttle stick. The vertical axis represents the throttle output. A black **+** on the graph indicates the current throttle stick position.

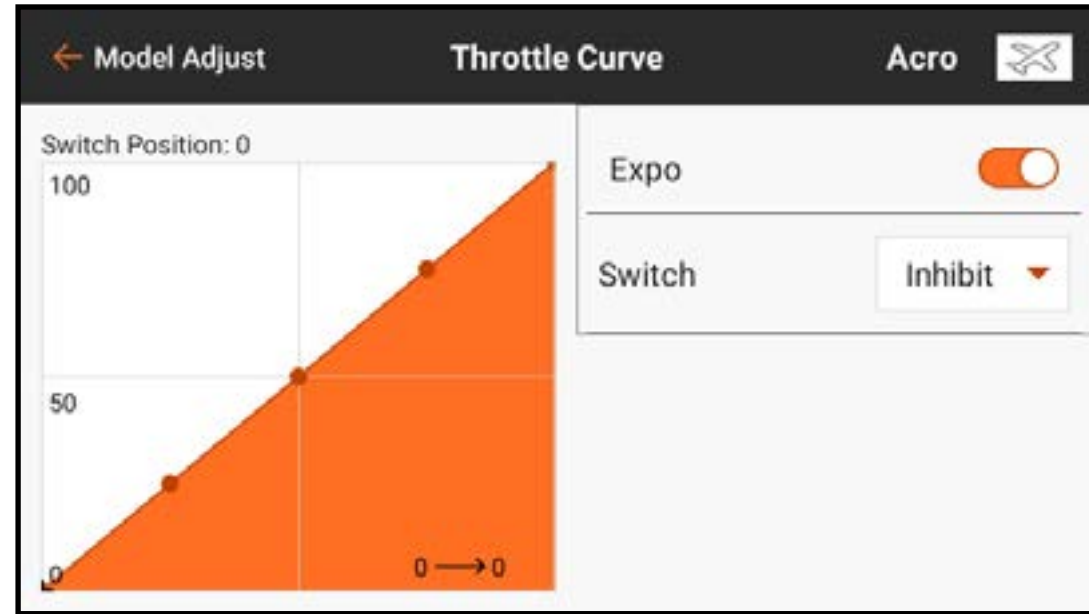

3. Touch and drag up the right side of the screen to view the value of each point on the curve. The point values do not appear until the curve is enabled in Step 2.

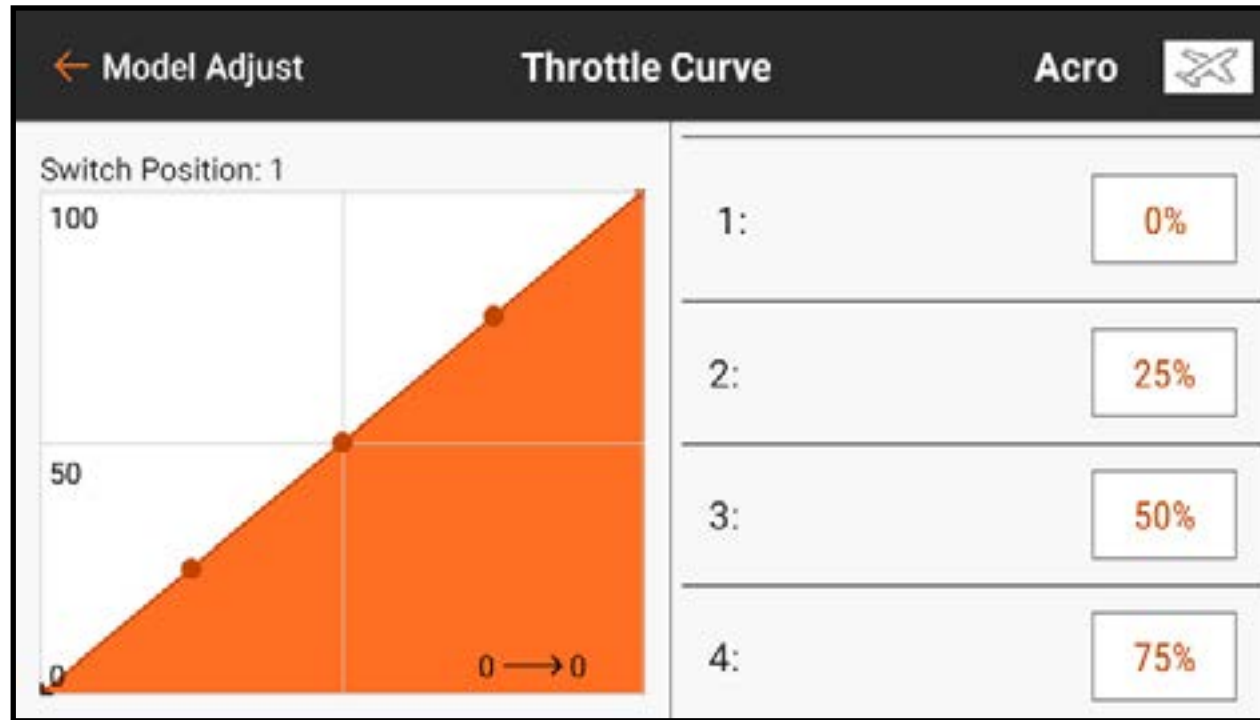

4. Move the throttle stick up and down. A gray bar appears to the left of the point value associated with the throttle stick position.

5. Touch the point value box for any point that requires adjustment. A slider and **+** and **-** appear to adjust the point position up or down on the graph.

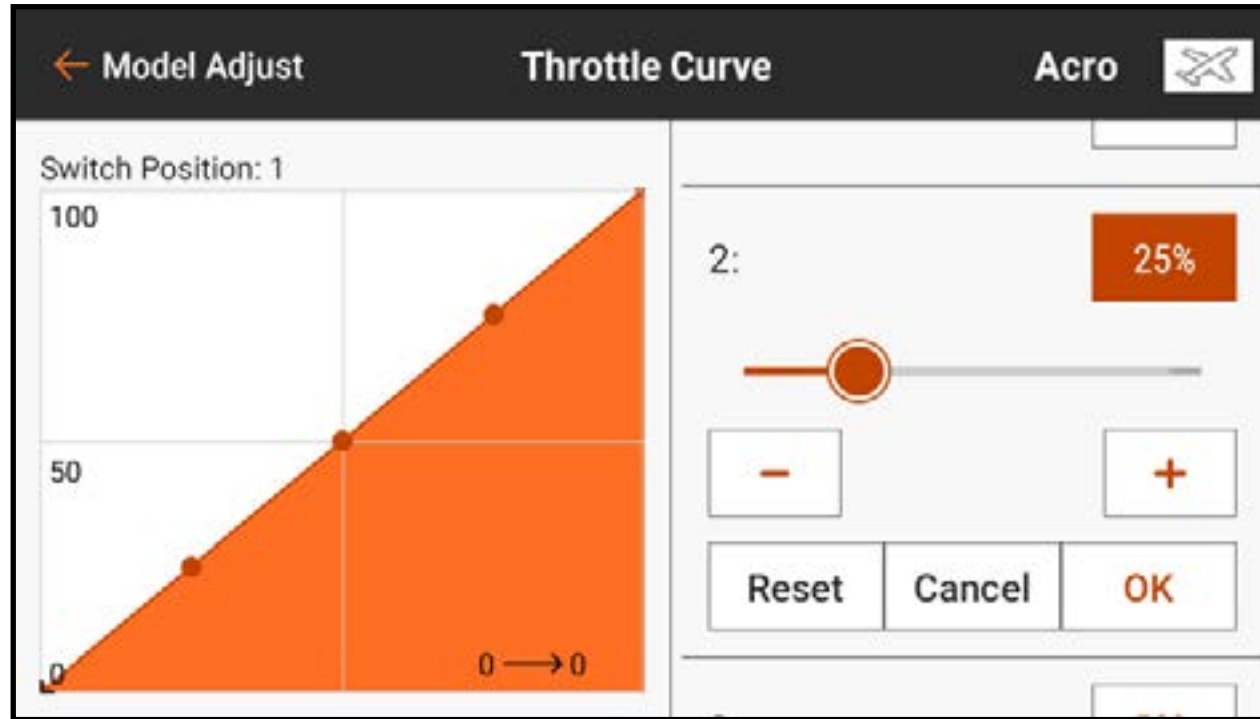

6. Touch **OK** when the selected curve point is in the desired position.

7. Switch **Expo** on to smooth the curve between points.

## ADDING AND DELETING CURVE POINTS

A maximum of 7 points, at a minimum of 10% apart, are available on the throttle curve.

To add a curve point:

1. Move the throttle stick to the desired position for the new point.
2. Touch and drag on the right side of the screen to scroll to the bottom of the curve point list.
3. Touch and hold the **Add Pt** button until it changes to orange, then release.

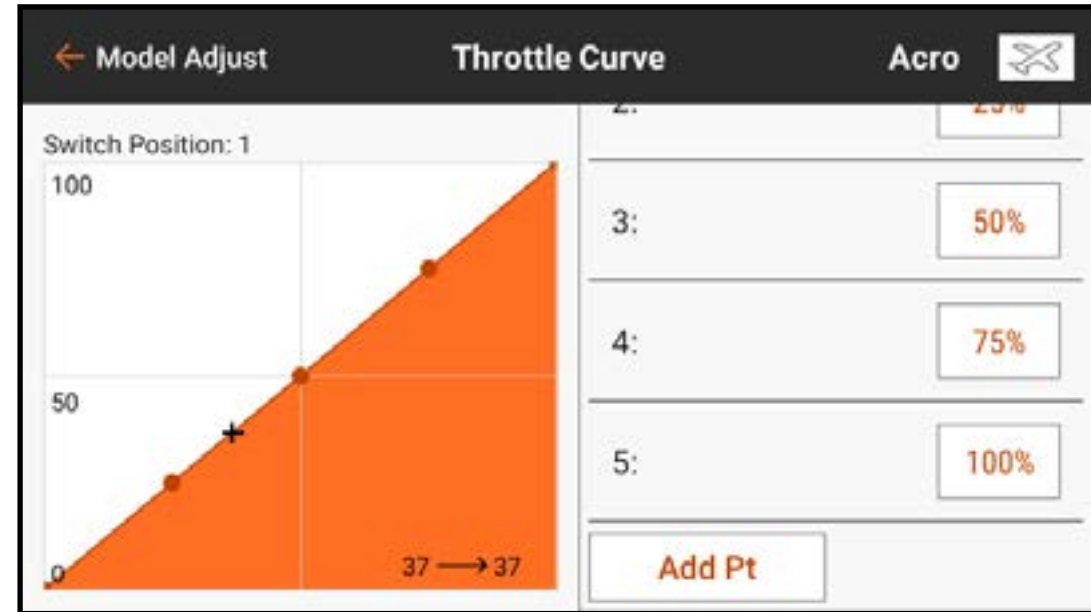

To delete a curve point:

1. Move the throttle stick to the position of the point to be deleted.
2. Touch and drag on the right side of the screen to scroll to the bottom of the curve point list.
3. Touch and hold the **Add Pt** button until it changes to orange, then release.

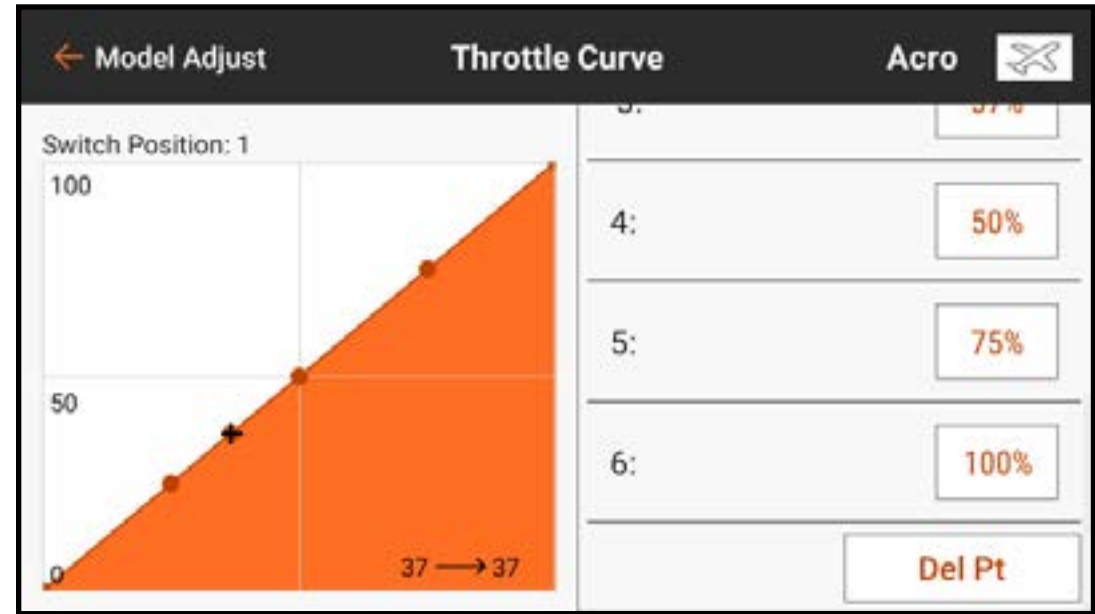

## HELI, SAIL AND MULTIROTOR THROTTLE CURVE

In Heli Model Type, throttle curves are tied to the various flight modes. Each flight mode has a different throttle curve which must be set up individually.

Throttle curves are called Motor Curves in Sailplane and Multirotor menus. When the Sailplane Model Type, the motor must be assigned a stick or switch for the Motor Curve menu to appear in Model Adjust.



# THROTTLE HOLD

Throttle Hold must be enabled in Model Setup, Flight Mode Setup by selecting a **Hold Switch**.

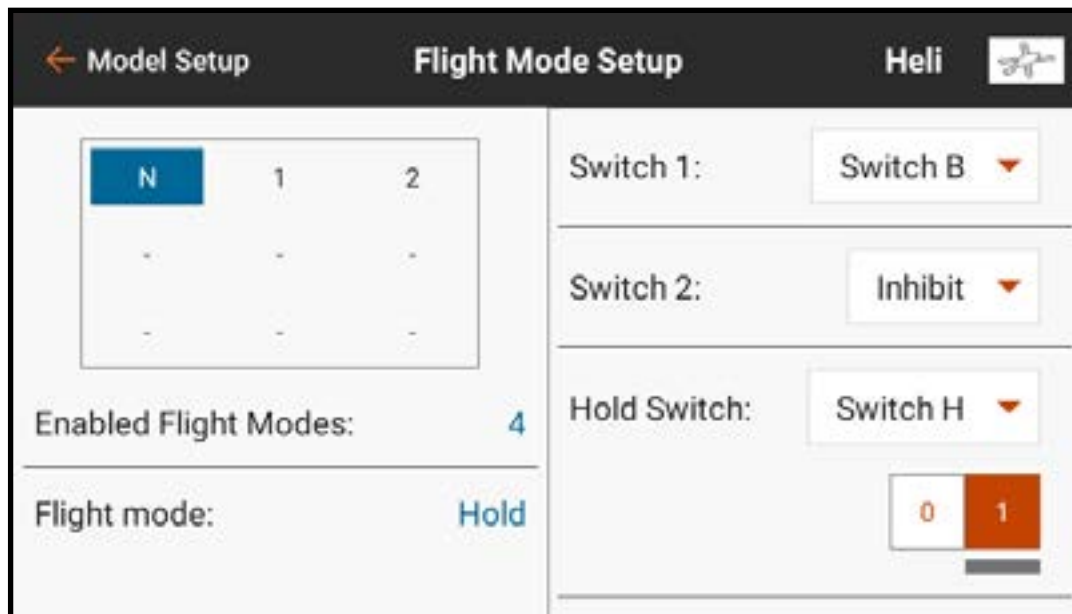

Once enabled, Hold appears as one of the flight mode options in the Throttle Curve and Pitch Curve menus. The throttle hold flight mode has two main components, the throttle curve and the pitch curve. Setting the Hold throttle curve at a constant value (flat curve), establishes the idle or power off setting. The pitch curve is a dedicated curve set up to allow for autorotations.

The throttle hold should be programmed for zero throttle for electric helicopters, and engine idle speed for fuel powered models. Throttle hold serves three purposes for heli pilots:

1. Model helicopters can be extremely dangerous if the throttle is inadvertently bumped. Throttle hold is used when the helicopter is being prepared for flight. The general rule is never exit throttle hold until the model is ready for flight and the pilot is at a safe distance.
2. Throttle Hold is used for intentional autorotations where the pilot can practice the maneuver of landing the helicopter without power, using the potential energy of the model.
3. Throttle Hold is a safeguard when things go wrong.



**TIP:** Always fly with a finger on the throttle hold switch and be prepared to activate it at any moment in case of an out of control model or unexpected obstacle in the flight path. Activating throttle hold immediately eliminates power to the rotor blades. Always activate throttle hold prior to a crash to help limit damage to the aircraft components.

## PRACTICAL THROTTLE CURVE EXAMPLE

The following is a step-by-step example of creating a throttle curve for a gas-powered airplane. Use similar steps to set up any aircraft.

1. Start the engine.
2. Using a tachometer, find the RPM range. Subtract the idle RPM from the full speed RPM to get the RPM range.
3. Divide the RPM range in half. Add the half RPM value to the idle RPM for the half RPM speed.
4. Find the throttle value that delivers the half RPM speed.
5. Adjust the center point on the throttle curve to the half RPM value.

Every point along the curve can be adjusted similarly to find the exact throttle value for each point in the range. Ensure the curve transitions smoothly through the center point to deliver a smooth response through the RPM range.

# VIDEO TX

Spektrum control signals include a special command system to manage frequencies and power output on video transmitters. Compatible video transmitters can be managed from this menu by connecting a signal wire from the aircraft receiver to the video transmitter. See the video transmitter manual for more information.

The screenshot shows a flight controller interface with a dark header bar. On the left, there is a back arrow and the text "Model Adjust". In the center, "VTX" is displayed. On the right, the word "Acro" is shown next to a small airplane icon. The main area is divided into two columns of settings. The left column has four rows: "Band:" with a dropdown menu showing "A", "Channel:" with a dropdown menu showing "CH 1 - 5865MHz", "Power:" with a dropdown menu showing "15-25mW", and "Flight mode:" with a dropdown menu showing "Race". The right column has four rows, each with a label and a dropdown menu showing "--": "Band:", "Channel:", "Power:", and "Flight mode:". At the bottom center, there is a large rectangular button with the word "SEND" in orange capital letters.

Label	Value	Label	Value
Band:	A	Band:	--
Channel:	CH 1 - 5865MHz	Channel:	--
Power:	15-25mW	Power:	--
Flight mode:	Race	Flight mode:	--

**SEND**

To apply changes to the video transmitter from the iX14:

1. Power on the video transmitter and ensure it is properly connect to the aircraft receiver.
2. From the Model Adjust menu, touch **Video Tx**.
3. Adjust the Band, Channel frequency, Power level and Mode to the desired values.  
**Pit** mode sets the video transmitter output to very low power for testing in the pits.  
Do not attempt to fly using pit mode.  
**Race** mode sets the video transmitter output to normal power.
4. Press **SEND** to apply the changes. The video transmitter must be properly connected and powered on to apply changes.

# MIXING

Use one of several pre-configured mixes or choose an open programmable (P-Mix) to link two control outputs to one control input.



Mixing functions support:

- Mixing one channel to another channel.
- Mixing a channel to itself.
- Assigning offset to a channel.
- Linking primary channel trim to secondary channel trim.

These pre-configured mixes are available for each model memory:

- Rudder to Aileron/Elevator (ACRO)
- Aileron to Rudder (ACRO)
- Elevator to Flap (ACRO)
- Swashplate (HELI)
- Cyclic to Throttle (HELI)
- Aileron>Rudder (SAIL)
- Aileron>Flap (SAIL)
- Elevator>Flap (SAIL)
- Flap>Elevator (SAIL)

In addition to the pre-configured mixes, 16 programmable mixes are available.



To activate a pre-configured mix:

1. From the Mixing menu, select the desired pre-configured mix.
2. Choose a switch and active position to control the mix or choose the **On** option to have the mix always active.
3. Touch in one of the value boxes to open the options.
4. Adjust the mix values by sliding the circle right or left on the bar or by touching the **+** or **-**. Touch the lock icon (🔒) to adjust both values simultaneously.
5. Touch **OK** to save the settings when the adjustments are complete.

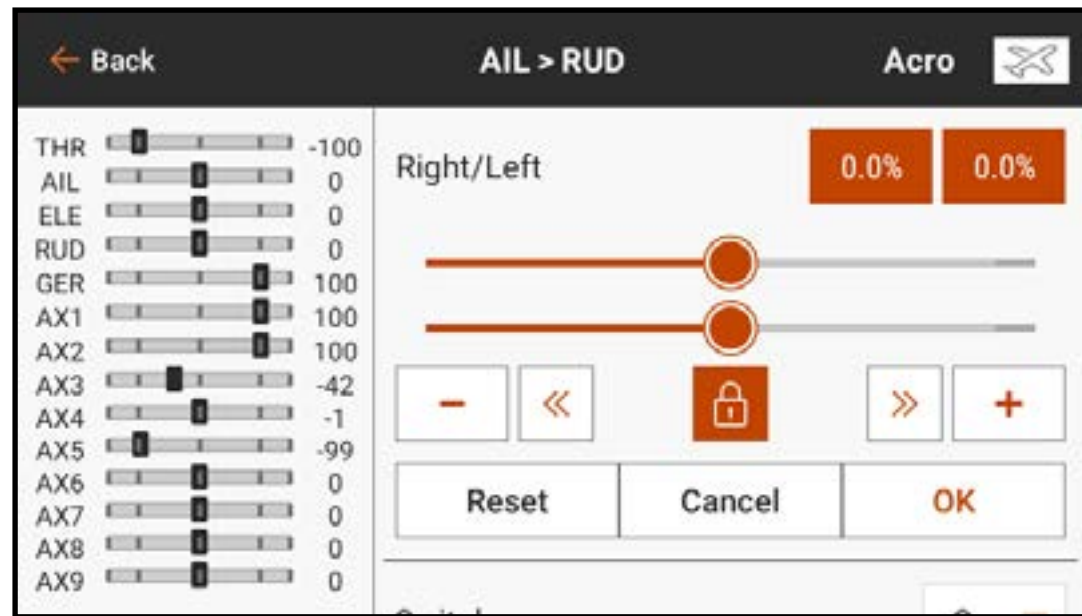

To activate a P-Mix:

1. From the Mixing menu, select the desired available P-Mix.
2. Choose either **Normal** or **Curved** mix type.

The **Normal** mix uses a rate value to define a linear, proportional mix.

The **Curved** mix is a ratio based on a flexible curve with user assigned points.

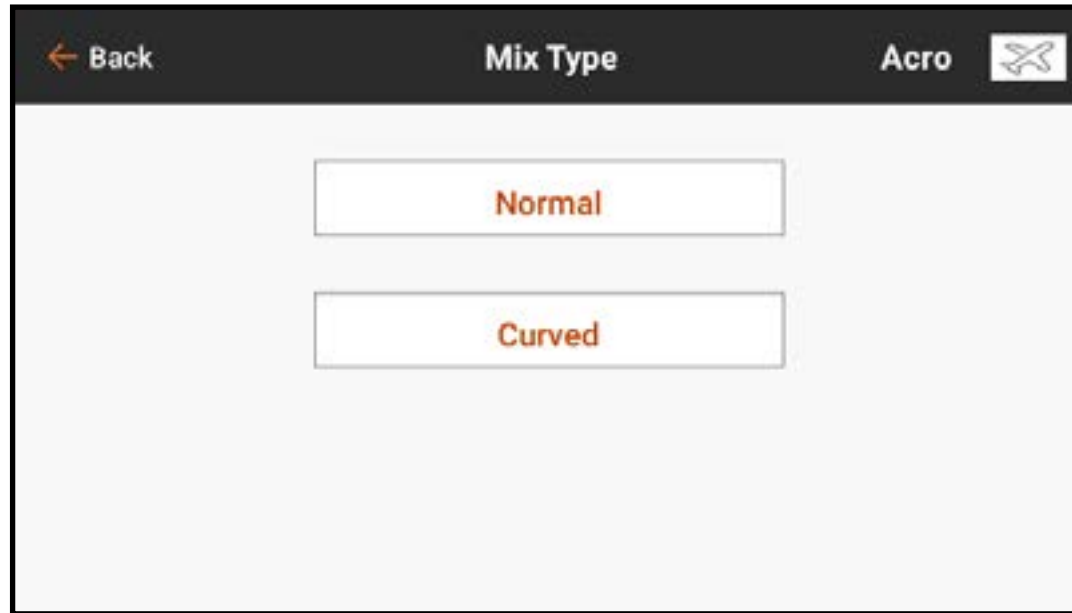

3. Touch the **Name** line to access the keyboard screen to customize the name of the selected mix.
4. Select a channel for input and target. THR > ELE, for example, makes throttle the input and elevator the target channel.



5. Select a **Switch** or **On** to activate the mix. After the switch is selected, the rate values will appear.

6. If using the **Normal** mix type, enter the rate values (i.e., the pre-configured mixes). If using the **Curved** mix type, touch in each point value box to change the curve point position.
7. Slide the circle along the bar to the desired value.
8. Touch **OK** to save the setting for each point.

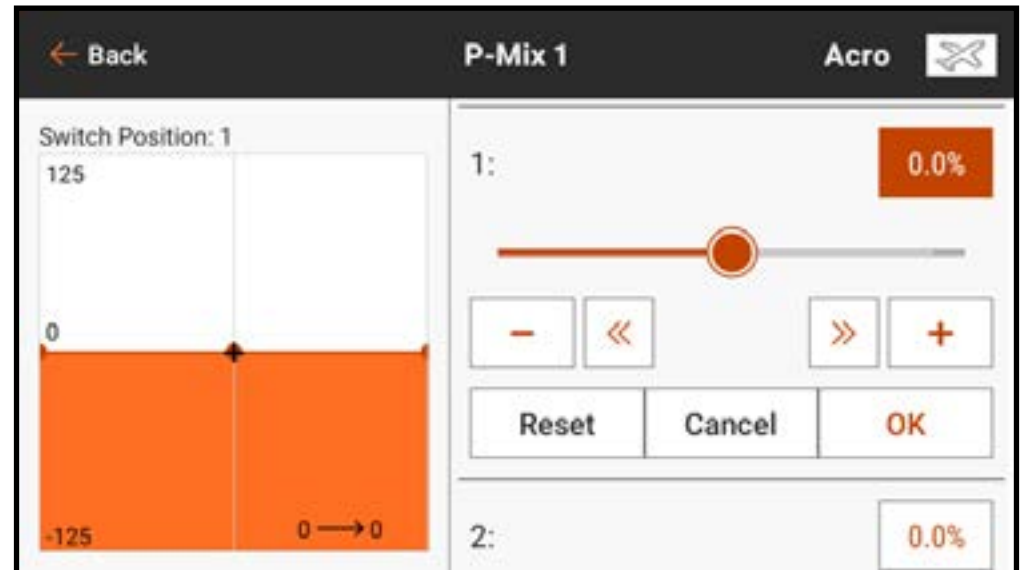
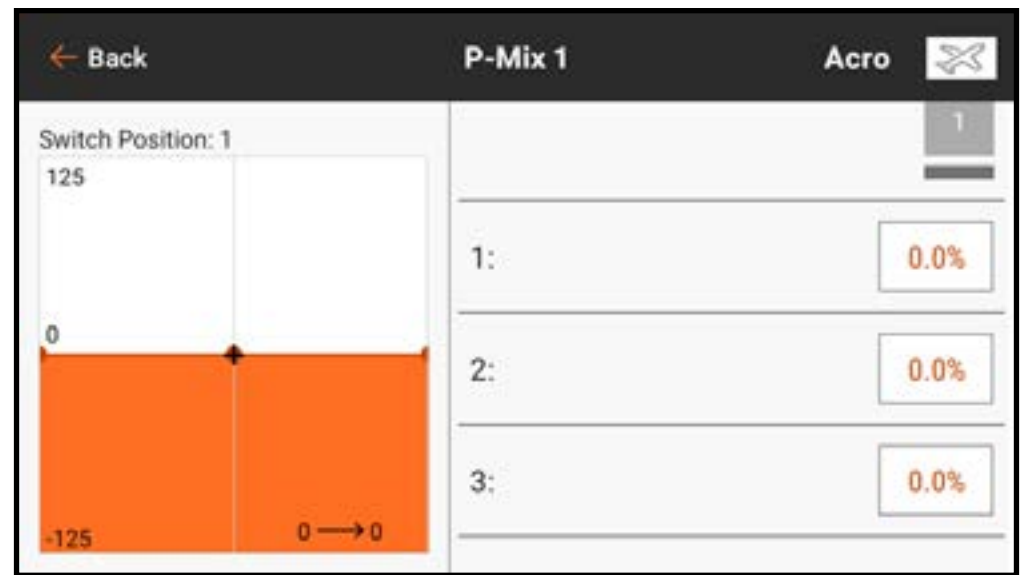

To add more points on the curve:

1. Swipe to the bottom of the options on the right side of the screen.
2. Move the input axis until the black **+** on the graph is in the desired point location on the horizontal axis.



3. Touch the **Add Pt** button. The Curved mix type supports up to seven points on the mix curve.

# RESETTING A PROGRAMMABLE MIX

To quickly reset a programmable mix to the default values:

1. Scroll to the bottom of the programmable mix screen.
2. Touch the **RESET** button
3. Touch **OK** to confirm the resetting of the mix or touch **CANCEL** to return to the mix menu.



## OFFSET

Change the **Offset** value to move the effective center position of the target channel. Positive or negative value determines the direction of the offset. Offset is not available for curve mixes.

## TRIM

Switch **Trim** on to control the target channel trim value with the input channel trim input.

# COMBO MIXING

Combination Mixing creates AND/OR mixing. AND mixing occurs where two conditions must occur to activate the mix. OR mixing occurs when the mix will activate if either of two conditions occurs.

To program Combination Mixing:

1. Activate a programmable mix.
2. Select **Combo Sw.** in the switch selection popup menu. The Combo options appear. Touch and drag the right side of the screen, if necessary, to see the Combo options.
3. Select the desired switch and active switch position for **Switch 1**. The mix is Active when the switch position box is filled.

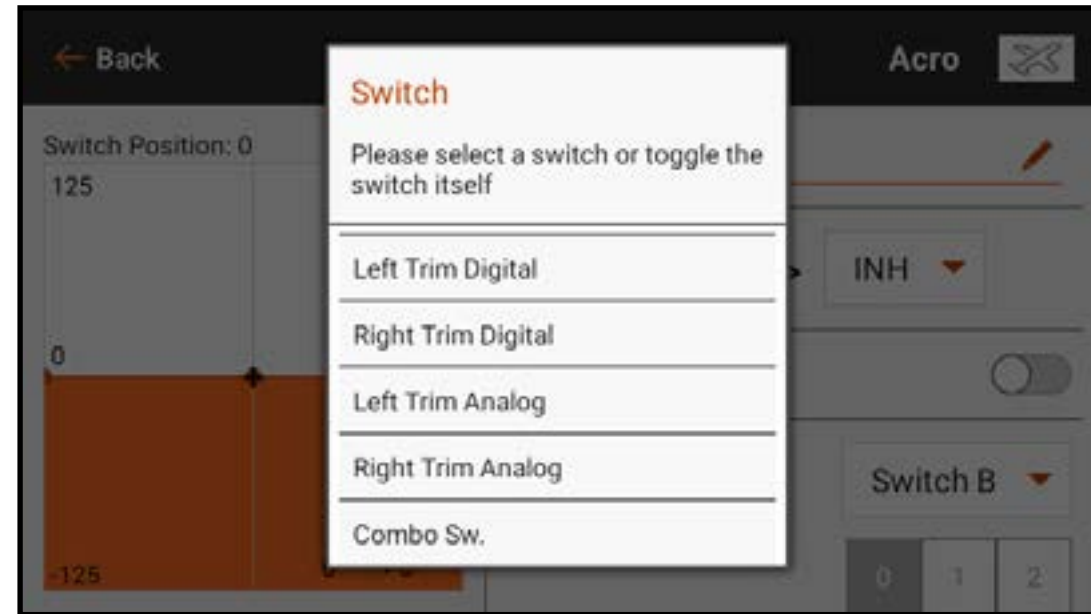



4. Select the **Relation** (**OR**, **AND**)
5. Select the desired switch and active switch position for **Switch 2**. The mix is active when the switch position box is filled. The Status switch at the bottom of the screen gives a visual method to check the mix status with the various switch positions.
6. Press the back arrow ( ← ) to save the combo mix.



## UNDERSTANDING MIXING

0.5% mixing values and back mixing are functions built in to the mixing programming and work seamlessly with the various types of mixing available.

### 0.5 MIXING VALUES

**IMPORTANT:** This function is only available in the default RUD > AIL/ELE mix in aircraft model type.

When adjusting the mix values near center (between 10 and -10), 0.5% mix values are available for fine adjustment capability.

## BACK MIXING

Back Mixing applies to all related servos in a multi servo Aileron/Flapped wing or a multi servo split elevator. Creating a mix to RAL (Right Aileron) or LAL (Left Aileron) will create different results and enable you to use fewer mixes to achieve the desired response.

**Example 1:** Creating a mix AIL > RAL will move the ailerons in opposite directions. Creating a mix AIL > LAL will move the ailerons in the same direction.

**Example 2:** Creating a mix ELE > REL will move the elevator halves together. Creating a mix ELE > LEL will move the elevator halves in the opposite direction (tailerons).

**IMPORTANT:** Be sure the ailerons and/or elevators are plugged into the correct left/right port for this function to work.

## SAILPLANE PRE-CONFIGURED MIXES

When Sailplane is selected as the model type, the iX14 will pre-configure four commonly used mixes. For the following mixes, it is normal to set the offset close to or at the end point because of the geometry of sailplane flap servo linkages. It is also normal to use a significant amount of trim on the flap channels to center the control surfaces with these configurations.

### **Aileron to Rudder (AIL > RUD)**

The Aileron to Rudder mix is commonly used for coordinated turns. When active, as aileron is applied, the rudder moves in the same direction as the turn (right aileron input results in right rudder output). If **Switch** is assigned to Flight Mode, a second **Switch** option allows an additional switch to be assigned to activate up to three aileron to rudder mixes for each flight mode.

## **Aileron to Flap (AIL > FLP)**

The Aileron to Flap mix allows the entire trailing edge of the wing (aileron and flap) to operate as ailerons. When active, as aileron is applied, the flaps also move.

Always program the flaps to move in the same direction as the turn (right aileron input moves the flaps as right ailerons).

## **Elevator to Flap (ELE > FLP)**

Elevator to Flap mix creates additional lift, allowing a tighter turn. The entire trailing edge of the wing (aileron and flap) operates as flaps (camber increase) when elevator is applied.

An offset is provided, which is typically used for Snap Flaps. With Snap Flap, no Elevator to Flap mix occurs until the offset value is reached. Typically, this offset is at 70% up elevator. Beyond 70% up elevator, the down flap mix activates, providing additional lift for aggressive turning (e.g., in tight thermals or racing turns).

## Flap to Elevator (FLP > ELE)

Flap to Elevator mix prevents pitch up tendency that occurs when Crow or Butterfly mixing is applied. This mix is typically used only with the Camber System. The Flap to Elevator mix operates as a curve so the elevator response can be matched to specific points in the spoiler stick travel. This enables the pilot to ensure the elevator compensation is correct throughout the flap range.

For sailplanes with ailerons/tips/flaps, ensure an appropriate Sailplane Type is selected in Model Setup so that tips appear in the transmitter as RAIL and LAIL. Decrease or increase travel on the tip ailerons by creating an AIL > RAIL mix.

# FORWARD PROGRAMMING

Forward Programming is compatible with specific Spektrum products only. Features and use are product specific. Refer to the connected device manual for programming instructions.

The Forward Programming menu is activated in the **Model Setup**, **Menu Setup** screen.

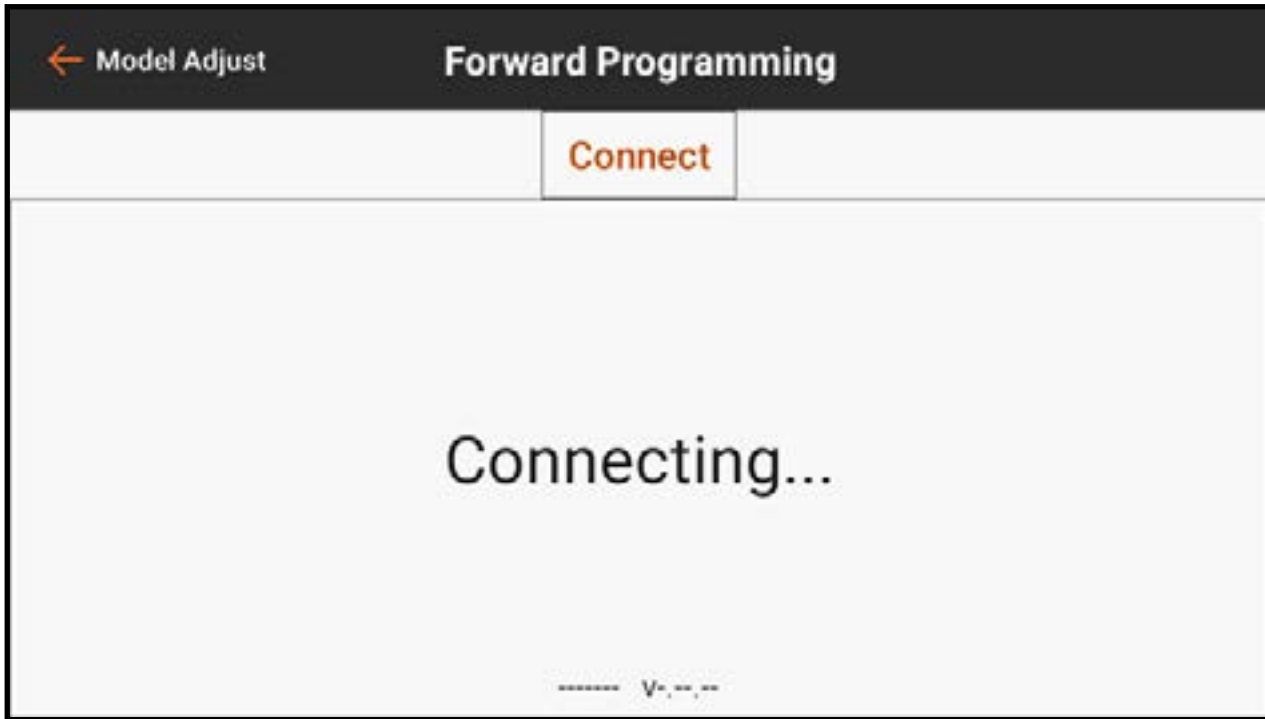

# SEQUENCER

The Sequencer can manage two independent functions activated by a single switch. For example, the gear switch could be assigned to operate the landing gear doors and retractable landing gear. Time delays can be added within a sequence to adjust both when and the speed at which each event takes place. The Sequencer makes it possible to manage opening and closing the landing gear doors with the correct timing to prevent hitting the wheels, all with a flip of the gear switch.

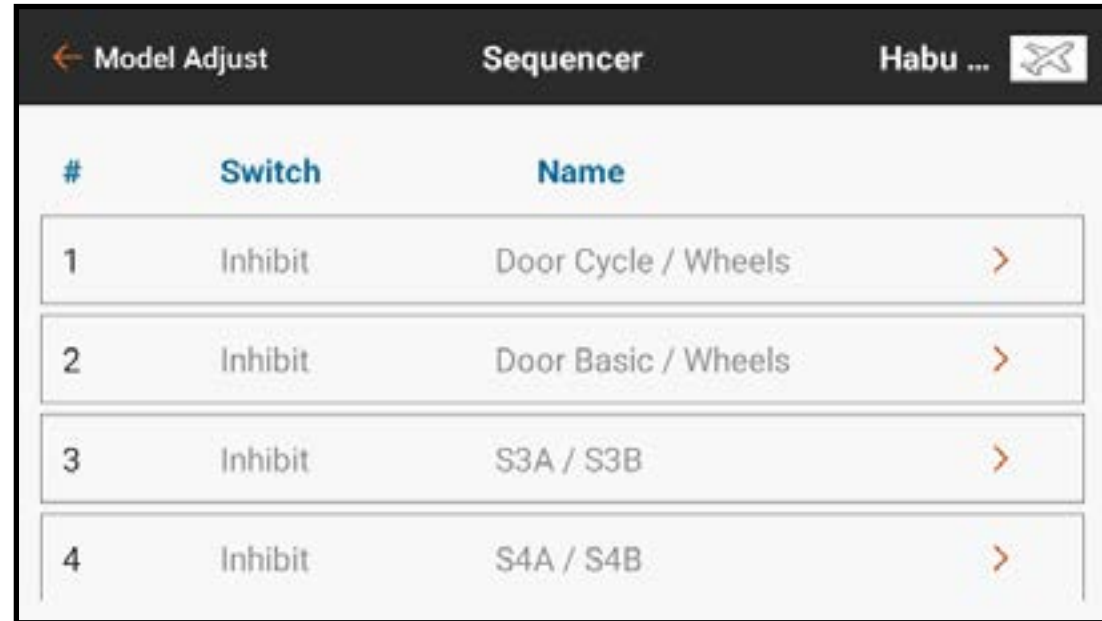

The screenshot shows a mobile application interface titled "Sequencer". At the top left is a back arrow and "Model Adjust". At the top right is "Habu ..." and a close icon. Below the header is a table with four rows. Each row has a number in the first column, "Inhibit" in the second column, and a name in the third column. A right-pointing arrow is in the fourth column of each row.

#	Switch	Name	
1	Inhibit	Door Cycle / Wheels	>
2	Inhibit	Door Basic / Wheels	>
3	Inhibit	S3A / S3B	>
4	Inhibit	S4A / S4B	>



Two built-in sequencers are set up for different styles of gear doors.

- Door Cycle/Wheels: for P-51 style gear doors where the gear doors open first, the retractable landing gear cycles in or out, and the door closes.
- Door Basic/Wheels: for gear door systems that require the door to stay open with the landing gear.

These values are only meant to serve as a baseline and are defaults, but any of the four sequences can be re-named and fully reconfigured. Two additional sequencers are left open for any application.

The total time for the sequence is shown along the horizontal axis of the graph.

The output channel position is shown on the vertical axis. The vertical axis is scaled from -100 to 100 based on the travel adjustment set in the servo setup menu. Each channel has its own independent timeline.

To set a sequencer:

1. Determine the total time for the gear sequence, forward and reverse.
2. Assign a switch to activate the sequence.
3. Assign sequence times for how long the sequence should take, forward and reverse.

The screenshot shows a control interface for a sequencer. At the top, there is a dark header bar with a back arrow, the title "Sequencer", and the name "Habu ..." with a small icon. Below the header, the interface is divided into sections. The first section is labeled "Switch" and contains a dropdown menu set to "Switch A". The second section is split into two columns: "Reverse:" and "Forward:". Each column has a time input field set to "5.0s" and a toggle switch below it. The "Reverse:" toggle switch is currently in the "0" position (white), while the "Forward:" toggle switch is in the "1" position (orange). The third section is labeled "Channel A:" and contains a dropdown menu set to "INH".

4. Swipe up and assign relevant channels. The name of the channels can be changed. These assigned names will appear in the Servo Setup and Channel Assign menus.
5. Set each channel to **Proportional** or **Step**.  
Proportional will allow a smooth transition between points.  
Step will make an instant change from one point to the next.

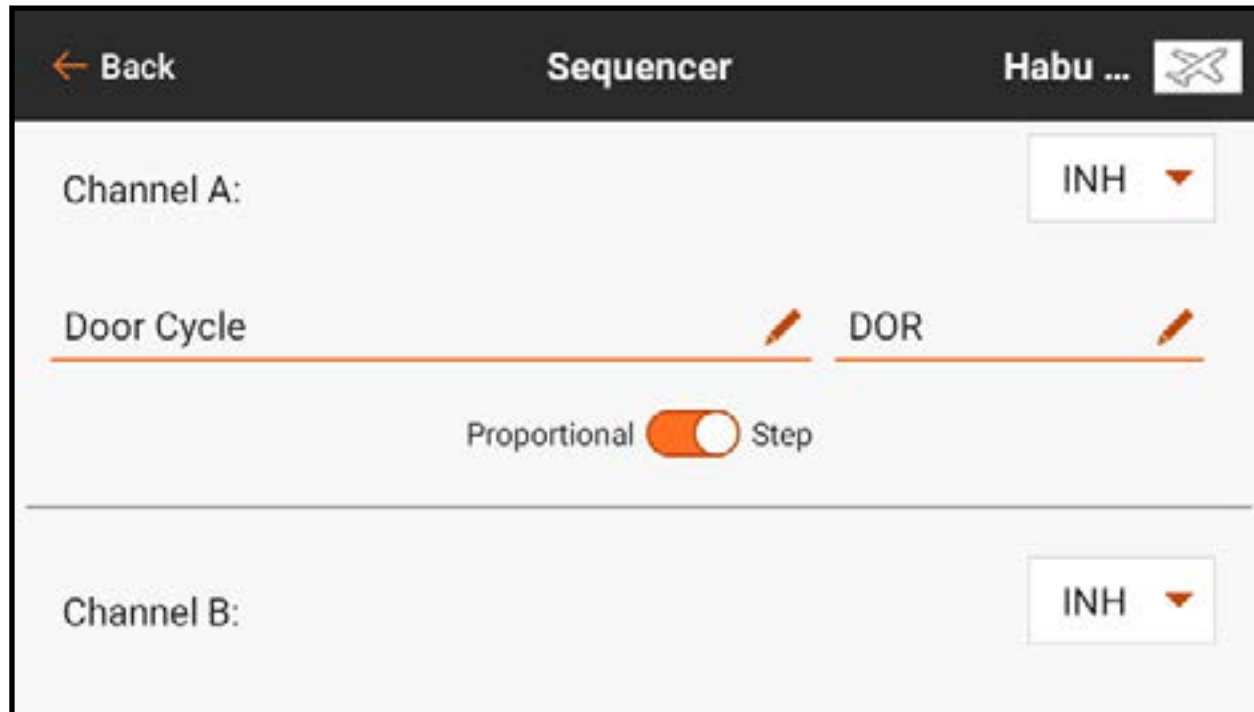

6. Swipe up to see the timeline.

7. Touch the percentage values along the top of the timeline to set the output positions along the timeline for each channel.

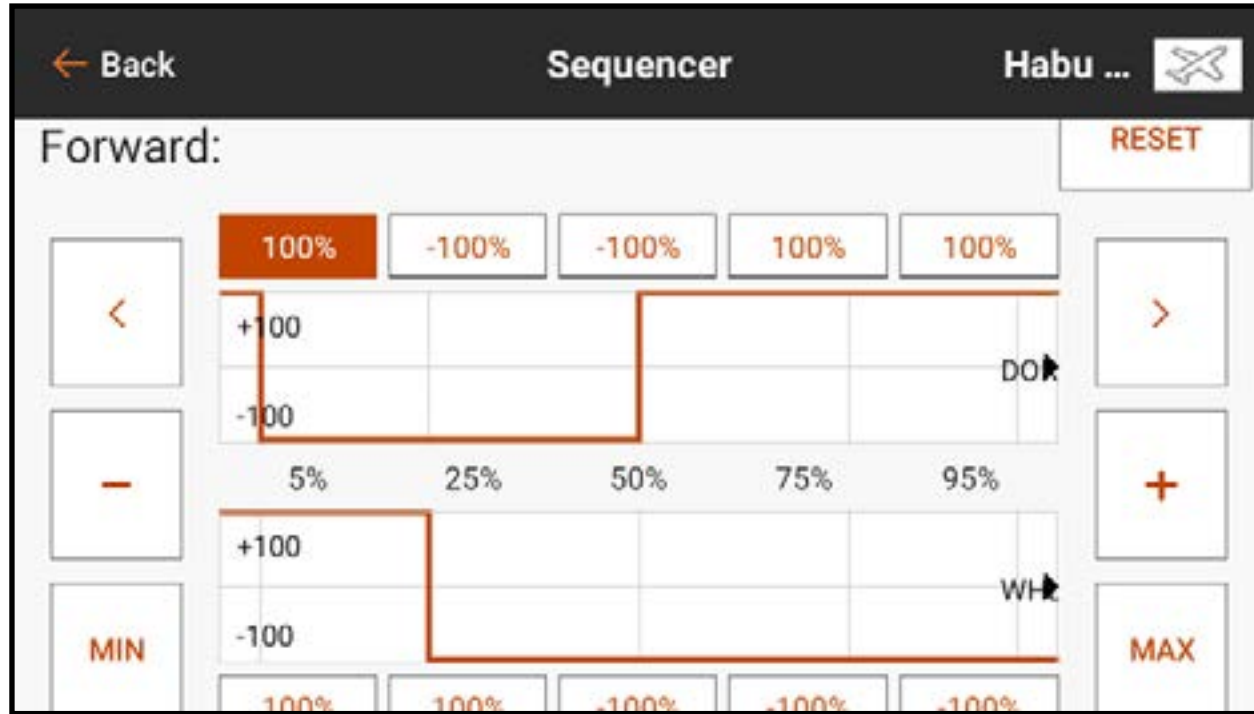

Sequencers can also be configured to manage a mix. For example, with retractable nose wheel steering applications, the steering mix can be disabled when retracted and activated when the wheels are down. During the transition when the wheels are coming down, the nose wheel steering should be disabled until the gear is fully down. Assign the related sequence first. When the mix is configured, the sequence can be selected in the drop down list for the switch selection.

To use this feature, the **Telemetry** menu must first be configured for use with AS3X® technology in Model Setup, and the iX14 must be bound to a compatible AS3X receiver that has been configured for remote gain. Receiver configuration is done separately from the iX14 setup. Refer to the receiver manual for more information. When using a compatible AS3X receiver, the AS3X menu allows:

- Gains to be adjusted from the transmitter
- Selection of the gain adjustment input switch
- Selection of the channel through which gain adjustments are made
- Selection of the flight mode switch
- Real time display of gain values for Roll, Pitch and Yaw

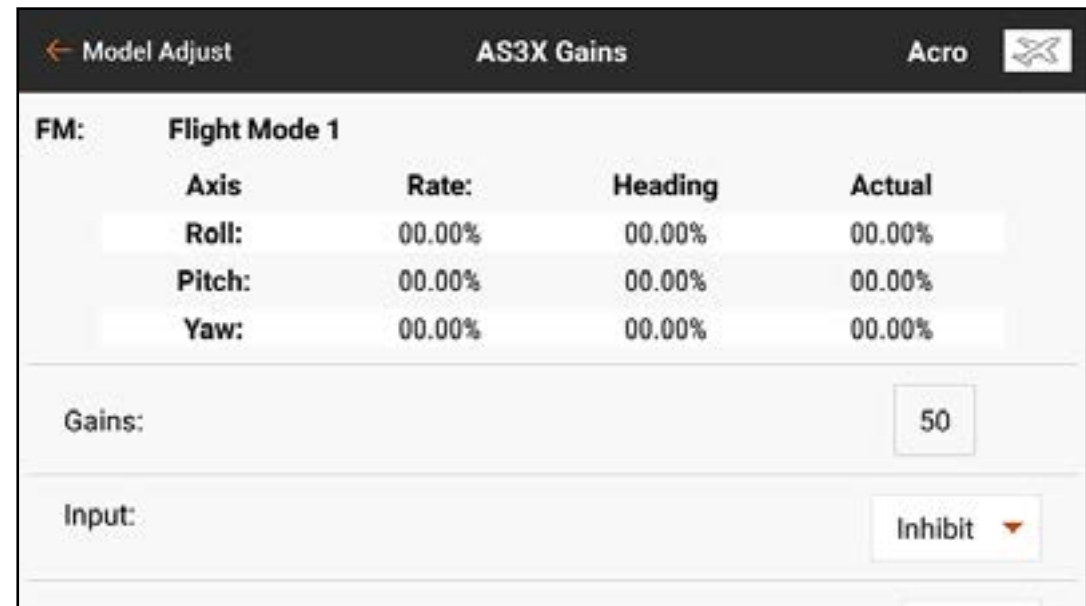

FM:	Axis	Rate:	Heading	Actual
Flight Mode 1	Roll:	00.00%	00.00%	00.00%
	Pitch:	00.00%	00.00%	00.00%
	Yaw:	00.00%	00.00%	00.00%

Gains: 50

Input: Inhibit

The AS3X Gains menu displays the following for each flight mode:

**Axis:** Roll, Pitch and Yaw

**Rate:** Rate gain values

**Heading:** Heading gain values

**Actual:** The current gain value taking into account the priority gain and the stick position of that channel

**Gain:** Represents the gain channel output position. This number is the percentage of the preset gain the receiver is using. 100 will pass through the full gain setting, 50 in this value would mean the receiver is using 50% of the gains set in the receiver configuration. The Gains value affects all axis, heading hold and rate gains that are assigned as RELATIVE. This value can only reduce the gain from the value set in the receiver configuration, it cannot raise the gain above the preset value.

**Input:** Allows the selection of any of the L, LTT, R or RTT Trim switches to adjust the gain.

**Channel:** Must correspond to the channel selected in the AS3X application in the FM Channel Assignment screen

**Switch:** Selects the switch on the transmitter that is used to select the flight modes in the AS3X system. AS3X and Flight Mode share a switch assignment. Assigning a switch in the AS3X menu will set the Flight Mode switch assignment. Conversely, assigning a switch in the Flight Mode menu will set the switch assignment in the AS3X menu.

Relative (REL) must be selected in the AS3X application gain screen to allow adjustable gain from the transmitter.



To configure the AS3X functions:

1. Configure the receiver for remote gain using the AS3X application. In the receiver configuration, each axis under every flight mode must be set to RELATIVE (REL) to connect that gain value to the remote gain channel. Leaving gain settings as ABSOLUTE (ABS) during the setup will mean the gain values are fixed and will not be affected by the remote gain channel.
2. With the aircraft powered on and bound to the iX14, enter the **Telemetry** menu in Model Setup and select **Auto-Config** to set up the telemetry to work with AS3X.
3. From Model Adjust, enter the **AS3X** menu. This menu is scrollable by touching and dragging up or down to show additional information.
4. If not already done in the Flight Mode menu, assign **Switch** to the desired switch.
5. Select the appropriate gain channel to match the assignment during the receiver setup.
6. Select the **Input** switch between the L or R trim switch. This switch will make the actual gain changes.

7. Assign gain values for each flight mode switch position.
8. Confirm any changes made with the assigned switch result in gain reductions in the related fields in the telemetry feedback display.

 **WARNING:** Always confirm control surface directions and gyro response after making any changes to AS3X receivers. Always perform a thorough pre-flight inspection to catch incorrect control surface configurations prior to flight.

# DIFFERENTIAL

The Differential menu allows for an increase or a decrease in the amount of differential travel between aileron control surfaces. By reducing the amount of aileron surface travel in one direction, differential helps eliminate adverse yaw from the application of aileron control.

The Differential menu option only appears when any multi aileron servo wing type is selected in Aircraft Type in the Model Setup menu.

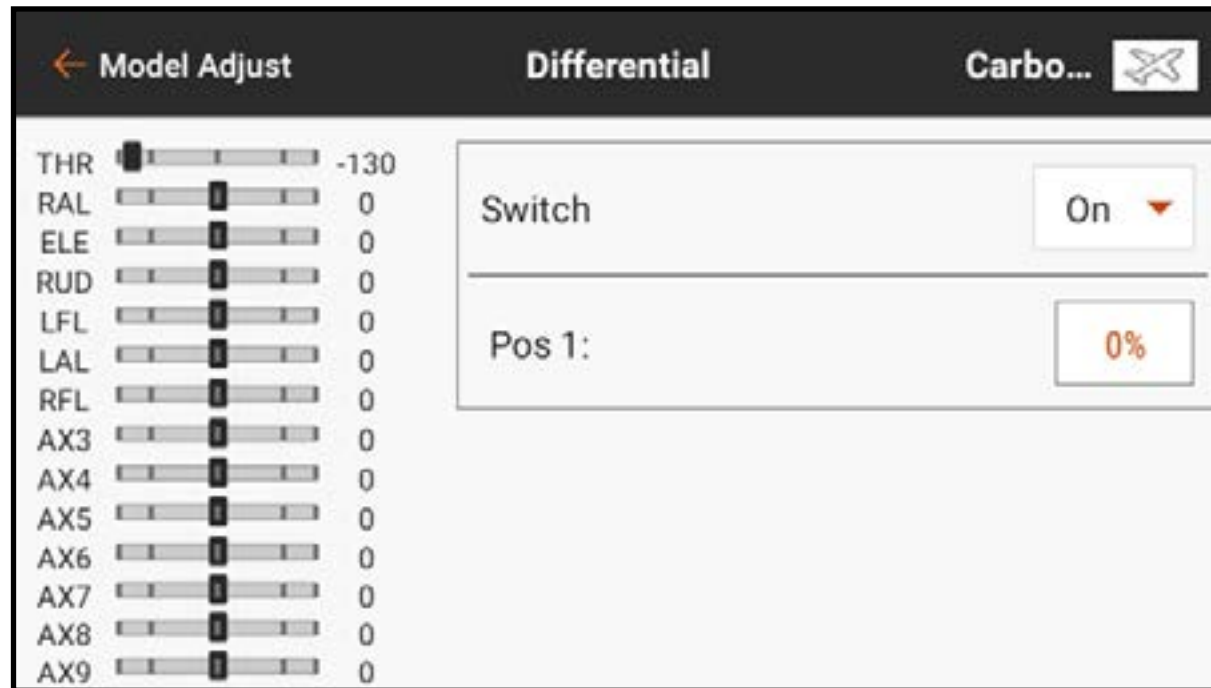

To adjust the Differential:

1. From the Model Adjust menu, touch **Differential**.
2. Set **Switch** to **On** to use a single value for differential, or assign a switch from the popup menu.
3. Touch the value box to adjust the differential value. A positive differential value decreases the amount of down aileron travel of both ailerons. A negative differential value decreases the amount of up aileron travel of both ailerons. A setting of 100 eliminates down travel entirely. A setting of  $-100$  eliminates up travel. Selecting 50 or  $-50$  reduces the down or up travel by half.
4. When the value is set, touch **OK** to save the setting.



# V-TAIL DIFFERENTIAL

The V-Tail Differential menu allows for increasing or decreasing the amount of differential between tail control surface throws. This menu option only appears when **V-Tail A** or **V-Tail B** is selected in **Model Setup, Aircraft Type**.

The screenshot shows the 'V-Tail Differential' menu within a 'Model Adjust' interface. On the left, there is a list of control surfaces with their corresponding values:

Control Surface	Value
THR	-130
RAL	0
REL	0
LEL	0
LFL	0
LAL	0
RFL	0
AX3	0
AX4	0
AX5	0
AX6	0
AX7	0
AX8	0
AX9	0

On the right side of the menu, there are two main settings:

- Switch:** A dropdown menu currently set to 'On'.
- Pos 1:** A numerical input field currently set to '0%'.

The top of the menu includes a back arrow labeled 'Model Adjust', the title 'V-Tail Differential', and a 'Carbo...' button with an airplane icon.

To adjust the V-tail differential:

1. From the Model Adjust menu, touch **V-Tail Differential**.
2. Set **Switch** to **On** to use a single value for differential, or assign a switch from the popup menu.
3. Touch the value box to adjust the differential value. A positive differential value decreases the amount of down travel of both tail surfaces. A negative differential value decreases the amount of up travel of both tail surfaces. A setting of 100 eliminates down travel entirely. A setting of  $-100$  eliminates up travel. Selecting 50 or  $-50$  reduces the down or up travel by half.
4. When the value is set, touch **OK** to save the setting.

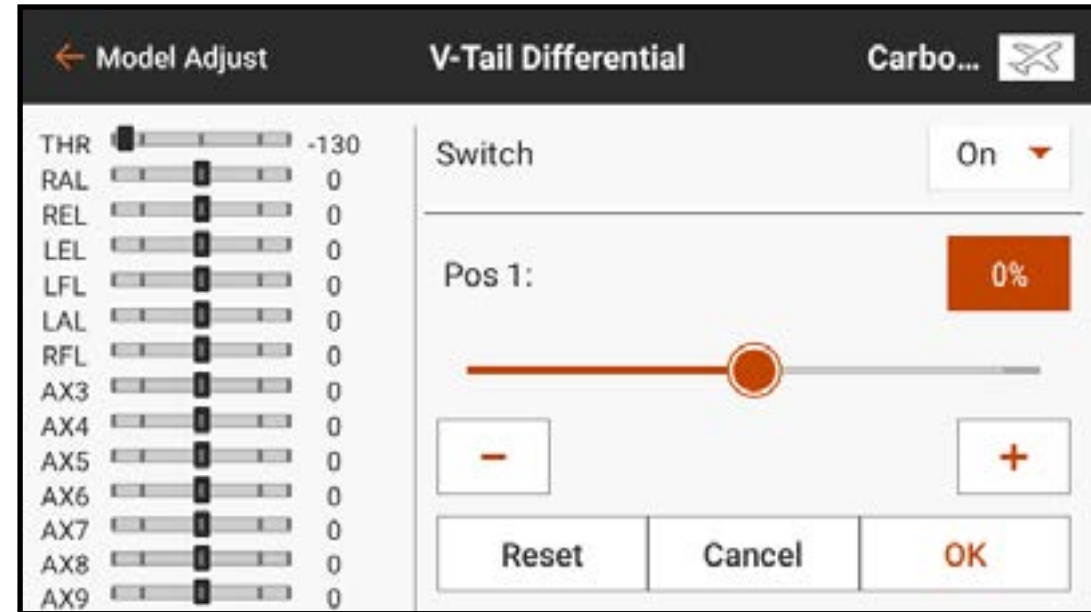

# FLAP SYSTEM

The Flap System menu enables flap programming as well as flap to elevator mixing. To make the Flap System menu available, choose a wing that includes flaps in Aircraft Type in the Model Setup menu. Settings include: switch input, flap position, elevator mix value, and speed of movement. This menu may be scrollable depending on how many switch positions are applied.

The screenshot shows the 'Flap System' menu within a 'Model Adjust' interface. The menu is titled 'Flap System' and includes a 'Carbo...' button with a wing icon. The main area is divided into two columns. The left column lists various flap and servo channels with their corresponding values:

Channel	Value
THR	-130
RAL	0
REL	0
LEL	0
LFL	0
LAL	0
RFL	0
AX3	0
AX4	0
AX5	0
AX6	0
AX7	0
AX8	0
AX9	0

The right column is labeled 'Switch' and contains an 'Inhibit' button with a dropdown arrow.

To program the Flap System:

1. From Model Adjust, touch **Flap System**.

2. Touch the **Switch** input box to select the desired switch or Flight Mode.

**TIP:** If an analog input device is selected (stick, slider or knob), the flaps will not operate in direct response to moving the input. Using an analog input for the flap system is similar to analog switch setup.

3. Touch the **POS** value boxes to assign the flap travel values for each switch position.





4. If necessary, add any required elevator mixing for each of the switch positions by touching in the **Elev** value box and sliding the circle along the bar. This pre-defined mix compensates for pitch changes that occur when the flaps are deployed. The elevator compensation should be tuned so the model maintains level flight at each flap position. Touch **OK** to save the value.



5. Adjust the flap speed to slow the flap movement for more realistic operation or to help prevent a rapid change in flight characteristics when the flaps are deployed. Flap speed options range from 0.0 to 360 seconds. The value selected is the amount of time it will take for the flaps to move from one switch position to the next. When the desired time is entered, touch **OK** to save the value.



# PITCH CURVE

The Pitch Curve menu is available by default for helicopter model types. Pitch curves are tied to the flight modes because they are often tied to complicated mixes. The graph represents how the pitch output command will respond to the pitch stick movements. On the graph, the horizontal axis represents the movement of the throttle stick, and the vertical axis represents the pitch command. Each flight mode has a different Pitch Curve, which must be set up individually.

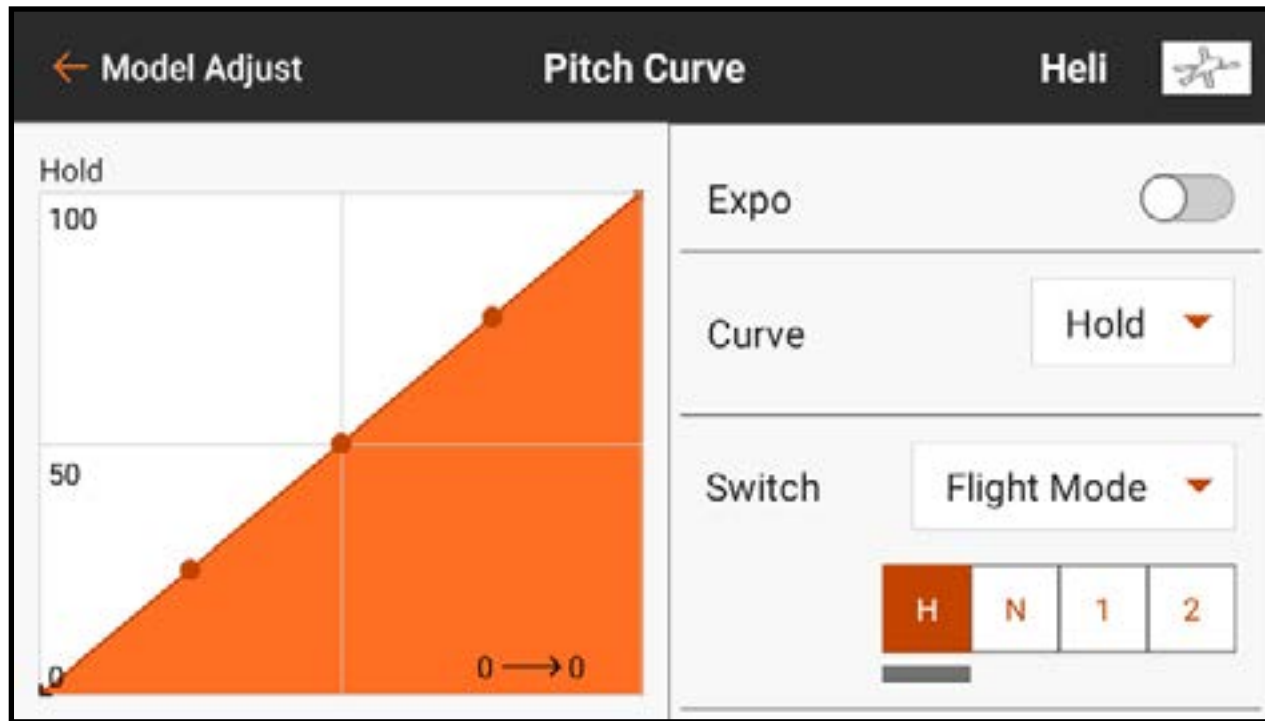

Each flight mode

has a different Pitch Curve, which must be set up individually.

To set up a pitch curve:

1. From Model Adjust, touch Pitch Curve to open the scrollable menu.
2. Touch the value box for each point to adjust the value. Increase or decrease the value to achieve the desired pitch output at that stick position.
3. Touch **OK** after changing each point value to save the value setting.

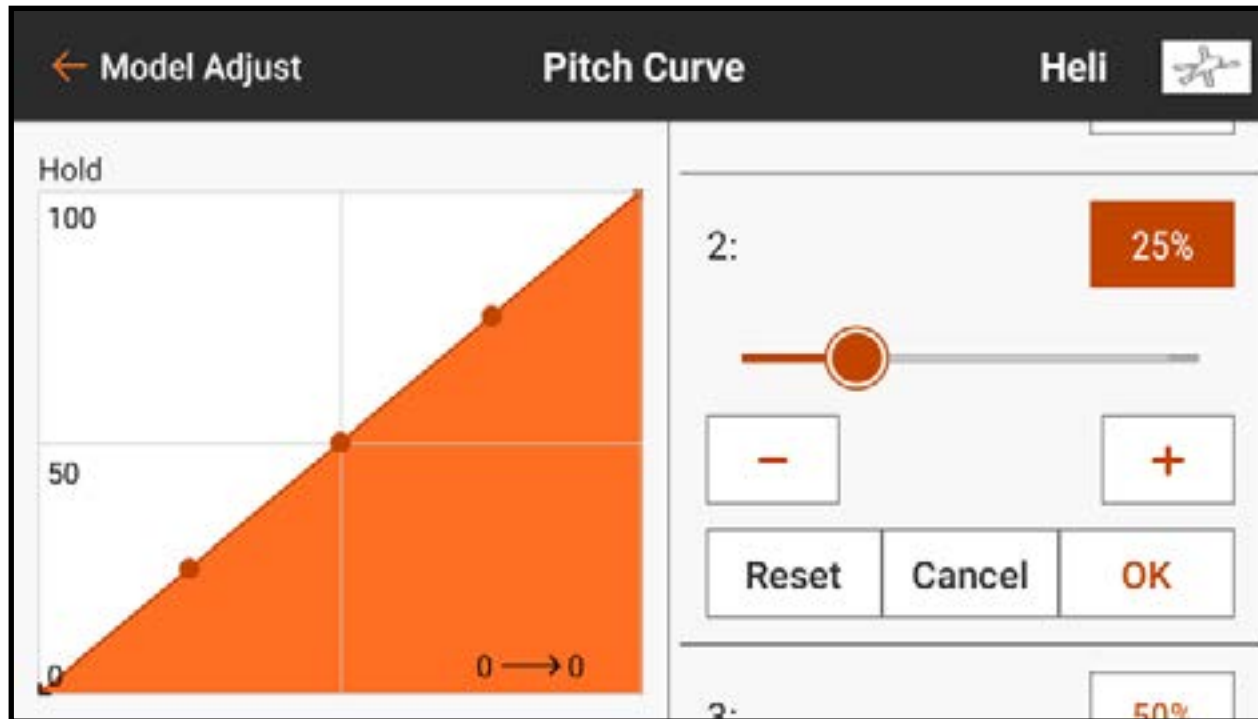

4. To add points to the curve, move the throttle stick to the desired position along the curve. Touch the **Add Pt** button at the bottom of the menu.

Throttle position

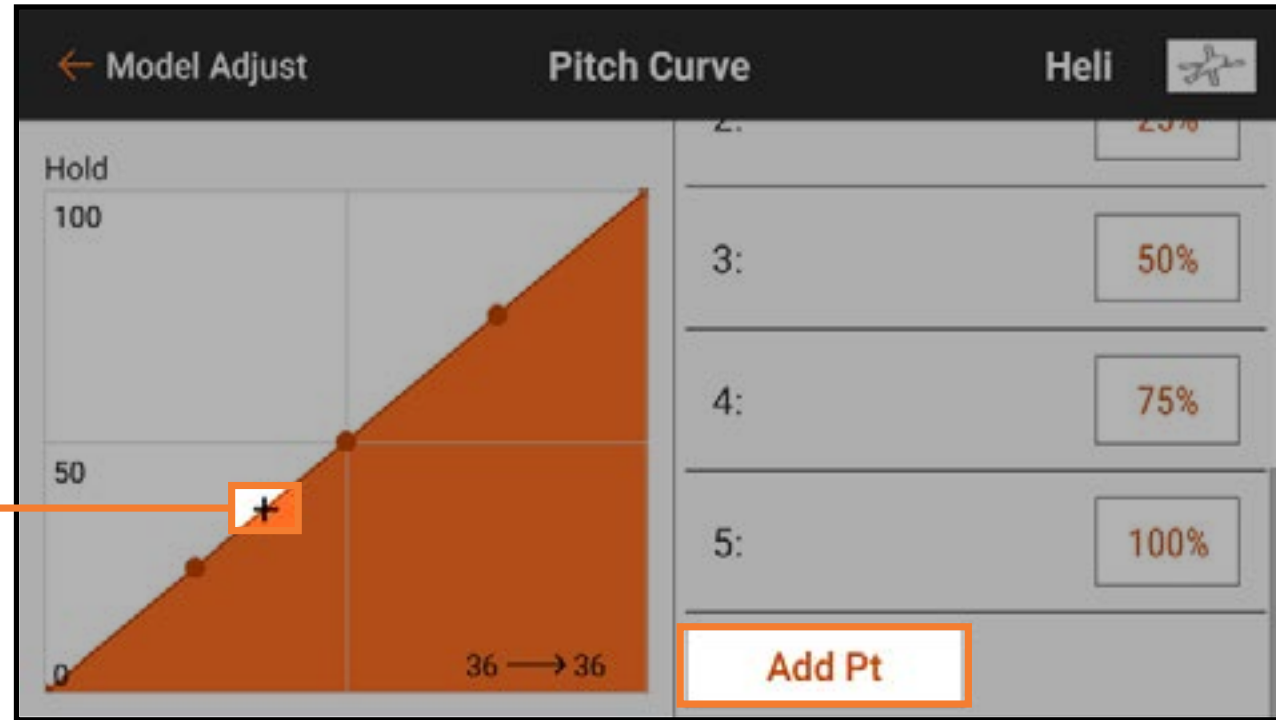

5. To delete points from the curve, move the throttle stick over the point to be deleted. Touch the **Del Pt** button at the bottom of the menu.

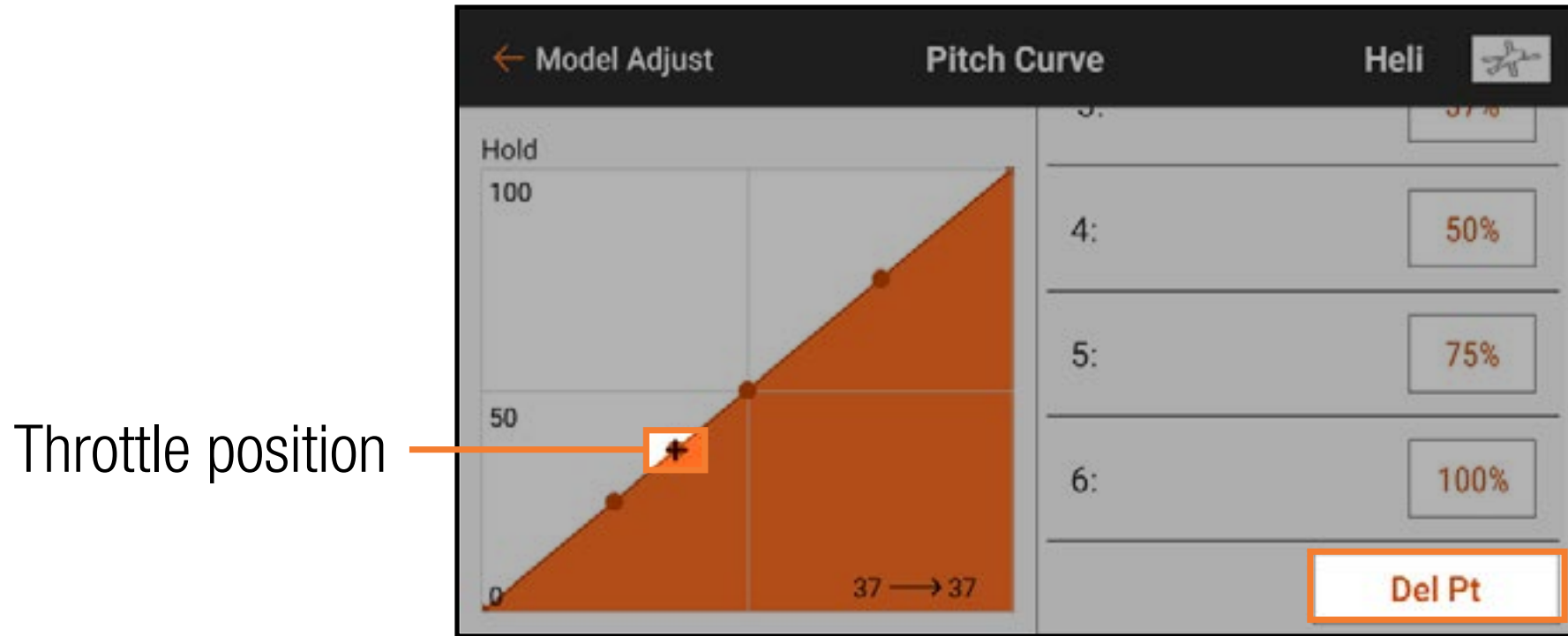

6. Activate **Expo**, if desired, to smooth the curve to prevent abrupt change in pitch response.

7. Touch the back ( ← ) arrow to return to the Model Adjust menu.

## ACRO PITCH CURVE

A pitch curve is also available for Acro models. The Acro pitch curve operates in the same manner as the helicopter pitch curve, but can be assigned to any stick, switch, or flight mode.

To activate the Acro pitch curve:

1. From Model Setup, touch **Aircraft Type**.
2. Touch **AIRCRAFT OPTIONS** in the top menu bar.
3. Toggle the switch to activate **Pitch Curve**.

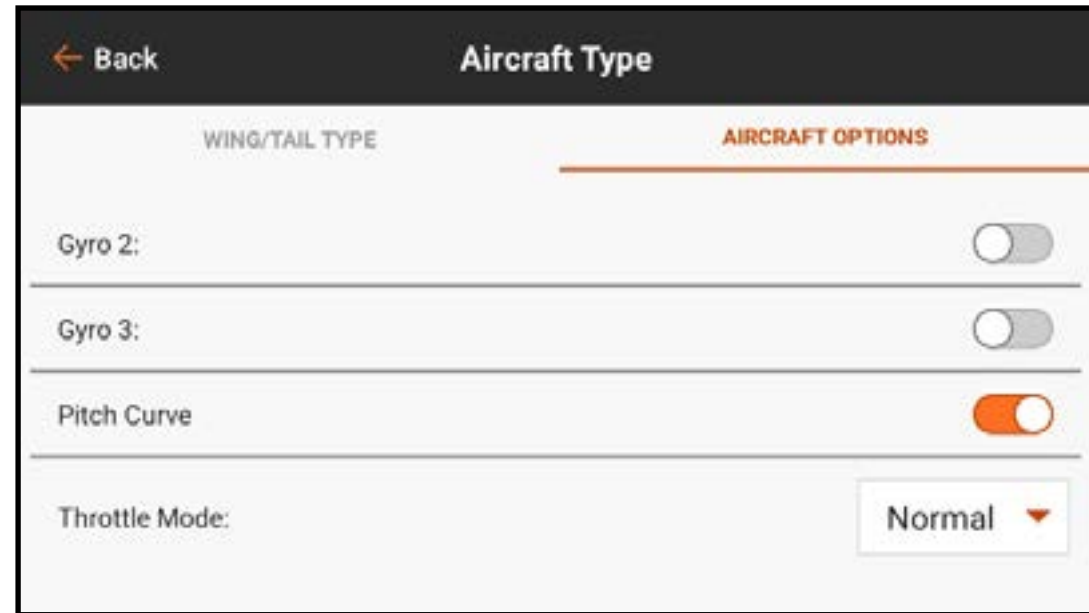

4. Touch the back arrow ( ← ) to return to Model Setup.
5. Touch **Channel Assign**.
6. Touch **RX PORT ASSIGNMENT** in the top menu bar.

CHANNEL INPUT CONFIG		RX PORT ASSIGNMENT	
1 THRO:	Throttle ▼	2 AILE:	Right Ail ▼
3 ELEV:	Elevator ▼	4 RUDD:	Rudder ▼
5 GEAR:	L Flap ▼	6 AUX1:	Left Ail ▼
7 AUX2:	R Flap ▼	8 AUX3:	Aux 3 ▼
9 AUX4:	Aux 4 ▼	10 AUX5:	Aux 5 ▼



7. Assign the pitch output by selecting an open receiver port and choosing **Pitch** from the popup list.

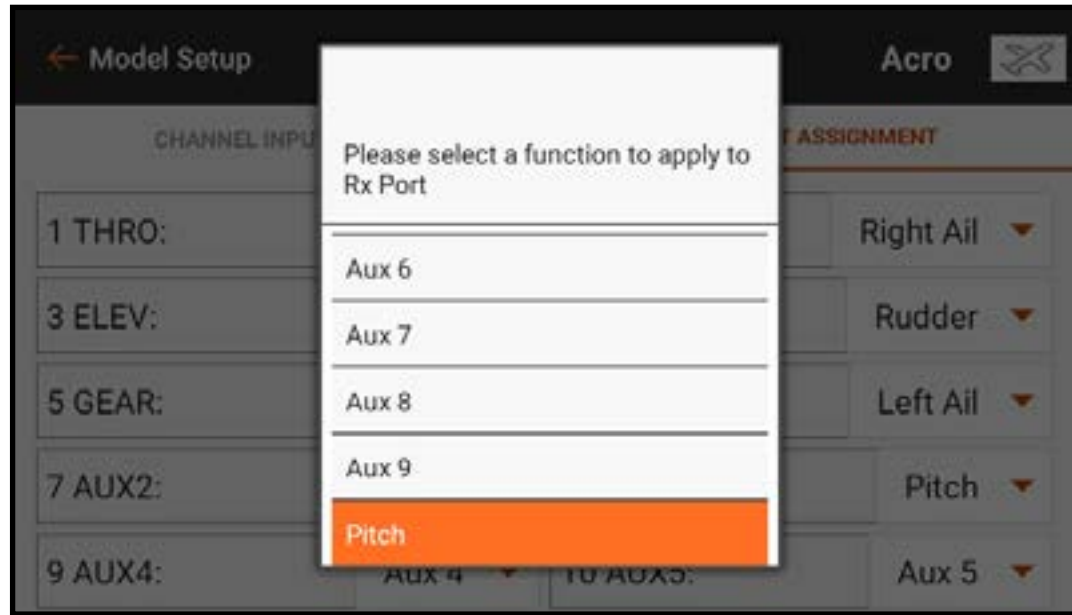

8. From **Model Adjust**, touch **Pitch Curve**. Assign a switch and program the pitch curve using the same steps as the heli programming above.

## SWASHPLATE

The Swashplate menu applies to models that require swashplate mixing at the transmitter. Swashplate is available when the Model Type is Helicopter and the Swashplate Type is set to anything other than Normal in Model Setup. This menu manages swashplate mixes not commonly used with flybarless control systems, which handle mixing on the model.

 **WARNING:** Disconnect the motor from the ESC or set up and activate **Throttle Cut** in **Model Adjust** prior to adjusting the swashplate settings to ensure the power system cannot engage during setup.

Below is a common 3D swashplate setup for models using swashplate mixes:

1. From Model Setup, touch **Swashplate Type** to select the correct swashplate type.
2. Adjust servo horn positions so they are neutral at center stick (zero pitch).
3. Connect the linkages with the collective pitch stick centered (zero pitch).
4. Adjust the servo to swashplate linkages so the swashplate is level.
5. Adjust the rotor head linkages so mixing arms are neutral and the blades are at zero pitch when the collective pitch stick is centered.

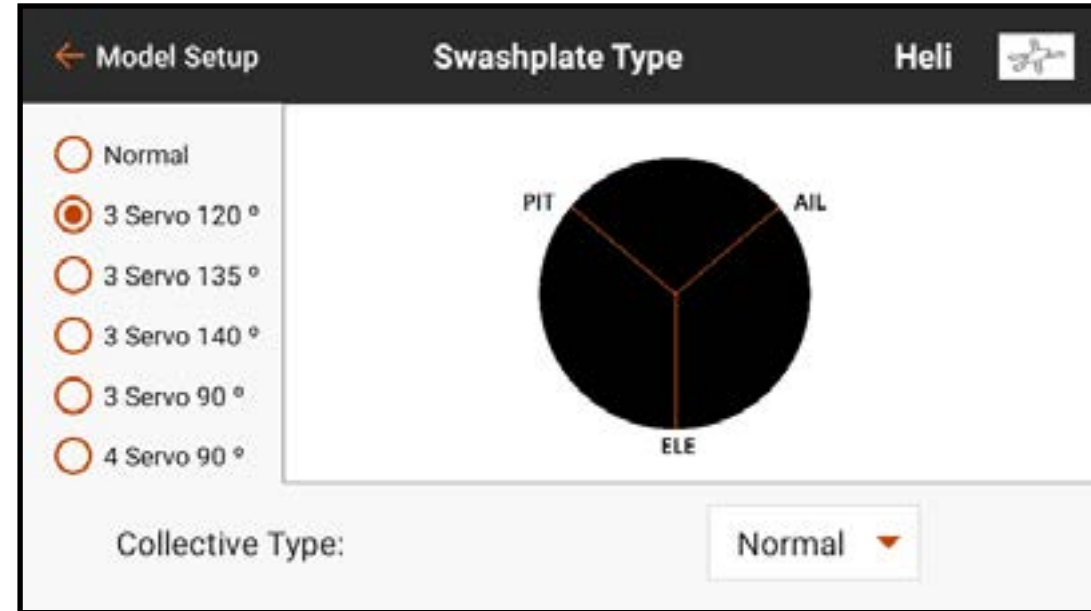

6. Use servo reversing to ensure the swashplate is moving correctly for each control input. At this step, the swashplate does not have to respond in the correct direction, but it is critical it tilts correctly with pitch and roll and moves up and down with pitch.
7. Change the values in the Swashplate menu to manage the direction of the swashplate. Change the value to negative to reverse the function. The percentage value represents travel. A small amount of trim is acceptable to find the neutral point of each servo. Make fine trim changes mechanically for neutral at zero pitch. Avoid using the Servo Setup menu for trim and travel changes with swashplate mixes enabled.

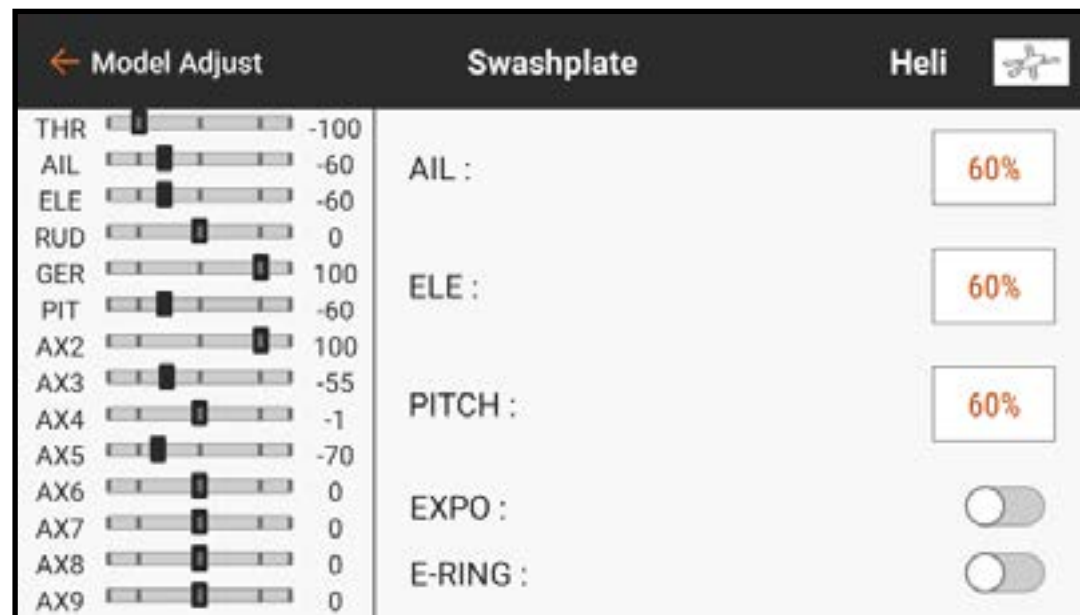

## ELECTRONIC E-RING

Electronic E-Ring prevents over driving servos by limiting servo travel if the sum of your cyclic and pitch inputs exceeds servo limits.

# ELEVATOR COMPENSATION

The **Elevator Compensation** setting allows for adjusting the reaction time of the aileron and pitch servos in a 120° swashplate setup. This allows for all 3 servos to reach full travel at the same time. Select a number from the popup menu to adjust the delay of the aileron and pitch channels with elevator input. The menu gives a scale from 1 to 30, with 1 being the least amount of delay and 30 being the greatest. Check the effects of the mix with the monitor on the left side of the Swashplate menu screen.

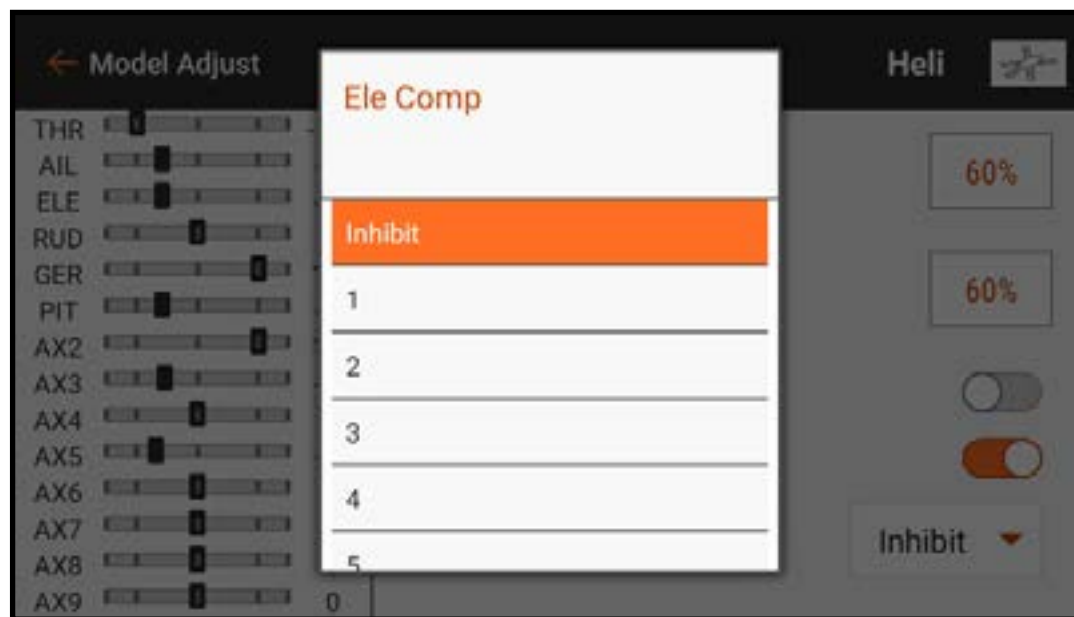

# GYRO

Gyro options for Heli and Acro model types are considerably different.

## HELI GYRO

The Gyro menu is enabled to manage tail gyro gain when the Model Type is set to Helicopter. Touch Switch to select a switch or **On**. The number of gyro gain positions will correlate to the switch chosen. If **On** is selected, only one position is set. Select a channel to assign to the gain; this is the channel the gain signal from the gyro needs to be plugged into on the receiver. Most gyros will use one side of the gain channel for heading hold and the opposite side for rate mode. Consult the gyro manual for more information.

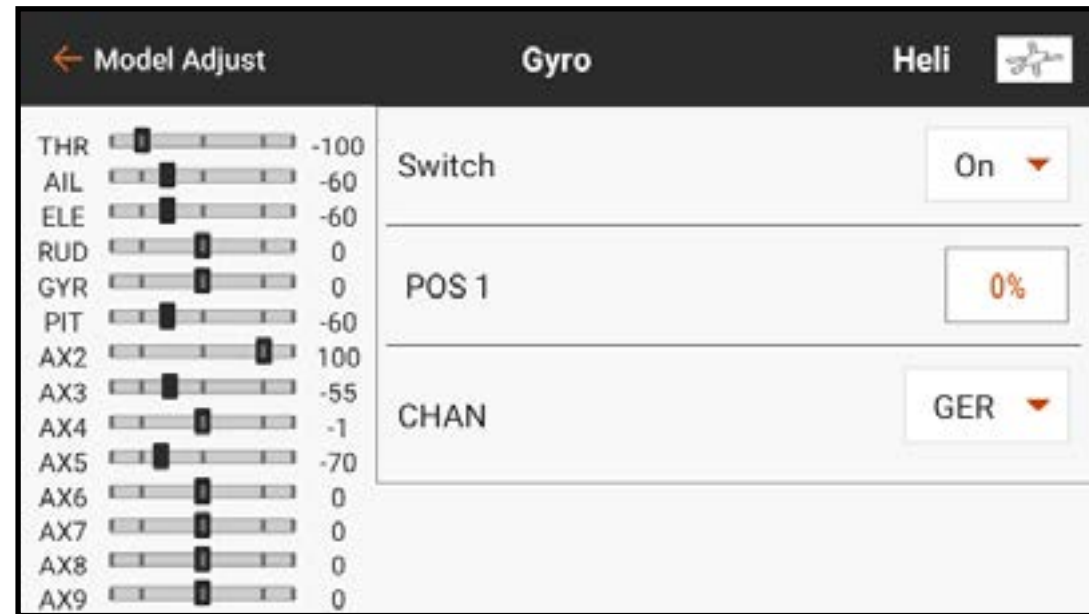

## ACRO GYRO

Unlike Heli configurations, Acro Gyro menus use a curve mix to enable the pilot to achieve the expected flight response. It is common to use the gyro menu to mix gain values so deflecting the control stick reduces the gain, preventing the gyro from fighting flight commands. Gyro menus for the acro model type must be enabled in the **Model Setup, Aircraft Type** menu under the **AIRCRAFT OPTIONS** tab. Possible selections include a 3-Axis gyro or up to 3 single axis gyros.

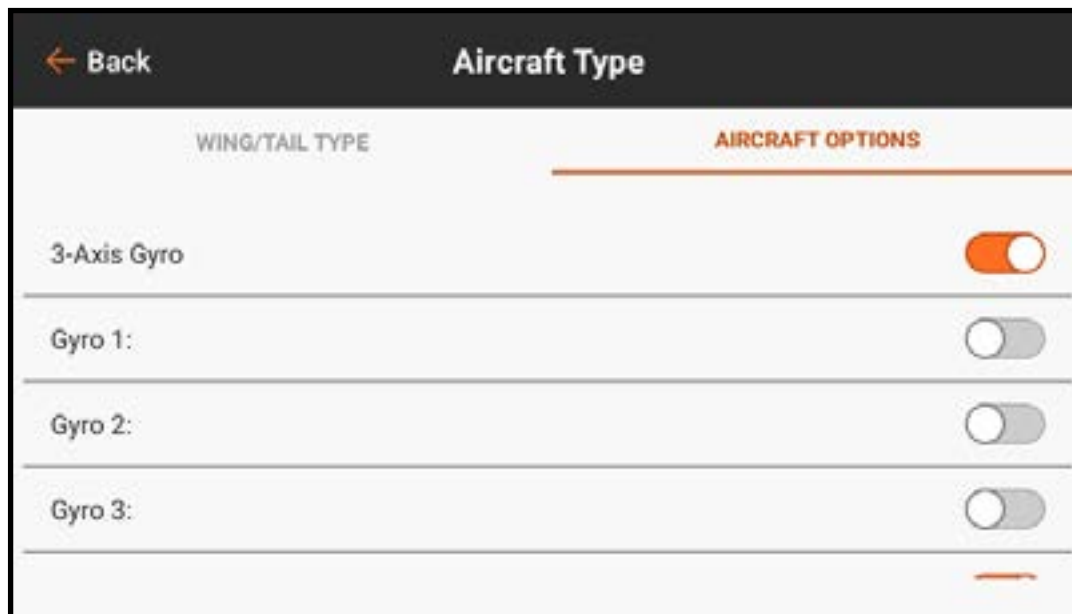



## 3-AXIS GYRO

With the 3-axis gyro function activated in Model Setup, Aircraft Type, Aircraft Options touch 3-Axis Gyro in Model Adjust.

Select a switch to activate the gyro.

The screenshot shows the 'Model Adjust' screen for the '3-Axis Gyro' function. The interface includes a back arrow, the title 'Model Adjust', the function name '3-Axis Gyro', and an 'Acro' mode icon. On the left, there is a list of 13 sliders with their current values: THR (-100), AIL (0), ELE (0), RUD (0), GER (-100), PIT (-100), AX2 (-100), AX3 (-55), AX4 (-1), AX5 (-70), AX6 (0), AX7 (0), AX8 (0), and AX9 (0). On the right, there is a 'Switch' dropdown menu currently set to 'Inhibit'.

Control	Value
THR	-100
AIL	0
ELE	0
RUD	0
GER	-100
PIT	-100
AX2	-100
AX3	-55
AX4	-1
AX5	-70
AX6	0
AX7	0
AX8	0
AX9	0

Switch: Inhibit

Select a switch to activate the gyro.

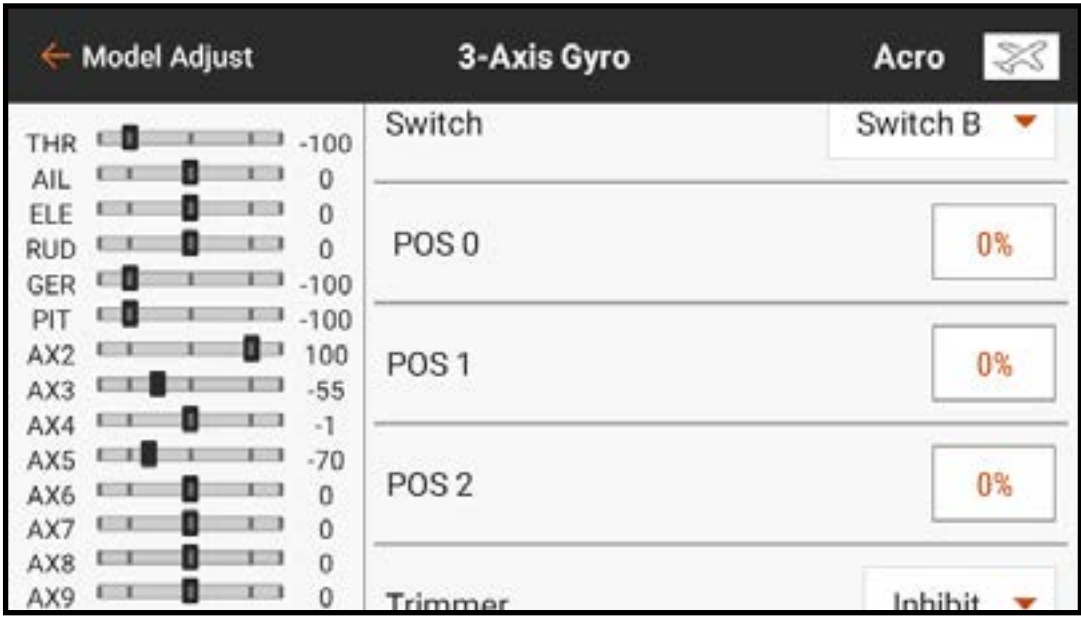

Select the percent value for each of the switch positions to adjust the gyro gain value.

Add a Trimmer button to enable fine tuning adjustment of the gyro gain in the air.

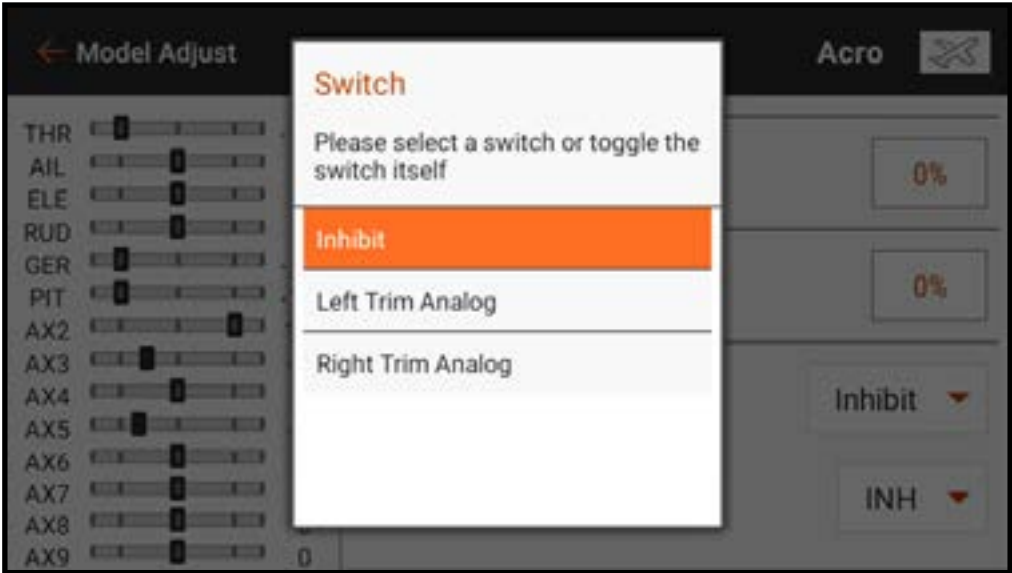

Select an open Channel for the gyro gain adjustment. This is the channel the gyro gain lead should be connected to. Consult the instructions included with your gyro for connection information.

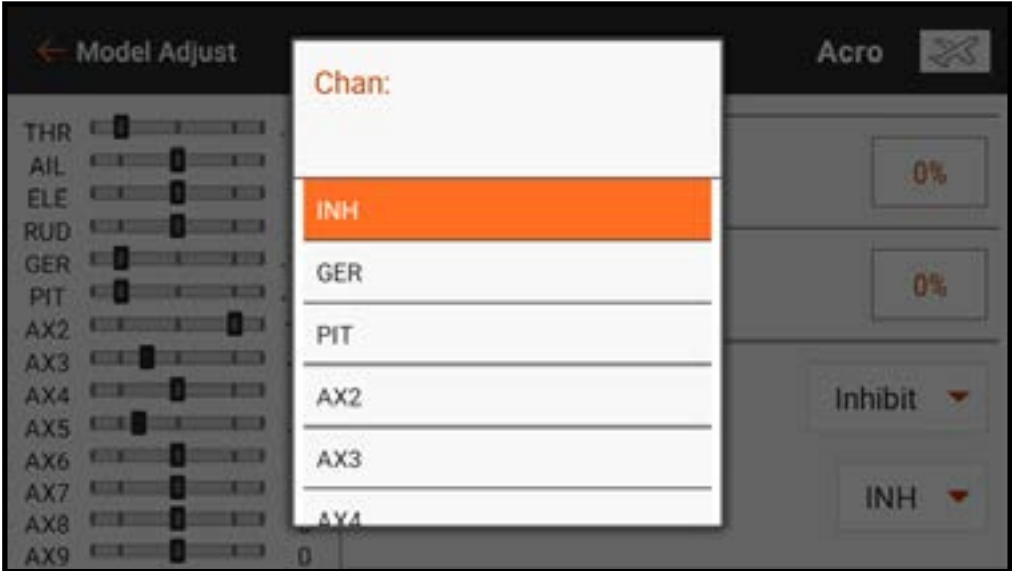

# SINGLE AXIS GYRO

In Model Setup, Aircraft Type, Aircraft Options select Gyro 1, 2 and/or 3 to activate the single axis gyro function. In Model Adjust touch Gyros to open the gyro menu.

← Model Setup Gyros Acro

**Gyro 1**

THR		-100	Name:	Gyro 1
AIL		0	ABR:	GY1
ELE		0	Gyro Type:	Aircraft ▼
RUD		0	Gain:	Inhibit ▼
GER		-100		
PIT		-100		
AX2		100		
AX3		-55		
AX4		-1		
AX5		-70		
AX6		0		
AX7		0		
AX8		0		
AX9		0		

**Gyro Type** defines how the curve will respond depending on gyro functionality.

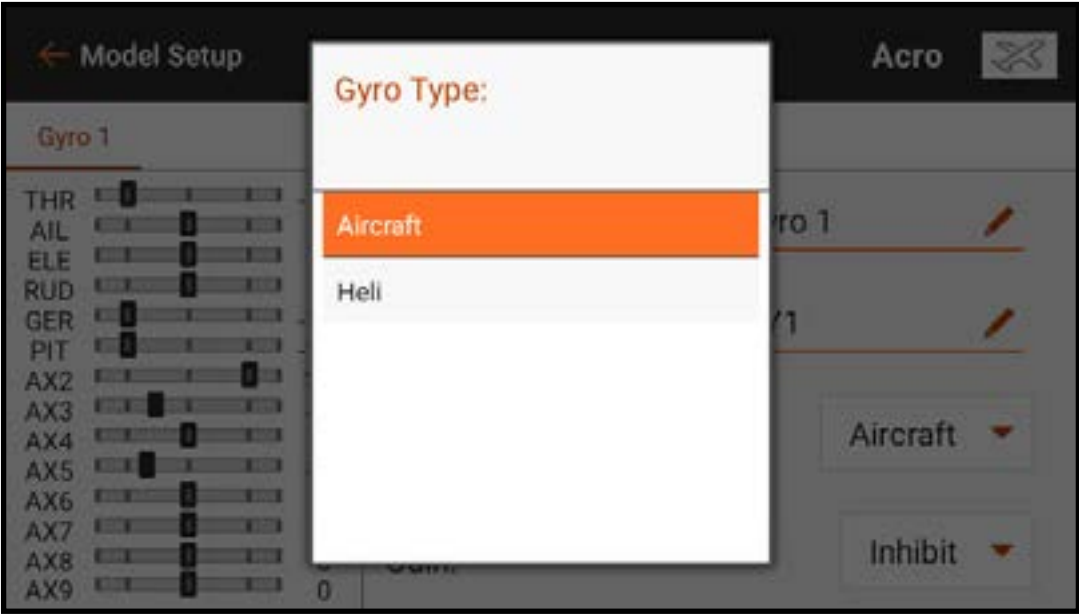

The **Heli** gyro type is used when a helicopter style heading hold gyro control input method is used. For these curves the numbers range from -100 to 100. This is normally used to provide two functions (rate or heading hold). Selecting a positive or negative number defines the mode as heading hold or rate mode. The value serves as the gain setting for tuning the gyro response. For example, in heli gyro mode -50 and 50 are both 50 percent gain, but one will be heading hold and one will be rate mode. Gyro features vary between products, so consult the gyro manual for more information.

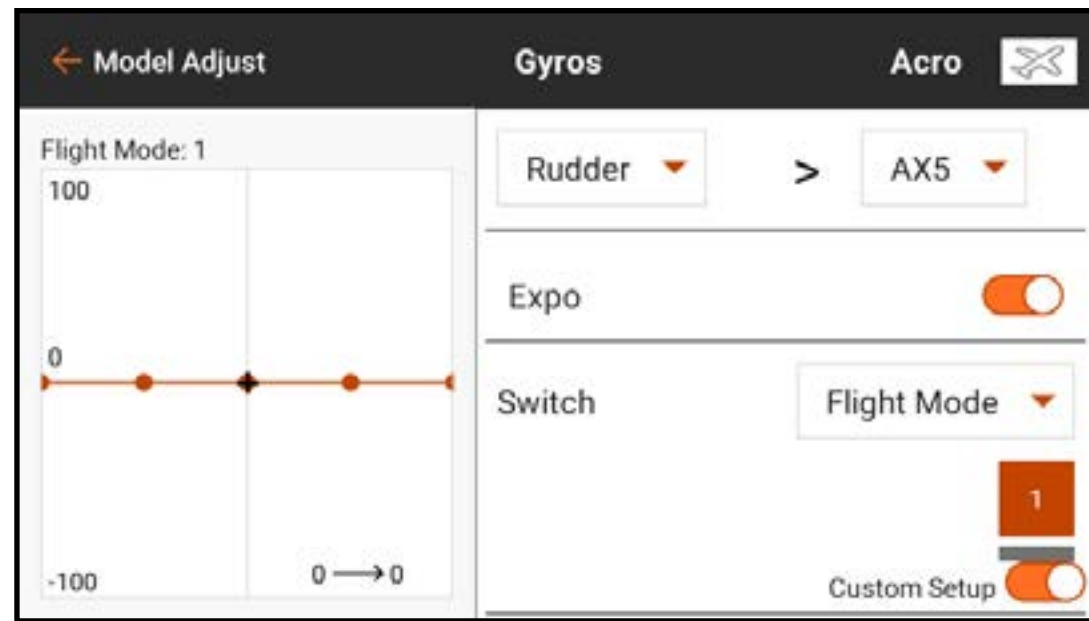

The **Aircraft** type is intended for use with certain rate-mode-only airplane gyros that read the full signal range of zero to 100. This selection will change how the curve is laid out in the **CURVE** sub menu.

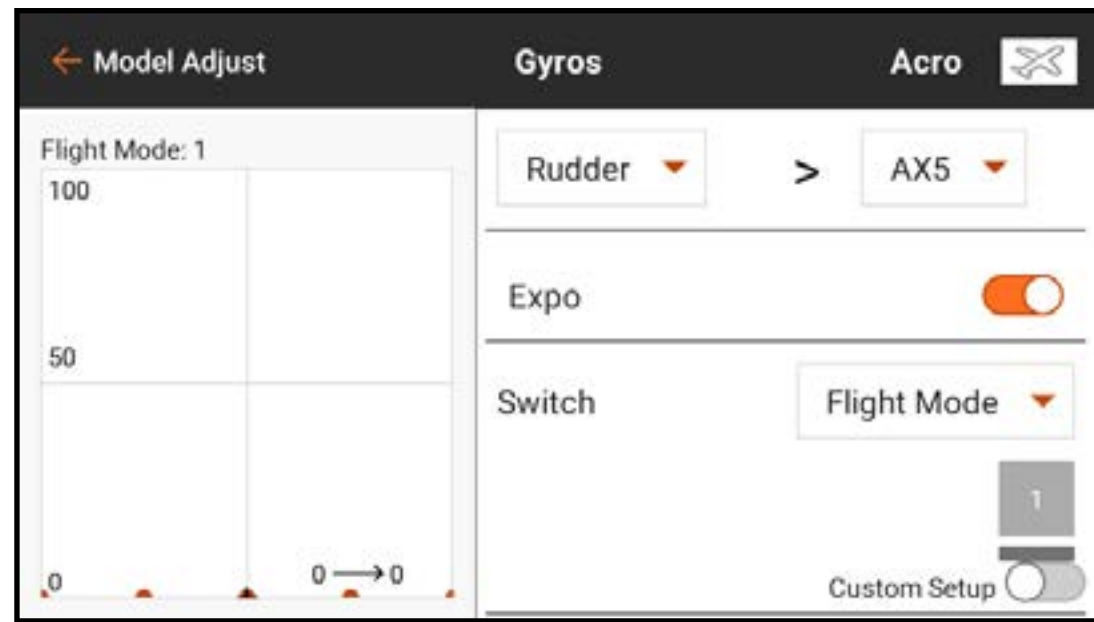

To program an ACRO, aircraft type gyro:

1. Touch **CURVE** to open the custom curve mix.
2. Assign the input channel for the gyro. For example, if the gyro is installed to assist the aileron channel, select **Aileron**.
3. Assign the output channel for the gyro, for example, the Gear channel. The gain signal from the gyro must be plugged into the designated port to function properly; in this case, the gear port.
4. Add the desired gyro gain values to the points on the curve.
5. To add more points on the curve, move the master control input to the desired location for the new point on the curve, and touch the **Add Pt** button.
6. Assign the switch positions to activate the gyro curve. The curve is active when the box is solid.



Pilots will often set the value in the center of the curve at a high gain value. The gain is usually reduced to zero with full input at both ends of the travel. As the input is moved the gain is quickly reduced. This way the gyro provides stability at center stick and corrects less when the pilot makes control inputs. This concept helps gyro corrections feel more natural and less robotic.

Assign curves for each flight mode and each gyro axis.

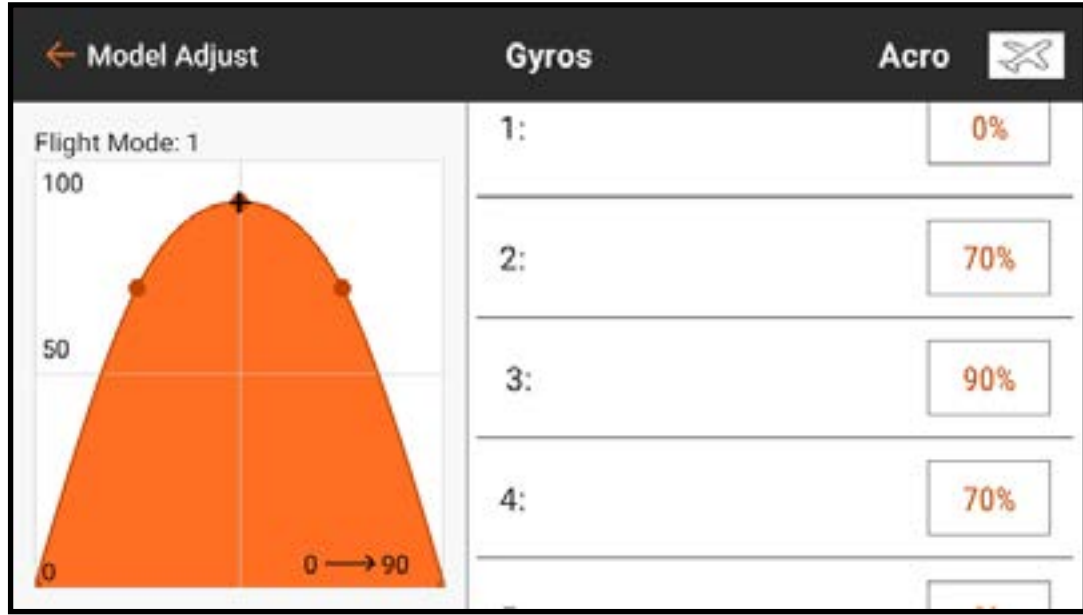

# GOVERNOR

The Governor menu is available when the model type is set to Helicopter. Governors and rev limiters attempt to manage the rotor speed of the helicopter. How the governors function can vary greatly. Consult the governor manual for more information.

- Some governors dictate head speed using the throttle signal exclusively. This is fairly common for electric helicopters. The Governor menu is not necessary for these configurations. The throttle curves and flight modes will deliver the features necessary.

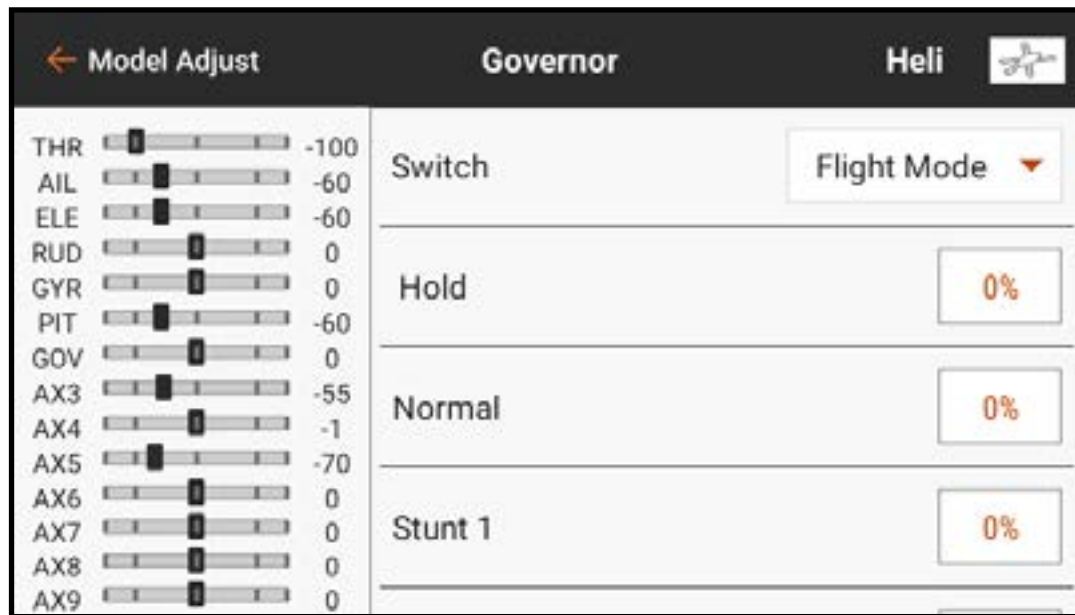

- Other governors dictate head speed using the throttle signal and a flight mode or gain signal. The Governor menu manages this gain signal. Select the gain channel and each flight mode (stunt mode) will have a value that can be assigned to the gain channel.

# TAIL CURVE

Helicopters without a heading hold gyro will experience inconsistent tail performance. When throttle is applied, the tail will swing one way and then another with reduced power. Tail curves are used to compensate for torque at various points in the throttle range. Tail curves are commonly tied to flight modes and tuned to match each mode after the pitch and throttle curves are set. The tail curve mix is not required with most modern helicopter flight control systems.

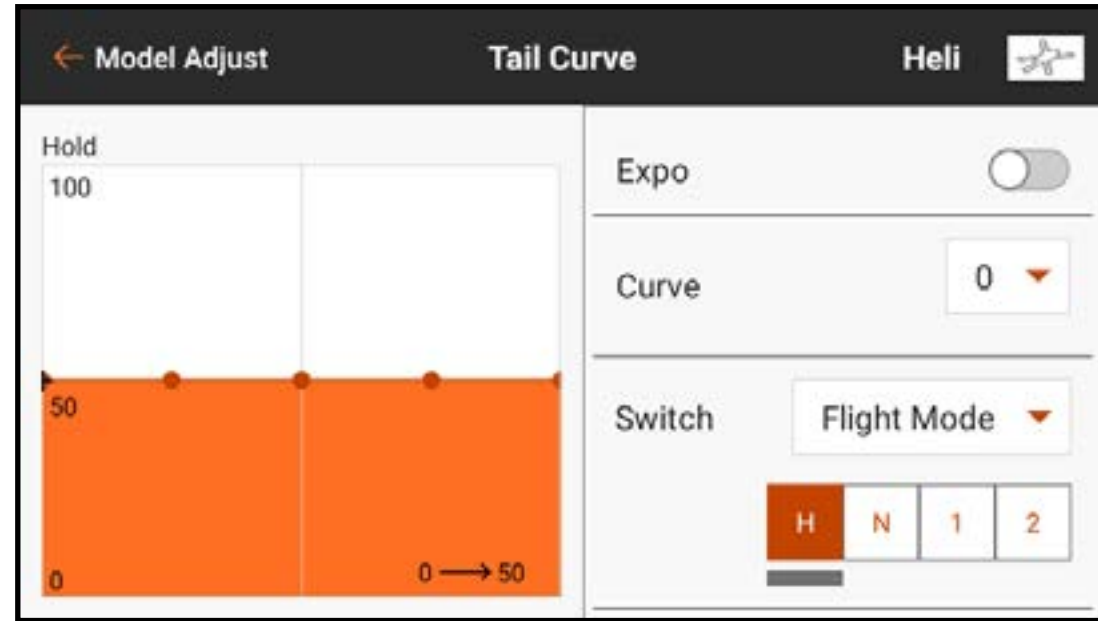

# CAMBER PRESET

The Camber Preset menu is activated when the model type is set to Sailplane and when one of the multi-servo wing types is selected in Sailplane Type in the Model Setup menu. The Camber Preset function allows for programming of the ailerons, flaps (if assigned), wing tips (if assigned) and elevator for a specific position in each flight mode. If flight modes are not active, only one preset position is available and is always active.

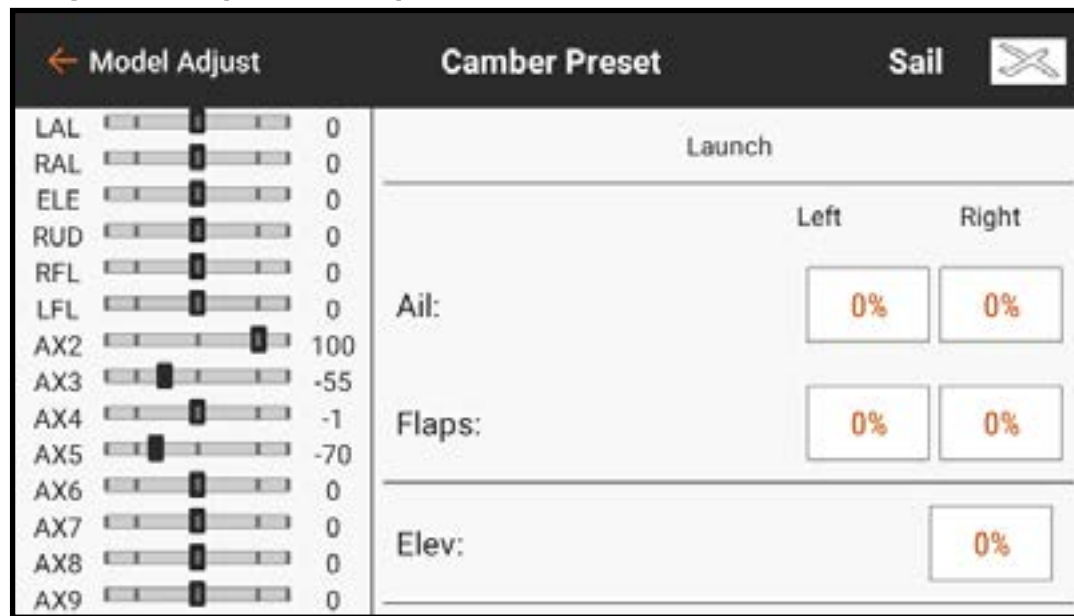

Move the flight mode switch to the desired position to change the camber preset values.

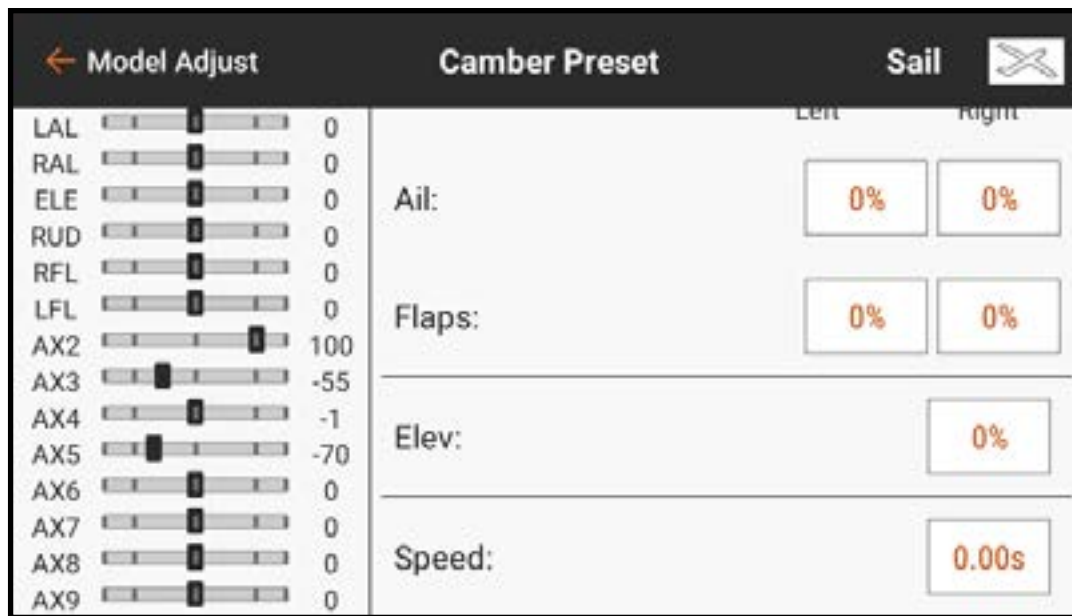

The **Speed** setting enables the control surfaces to transition over a period of time, up to 120 seconds, when the flight mode is changed.

## CAMBER SYSTEM

The Camber System menu is activated when the model type is set to Sailplane and when one of the multi-servo aileron wing types is selected in Sailplane Type in the Model Setup menu. The Camber System allows camber adjustment in flight and is used as the braking system. Each flight mode can have the camber system assigned differently and can use different input controls for each. Pilots often use the spoiler stick to manage lift with precision, deploying camber in a manageable way to slow the sailplane while maintaining effective control authority to prevent the aircraft from stalling.

## IN-FLIGHT CAMBER CONTROL

Each flight mode can have an independent configuration with different offsets and travel. Some flight modes may have a small range of camber (drooped trailing edge), while others may have a small range of reflex (raised trailing edge). Common practice is to have some flight modes utilize a small amount of travel for fine trailing edge control and some flight modes to use a large amount of travel to act as flaps.

## IN-FLIGHT BRAKING

In-flight braking requires simultaneous flap and aileron deployment in order to create drag and slow the aircraft. These complicated mixing functions are often referred to as Crow or Butterfly. Crow is a flight mode where the flaps deploy and the ailerons reflex upward. The sailplane is put into a steep dive before crow is deployed, and even the fastest, most streamlined sailplanes can be landed slowly, with precision.

To achieve crow functionality, the pre-configured flap-to-aileron mix is used to raise the ailerons when the flaps deploy. Ensure the mix is configured correctly. See the Mixing, Back Mixing section for more information.



For example, a basic 3 flight mode setup on an electric sailplane with a 4 servo wing may be configured so that:

- **In launch mode:**

The spoiler stick operates the motor as a throttle stick for the motor.

Camber is controlled from a slider and is mixed to ailerons so the flaps and ailerons work together as flaps.

The range of the camber movement is limited from neutral to a few degrees of camber.

- **In cruise mode:**

The motor is disabled using the Motor Cut menu set to the flight mode.

The spoiler stick controls the camber.

- The flaps are mixed to the ailerons so they act together.
- The camber is neutral at center stick.
- At high stick, a few degrees of reflex is produced to increase speed when sink is encountered.
- Low stick produces moderate camber to manage lift.

In this mode aileron to flap mixing delivers full span ailerons, and elevator to flap mixing makes elevator response aggressive.

- **In land mode:**

The motor is disabled using the motor cut menu.

The spoiler stick deploys crow.

- At high stick the camber is neutral.

- As the stick is moved down, the flaps are dropped and the ailerons are reflexed up.

- A flap to elevator mix provides down elevator as the crow is applied to compensate for pitch changes.

- At low stick the flaps may be nearly 90 degrees and the ailerons are fully raised.

# CAMBER SYSTEM PROGRAMMING

To program the Camber System:

1. Configure all of the flight modes before beginning the camber system programming.
2. Touch **Camber System** from the Model Adjust menu.
3. Select the flight mode to program. Moving the flight mode switch changes the flight mode indicated at the top of the menu.

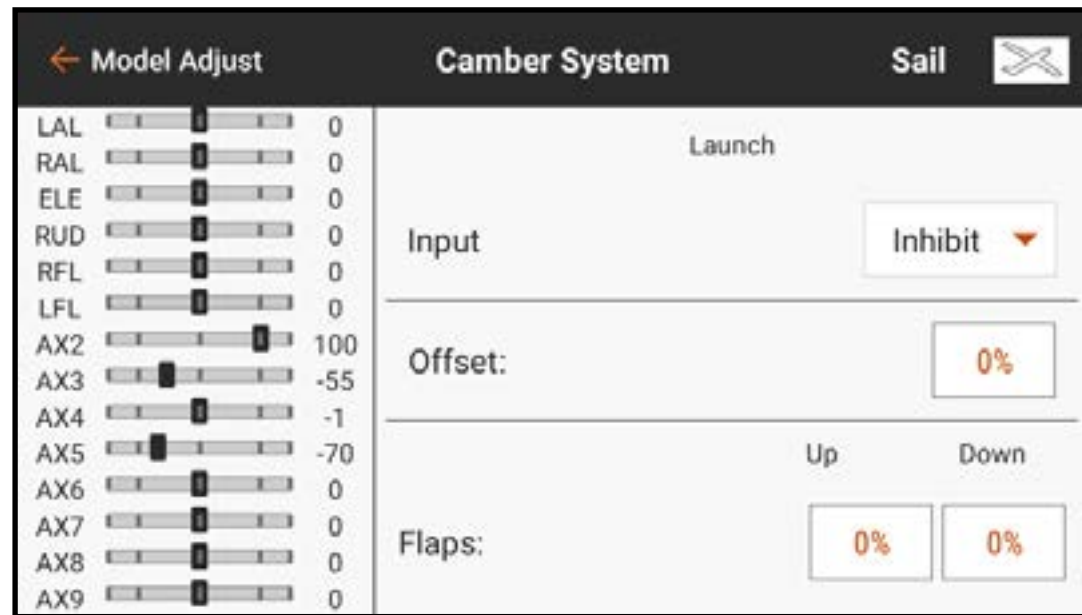

4. Select an Input for the selected flight mode.
5. Set an Offset value if desired. Offset may be required to compensate for the geometry of sailplane flap servos.

6. Set the Up and Down values for the control surfaces.

The up value defines the upper side of the surface travel.

The down value defines the lower end of the surface travel.

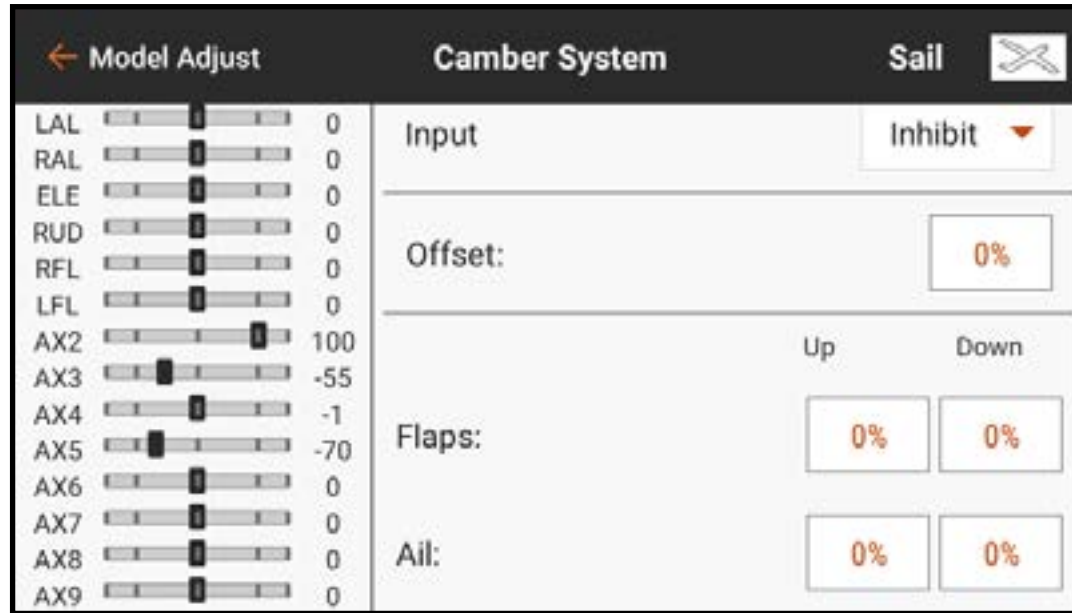

7. Select the next flight mode and program it according to Steps 4–6 until all flight modes are programmed.

# MODEL SETUP

The Model Setup menu features are used for basic aircraft setup configuration. The menu list varies by model type.

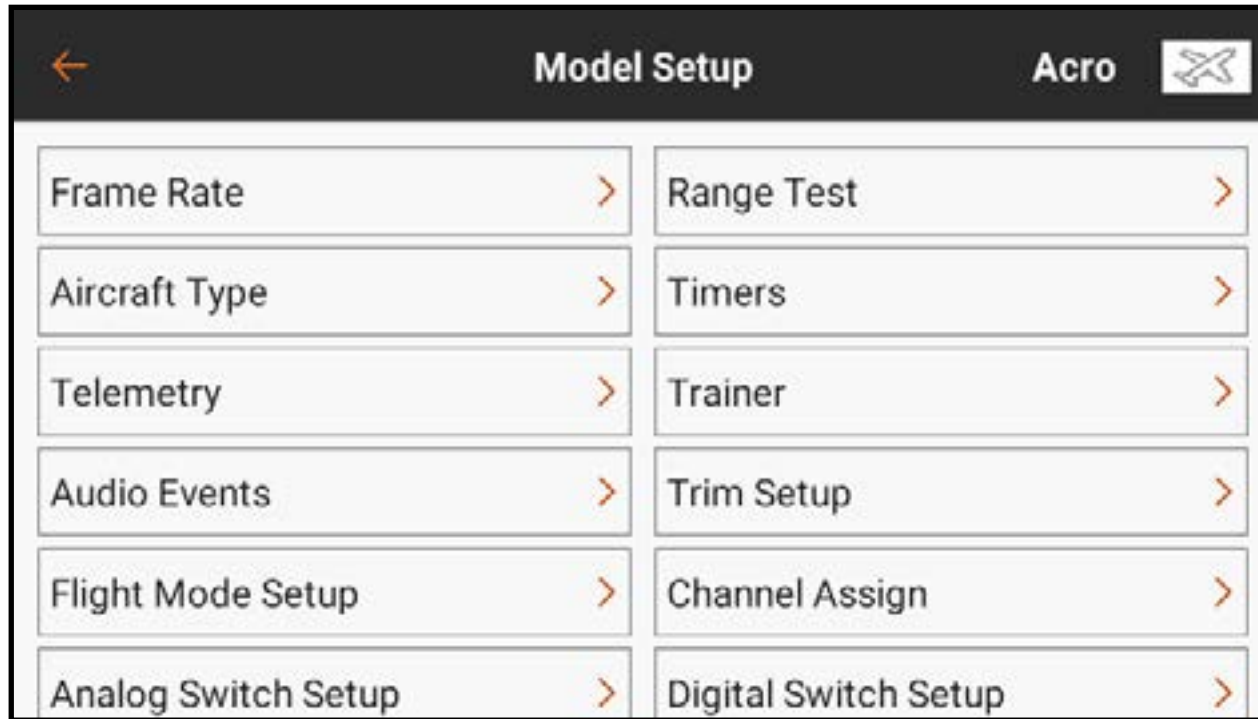

The Model setup menu list includes:

- Frame Rate
- Aircraft Type (ACRO, MULTI)
- Swash Plate Type (HELI)
- Sailplane Type (SAILPLANE)
- Telemetry
- Audio Events
- Trim/Channel Config (MULTI)
- Flight Mode Setup
- Analog Switch Setup
- Combo Switch Setup
- Logical Switch Setup
- Model Start Warnings
- Menu Setup
- Sleep Mode
- Range Test
- Timers
- Trainer
- Trim Setup
- Channel Assign
- Digital Switch Setup
- Serial Port Setup
- Bind

# BIND

Binding is the process of linking the iX14 to an aircraft receiver. The iX14 is compatible with genuine DSM2<sup>®</sup> and DSMX<sup>®</sup> Spektrum receiver products. Access the Bind menu from the Model Setup menu or access it directly by touching the **BIND** button on the Dashboard screen.

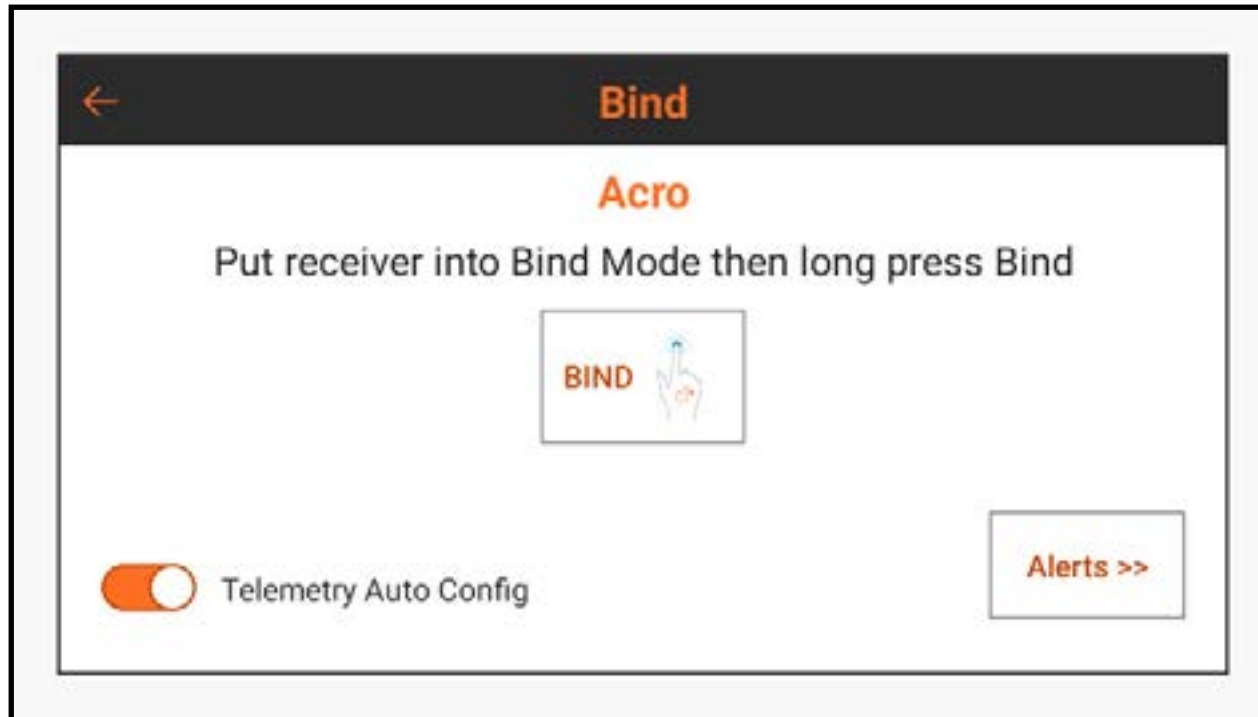

Touch **Alerts** to configure any alerts that occur during binding.

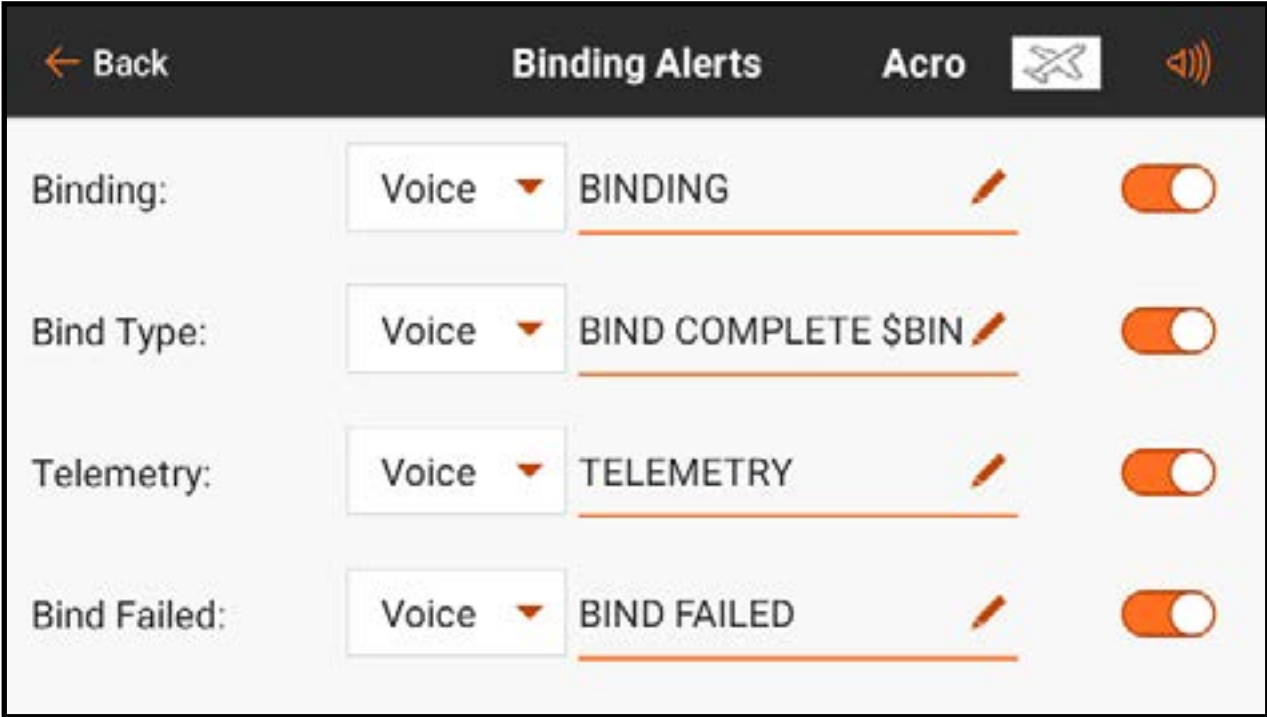



# TIMERS

The Timers menu offers two configurable on-screen timers and the integrated timers along the ribbon at the top of the screen. Each model type has its own default timer assignment. See the Model Type Defaults section for more information.

Timers 1 and 2 are independent from each other and are freely assignable. Each timer can be activated and configured or disabled.

The screenshot shows the 'Timers' configuration screen. At the top, there is a navigation bar with a back arrow, 'Model Setup', the title 'Timers', 'Acro', and a logo. Below the navigation bar, there are three tabs: 'Timer 1' (selected), 'Timer 2', and 'Integrated'. The main content area is divided into four sections:

- Enabled:** A toggle switch is currently turned on (orange).
- Timer Name:** The name is 'Timer 1', with an edit icon (pencil) to the right.
- Display:** A dropdown menu is set to 'Timer'.
- Mode:** Two radio buttons are present: 'Stopwatch' (unselected) and 'Countdown' (selected).

The integrated timers record the time the model has clocked as well as the total time the iX14 system has clocked. Reset them by selecting the **RESET** button.

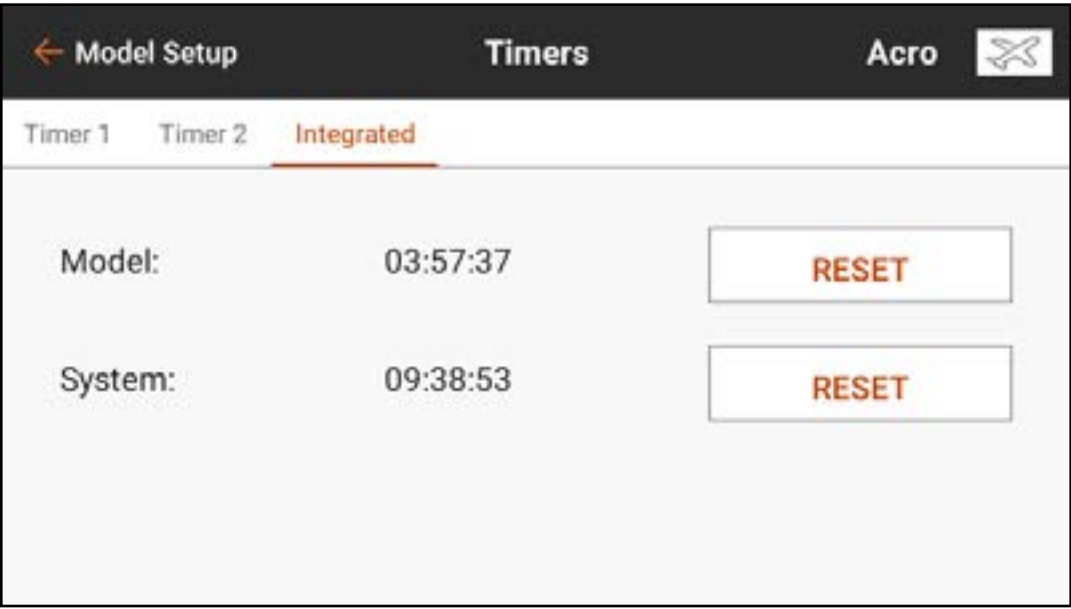

To configure a timer:

1. From Model Setup, touch **Timers**.
2. Touch **TIMER 1** or **2** along the top ribbon. Menu options for these two timers are identical.
3. Set the **Enabled** button to on to enable the selected timer.
4. Name the timer if desired.
5. Touch the **Display** selection box to choose between the timer or a telemetry item on the main screen. If you select **Telemetry Item**, select from the drop down box to find the desired telemetry item to display in that timer slot on the main screen.

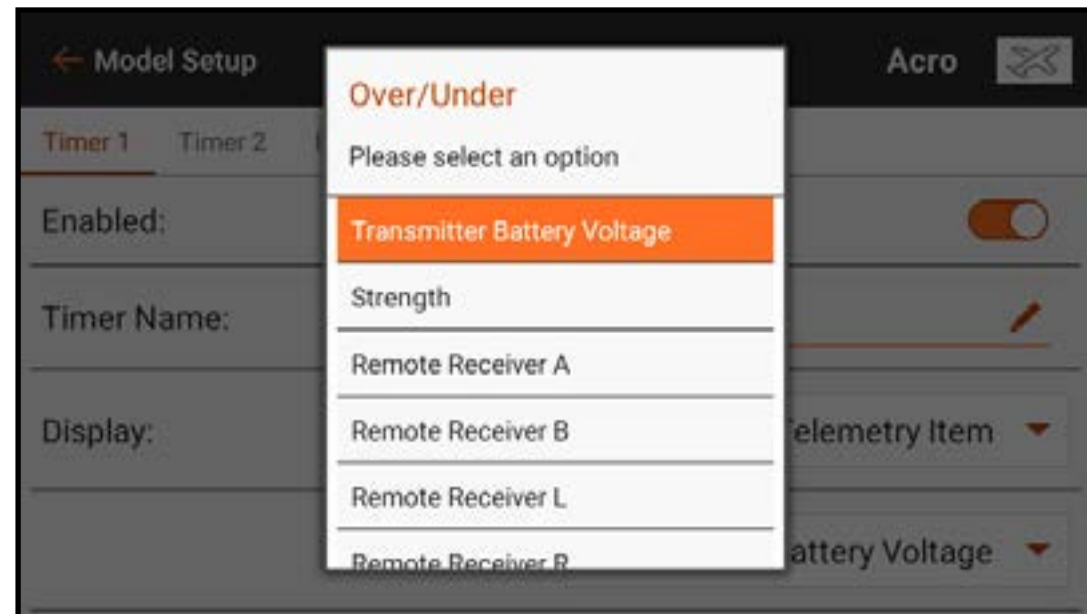

6. If you selected **Timer** in the previous step, select **Stopwatch** or **Countdown**.

**Stopwatch:** counts up from zero at start.

**Countdown:** counts down from a user defined time at start.

7. If Countdown is selected, the start time (Minutes and Seconds) can be changed.

The default setting is 5 minutes.

8. Touch the **Switch** selection button.

If an analog input device is selected, touch the **Over Under** selection button.

Over Under defines if the timer is running when the input device is over or under the **Trigger** value. Touch

the Trigger selection button to set the trigger value. For example, Throttle

Stick is the default switch for Acro and is set to trigger when the throttle is over 25%. Moving throttle below 25% will stop the timer.

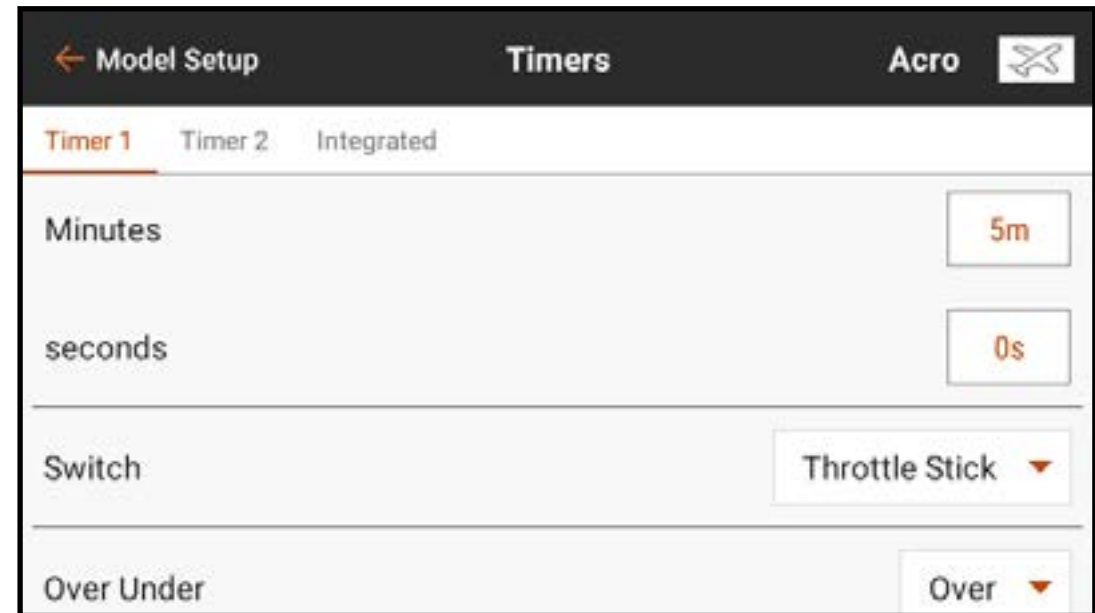

9. **One Time** can be selected if the timer continues counting once started, regardless of the input.
10. Touch the **Timer Alerts** button to set audio and vibration alerts.

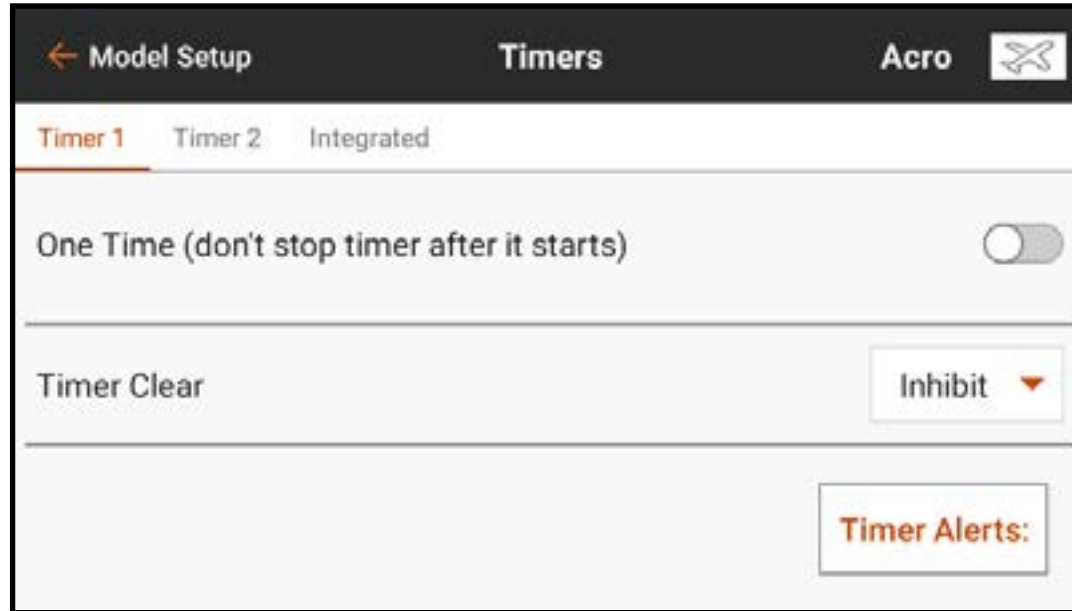

**Timer Control Alerts:** Announce when the timer starts, stops, or resets.  
**Alerts:** Can be set to report at timed intervals. These alerts are pre-configured with Macros for basic text-to-speech reporting. The spoken alerts can be changed at these trigger points by changing the text. See the **Audio Events** section for more information on changing spoken text and using Macros.

← Timer Alerts: Acro ✈

**Timer Control Alerts**

Timer Start:	Voice ▾	Timer Start	✎
Timer Stop:	Voice ▾	Timer Stop	✎
Timer Reset:	Voice ▾	Timer Reset	✎

---

**Alerts:**

Every Minute (Down):	Voice ▾	Time Remaining \$TIMER1_MIN	✎
----------------------	---------	-----------------------------	---

**TIP:** Touch one of the clock icons (🕒) in the Timer displays on the Dashboard screen to directly access the Timers menu. Press and hold the Dashboard timer display to reset the timer.

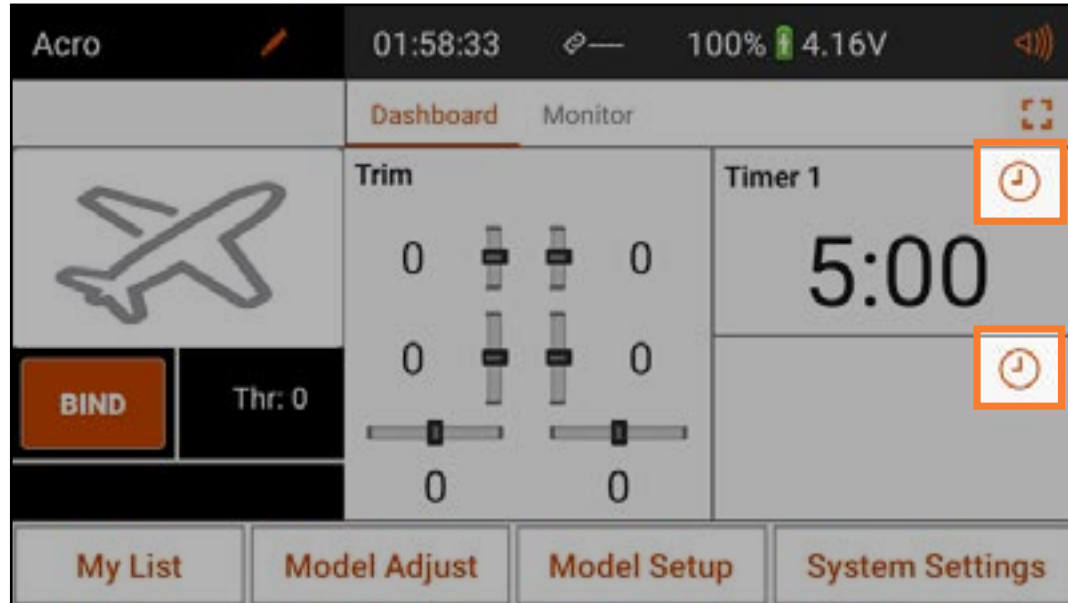

# FRAME RATE

The Frame Rate menu gives options for frame rates and DSM type.

**RF Mode:** Options include Automatic and Force DSM2.

DSM2 may be used with DSM2 only receivers. DSM2<sup>®</sup> technology is not available in the European version of the iX14.



**CAUTION:** Never fly in an area with more than 40 active 2.4GHz transmitters while using DSM2 technology.

← Model Setup Frame Rate Acro 

RF Mode: Automatic ▾

Servo Mode: Default 22ms ▾

DX18 Compatibility: off

THR: 22 ms	AX1: 22 ms	AX6: 22 ms
AIL: 22 ms	AX2: 22 ms	AX7: 22 ms
ELE: 22 ms	AX3: 22 ms	AX8: Var
RUD: 22 ms	AX4: 22 ms	AX9: Var
GER: 22 ms	AX5: 22 ms	



**Servo Mode:** Options are Default 22ms, Hybrid 11/22ms, or 14 Channel 22ms.

- Always use 22ms when using analog servos.
- When bound to a 14CH mode capable receiver, a 14CH mode option is available which offers 14 channels at 22ms.
- 11ms settings require digital servos or direct communication with the Spektrum serial signal (e.g., a flight controller).

**DX18 Compatibility:** Enable this option if the model file was created on or will be used by a DX18 transmitter. This changes the transmitter channel mapping to the unique configuration of the DX18.

# SPEKTRUM TELEMETRY

Telemetry options on the iX14 require compatible telemetry devices. Some telemetry devices offer limited telemetry options. DSMX Ultra Micro Aircraft will report RF performance, but do not have further telemetry options.

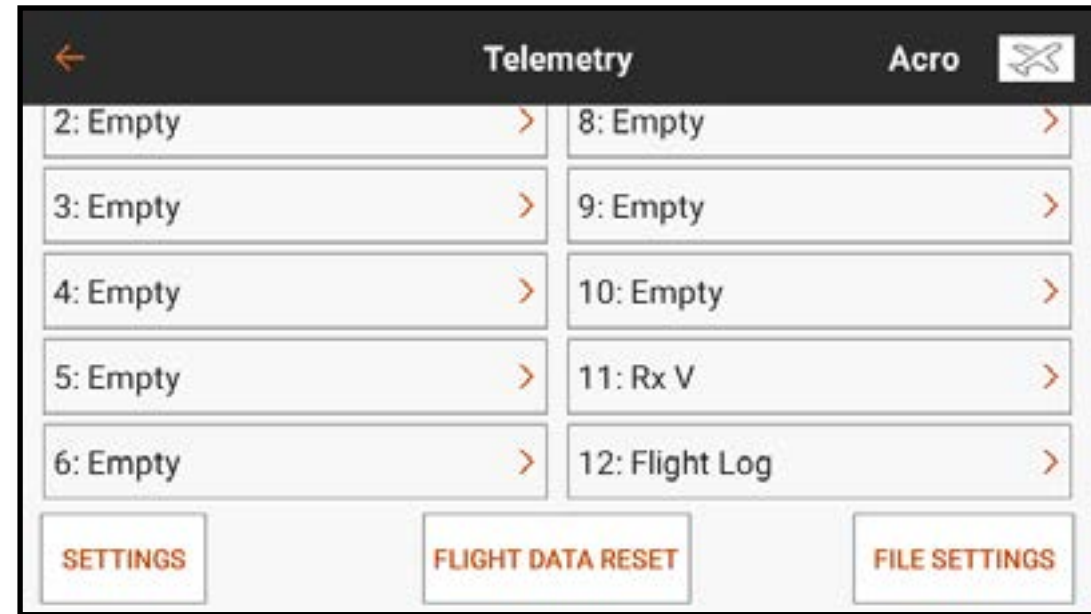
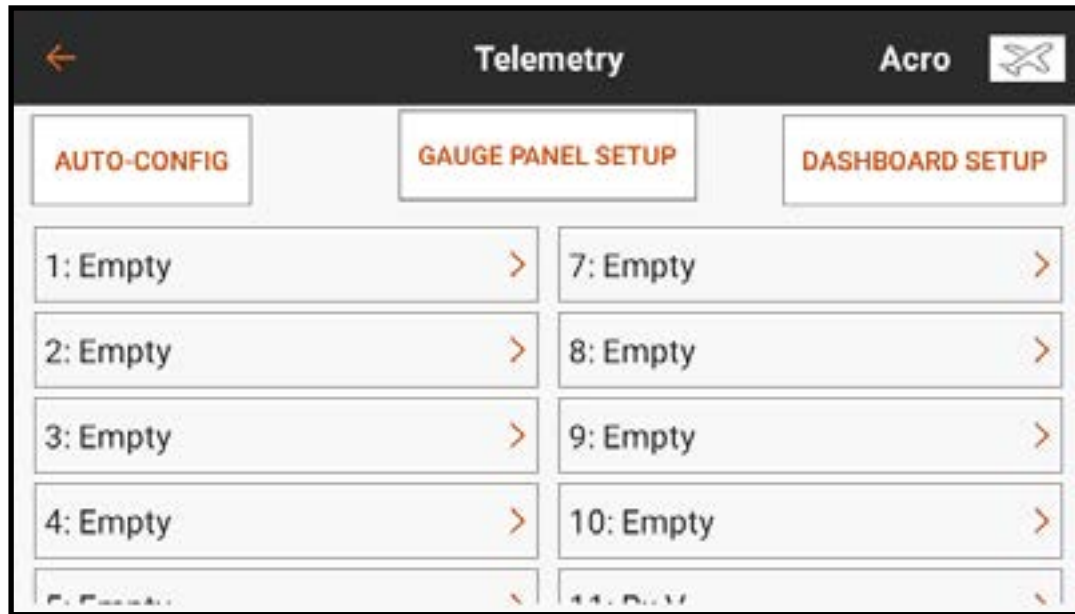

## AUTO-CONFIGURING TELEMETRY AT BINDING

During bind, an option appears on the **Bind** screen to activate or disable the telemetry auto-configuration feature. When activated, after a successful bind, the system performs the auto-configuration automatically and pre-sets any values available, including activation of Smart Battery and Smart ESC if present, pre-configure low voltage warning for the ESC and pre-configure start up warnings if an uncharged battery is connected (only available with Spektrum Smart ESCs, Batteries and compatible receivers).



## USING SPEKTRUM TELEMETRY

Let the iX14 automatically configure the telemetry sensors from the Telemetry menu, or set up each sensor manually. Receiver voltage always defaults to slot eleven, and flight log data to slot twelve.

To configure the telemetry system:

1. Install and connect the telemetry sensors to a compatible Spektrum telemetry receiver or module according to the instructions included with the sensors and receiver/module.
2. Bind the receiver to the iX14. The Bind menu includes an option to auto-configure the telemetry. For more information, see the **Auto-Configuring Telemetry At Binding** section.

3. Configure the connected sensors.

**To let the iX14 determine the connected sensors:** Touch the Auto-Config button. The model must be bound, powered on and all sensors connected.

**To manually enter the connected sensors:** Select the desired telemetry slot. Select the relevant sensor from the popup, scrollable list. After selecting a sensor, the sub-menu for that sensor will open.

4. Select the warning trigger thresholds and define the voice alerts and the frequency the warnings will announce.

5. Select **Remove** to delete the selected sensor from the telemetry list.

6. Select **Cancel** to ignore changes made in the sub-menu.

7. Select **Save** to keep the changes and exit back to the telemetry menu.

8. Select **Dashboard Setup** to define which telemetry data appear in the Dashboard telemetry display. Access the telemetry display screen by swiping from the Dashboard.

# TELEMETRY SCREEN CONFIGURATION

**Gauge Panel Setup:** Touch the Gauge Panel button at the top of the Telemetry list to modify the gauge display.

1. Touch the **+** to add a new panel.
2. Touch the (**>**) to open the panel configuration menu.
3. Select a layout and touch the **+** to add an active telemetry sensor.

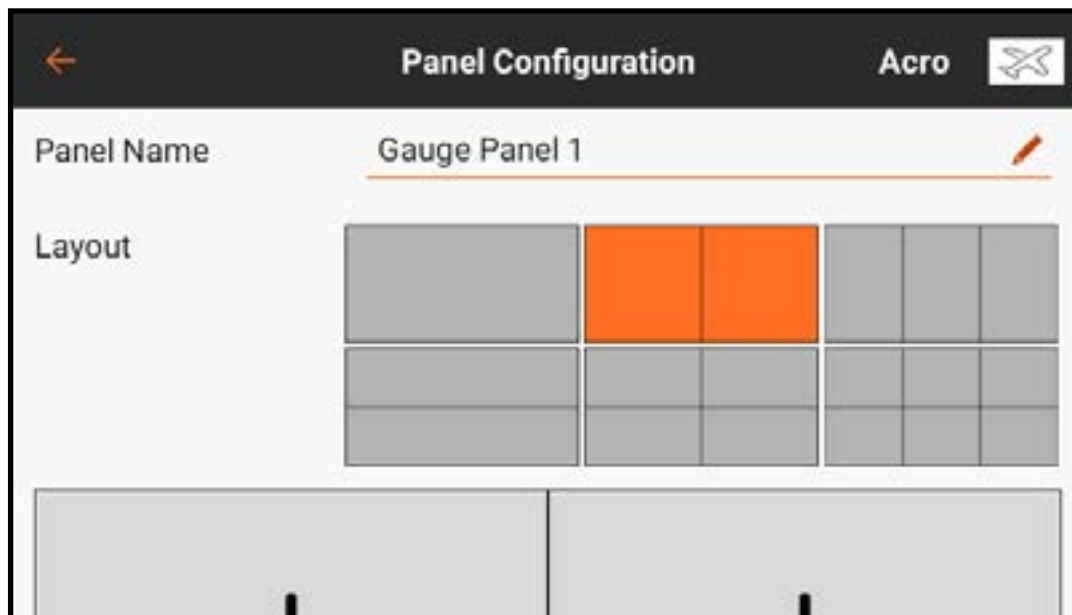

**Dashboard Setup:** Touch the Dashboard Setup button at the top of the telemetry list to modify the telemetry dashboard display.

1. Select the current panel or touch the **+** to add a new panel.
2. Touch the ( **>** ) to open the panel configuration menu.

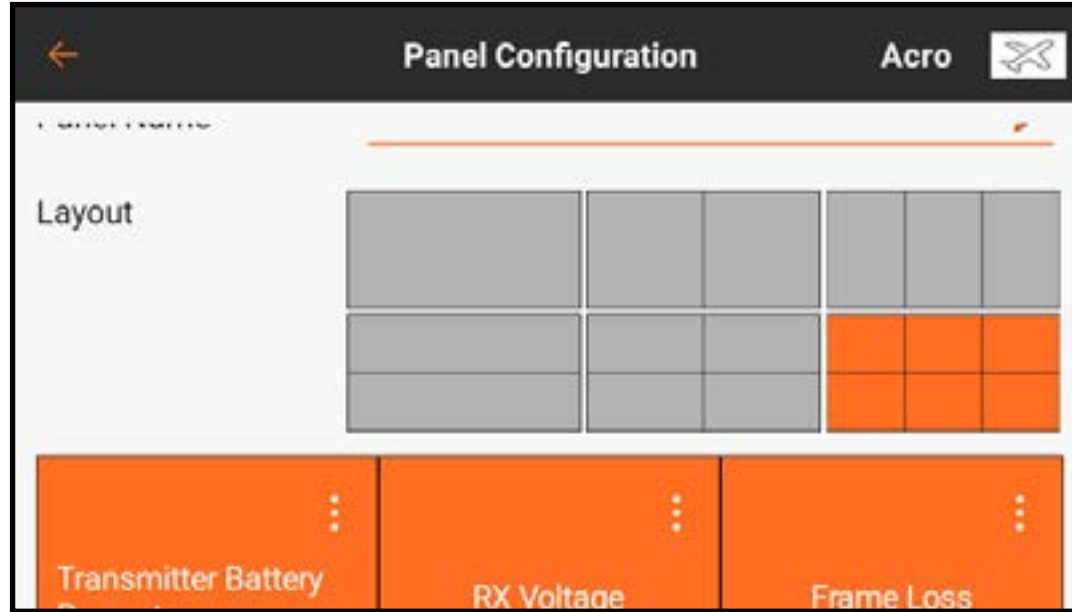

3. Select a layout. Any active sensors will show up in the bottom display.
4. Touch the expand button ( **⋮** ) in any of the active sensors to modify the settings or touch the **+** to add a sensor to any open slots in the selected layout.

## TELEMETRY SENSORS

A variety of Spektrum telemetry sensors are available. These can be connected to any compatible telemetry device. X-Bus sensors can be daisy-chained to connect multiple sensors to the X-Bus port of the aircraft receiver or telemetry module.



## ANALOG SWITCH SETUP

The Analog Switch Setup menu allows all sticks, sliders and knobs (analog input devices using potentiometers) to be used as a kickpoint to activate functions like mixes or dual rates.

Each input has two kickpoints between -100% to 100%. This range represents the full travel, with 0% being center. Each section within the range of travel represents a switch “position.”

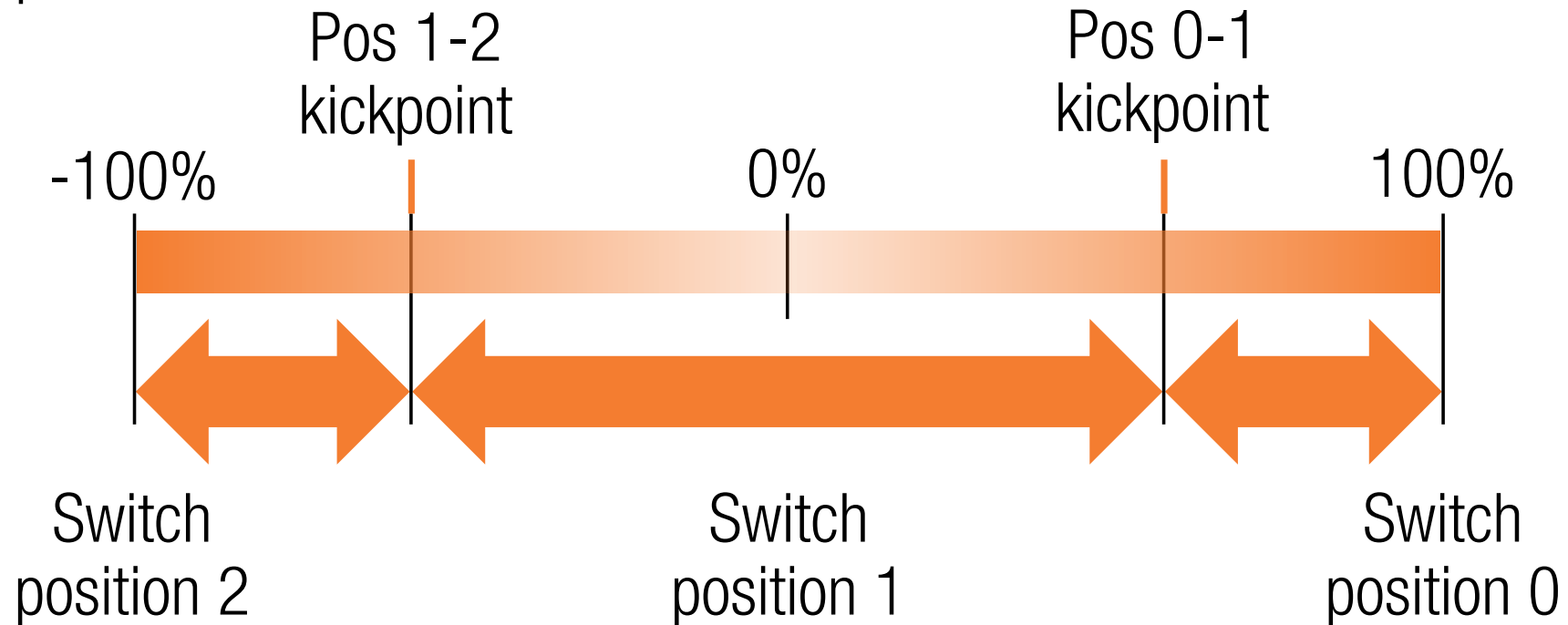

In the default state, the kickpoint for the transition between positions 0 and 1 is at 75%. The kickpoint for the transition between positions 1 and 2 is at -75%. The input is in switch position 1 at neutral (0%). Moving the input above 75% will change it to position 0, and moving it below the -75% value changes it to position 2.

Kickpoints can be assigned to any value between -100% and 100%, allowing the kickpoints to be assigned as close to or as far apart as desired. The values of the kickpoints determine where they trigger along the travel range. If the values are the same, the switch output will skip position 1 and jump between positions 0 and 2.

To program the switch kickpoints:

1. Touch either of the value boxes for the analog control.
2. Adjust the location of the kickpoints by dragging the highlighted circle or using the **+** or **-** buttons.
3. Touch **OK** to save the values, **Cancel** to exit the kickpoint adjust menu or **Reset** to return to the default settings.

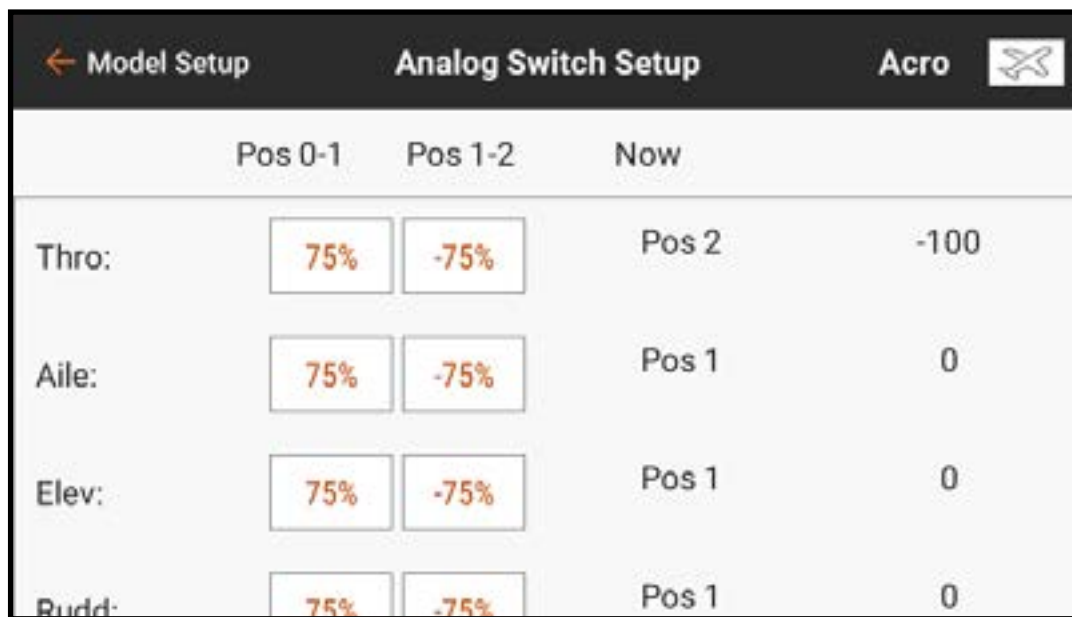

	Pos 0-1	Pos 1-2	Now	
Thro:	75%	-75%	Pos 2	-100
Aile:	75%	-75%	Pos 1	0
Elev:	75%	-75%	Pos 1	0
Rudd:	75%	-75%	Pos 1	0

# DIGITAL SWITCH SETUP

Digital Switch Setup gives flexible output options for a channel to be driven from a switch or flight mode.

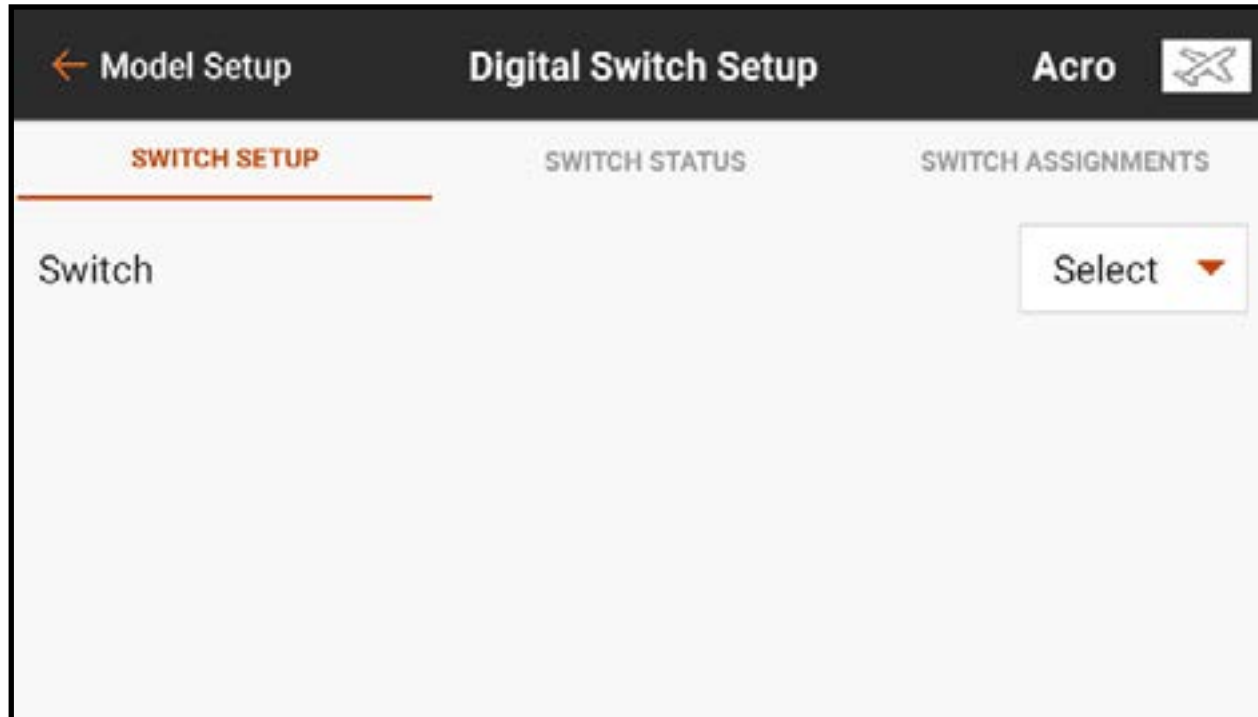

To program a Digital Switch Setup:

1. Channel assignments cannot be made from the Digital Switch Setup menu. Assign the switch or flight mode to the desired output channel in the Channel Assign menu.
2. In the Digital Switch Setup menu, touch the **Select** button to view the **Switch** menu.
3. Select the switch (or flight mode) from the list or flip the desired switch. The channel assignment is shown below the switch. If no channel is assigned to the switch the channel assignment is blank.
4. Adjust the values on the switch positions to define the output positions.

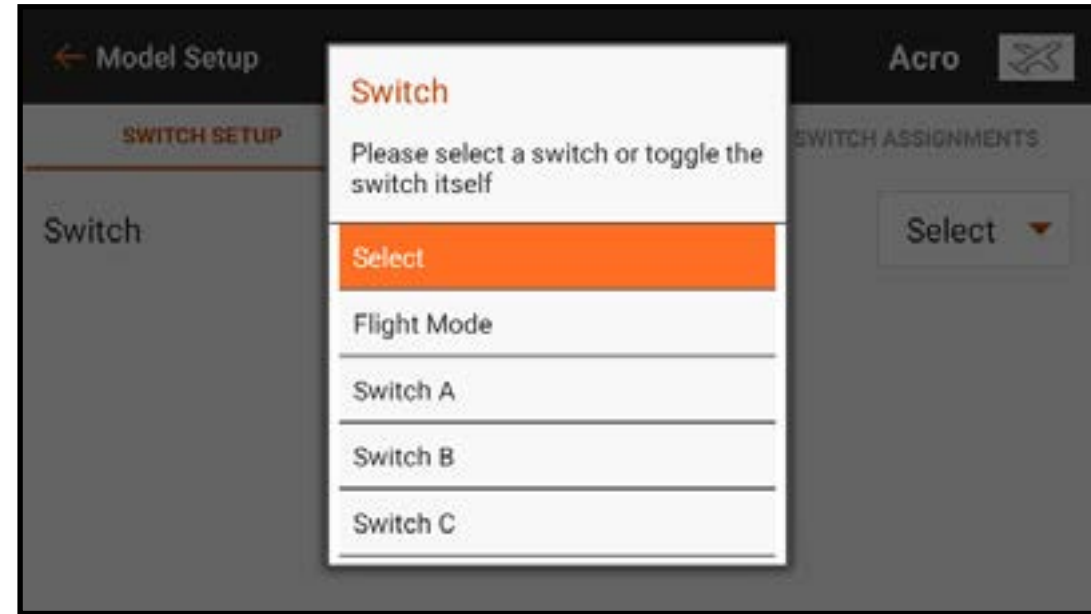

# SWITCH STATUS

Touch the Switch Status tab in the ribbon at the top of the screen to display all available switches and their positions.

SWITCH SETUP	SWITCH STATUS			SWITCH ASSIGNMENTS		
	Pos 0	Pos 1	Pos 2			
Switch A	100%	-100%				
Switch B	100%	0%	-100%			
Switch C	100%	0%	-100%			
Switch D	100%	0%	-100%			
Switch E	100%	0%	-100%			

# SWITCH ASSIGNMENTS

Touch the Switch Assignments tab in the ribbon at the top of the screen to display all available switches and their assignments.

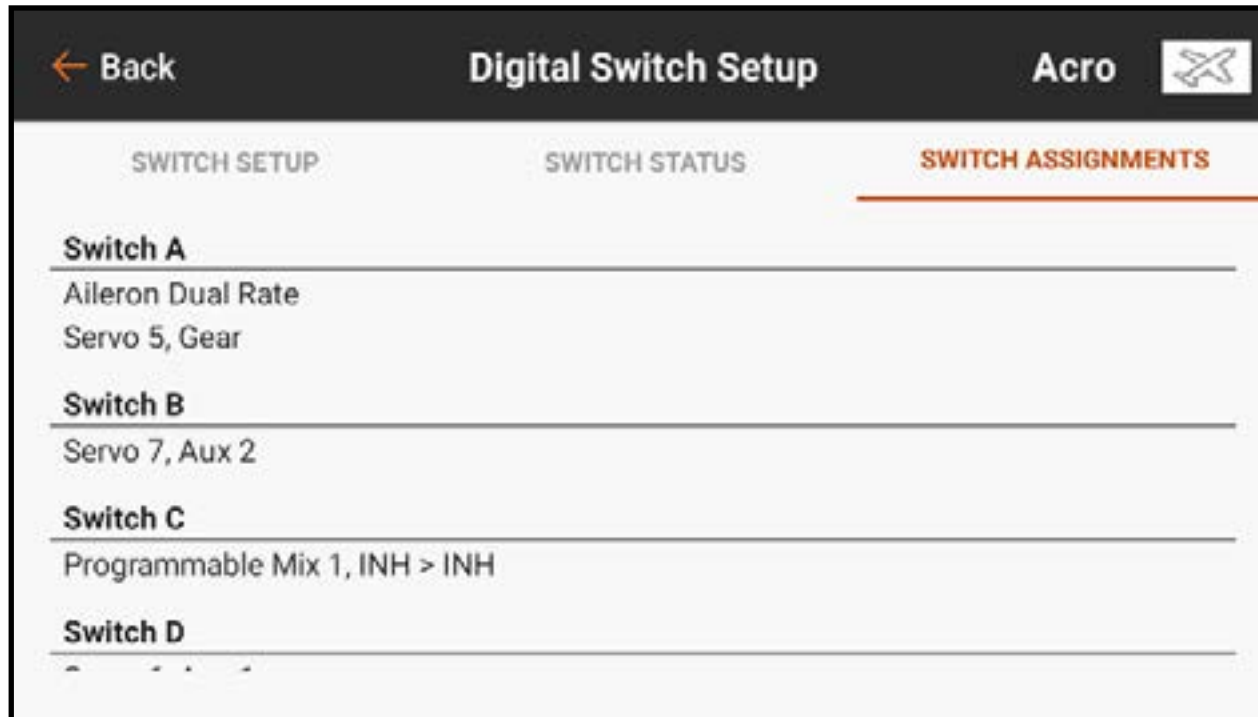

## COMBO SWITCH SETUP

The Combo Switch function allows you to control an action by either combining the use of two switches or by allowing both switches to control that action independently. From the Model Setup menu, select the Combo Switch Setup tab.

1. Touch **Select** to choose the combo switch to edit. There are up to 8 available combo switches.
2. Touch in the **Name** field to access the keyboard screen to edit the name of the combo switch.
3. Touch the box under **Switch 1** to select the first switch to use in the combo switch. Either select from the dropdown menu or move the desired switch.
4. Touch the box under **Switch 2** to select the second switch to use in the combo switch. Either select from the dropdown menu or move the desired switch.



5. With the switches chosen, the switch position boxes appear beneath each switch. Touch the position boxes to make the switch “active” or “inactive” in the given position.

- A solid box indicates an “active” switch position.
- An open box indicates an “inactive” switch position.
- The heavy grey line under the position box indicates the current position of the switch.

6. Touch the box under **Relation** to change the relationship desired between the chosen switches.

- Choosing **AND** requires both switches to be in the chosen configuration to activate.
- Choosing **OR** allows either switch to control the action, regardless of the other switch position.

The **Status** slider gives a visual indication of whether the combo switch is active or inactive. After the setup is complete, the combo switch can be chosen in the switch field of various functions in the transmitter.

## LOGICAL SWITCH SETUP

The Logical Switch function allows you to combine the function of two switches, giving a greater range of possible switch positions. The number of possible positions for a single logical switch setup will depend on which two switches are used as inputs.

From the Model Setup menu, select the Logical Switch Setup tab.

1. Touch **Select** to choose the logical switch to edit. There are up to 8 logical switches available.
2. Touch in the **Display Name** field to access the keyboard screen to edit the name of the logical switch.
3. Touch the box next to **SW 1** to select the first switch to use in the logical switch. Either select from the dropdown menu or move the desired switch.
4. Touch the box next to **SW 2** to select the second switch to use in the logical switch. Either select from the dropdown menu or move the desired switch.

5. With the switches chosen, a switch position table appears. The solid blue box in the table indicates the current active position of the logical switch.
  - Switch 1 moves the active position up and down in the table.
  - Switch 2 moves the active position left and right in the table.
6. To change the order of the numbered switch positions touch the box position you wish to change.
7. Select the numbered switch position desired from the dropdown menu, 0-9, until the position order is as desired.

After the setup is complete, the logical switch can be chosen in the switch field of various functions in the transmitter.

# SLEEP MODE

The Sleep Mode menu allows the user to change RF and screen state. Access the menu either from the Model Setup menu, or double tap the power button.

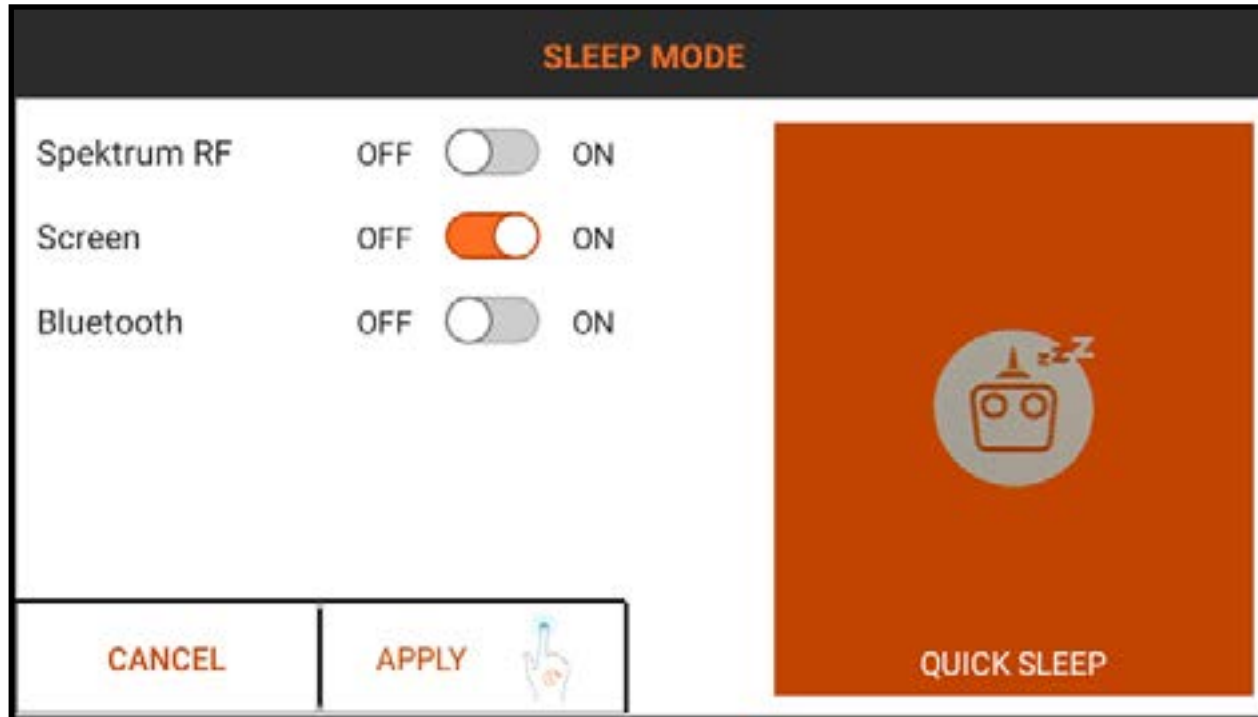

 **WARNING:** Never put the RF into sleep mode when connected to a model that is powered on. Loss of control and/or serious injury may result.

To put the transmitter or the screen in sleep mode:

1. Either double tap the **Power Button** or touch **Sleep Mode** in the Model Setup menu.
2. Touch the OFF/ON button(s) to turn off any combination of the **Spektrum RF**, **Screen** or **Bluetooth**.
3. Touch and hold **APPLY** to put the selected item(s) in sleep mode or touch **CANCEL** to return to the previous screen.

An alternative method to put both the RF and screen into sleep mode with one touch is to touch and hold **QUICK SLEEP** from the Sleep Mode menu.

When both the RF and screen are in sleep mode, the LED slowly pulses for approximately one minute to indicate the iX14 is still powered on.

To wake the iX14 from sleep mode, single-tap the **Power Button**.

## TIPS:

- Tap the Power Button once to immediately put the screen in sleep mode when the iX14 is powered on. The screen can be placed in sleep mode during flight.
- When the screen is in sleep mode, tap the Power Button once to wake it.
- Place the RF in sleep mode for extended use of the iX14 when it is not connected to a model or during charging.
- Place both the RF and the screen in sleep mode for idle times during flying sessions or during charging.

## SPEKTRUM LED INDICATOR

- A slow flashing orange Spektrum LED indicates the RF is off and the screen is in sleep mode. The operating system remains powered on and ready to wake with a single tap of the power button.
- A solid orange Spektrum LED indicates the RF is transmitting.



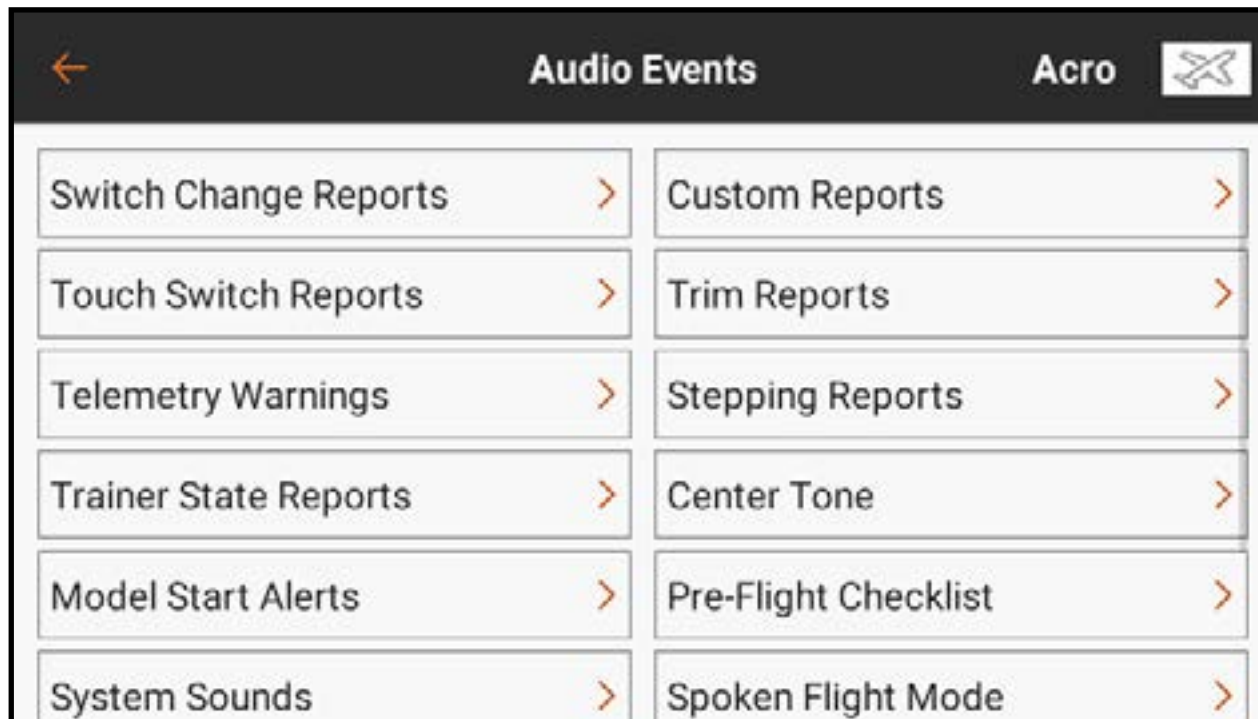

# AUDIO EVENTS

Audio Events on the iX14 can be set up to report virtually any action on the transmitter. The Audio Events menu is meant to serve as one location to find any audio report in the system. Reports can be set up based on timers, sticks, switches, telemetry data and more. The iX14 features a powerful text to speech engine in the Android operating system. Many of the options listed in this menu can be accessed from the related function menu as well.





Common menu elements:

- **Voice button:** Touch the **Voice** button to select Tone, Voice, Vibe, Tone/Vibe, Voice/Vibe or None for the audio event.
- **Spoken text editor:** Touch the line with the pen icon (  ) to edit the spoken text. Use the keyboard to make the desired changes. Alternatively, touch the microphone (  ) on the keyboard and speak the desired phrase. The Android speech-to-text function will fill in the spoken text. Touch the blue check mark (  ) in the bottom right corner to accept the changes.
- **Tone selections:** The default **Tone** audio selection sounds a “beep” report. Audio (.mp3 or .wav) files loaded to the iX14 from third party sources can be used in place of the default sound.
  1. Select one of the **Tone** options for the alert sound.
  2. Touch the pen icon (  ). A file selection menu appears.
  3. Select the directory where the sound file is located and touch **CONFIRM**.
  4. Select the file.
  5. Touch **OK**. The link to the audio file appears in the text-to-speech field.

- **MACROS:** Touch the **MACROS** button to see a list of additional spoken-text macros. Select an option in this menu to insert a text string that vocalizes the selected data. The macros include a dollar sign (\$) and description with no spaces. The macros should be set with a space on either side to function properly. Multiple macros can be used in a single line, as long as they are separated by a space. Additional spoken words can be added in front of or behind the macro, with space in between, for the desired effect.



# SWITCH CHANGE REPORTS

The Switch Change Reports menu creates an audio report when a switch is moved. Press the plus ( + ) to add a report. The on-screen switch will enable or disable the report. Touching the ( ⊗ ) will delete the report. Touch the ( > ) to open a submenu to configure the report. Select the **Switch** from the popup menu. Create the audio report for each switch position by adding text and/or macros to the text input line.

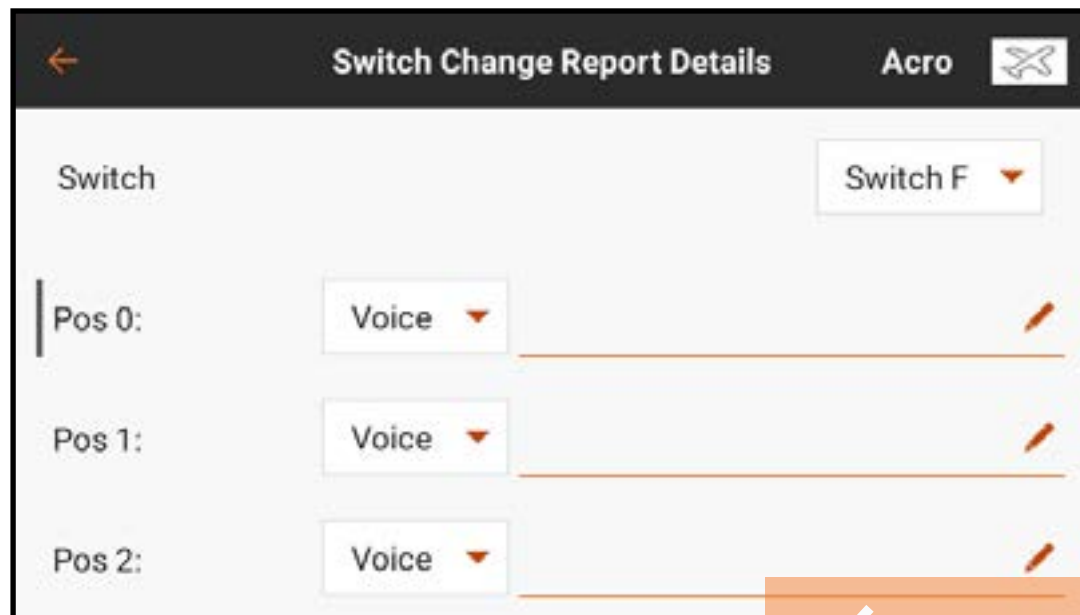
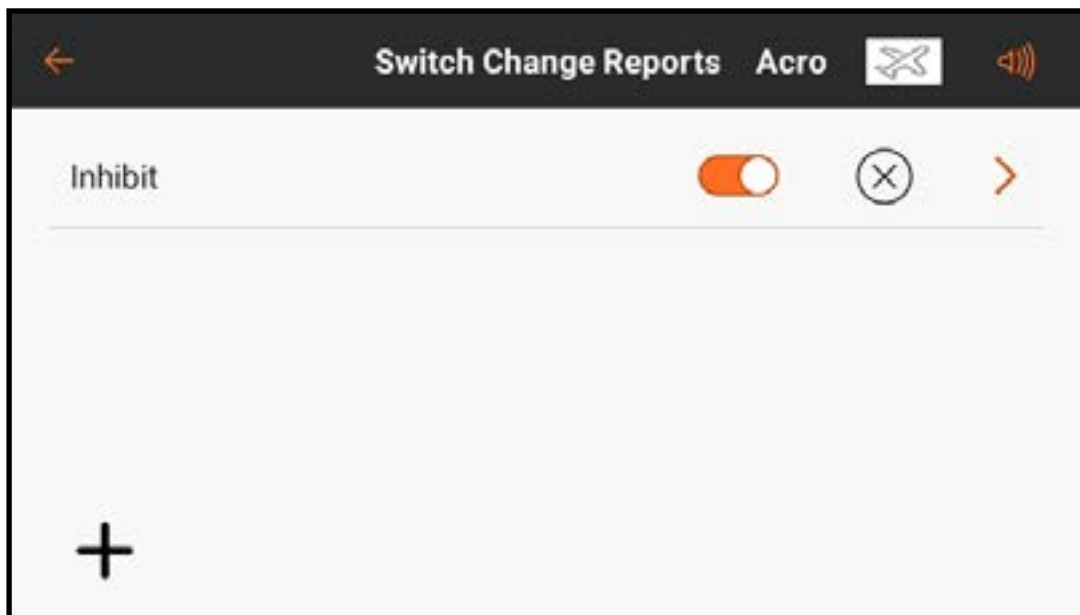

# CUSTOM REPORTS

The Custom Reports menu creates an audio event that can be set to repeat on a user-defined interval. The time selected in **Frequency** will determine how long the system will pause before repeating the report.

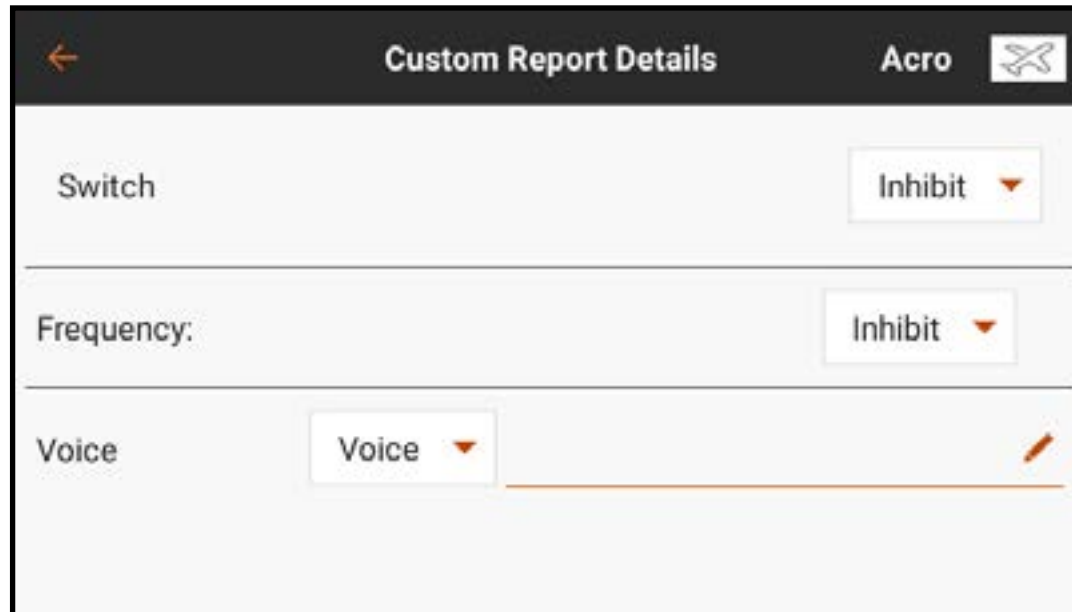

The screenshot shows a mobile application interface titled "Custom Report Details". At the top right, there is a "Acro" label and a small airplane icon. The main content area is divided into three sections by horizontal lines:



- Switch:** A dropdown menu on the right is set to "Inhibit".
- Frequency:** A dropdown menu on the right is set to "Inhibit".
- Voice:** A dropdown menu is set to "Voice", followed by a horizontal line with a pencil icon on the right, indicating a selection or editing option.

## TOUCH SWITCH REPORTS

The Touch Switch Reports menu creates audio events that are assigned to any of the toggle switches, A-H, on the transmitter. The event allows you to create an audible check of a switch position simply by touching the switch.

To create a Touch Switch Report:

1. From the Audio Events menu, touch Touch Switch Reports.
2. Touch the ( **+** ) to add a report.
3. Touch the ( **>** ) to edit the new report.
4. Touch **Inhibit** to access the list of available switches.
5. Scroll through the list to find the desired switch or simply touch the switch on the transmitter. The available switch positions are displayed on the screen along with a text field for each position.
6. Enter the desired text for each switch position by touching the ( **✎** ). Use the keyboard to enter the text or touch the microphone ( **🎤** ) on the keyboard to use the speech-to-text function.

7. Touch the (  ) to accept the changes and return to the report details menu.
8. Select **“On Release”** or **“On Touch”** to determine when the report will sound.  
On Touch is the default.
9. Touch the back arrow (  ) to return to the Touch Switch Report menu or touch and hold to return to the dashboard.

## ADJUSTING TOUCH SWITCH SENSITIVITY

The touch sensitivity of the various switches can be adjusted through the Calibration menu in System Settings.

1. From the dashboard, touch **System Settings**.
2. Touch the Calibration menu option.
3. Touch and hold **PROCEED** to continue to the Calibration screen.
4. Select **Touch Sensitivity** to access the Touch Switch Sensitivity menu.
5. Select on any of the values to adjust the sensitivity. The sensitivity of the switch increases as the numerical value increases.
6. Touch the back arrow (  ) to return to the Calibration menu or touch and hold to return to the dashboard.



# TRIM REPORTS

The Trim Reports menu allows for changing how the system signals trim inputs. Defaulted as tones, the trim reports can be set to tone, vibration, tone and vibration, or none.





To change the Trim Reports:

1. Select a channel from the Trim Reports menu.
2. Touch the drop down menu button to select the report type: Tone, Vibe, Tone/Vibe, or None.
3. If either of the Tone report types are chosen, the default tone will be used, or touch the pen icon (  ) to select a third party audio file.
4. Touch the back arrow (  ) to return to the Trim Reports menu.

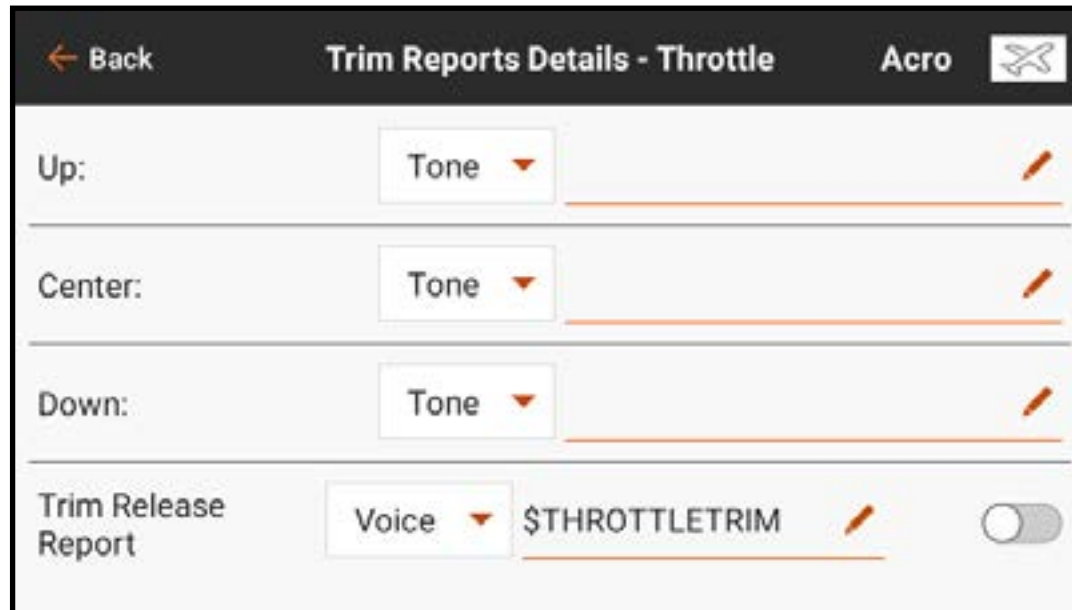

# TRIM RELEASE REPORT

Trim Release Reports inform the pilot the trim has been moved. Normal trim reports do not work with voice reports because they would sound a report with every trim switch movement. Trim release reports only announce when the trim switch movement stops. Only the primary flight control channels with trim adjustment available may be set up for Trim Release Reports. Trim Release Reports are disabled by default.

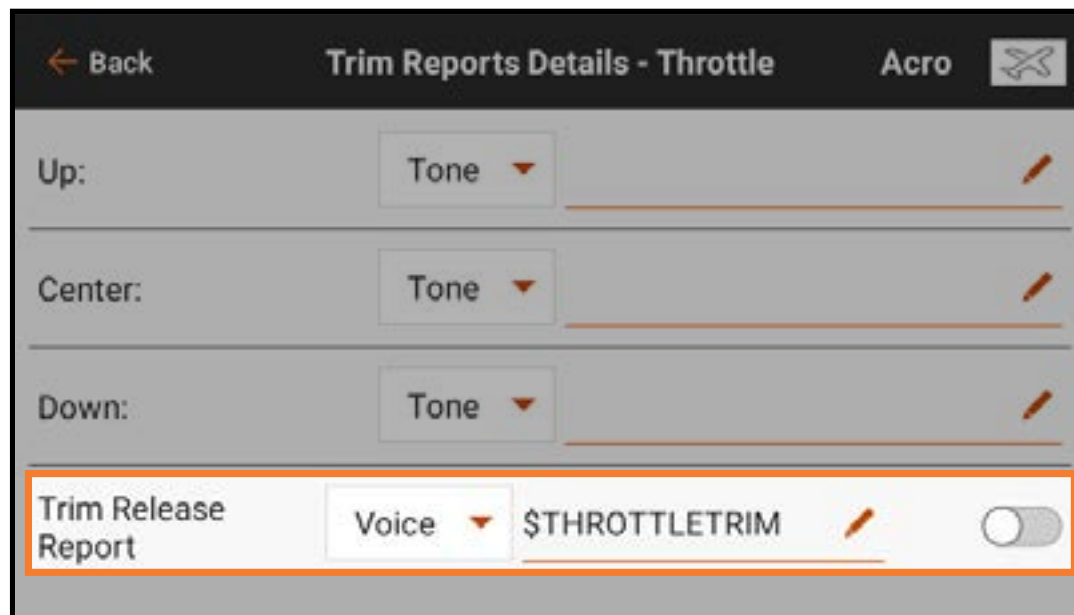

To enable a Trim Release Report:

1. From the Trim Reports menu, select the desired channel. Swipe to the bottom of the page to access **Trim Release Report**.
2. Select the type of report from the drop down menu. Only **Voice** and **Voice/Vibe** options are available.
3. The text-to-speech field is populated by default with a Macro which will report the trim position. This field may be left alone or changed to report as desired.
4. Touch the switch to enable the report.

# TELEMETRY WARNINGS

Telemetry features that have been activated in the Model Setup, Telemetry menu can be refined or left at the default settings.

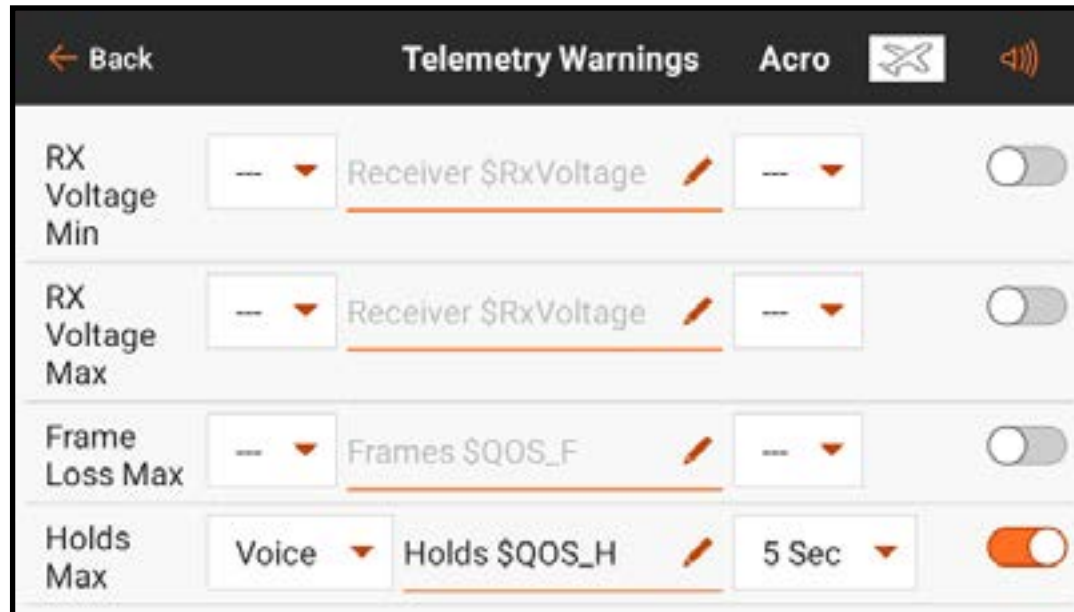

# STEPPING REPORTS

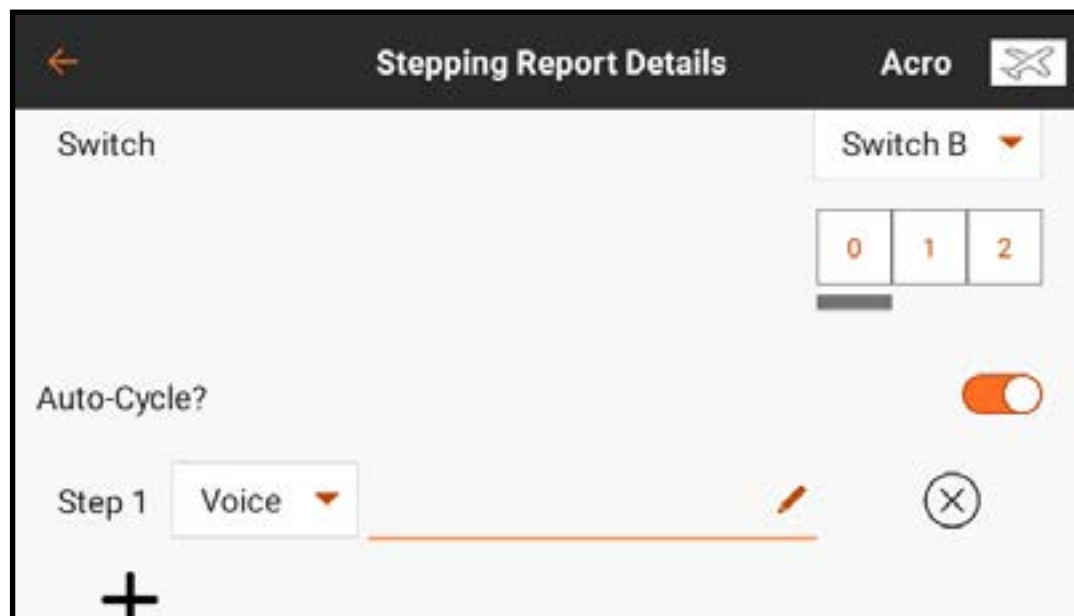

The Stepping Reports menu allows linking multiple alerts to a single switch. A report is spoken at the chosen switch positions. The reports can be tied to any switch regardless of any other assignments. Enable **Auto-Cycle?** to make the reports start again at the top of the list after it has completed the last step. When **Auto-Cycle?** is off, after the last step is completed the stepping report will not restart until the model is restarted.



## TRAINER STATE REPORTS

The Trainer State Reports menu allows for changing the audio reports that indicate current control and connection status of the trainer system. Select the reports to activate when the transmitter transfers command in trainer mode or if the instructor transmitter loses the signal from the student radio.



Category	Report Type	Report Name	Edit	Toggle
Instructor:	Voice	Instructor Control		<input checked="" type="checkbox"/>
Student:	Voice	Student Control		<input checked="" type="checkbox"/>
No Signal:	Voice	No Student Signal		<input checked="" type="checkbox"/>

## CENTER TONE

The Center Tone menu allows the addition of an audio alert to indicate a given analog control input is centered. Touch the drop-down menu button in each control for the available options.

If Voice is chosen, touch the text input line to add text-to-speech.

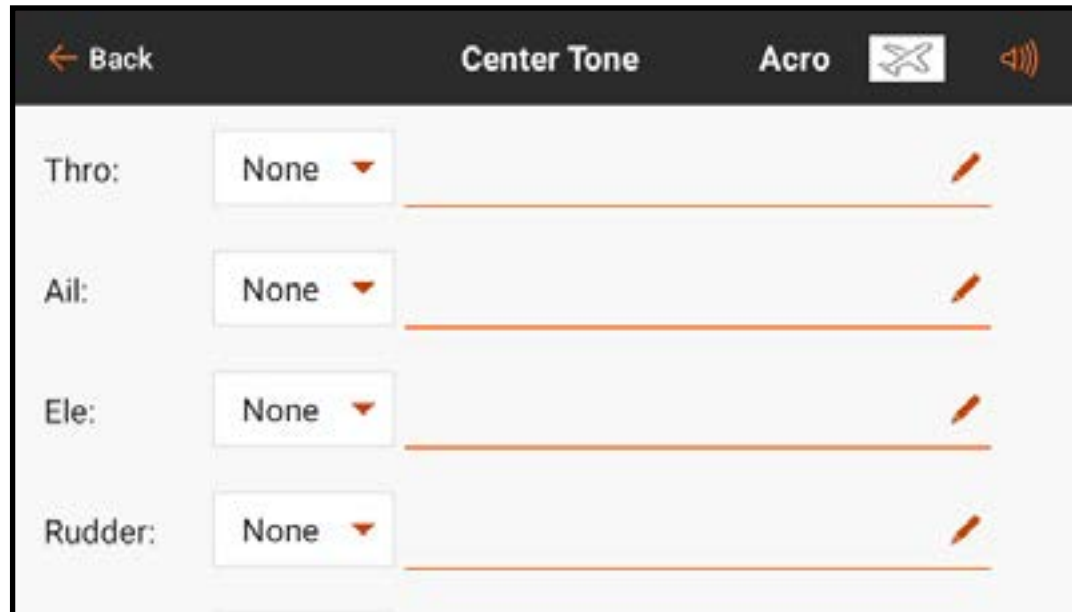

## MODEL START ALERTS

The Model Start Alerts menu includes three options: **STICK INPUT**, **SERVO OUTPUT** and **SWITCH**, which appear in the ribbon at the top of the screen. These options can be used to warn of the state of specific modes or features that are active when RF is powered on, such as high throttle or landing gear retracted. The configuration of these functions is defined in the Model Setup, Model Start Warnings menu. The Model Start Alerts menu only controls the audio alerts activated by those functions.

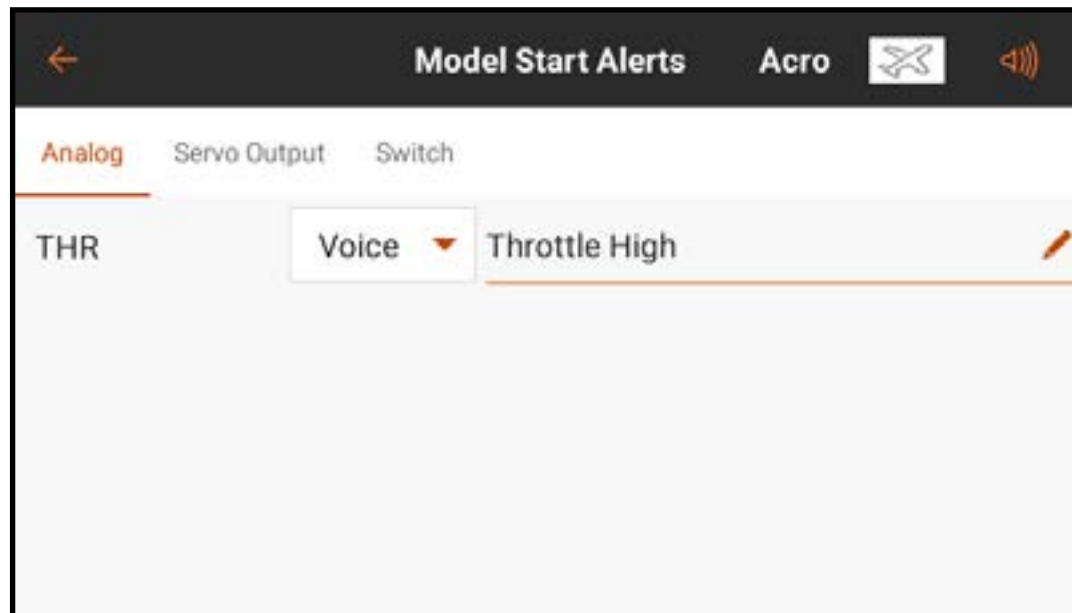



# PRE-FLIGHT CHECKLIST

Pilots can choose to configure a Pre-Flight Checklist to verify critical tasks are completed prior to flight. Under **Execute**, the pilot can choose whether to run the checklist **Every Flight** or **Per Session**. Set **Modulation** to On to transmit during the checklist or off to require completing the checklist prior to transmitting. Press the plus ( **+** ) to add a step. Edit each step individually by selecting the type of alert and adding text-to-speech. Select the ( **⊗** ) to delete an unwanted step.

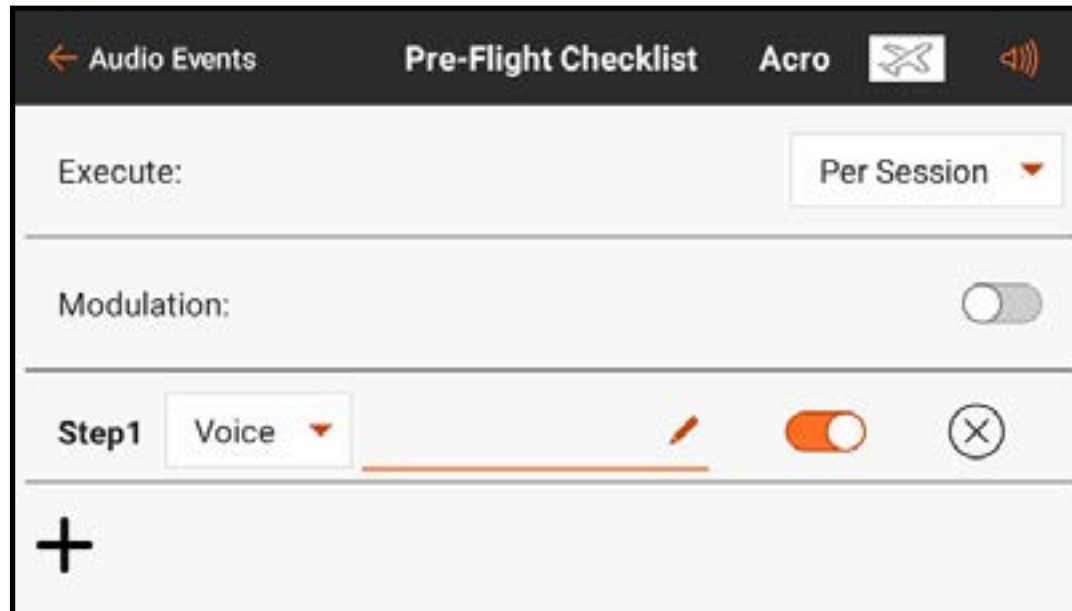

# SYSTEM SOUNDS

The System Sounds menu allows for changing what is spoken during the Transmitter Battery Warning and Transmitter Inactivity Warning alerts.

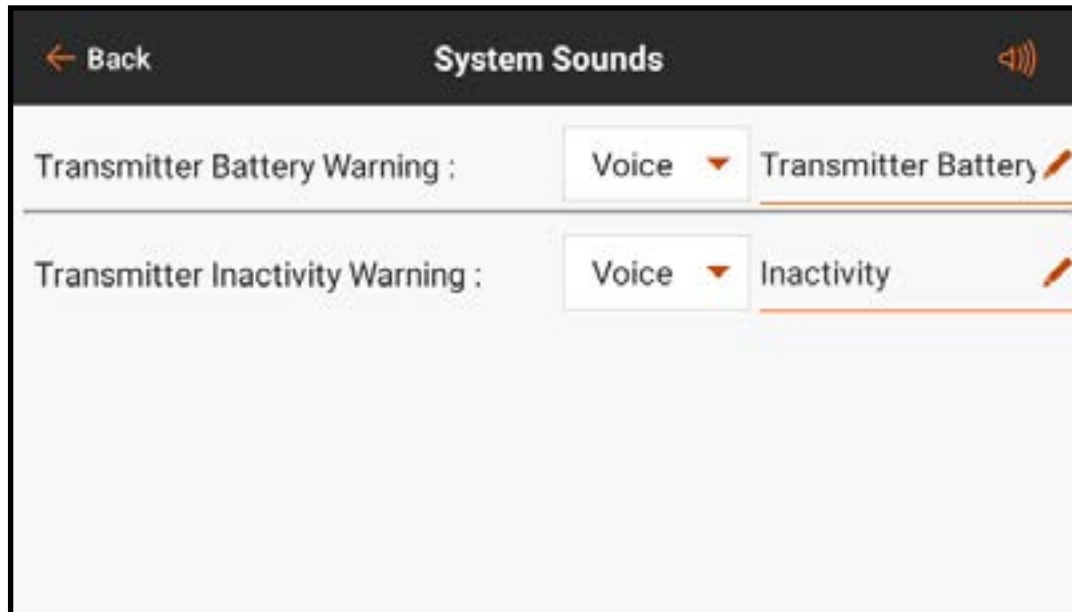

# SPOKEN FLIGHT MODE

All desired flight modes should be set up, using the Model Setup, Flight Mode Setup menu, prior to making changes in the Spoken Flight Menu. The number of available flight modes shown will match the modes created in the Flight Mode Setup menu. Defaults report the selected flight mode with a macro. The text is freely editable as well.

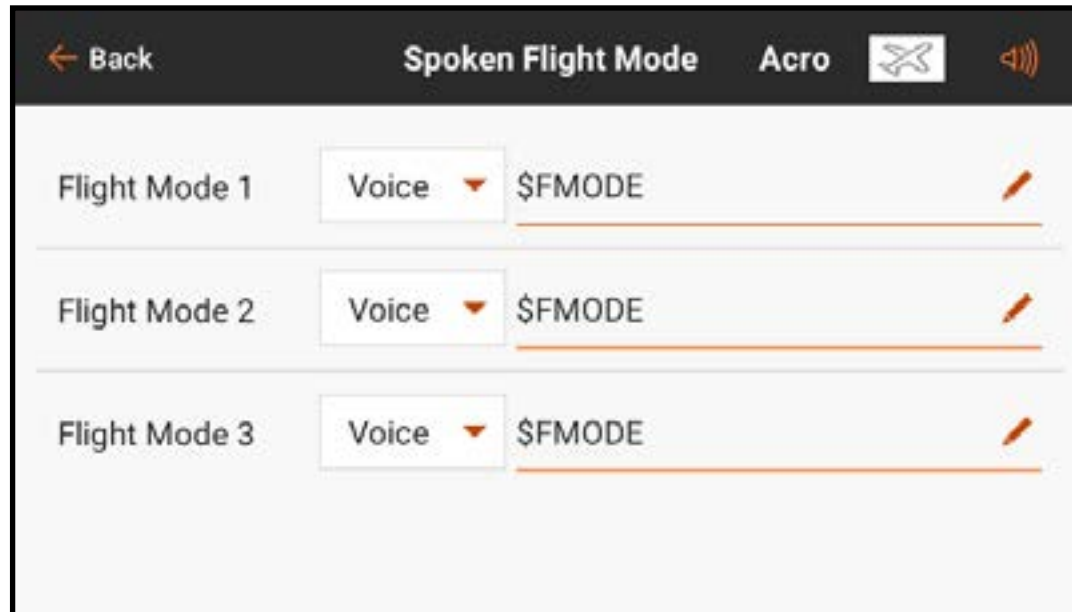

# BINDING ALERTS

The Binding Alerts menu allows changes to the alerts given during binding.

To change the Binding Alerts:

1. Select the binding alert to be edited.
2. Change the type of alert.
3. Change the spoken text.
4. Activate/deactivate each alert by touching on the on-screen switch.

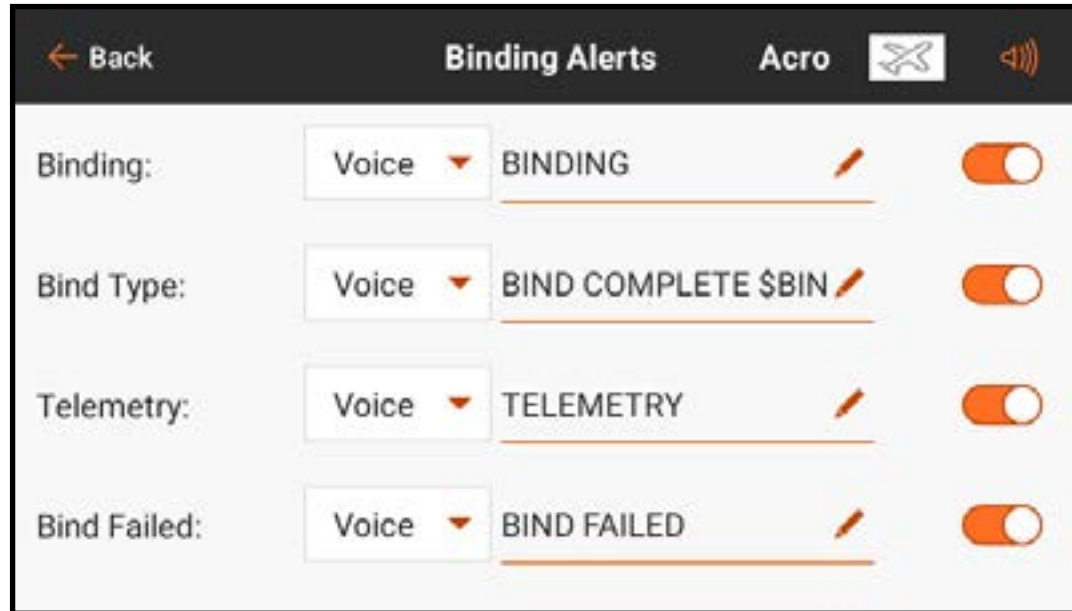

# TIMER REPORTS

The Timer Reports menu allows for editing the alerts given in either of the timers. Choose one of the timers listed to access the Timer Alerts menu for that timer.



From the Timer Alerts menu, select any of the **Timer Control Alerts** to change the alert type as well as the spoken text for the functions of the chosen timer. Select any of the **Alerts** to change the alert type as well as the spoken text for the time interval alerts of the chosen timer.

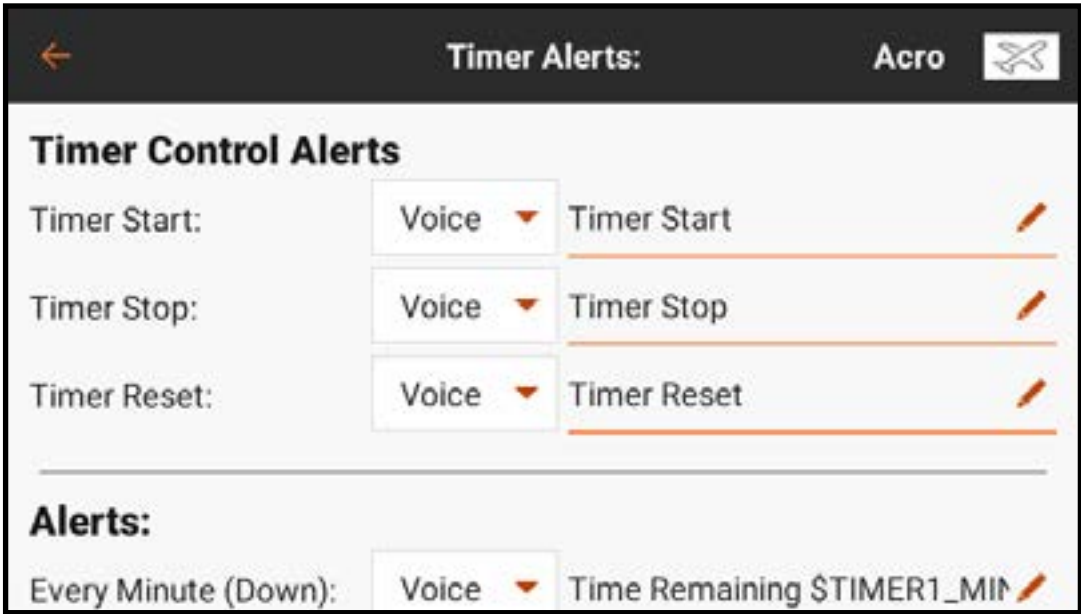

## CHANNEL ASSIGN

The Channel Assign menu defines what stick or switch controls each function. Channel inputs and receiver port assignments are both accessed from this menu.

- **Channel Input Configuration:** Allows each channel to be assigned to the desired stick, switch, button or slider. Channels are designated by their function. For example, throttle, rudder, elevator and aileron are channels.
- **Receiver Port Configuration:** Allows the numbered ports on the receiver to be assigned to any channel. Swipe to the bottom of the screen to access the receiver port assignment button.

# CHANNEL INPUT CONFIGURATION

In the Channel Input Configuration menu, all but the primary flight controls are available for assignment, indicated by a drop down menu button next to each channel.\*

1. Touch the drop down button next to the channel to open a switch selection menu.
2. Select the desired input device. A single input device can be assigned to multiple channels.

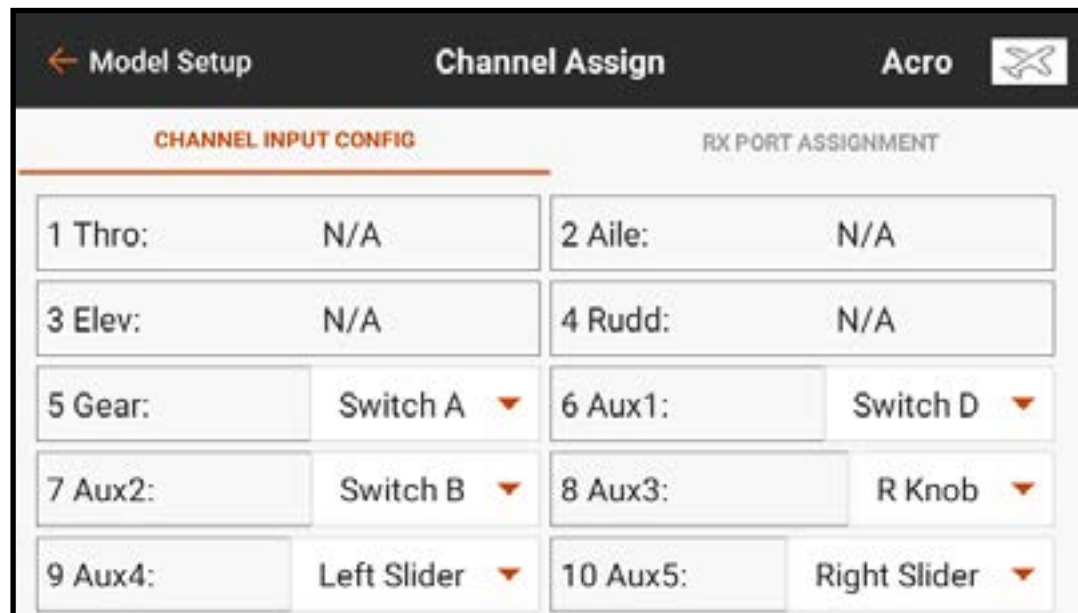

\* The primary flight controls are available for assignment when a multicopter model type, with the FPV Racer option off, is active. In this case, the channel input configuration is dependent upon the flight mode switch position, allowing one flight mode to have normal primary controls while another flight mode may, for example, release the throttle stick to be used as tilt control for a camera gimbal.



# RECEIVER PORT ASSIGNMENTS

Channels can be re-assigned to any receiver port. Receiver ports have default assignments in a familiar order; however, this can be re-configured so any of the channels can connect to any of the receiver ports.

Multiple receiver ports can be assigned to the same channel.

To change the receiver port assignments:

1. Touch and drag up to scroll to the bottom of the Channel Input Configuration menu.
2. Touch the **RX PORT ASSIGNMENT** button.
3. Touch the drop down menu button next to the receiver port.
4. Select the channel to be assigned to that receiver port.

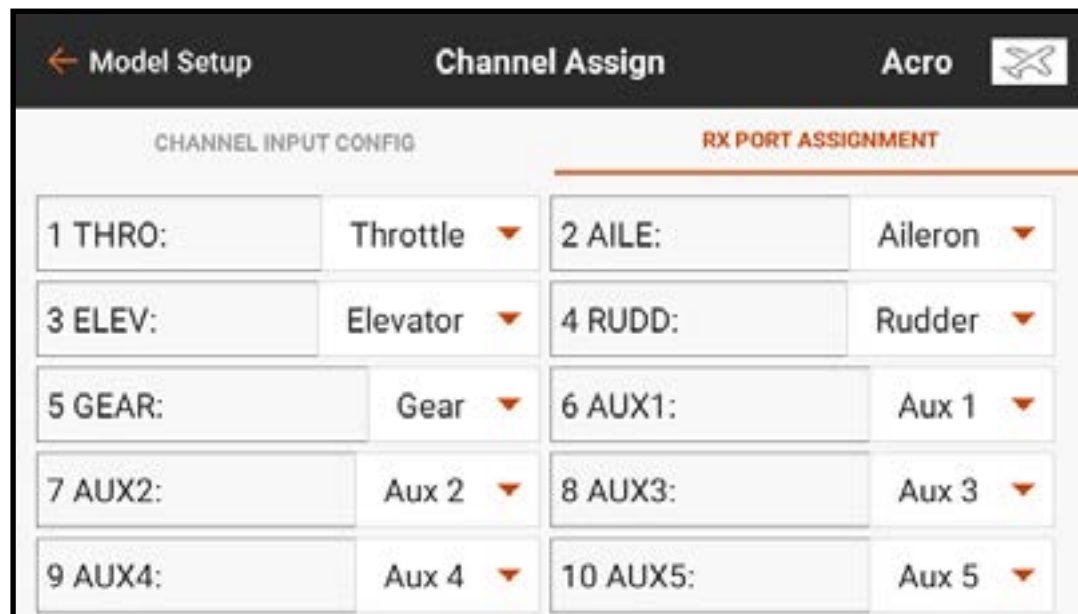

# TRAINER

All options related to programming and using the trainer functions are controlled with the Trainer menu.

Three options are available in the trainer menu:

- **Wired Trainer**
- **Wireless Trainer**
- **Trainer Alerts**

Wired Trainer and Wireless Trainer have similar options when connecting two transmitters for the purpose of training a student pilot. In addition, an advanced menu for FPV pilots in both the Wired and Wireless Trainer menus provides specialized functions needed specifically for FPV head tracking applications.



## WIRED TRAINER

Wired Trainer enables a student and instructor to work together by physically connecting two transmitters together with a cable.

The optional Spektrum wired trainer adaptor (SPMA3091, not included) and trainer cable (SPM6805, not included) are required for wired trainer operation. The wired trainer adaptor connects to the serial port on the back of the transmitter. The trainer cable plugs into the adaptor.

Wired trainer supports up to 8 input channels with PPM based trainer systems connected. If the iX14 is used with a wired connection, the correct wired trainer option must be selected in the trainer menu and the student mode started or the wired trainer connection will not work.

When Wired Trainer mode is selected, a drop down menu will appear. Select from the following trainer options:

- **Programmable Instructor:** This training mode designates the iX14 as the instructor, and requires the student transmitter to be fully configured, including reversing, travel, mixes, etc. This mode is helpful when the student has the full model configuration complete.

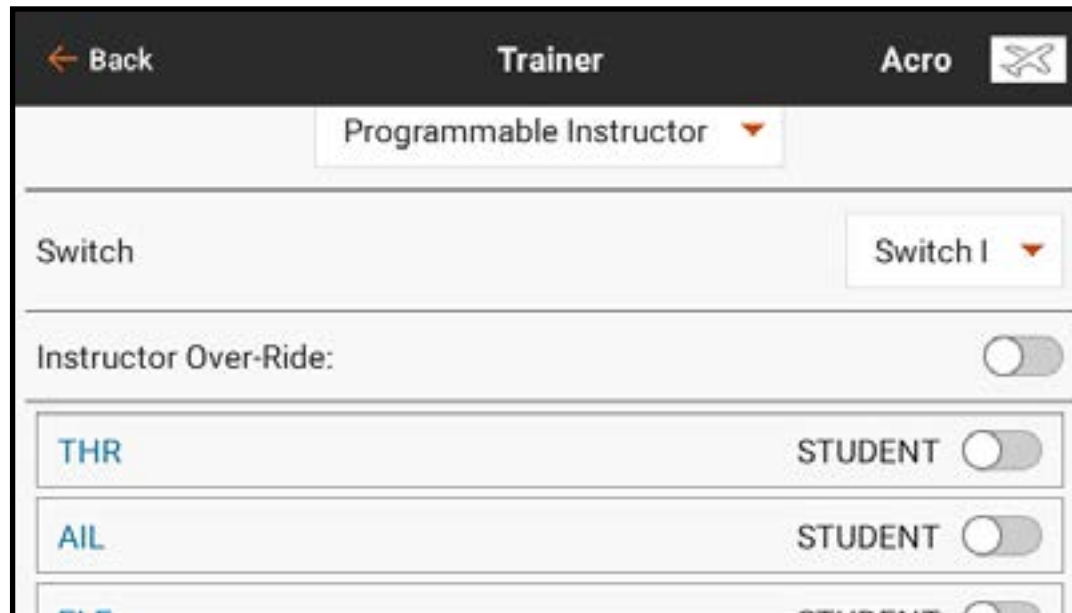

- **Pilot Link Instructor:** This training mode designates the iX14 as the instructor, and requires the student transmitter to have no settings applied, all of the reverse settings to normal and all travel settings at 100%. This option is intended to make it as simple as possible to connect any student transmitter to any airplane.

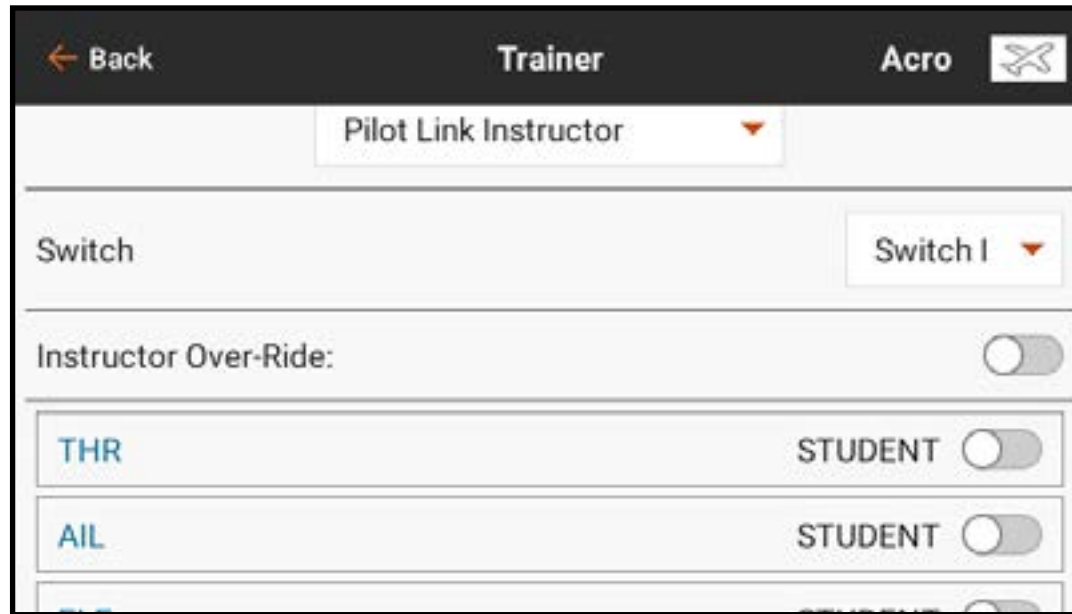

- **FPV:** This mode is available for connecting a head tracking system to the iX14 for FPV use. See the Headtracking FPV Setup section for more information.
- **P-Link Student:** This training mode designates the iX14 as the student transmitter. Use this option if the instructor transmitter is set up with Wired Pilot Link Instructor. A **Start Student Mode** button appears, which activates and deactivates wired trainer student capabilities. In this mode, the iX14 should be left on a default ACRO model with no changes.

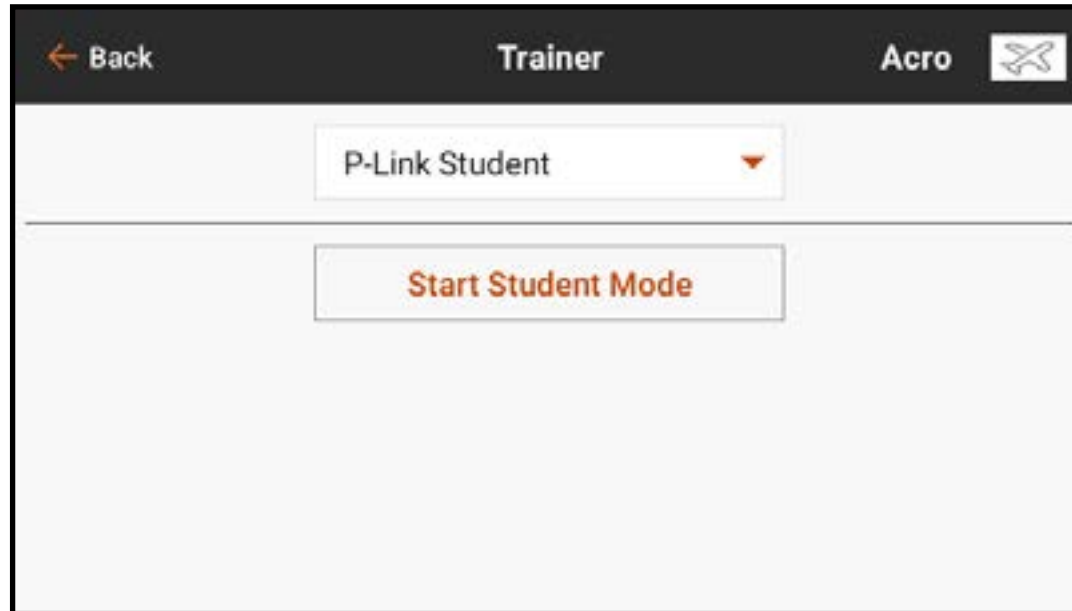

- **Normal Student:** This training mode designates the iX14 as the student transmitter. Use this option if the instructor transmitter is set up with Wired Programmable Instructor. A **Start Student Mode** button appears, which activates and deactivates wired trainer student capabilities. In this selection the iX14 must be fully configured to operate the aircraft.

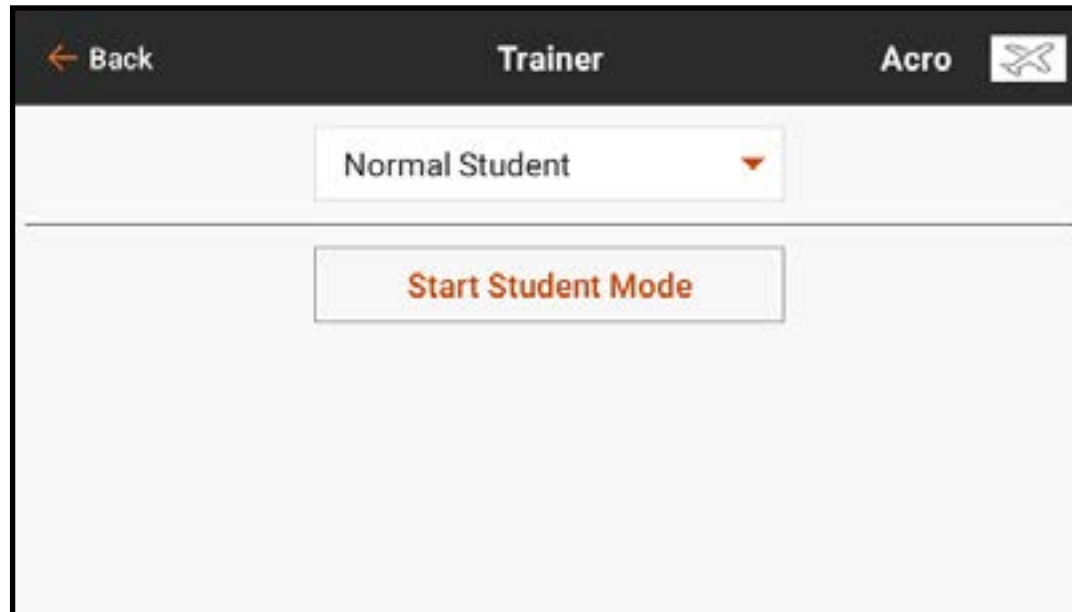

## WIRELESS TRAINER

Wireless Trainer enables instructors and students to work together without any cables connecting the transmitters. Wireless Trainer supports up to 20 channels of input depending on the number of channels available from the student transmitter or wireless headtracker. It is only necessary to put the instructor transmitter into the special wireless trainer bind mode. The student transmitter uses the normal binding process. Wireless Trainer modes are compatible with any Spektrum DSMX or DSM2 transmitter, Spektrum Focal<sup>®</sup> Headsets, and the small MLP4 and MLP6 transmitters from Horizon Hobby RTF models which include Spektrum technology.



When wireless trainer mode is selected, a drop down menu will appear with the following options:

- **Programmable Instructor:** This training mode designates the iX14 as the instructor and requires the student transmitter to be fully configured, including reversing, travel, mixes, etc. This mode is helpful when the student has the full model configuration complete.

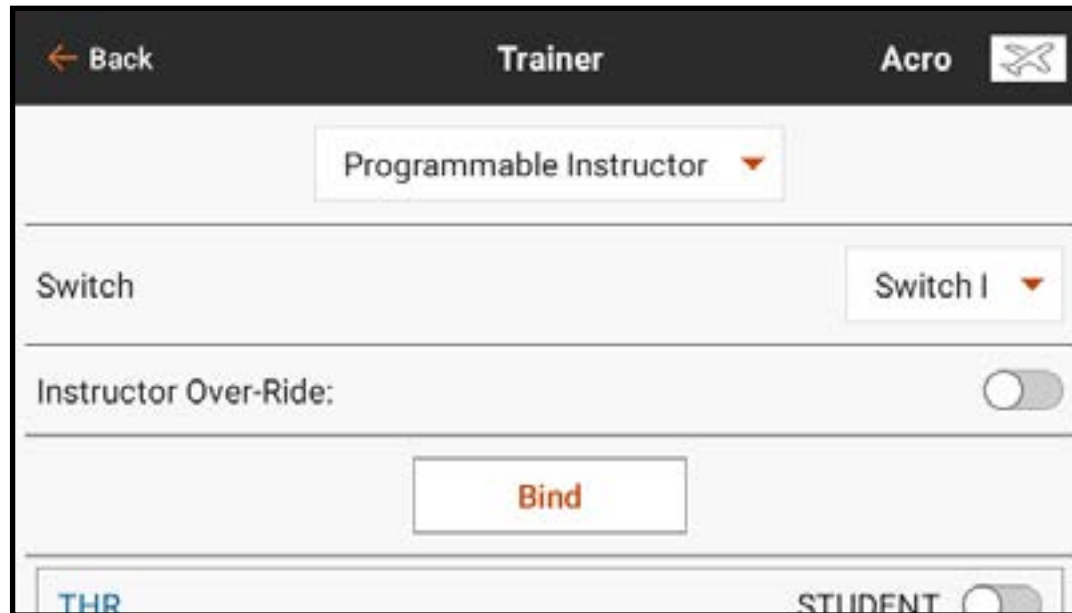

- **Pilot Link Instructor:** This training mode designates the iX14 as the instructor and requires the student transmitter to have no settings applied, all of the reverse settings to normal and all travel settings at 100%. This option is intended to make it as simple as possible to connect any student transmitter to any airplane.

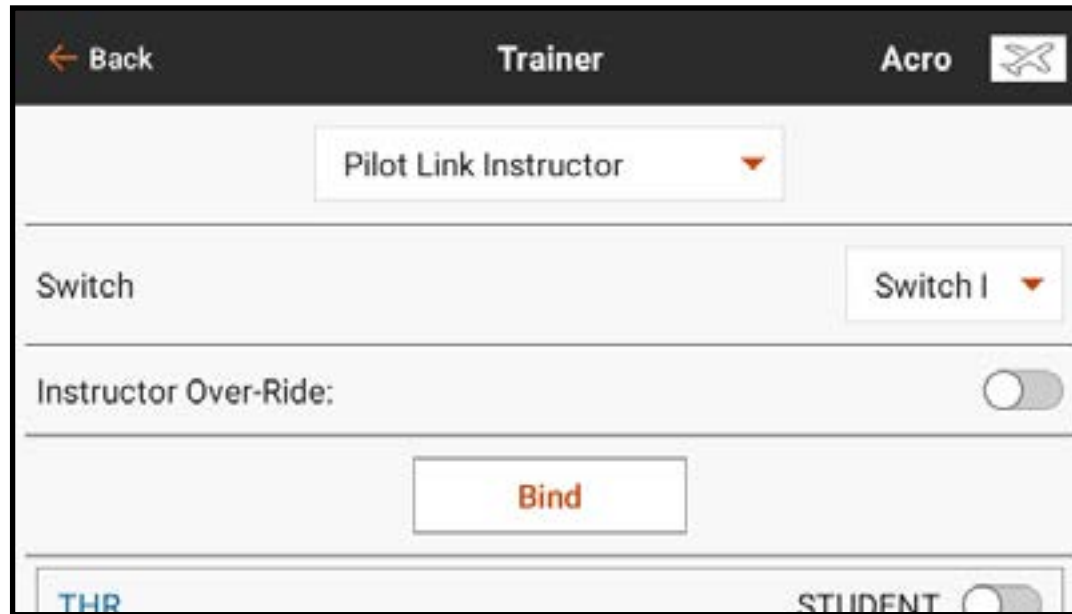

- **FPV:** This mode is available for connecting a head tracking system to the iX14 for FPV use. This option is covered further in the Headtracking FPV Setup section.

## TRAINER ALERTS

The Trainer State Reports menu allows the user to change the audio reports that indicate current control and connection status of the trainer system. Select the report activated when control is transferred between instructor and student or if the instructor transmitter loses the signal from the student radio.

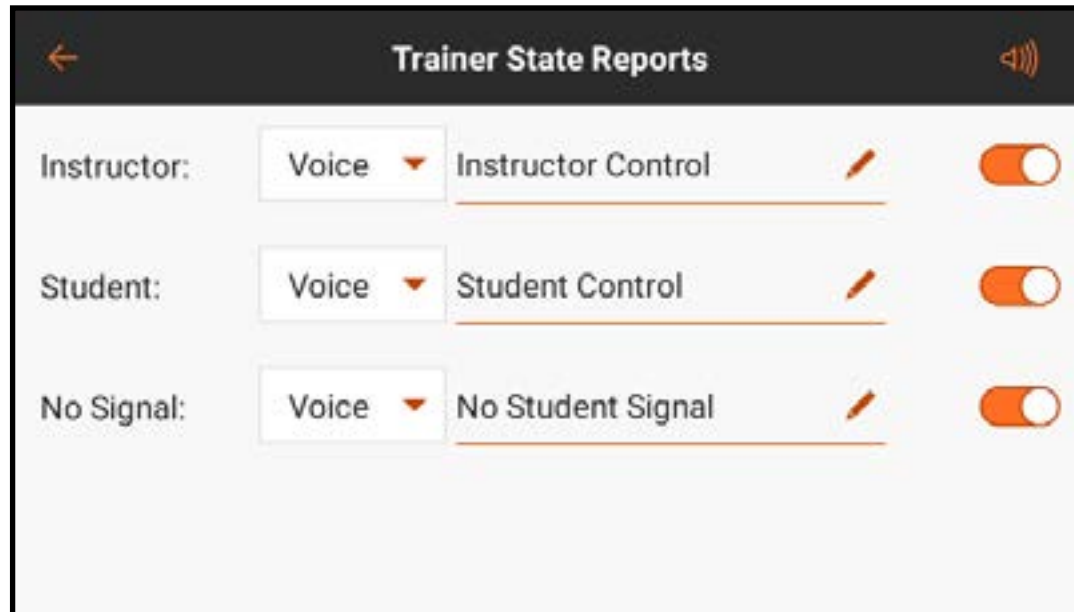

## INSTRUCTOR TRANSMITTER CONFIGURATION

1. Select the type of trainer mode for the application (Wired or Wireless, Programmable Instructor or Pilot Link Instructor).
2. Choose whether or not to enable **Instructor Over-Ride**. This setting defines how the instructor can resume control from the student. When enabled, the instructor must not move the sticks when the student is given control. Moving the sticks or moving the selected trainer switch will return control to the instructor.  
With Instructor Over-Ride disabled, the switch position determines who is in control. When Switch I or the right or left trim button is selected, Instructor Over-Ride is disabled by default. When any other switch is selected, Instructor Over-Ride is enabled.
3. If Wireless Trainer mode was selected in step 1, **Bind** the student transmitter to the instructor transmitter. See the Binding Wireless Trainer section.
4. Determine which channels to assign to the student when given control by moving the on-screen switch for each channel. Students can be given control of a single channel or all channels, as the instructor sees fit.

## BINDING WIRELESS TRAINER

Binding the iX14 wireless trainer feature as an instructor transmitter is not the same as binding the iX14 to an aircraft. The iX14 has a built-in receiver dedicated to the wireless trainer. The wireless trainer menu screens include a **Bind** button within the menu.

5. Touch the **Bind** button in the Wireless Trainer screen to enter trainer bind mode.
6. Long press on **BIND**.
7. Place the student transmitter in normal bind mode.
8. When the transmitters have completed the binding process, check the settings by opening the monitor screen on the instructor transmitter, giving control to the student transmitter and checking the monitor for correct control outputs.

# HEAD TRACKING FPV SETUP

**Wired FPV Mode:** Enables the use of a headset with head tracking or another transmitter to control an onboard camera gimbal by physically connecting to the iX14 with a cable. The optional Spektrum wired trainer adaptor (SPMA3091, not included) and a trainer cable (SPM6805, not included) are required for wired FPV operation. The wired trainer adaptor connects to the serial port on the back of the transmitter. The trainer cable plugs into the adaptor. The wired trainer is compatible with PPM based trainer links.

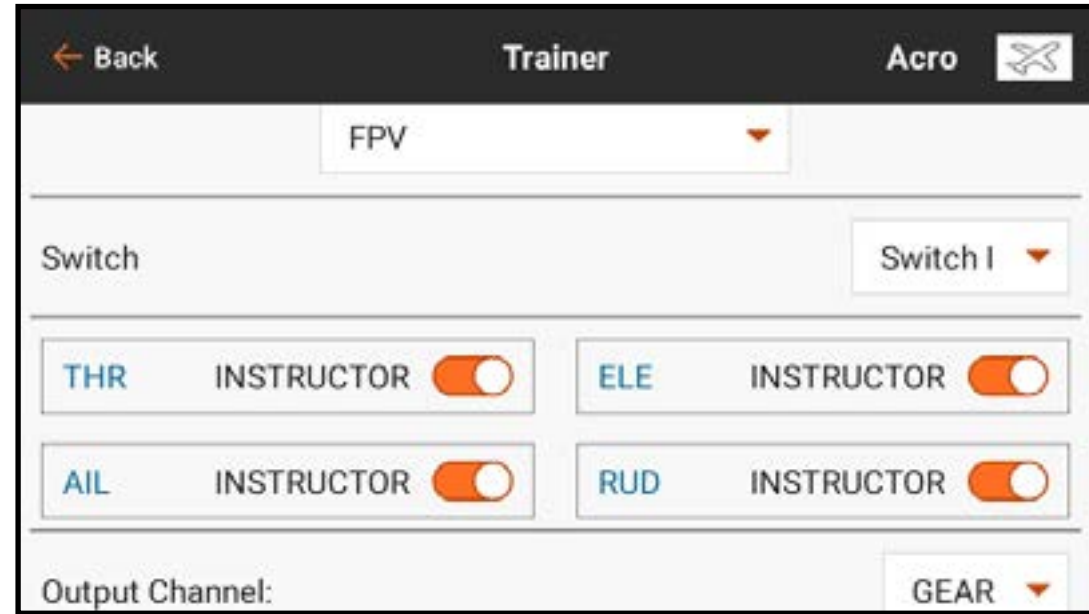

**Wireless FPV Mode:** Enables the use of a Spektrum Focal headset with head tracking or another DSMX or DSM2 transmitter to control an airborne camera gimbal without connecting the iX14 to a cable. Wireless FPV modes are compatible with any Spektrum DSMX or DSM2 transmitter and Spektrum Focal headsets.

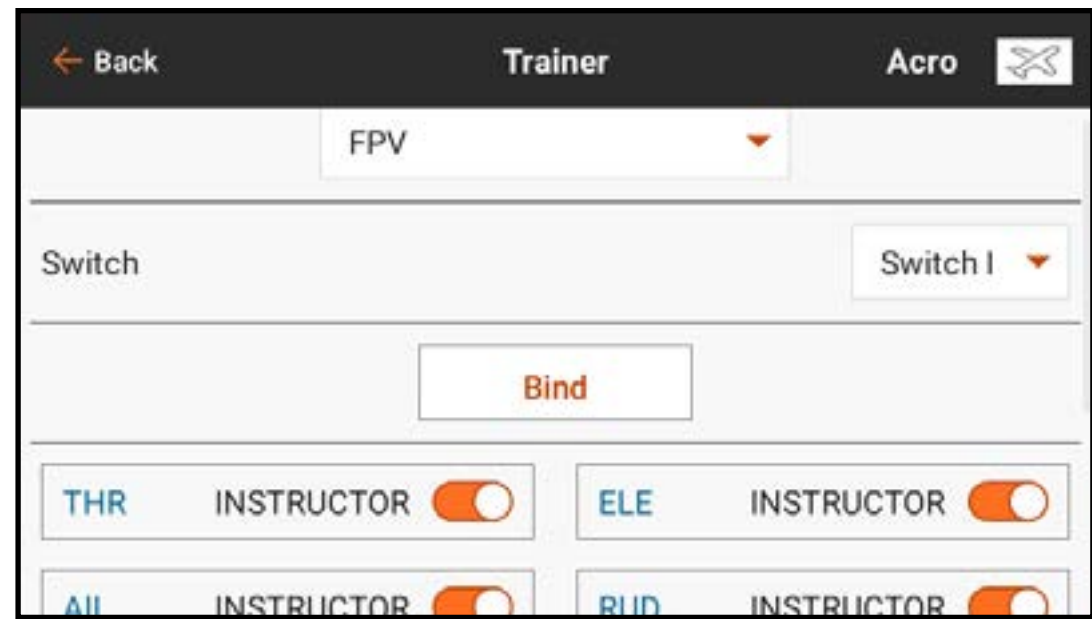

Each individual output channel can be mapped to any input channel from the trainer signal, leaving all other controls on the instructor transmitter. Primary flight control channels default to instructor control. Leave all channels connected to flight controls set up as instructor when using a headtracker.

To configure headtracking FPV:

1. Select either Wired or Wireless Trainer from the Trainer menu.
2. Select the FPV trainer mode.
3. Select the switch to enable/disable the head tracker.
4. Select the first **Output Channel** to be controlled. For example, if the pan servo is plugged into channel 5, select channel 5 as the output. Each axis of the gimbal will go to a separate output channel.
5. Change the mode to **STUDENT**. This selection only applies to the selected output channel.





6. Select the **Input Channel** from the trainer that controls the selected output channel when trainer is activated.
7. Input channels can be reversed or scaled in this menu to configure the student controls for correct response on the output channels. Normal servo setup menus for the output channel will be ignored when the trainer signal is commanding a given channel.
8. Repeat steps 4–7 to configure all the required output channels; select the **Output Channel** first, change the mode to **Student**, select the **Input Channel** and scale and reverse the travel as necessary.
9. For wireless connections, touch the **Bind** button to put the iX14 into trainer bind mode before powering on the wireless head tracker (student transmitter). See the Binding Wireless Trainer section for more information.

# RANGE TEST

The Range Test menu is used to confirm that receiver installation is working. From Model Setup, touch Range Test. Follow the on-screen instructions to perform a range test. This test should be performed multiple times from multiple model orientations to verify the radio component installation. Ensure the model does not experience any loss of control during the range test.

← Model Setup      Range Test      Acro 

1. Stand 30 paces away  30 paces
2. Press button I at the top of the transmitter to reduce power  Reduce Power:  
100% — ↓ 1%
3. Move sticks to see if model is still responsive 

**FULL POWER**

## FLIGHT LOG DATA

In addition to watching if the model loses control, more specific data is available from the receiver to learn how well the installation is working. Telemetry receivers report the receiver performance directly in this menu as well as on the Spektrum Airware dashboard telemetry screen.

Touch and swipe up to scroll to the bottom of the Range Test menu to see a display of the Flight Log Data telemetry information, if available.

The following information is displayed:

- **A:** Antenna fades on Receiver A
- **B:** Antenna fades on Receiver B
- **L:** Antenna fade on the left receiver
- **R:** Antenna fade on the right receiver
- **F:** Total number of frame losses
- **H:** Number of Holds

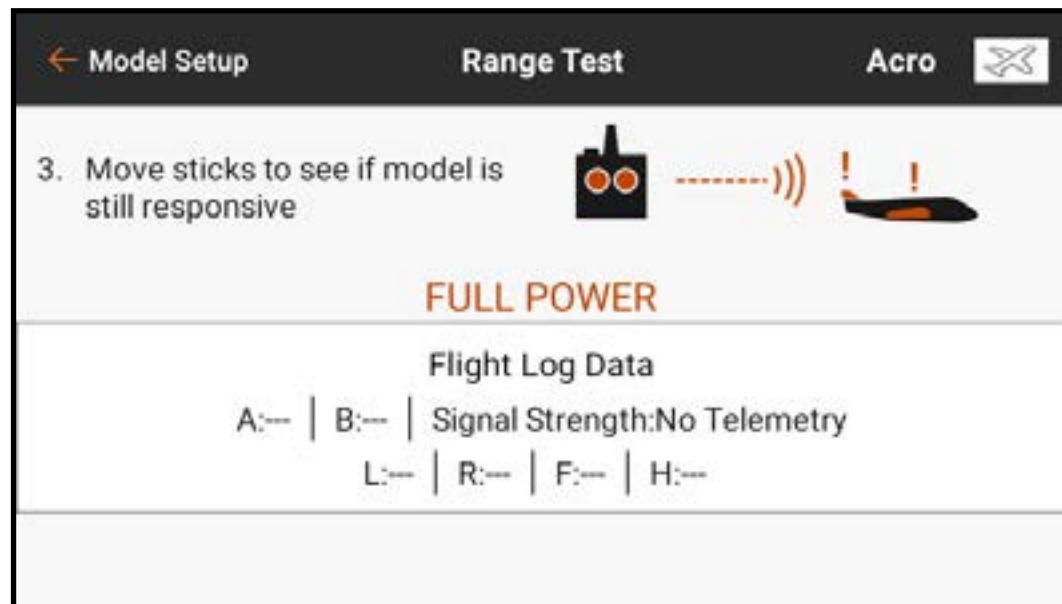

**Fade:** occurs when the receiver does not receive a complete data packet. A data packet is one sequence of numbers that represents all of the control signals for one instant in time.

**Frame Loss:** represents simultaneous antenna fades on all attached receivers. If one receiver experiences a fade, one of the other attached receivers can still pass a complete packet to the main processor, and the system proceeds without a recorded frame loss. Spektrum receivers without remote receivers will report the same data for frame losses and fades. The A, B, L and R antennas represent each remote receiver; they will not report data if a remote receiver is not connected.

**Hold:** occurs when 45 consecutive frame losses occur. If a hold occurs during flight or during a range test, re-evaluate the system. Relocate the receiver and/or check to make sure the transmitter and receiver are working correctly.

**TIP:** It is important to note the flight log data is reporting the reception quality of the Spektrum signal received at the model. It does not represent the telemetry link strength. The control link can take advantage of multi-link technology, while the telemetry signal cannot. It is normal for the telemetry reception to be less robust than the control link.

The operational differences between DSM2<sup>®</sup> and DSMX<sup>®</sup> receivers cause some expected differences in the telemetry data collected between the two systems. DSMX is frequency agile, while DSM2 finds two quiet channels and remains on those channels. Consequently, because DSMX operates on quiet and noisy channels, it's common to have more Antenna Fades and Frame Losses than when using DSM2 in busy 2.4GHz environments.

## GUIDELINES FOR DSM2 INSTALLATIONS

- It is normal to have as many as 50–100 antenna fades during a flight.
- If the RF link is performing optimally, frame losses per flight should be less than 20.
- Holds are unacceptable. If a hold occurs, investigate and correct the issue before next flight.

## GUIDELINES FOR DSMX INSTALLATIONS

- Use fades for comparison only. All attached receivers should have similar fades. If not, investigate poorly performing receivers (location, antenna orientation, etc) and correct.
- In conventional models during a normal flight, frame losses should be less than 100 on all receivers.
- Holds are unacceptable. If a hold occurs, investigate and correct the issue before next flight.

## RECEIVER INSTALLATION

Always install receivers where the antennas are placed as far possible from metal, batteries, wires, fuel tanks and other objects. Receivers with integrated telemetry should be installed with a focus on the antennas attached to the main part of the receiver in an optimal location, as this will be the only antenna transmitting telemetry information.

Remote receivers should be installed as far from the main receiver as is practical, with the antennas oriented  $90^\circ$  to the main receiver antenna.

Telemetry data can help diagnose receiver signal problems where the receiver is experiencing signal loss.



## MODEL START WARNINGS

Model Start Warnings are used to warn of the state of specific modes or features that are active when RF is powered on.

Three trigger options are available:

- **STICK INPUT:** Triggers the alert based on movement of one of the analog control inputs.
- **SERVO OUTPUT:** Triggers the alert based on the signal output command sent to the receiver.
- **SWITCH:** Triggers the alert based on a switch position.

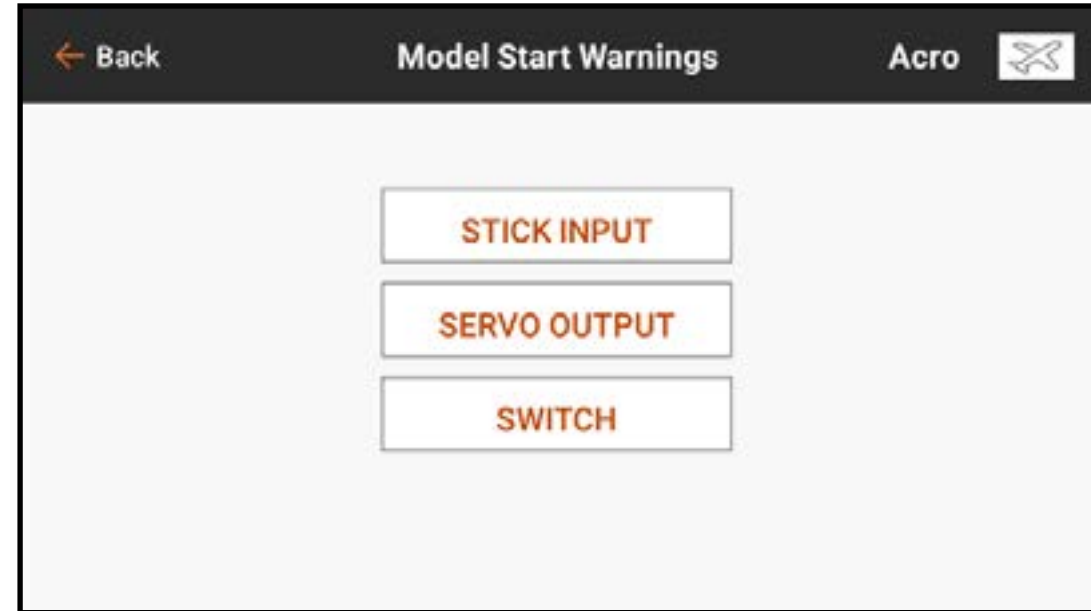

By default, the system warns when attempting to power on the RF signal with the throttle stick over 10% by speaking “Throttle High.” Multiple model start warnings can be configured. When attempting to power on the RF signal, the system lists every issue encountered. The system will not power on the RF signal until all warned issues are resolved. In the above case, the throttle must be lowered below 10% before the system will enable the RF signal. Similar warnings may be used for features such as retractable landing gear with a switch or channel output set up for the trigger.

To add a stick input model start warning:

1. From Model Setup, touch **Model Start Warnings**.
2. Select the **STICK INPUT** trigger type.
3. Touch the **+** icon to add a new warning. Touch the (**⊗**), if available, to remove a current warning.
4. Select the desired input from the popup menu.
5. Select **Over** or **Under** to define which side of the given input position the warning will trigger.
6. Define the trigger point value. Values from -100 to 100 can be entered.
7. Select the type of warning and enter text-to-speech if **Voice** is selected.

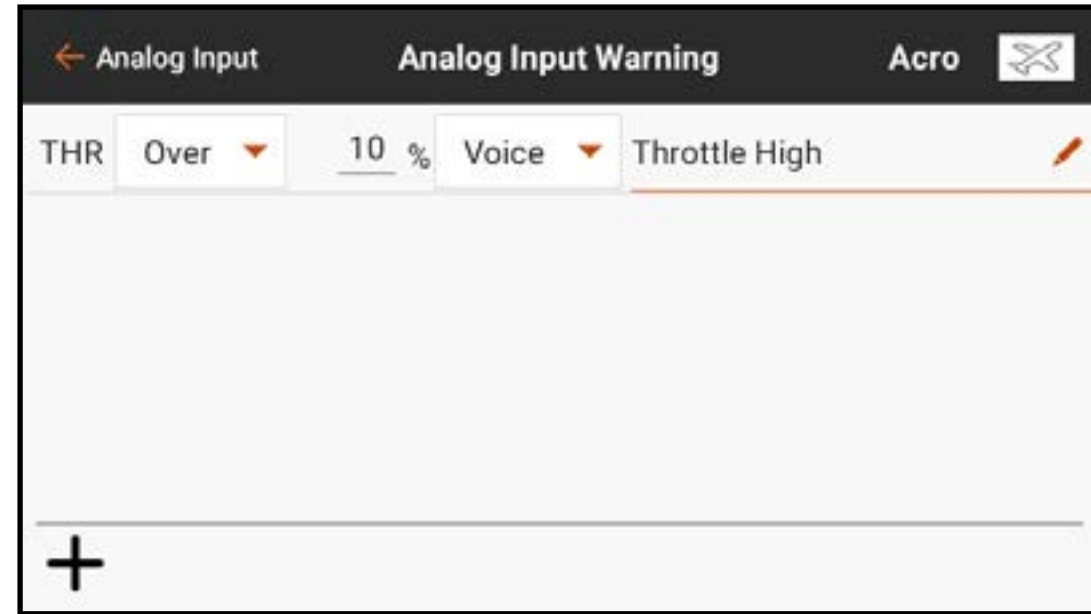

To add a servo output model start warning:

1. From Model Setup, touch **Model Start Warnings**.
2. Select the **SERVO OUTPUT** trigger type.
3. Touch the **+** icon to add a new warning. Touch the (**⊗**), if available, to remove a current warning.
4. Select the desired output channel from the first drop down button.
5. Select **Over** or **Under** from the next drop down button to define which side of the given output position the warning will trigger.
6. Define the trigger point value. Values from -100 to 100 may be entered.
7. Select the type of warning and enter text-to-speech if **Voice** is selected.

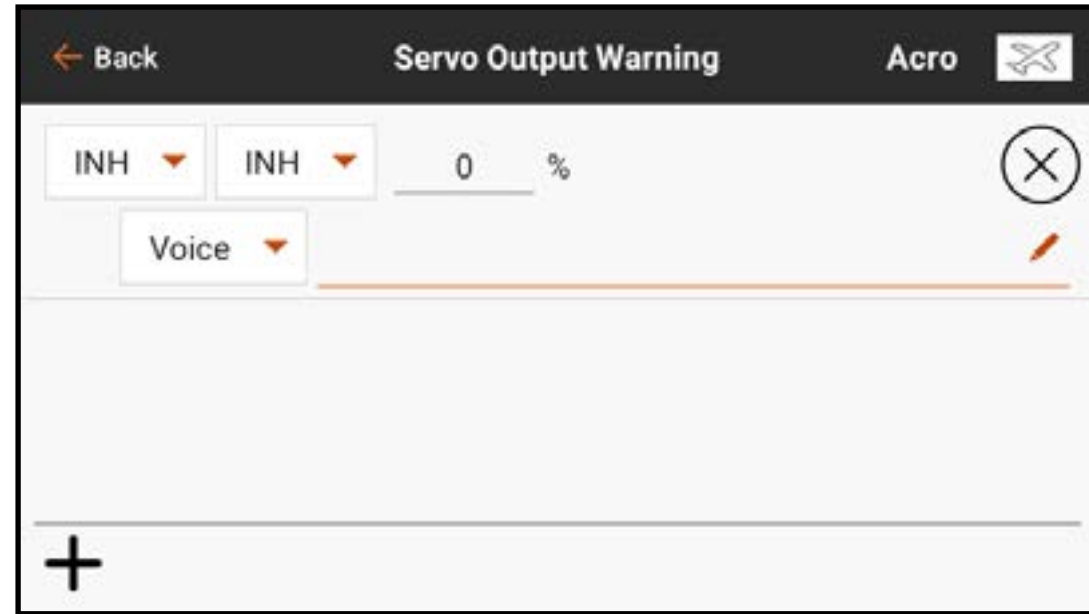

To add a switch model start warning:

1. From Model Setup, touch **Model Start Warnings**.
2. Select the **SWITCH** trigger type.
3. Touch the **+** icon to add a new warning. Touch the (⊗), if available, to remove a current warning.
4. Select the Switch dropdown button to select the desired switch.
5. Touch the switch position box to designate which position will trigger the warning.
6. Select the type of warning and enter text-to-speech if **Voice** is selected.

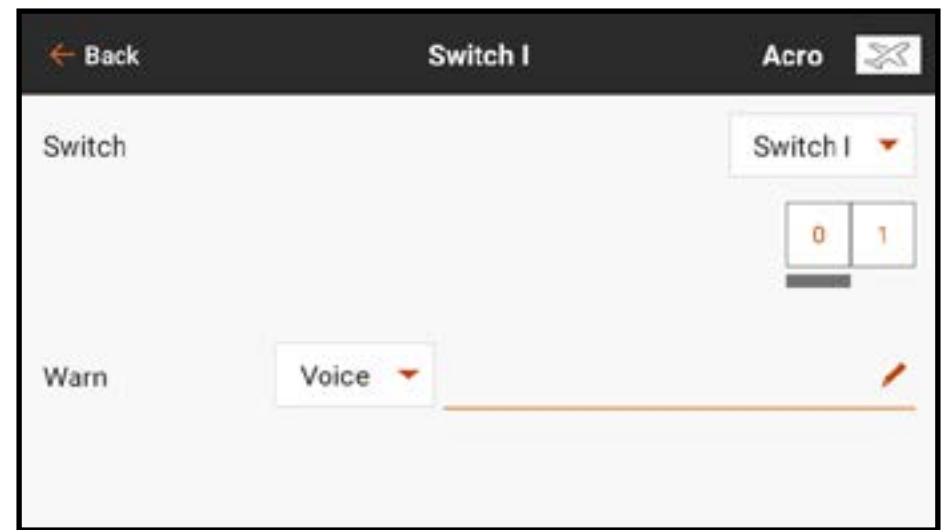
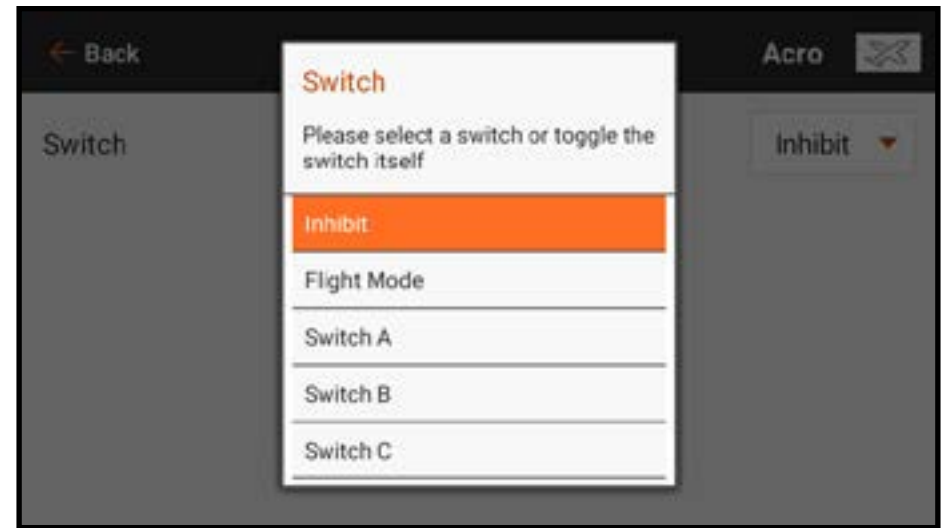

## SERIAL PORT SETUP

The Serial Port Setup menu manages serial port usage on the back of the transmitter. This port is designed to communicate with external RF devices using digital communication protocols. The iX14 includes the CRFS protocol for compatibility with the TBS Cross Fire and Cross Fire 2. In addition, the iX14 is engineered to deliver a 9.5V power supply for external devices. Any changes made in this menu will not be applied until the RF is re-enabled.

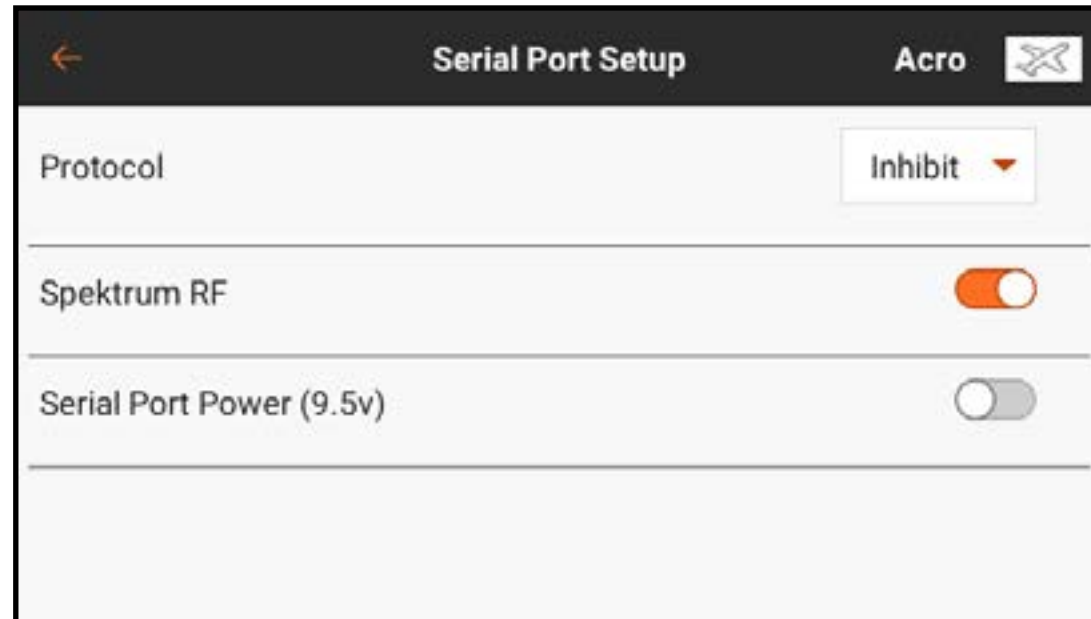

## SERIAL PORT PROTOCOL

Touch the **Protocol** drop down menu button. Select **Inhibit**, **Cross Fire** or **Cross Fire 2**. Selecting the Cross Fire or Cross Fire 2 options will enable the CRFS data stream. Connecting the Cross Fire system requires the Cross Fire serial port adaptor (SPMA3090, not included). Consult the manufacturer's manual for use of any external RF device. Horizon Hobby does not provide support for external RF devices connected to the iX14 transmitter.

## SPEKTRUM RF

The touch switch defines whether or not Spektrum RF is transmitted along with the data stream coming from the data port when other protocols are selected. The switch defaults to on when the **Protocol** is set to **Inhibit**.



## SERIAL PORT POWER (9.5V)

The Serial Port will provide 9.5V for external devices by selecting the touch switch. This power supply has been designed to support up to 1 amp of current. Battery use will be affected and the expected use time will decrease when using this option to power external devices. Set the Transmitter Battery Warning alarm in System Settings, System Configuration to 25% when powering external devices through the serial port to ensure there is ample reserve battery time to support current demands and ensure safe operation.

## AIRCRAFT TYPE

Aircraft Type defines what type of model configuration the iX14 is set up to control. Therefore, this menu should be the first step after creating a new model. The choices made in this menu define default channel assignments and enable pre-defined mixes with custom menus designed specifically for the selected application. This menu appears differently for each of the four model options chosen from during model creation in Model Utilities.

Choosing from the common configurations in this menu opens access to other menus not shown otherwise. Flaps, for example, can be assigned to a switch and made to function without using one of the pre-configured options. However, by assigning the correct wing type in the Aircraft Type menu, a Flap System menu is enabled in the Model Adjust list. The Flap System menu gives the pilot the choice of switches and a built-in elevator compensation mix, which makes fine-tuning an airplane for level flight throughout the flap range much easier. Options that enable mixes will label the default assigned channels in other menus, such as Servo Setup and Monitor.

In menu options, select an on-screen diagram that matches the control layout on the aircraft.

# AIRCRAFT TYPE (AIRPLANE)

## Wing

Choose from eleven common airplane wing control configurations. The default configuration is **Normal**, which is a single aileron servo configuration. For dual aileron wings, there are both **Dual Aileron** and **Flaperon** options. To utilize the built-in Flap System menu, select **Flaperon**. Selecting Dual Aileron will not enable the Flap System menu. There are two **Elevon** mixes. For airplanes that include elevons, try one option first. If reversing the aileron and elevator channels will not result in correct surface movement, try the other Elevon option.

## Tail

Choose from ten common configurations for rudder and elevator. Similar to the elevon options above, there are two V-tail mixes included. Try the first mix. If no combination of reversing will move the surfaces correctly, try the other V-Tail mix.

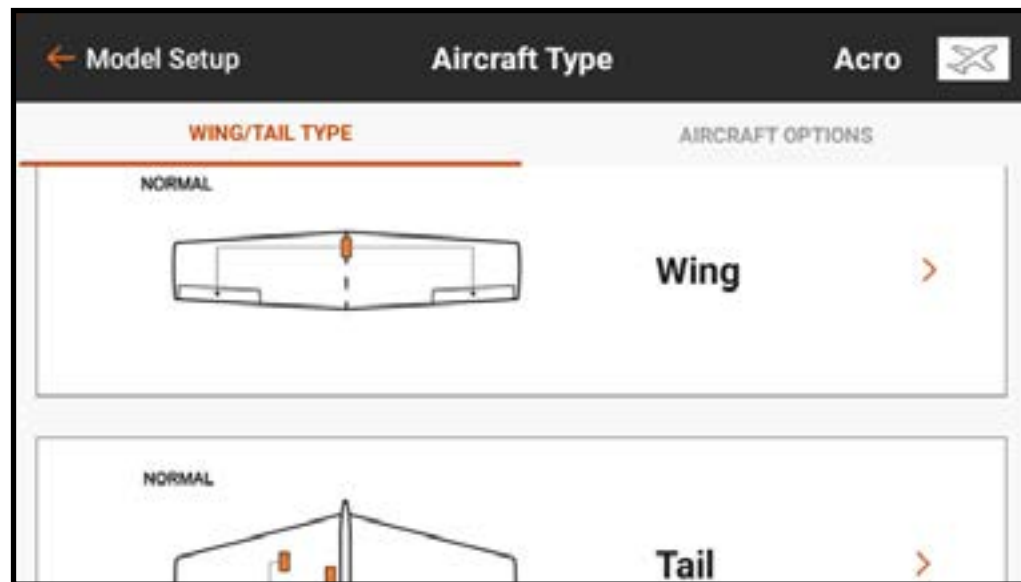

## Extra Options

Activating any of the Gyro or Pitch Curve options will enable a menu in the Model Adjust list to manage those functions.

**Throttle Mode:** **Normal** or **Reverse** defines how the pilot uses throttle. Most pilots use Normal (low throttle to the bottom of transmitter). For pilots who use reverse throttle (low throttle to the top of the transmitter, high throttle to the bottom), the iX14 can be configured as such for correct operation.

## SWASHPLATE TYPE (HELICOPTER)

When the model type is set to helicopter, this menu is called Swashplate Type. The diagram represents the top down view of the swashplate. Select the appropriate mix to match the helicopter swashplate.

Helicopters with flybarless control systems most often use the Normal configuration with no mixes applied. Consult the manual for the flybarless system for more information.

Choose from six common swashplate mixing options. Selecting a pre-configured mix (any option other than Normal) will enable the Swashplate menu in the Model Setup list to manage the various swashplate mixes.

# Collective Type

The Collective Type allows the throttle/pitch stick to operate in reverse and ensures trims, curves and all other functions that work in reverse function properly. Select reverse to fly with positive pitch at low stick and negative pitch at high stick.

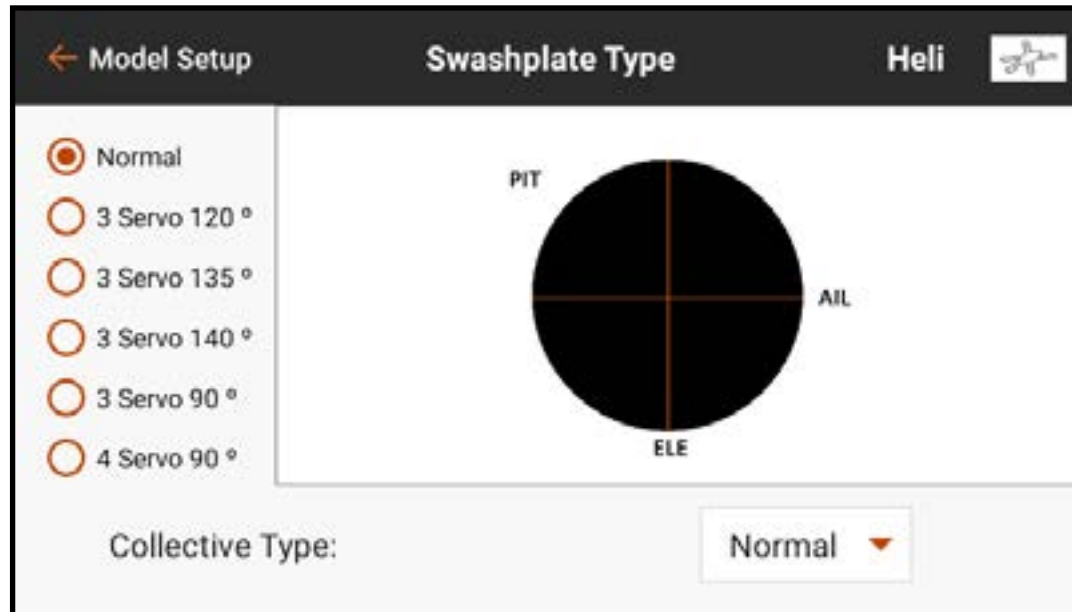

## SAILPLANE TYPE (SAILPLANE)

The Sailplane Type menu is similar to the Acro mode, but has more advanced features geared toward sailplane pilots. This menu is set up to support both powered and unpowered sailplanes. Unlike pilots flying conventional airplanes, it is common for sailplane pilots to use the throttle stick to manage speed on a sailplane with flaps, ailerons and spoilers; the throttle stick is called the Spoiler stick in the Sailplane-specific menus.

## Wing

Select from five common wing configurations to suit the aircraft. When a two servo or more wing configuration is selected, the Camber Preset and Camber System menus are included in the Model Adjust list.

## Tail

For V-Tail applications there are two options. Try one first and if no combination of reversing will make the control surfaces respond correctly, try the other. Selecting a V-Tail option will enable the V-Tail Differential menu in Model Adjust.

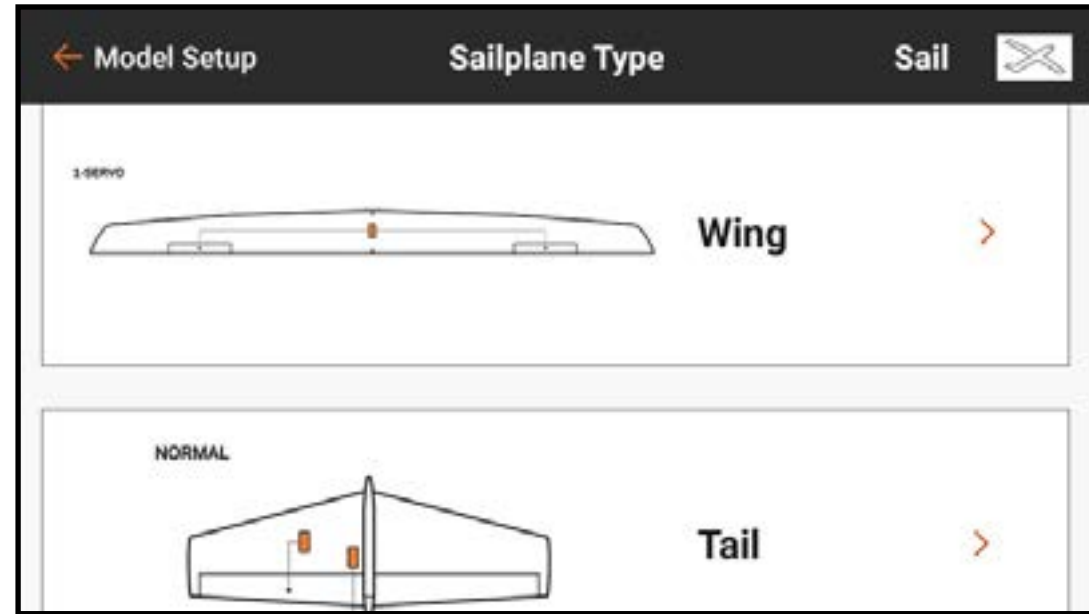



# Motor

Select the **Motor** drop down menu button to assign the motor function to any control stick or switch. The **Motor** option in the sailplane type defaults to **Inhibit**.

Four mixes are enabled in the Mixing menu in the Model Adjust list when the model type is set to Sailplane; Aileron > Rudder, Aileron > Flap, Elevator > Flap and Flap > Elevator.

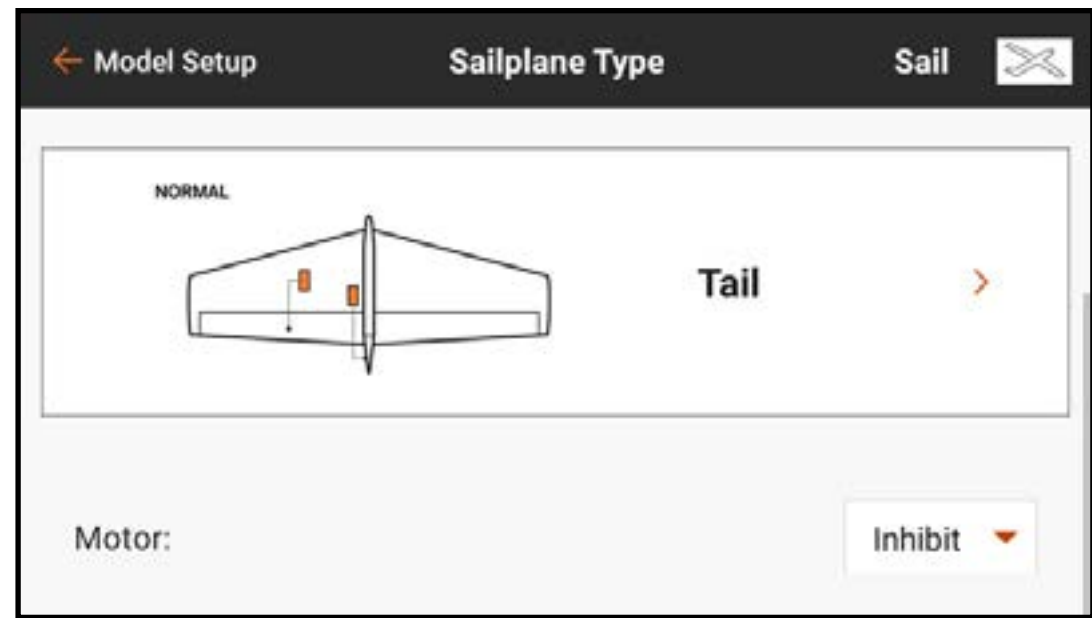

## AIRCRAFT TYPE (MULTIROTOR)

Selecting Multirotor for the model type during a new model setup will enable the multirotor Aircraft Type menu. This menu defines the number of rotors and camera mount axes and can be optimized for racing drones or aerial photography. The AP mode has advanced functions for aerial photography multirotors to enable pilots to use a control stick on the iX14 to fly the multirotor in one flight mode and control the camera from another.

**Rotor type:** Select the number of rotors on the multirotor.

**Camera:** Select the number of movement axes on the camera gimbal.

**FPV Racer:** This selection selects FPV Racer mode or AP mode. When FPV Racer mode is not enabled, multirotor models are in AP mode.

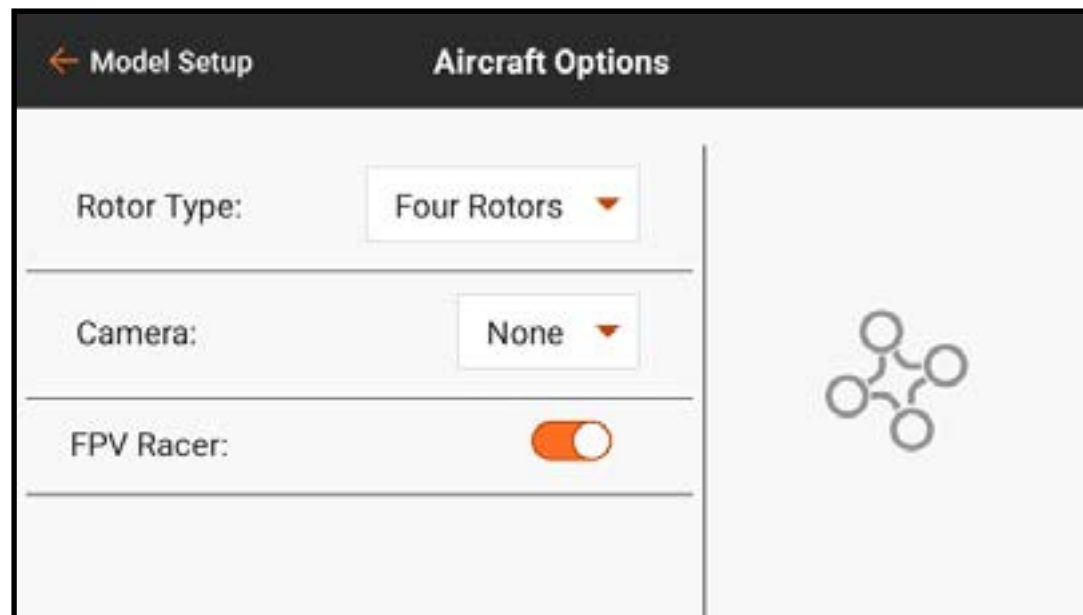

- FPV Racer mode optimizes the throttle channel by changing it to 11ms operation and keeps flight mode functions simple.
- AP mode includes a separate Channel Input Assignment menu tied to each flight mode. With this capability a pilot can configure the iX14 in AP mode so changing the flight mode can change the input source for the camera gimbal. For example, a pilot can configure flight mode 1 for slow speed flight, flight mode 2 for faster flying and flight mode 3 to put the multirotor into a position hold mode. The pitch/roll control stick can then be re-assigned to the camera pan and tilt commands. In this example, the pilot uses the first two flight modes to fly the aircraft. In those modes, the camera pan and tilt can be assigned to the sliders. In the third flight mode, the aircraft can take advantage of GPS technology\* to hold a position and the pilot can move the pitch/roll control stick to guide the camera gimbal without affecting the multirotor.

\*GPS technology for position hold are not part of the features of the iX14. This function must be installed on the flight controller onboard the aircraft.



**WARNING:** AP mode includes complicated channel assignment capabilities. Confirm operation works as expected with the motors disengaged before experimenting in flight.

## FLIGHT MODE SETUP

Flight Modes can help a pilot manage a wide variety of switches and functions. Pilots can use flight modes to manage rates, expo, mixes, audio alerts, and other functions. By defining several flight modes, pilots can maximize the aircraft's performance using different configurations without having to use multiple switches. Flight modes can include multiple flight modes on one switch or be linked together with other switches to define more than the three flight modes that one switch can manage. Flight mode setup allows the pilot to configure what flight mode is assigned to every combination of the assigned switches. Each model type setting includes a different set of default flight mode names to define which mode is being used. The spoken name for each flight mode can be edited with the text-to-speech function.

## EXAMPLES OF FLIGHT MODE APPLICATIONS

**Acro:** Airplane pilots can take advantage of flight modes to manage different phases of the flight, instead of having to operate different switches. For example, a scale airplane might have a flight mode for take-off with a few degrees of flaps, no elevator compensation, landing gear down, and low rates. Another flight mode can be used for a cruise mode that includes landing gear and flaps up, high rates, and the nose wheel steering servo disabled so it does not move with rudder input. A third flight mode for landing might include flaps fully deployed, landing gear down, elevator compensation, and low rates.

**Helicopter:** Helicopter pilots commonly use flight modes to manage the advanced curves common for helis. Flight modes might include a head speed setting for the governor, a gain setting for the tail gyro, a throttle and pitch curve, rates and expo. Using all of these features on one switch, a helicopter pilot can have flight mode 1 set up for low head speed and low rates, flight mode 2 set up for medium head speed and medium rates, and flight mode 3 set up for high rates. Instead of requiring a different switch to define each function, the flight modes link the multiple functions to a single switch. In the heli scenario, the throttle

curves and governor are used to perform aerobatics, but different head speeds change requirements on the tail gain, and the speed the helicopter responds also changes with head speed. By putting all of the related functions in flight modes, every function can be tailored to work correctly with the other settings in that mode.

**Sailplane:** Sailplane pilots commonly use flight modes to define a wide array of configurations, which can have a drastic impact on how a high performance sailplane flies. Advanced sailplanes often utilize complicated mixes to control wings with multiple servos. These mixes give the pilot the flexibility to select a flight mode that is tied to numerous functions. Pilots can have the throttle (spoiler) stick control nothing in Launch mode. In Cruise mode, it can control a limited amount of reflex travel. In Thermal mode, it can have full span flaps with limited camber travel. In Landing mode, moving the throttle stick can deploy a crow mix (ailerons up, flaps down). A full array of other options, such as appropriate rates and elevator compensation mixes and other features, can be individually tailored so the sailplane is optimized for each type of flying with just the simple selection of the Flight Mode.

# USING FLIGHT MODE SETUP

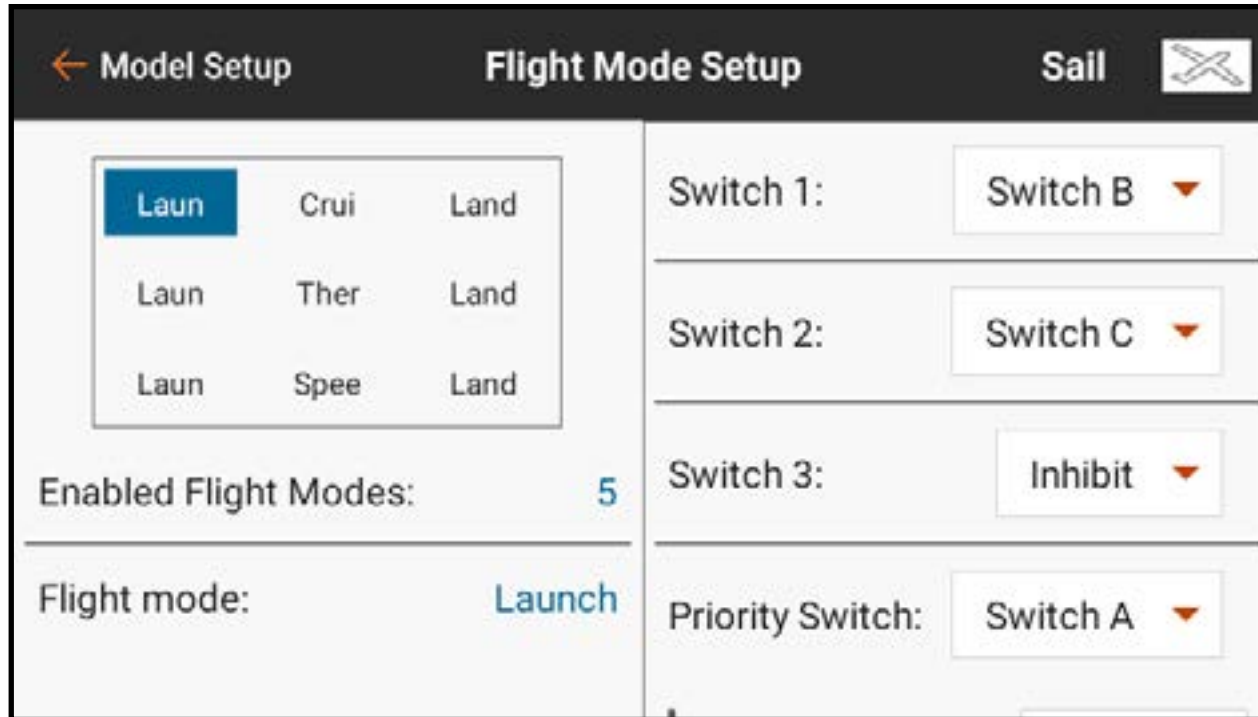

Assign a single switch for up to three modes. Swipe up the right side of the screen to scroll to the bottom of the menu and change the text-to-speech flight mode name or re-assign the currently selected switch position to a different flight mode.



Adding another switch will add more flight modes to the flight mode assignment table:

- Switch 1 will move the flight mode selection left or right in the table.
- Switch 2 will move the flight mode selection up or down in the table.
- Switch 3, if available, will add another group of flight modes. Changing this switch will move the flight mode selection up or down to the next group of options.

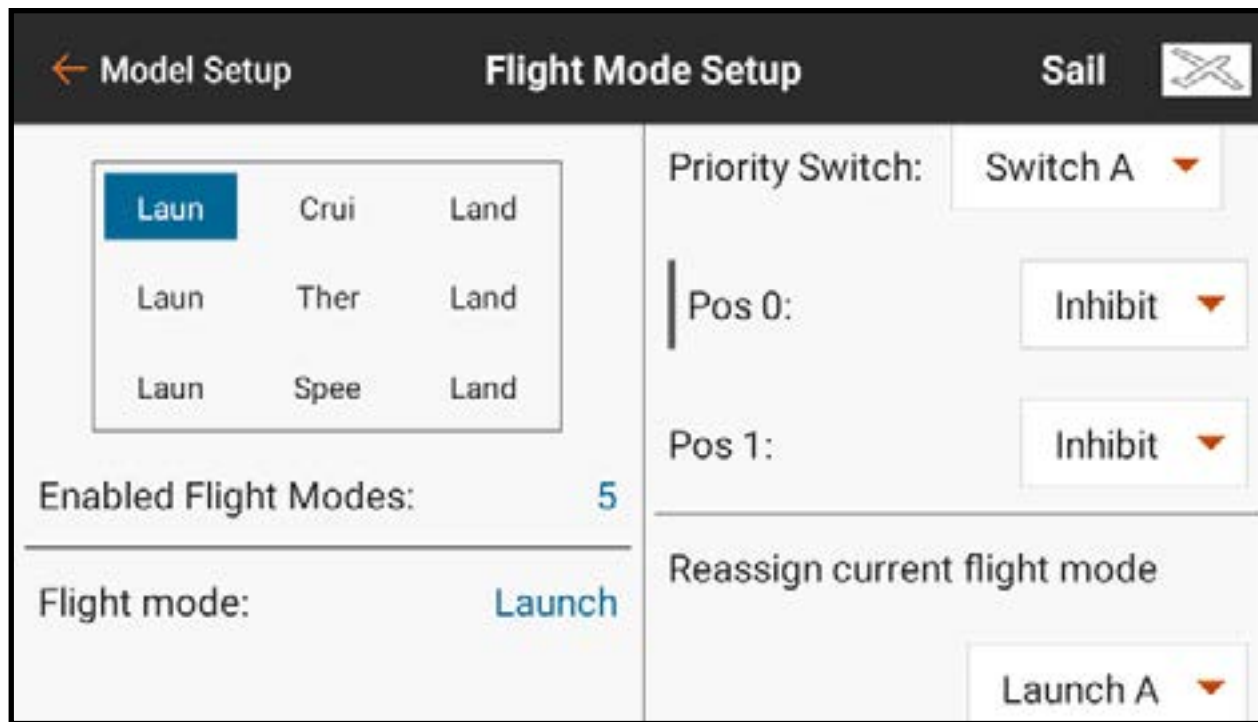

- The Priority Switch can override the table. One switch position will always be **Switches**. This position uses switches 1–3 to choose between the flight modes in the assignment table. The other switch positions can be assigned to specific flight modes.

# HOLD (HELICOPTER)

Hold, commonly referred to as throttle hold, is a flight mode that allows the pilot to eliminate power to the rotor blades while maintaining cyclic and blade pitch control. Hold is enabled in the Flight Mode Setup menu and is configured in the Model Adjust, Throttle Curve and Pitch Curve menus.

The screenshot shows the 'Flight Mode Setup' menu for a 'Heli' model. The menu is divided into two main sections. The left section contains a grid of flight modes, with 'N' (Normal) selected. Below the grid, it shows 'Enabled Flight Modes: 4' and 'Flight mode: Normal'. The right section contains three switch assignments: 'Switch 1: Switch B', 'Switch 2: Inhibit', and 'Hold Switch: Switch H'. At the bottom right, there is a toggle switch for the 'Hold Switch' set to position '1'.

← Model Setup	Flight Mode Setup	Heli									
<table border="1"><tr><td>N</td><td>1</td><td>2</td></tr><tr><td>-</td><td>-</td><td>-</td></tr><tr><td>-</td><td>-</td><td>-</td></tr></table>			N	1	2	-	-	-	-	-	-
N	1	2									
-	-	-									
-	-	-									
Enabled Flight Modes: 4		Switch 1: Switch B									
Flight mode: Normal		Switch 2: Inhibit									
		Hold Switch: Switch H									
		0 1									

To enable the throttle hold function, touch the **Hold Switch** drop down menu button to select the desired switch. Select the switch position(s) to activate Hold. After the Hold mode is enabled in the Flight Mode Setup, the curves can be adjusted in the Throttle Curve and Pitch Curve menus.

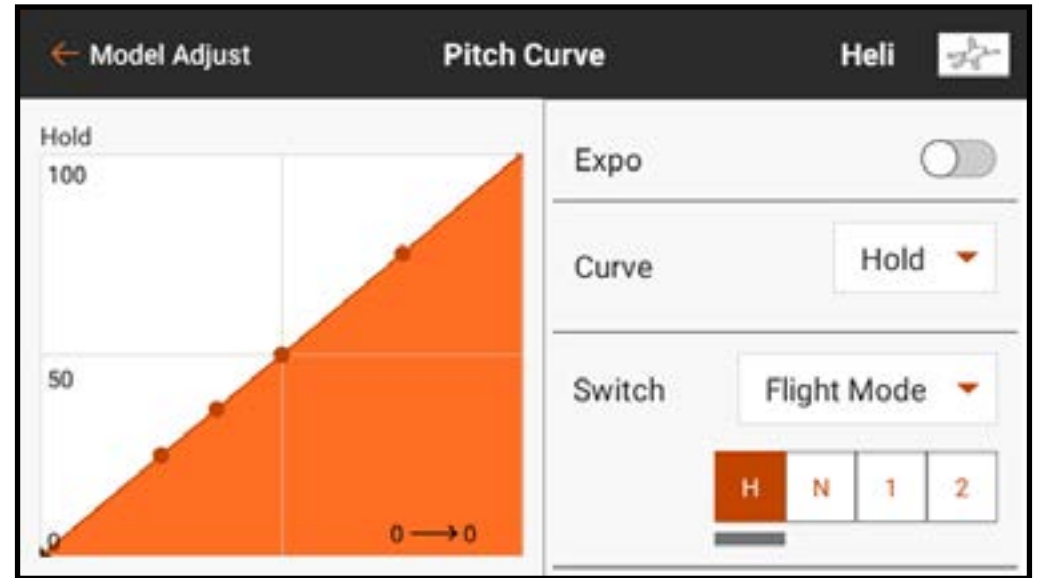
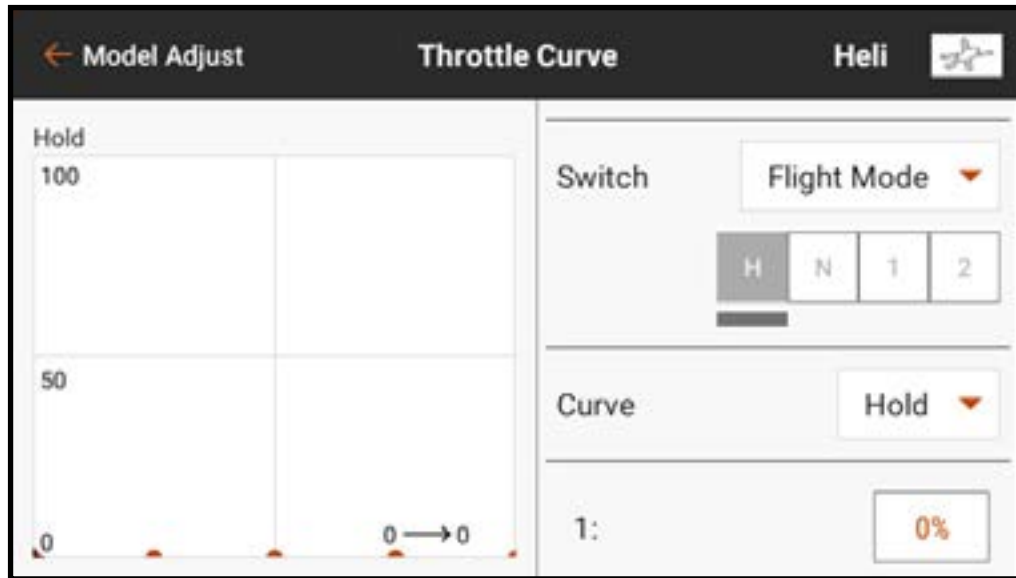

# TRIM SETUP

Use the Trim Setup menu to change the size of the trim step and the trim type.

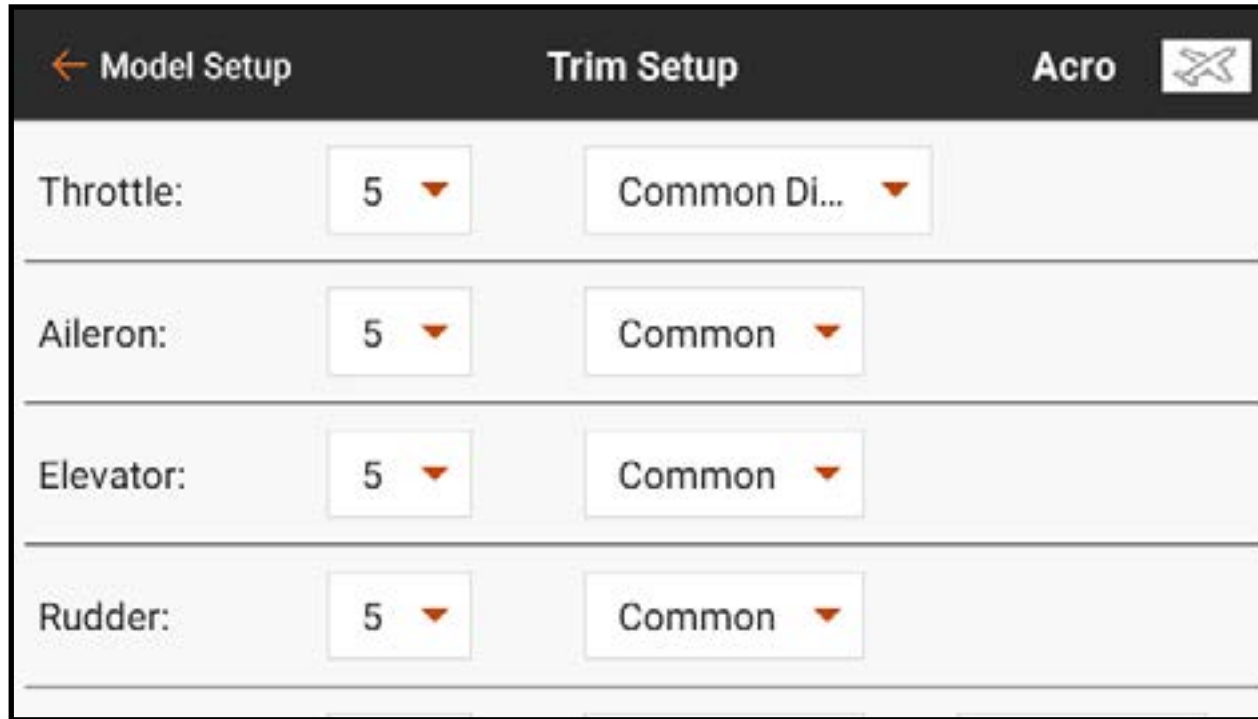

Control	Trim Step	Trim Type
Throttle:	5	Common Di...
Aileron:	5	Common
Elevator:	5	Common
Rudder:	5	Common

The screenshot shows a software interface for trim setup. At the top, there is a navigation bar with a back arrow labeled 'Model Setup', the title 'Trim Setup', and an 'Acro' mode indicator with an airplane icon. Below this, four rows of controls are listed: Throttle, Aileron, Elevator, and Rudder. Each row contains a label, a dropdown menu for the trim step size (all set to '5'), and a dropdown menu for the trim type. The Throttle trim type is 'Common Di...', while the others are 'Common'.

**Trim Step:** Adjusting the trim step value determines how many “clicks” of trim you input each time you press the trim button. Changing the trim step value to 0 disables the trim for the channel.

To change the trim step value:

1. Select the trim channel you wish to change.
2. Select the trim step value and select the click value desired. The default value is 5.

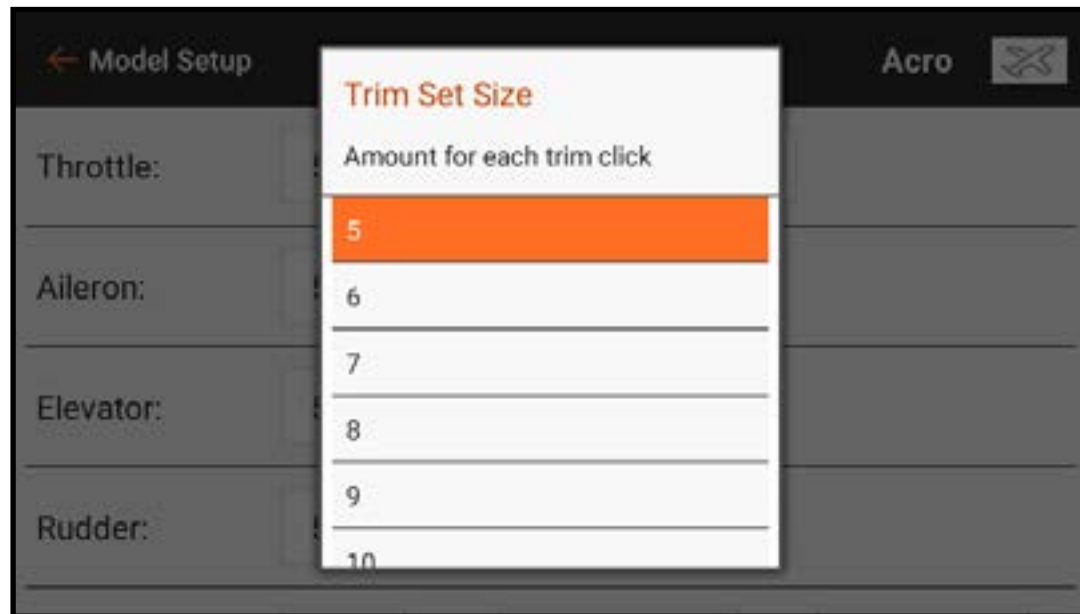

**Trim Type:** The two types are **Common** (default) and **F-Mode**.

Common trim type maintains the same trim values for all flight modes.

F-Mode trim type enables you to save trim values for each individual flight mode.

For example, if an aircraft requires aileron trim in flight mode 1 but not in flight mode 2, use F-Mode trim to add the required trim in flight mode 1 and not affect the other.

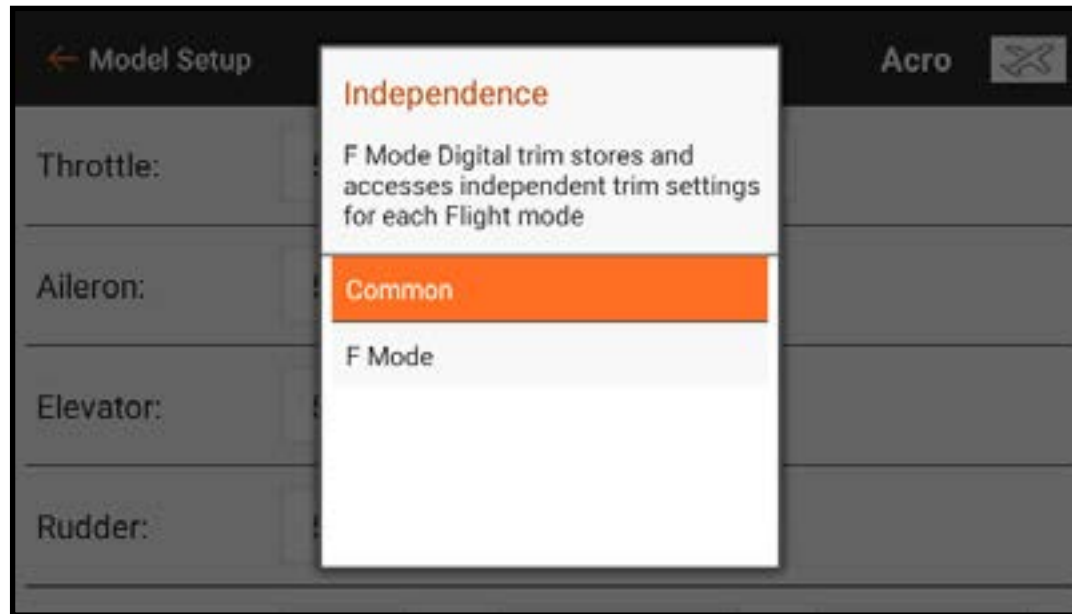

**Trim Assignment:** In some instances, such as airplane model type throttle, trim input may be reassigned to a different location.

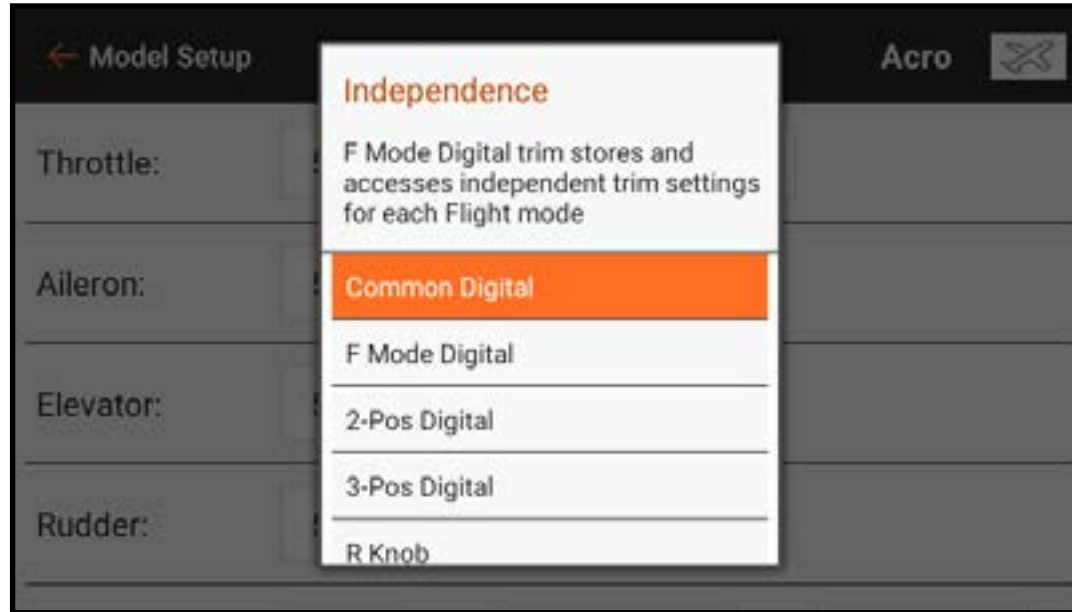



## CROSS TRIMS

**Normal** and **Cross** trim options are available.

Normal trims align with the control stick; for example, the throttle trim is next to the throttle stick.

Cross trims swap the position of the trims; for example, the throttle trim is next to the elevator stick and vice versa.

To change the trim position from Normal to Cross:

1. Scroll to **Trims** at the bottom of the Trim Setup menu.
2. Touch the **Normal** button.
3. Select **Crossed**.

**IMPORTANT:** Crossed trims will cross both sets of trims for both gimbals.

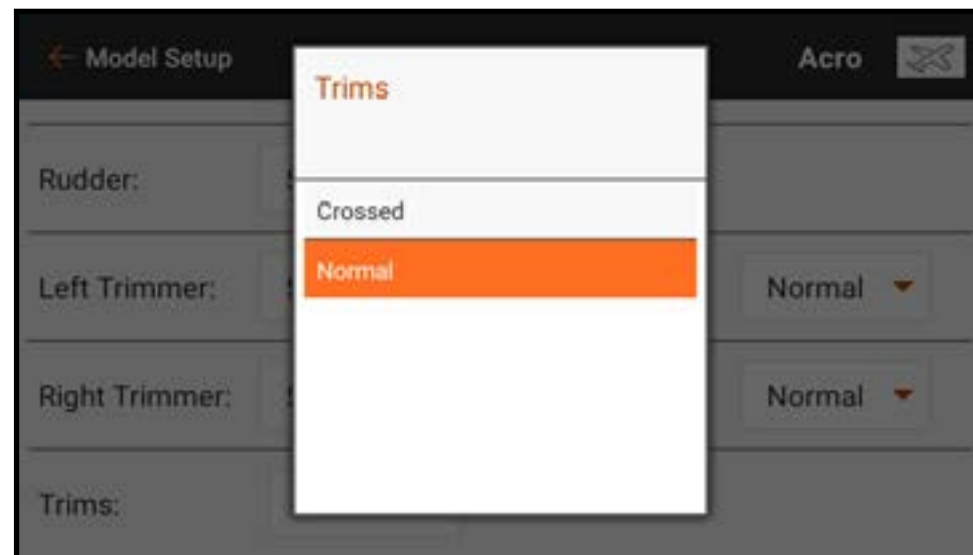
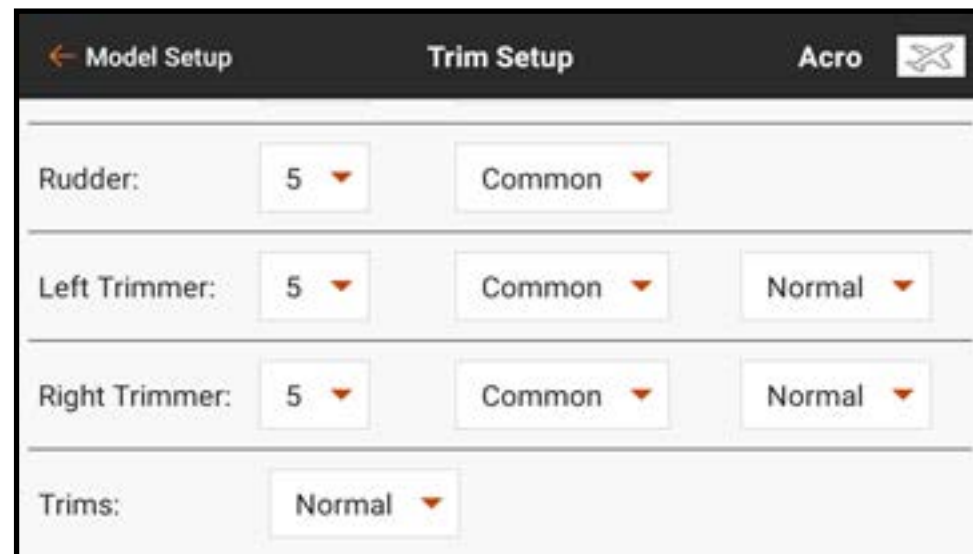

# SYSTEM SETTINGS

The System Settings menu is accessed from any of the main screens by touching the **System Settings** button at the bottom of the screen.

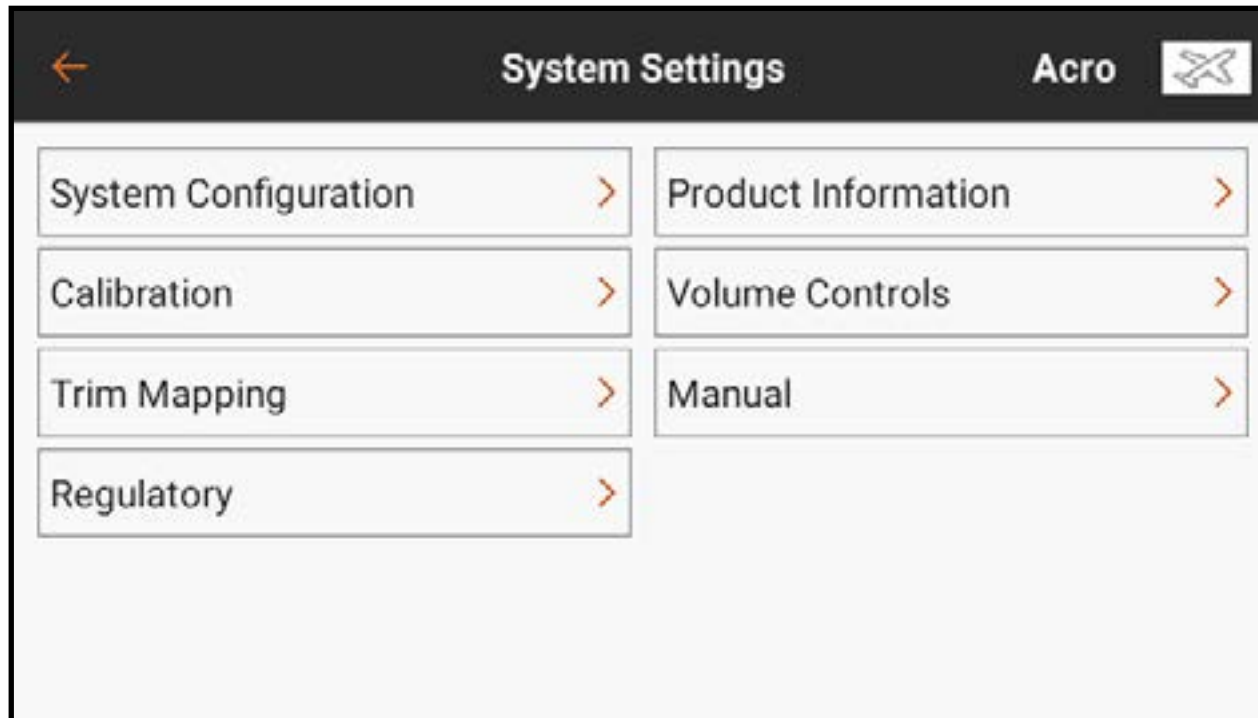

# SYSTEM CONFIGURATION

The System Configuration menu gives the pilot several basic setup options for the iX14.

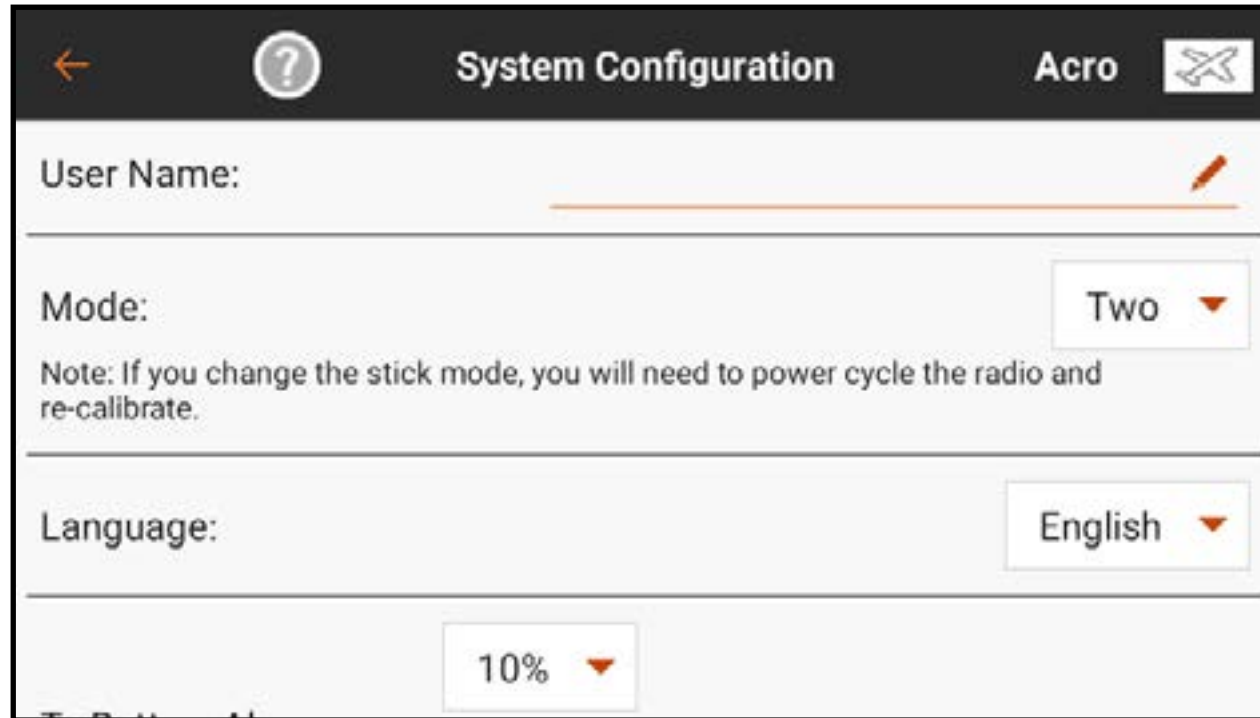

The screenshot shows the 'System Configuration' menu with the following options:

- User Name:** A text input field with a pen icon (✎) for editing.
- Mode:** A dropdown menu currently set to 'Two'. Below it is a note: 'Note: If you change the stick mode, you will need to power cycle the radio and re-calibrate.'
- Language:** A dropdown menu currently set to 'English'.
- Percentage:** A dropdown menu currently set to '10%'.

**User Name:** Touch the pen icon ( ✎ ) to enter the user name in the text field using the on-screen keyboard. Touch **DONE** to save the entry and return to the configuration menu.

**Mode:** Mode refers to how the control stick arrangement. Four modes are available, though most pilots use Modes One or Two. Mode Two is the iX14 default and is preferred by most North American pilots. Changing to Mode One or Three requires a physical change to both transmitter sticks. Refer to the Physical Transmitter Adjustments section for detailed instructions on physically changing the stick layout. The transmitter must have the power cycled before any mode change takes effect. Then recalibrate the transmitter prior to flight. See the Calibration section for more information.

**Language:** Language changes in this menu will change the language within the Spektrum AirWare application.

**Tx Battery Alarm:** The default value for the remaining battery capacity alarm is 10%. This value can be changed by touching the drop down menu and selecting the desired value from the list. Warning type and spoken-text can be changed as well.

**Tx Inactivity Alarm:** Define the time before the inactivity alarm triggers, as well as the type of warning and spoken texts.

**TX Auto sleep (Default 5 min):** If the inactivity alarm continues for the set length of time, the system will automatically go into sleep mode to prevent accidental discharge of the battery.

**Audio Event FIFO on/off (Default off):** Enables the audio events, first in first out feature. This setting plays every audio event in the order they are triggered without audio events 'stepping on or over' each other. If many audio events are active, this setting can cause the system to backlog events which may cause the system to speak for some time, depending on the number of alerts.

**Telemetry Warning Pop Up (Default on):** Enables or disables telemetry warning pop-ups on the transmitter screen. The pop-ups include an option to clear the warning.

**Startup Tone (Default on):** Enables the tone at the startup of the app.

**Dark Mode (Default off):** Sets the default screen tone to dark. This option requires an app restart for any change to take effect.

**Screen brightness:** The slider sets the brightness of the transmitter screen.

**Sleep Mode Screen Trigger (Default double):** Set as Single or Double Click of the power button to quickly access the **Sleep Mode** menu screen.

**RESET SPEKTRUM AIRWARE:** Press the RESET SPEKTRUM AIRWARE button to erase all stored models and load a default model. This action requires a long press to continue to the next warning screen followed by a restart of the system.

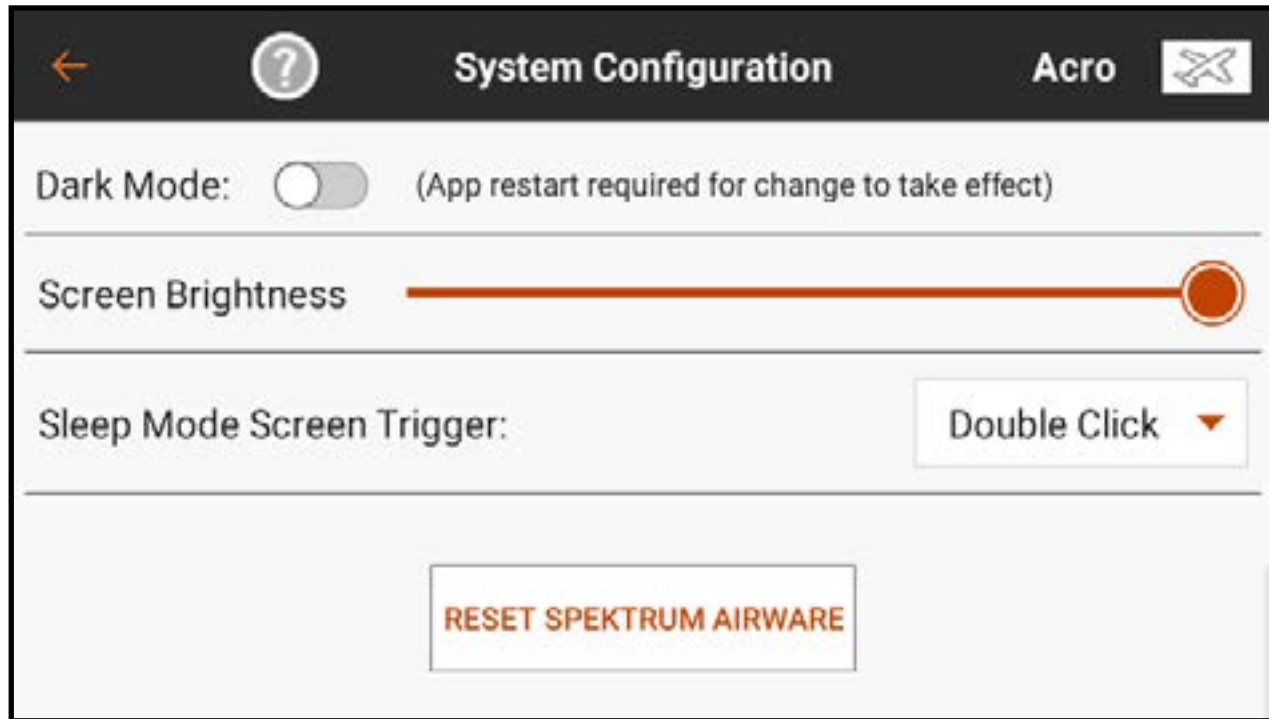

## PRODUCT INFORMATION

The Product Information menu displays the serial number, region, version of the Spektrum AirWare app, firmware version, RF PID and the library version of the transmitter.

Touch the ( ? ) in the top bar to display a QR code linking to spektrumrc.com.

Touch **REGISTER TRANSMITTER** to log in and register the iX14.

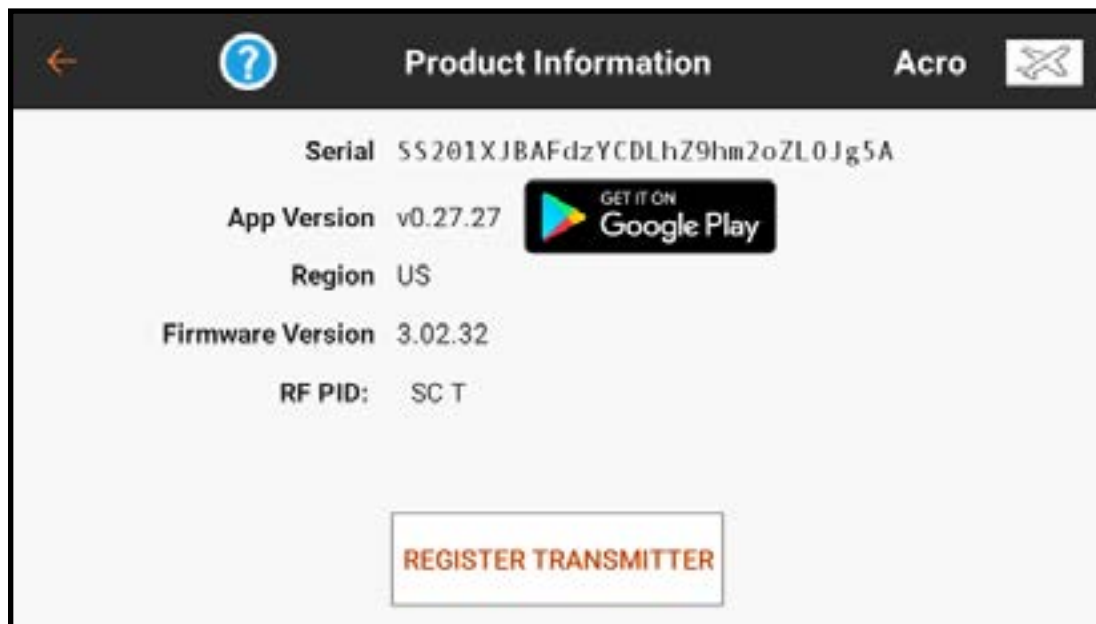



# CALIBRATION

The Calibration menu allows the user to ensure the analog input devices (control sticks, sliders, and knob) are working properly. To complete the calibration procedure, move every control to the extreme and return it to center. The screen shows a graphic representation of each input. The indicator turns green when the range of movement of each control is confirmed. The control must be centered for the indicator to stay green. Select **Save** when all the indicators are green.

Calibration is required any time a stick mode change is performed.

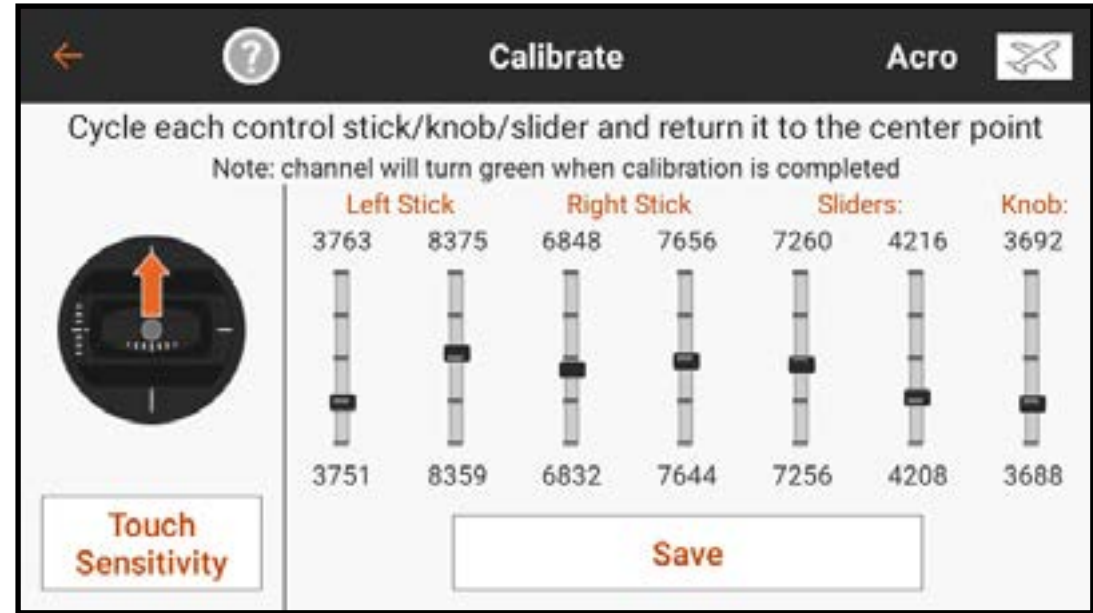

# TOUCH SENSITIVITY

Touch **Touch Sensitivity** in the **Calibration** menu to adjust the switch sensitivity for touch reports.

The small boxes across the top of the menu screen allow you to test the sensitivity of each switch. When you touch the listed switch, the box fills in, indicating a touch.

Adjust the sensitivity level by touching on the value to be adjusted, dragging the slider up or down, and selecting **OK**.

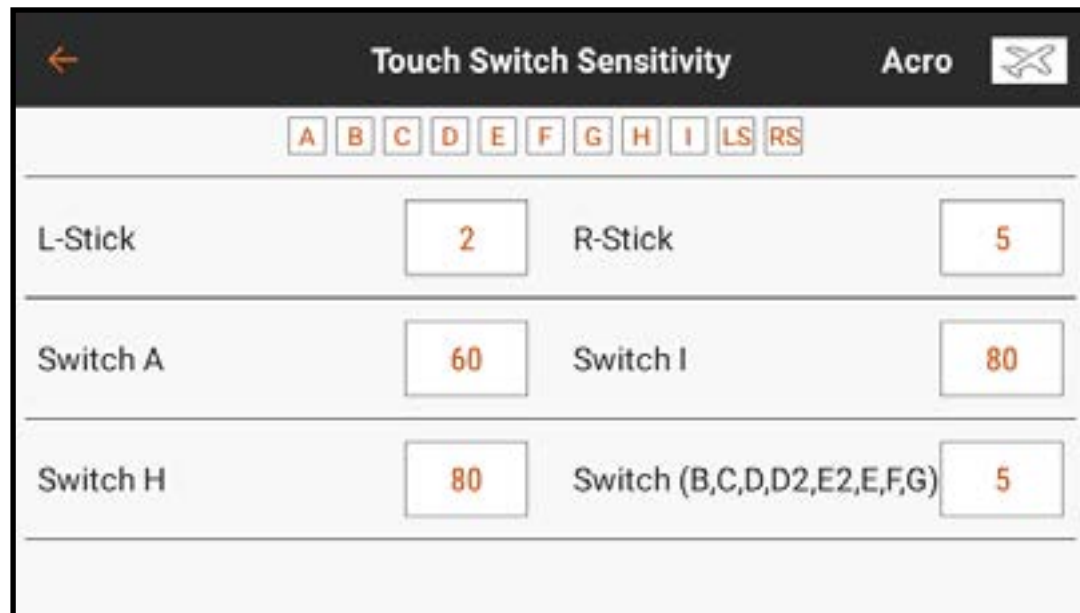

# REGULATORY INFORMATION

The Regulatory screen displays all relevant regulatory information for the iX14.



# TROUBLESHOOTING GUIDE

Problem	Possible Cause	Possible Solution
Can't find expected features	Wrong Model Type or Aircraft type settings	Confirm Model Type and Aircraft Type settings are correct for the desired aircraft
Can't find the Spektrum AirWare app	Shortcut deleted or moved from home screen	Select AirWare app in the App drawer, and drag it to the side to move it to one of the home screens
Battery meter inaccurate	Battery was charged outside of transmitter	With the power off, fully recharge the battery in the transmitter
	Battery allowed to drain completely during use	

Bluetooth won't connect	Bluetooth device not in discoverable mode	Put the device being connected to in discoverable mode
	iX14 already connected to a different Bluetooth device	Disconnect from other Bluetooth devices first. This may require powering off the device or selecting <b>FORGET</b> for that device in the Bluetooth setup menu

Voice reports not functioning	Error in the text to speech engine in Android	Open the settings menu in Android, select Accessibility under System, and select Text-To-Speech output. In this menu confirm the Google text to speech engine is installed and correctly configured
System is running slowly	Third party apps	Keep the number of 3rd party apps to a minimum, and disable app alerts

Aircraft will not Bind (during binding) to transmitter	Transmitter too near aircraft during binding process	Move powered transmitter a few feet from aircraft, disconnect and reconnect flight battery to aircraft
	Aircraft or transmitter is too close to large metal object	Move the aircraft or transmitter away from the large metal object
	The bind plug is not installed correctly in the bind port	Install bind plug in bind port and bind the aircraft to the transmitter
	Flight battery/transmitter battery charge is low	Replace/recharge batteries
	Transmitter is EU version and receiver is DSM2	The iX14 EU version is not compatible with DSM2 receivers

Aircraft will not link (after binding) to transmitter

Transmitter too near aircraft during linking process

Move powered transmitter a few feet from aircraft, disconnect and reconnect flight battery to aircraft

Aircraft or transmitter is too close to large metal object

Move the aircraft or transmitter away from the large metal object

Bind plug left installed in bind port

Rebind transmitter to the aircraft and remove the bind plug before cycling power

Aircraft is bound to different model memory

Select the correct model memory on transmitter

Transmitter may have been bound using different DSM protocol

Bind aircraft to transmitter

Damaged remote receiver or receiver extension

Required remote receiver is not connected



The receiver enters failsafe mode a short distance away from the transmitter	Receiver antenna cut or damaged	Replace or contact Horizon Product Support
	Main and remote receivers too near each other	Install main and remote receivers at least 2 inches (51 mm) apart
Receiver stops responding during operation	Low battery voltage	Completely recharge flight battery
	Loose or damaged wires or connectors between battery and receiver	Do a check of the wires and connection between battery and receiver. Repair or replace wires and/or connectors
Receiver loses its bind	Bind button pressed before transmitter powered on	Rebind by performing binding instructions

Receiver slowly blinking at landing (DSM2 Only)	Loss of power to the receiver during flight	Check battery voltage
	System powered on and connected, then receiver powered off without powering off transmitter	Power off the transmitter when the receiver is powered off

Flight log registers high number of fades, losses or holds or aircraft responds irregularly to controls

Poor signal reception

Reposition remote receivers for improved RF signal path diversity

Electronic feedback

Check for and stop feedback from servos or motor systems to the ESC or receiver

Low power

Check aircraft power draw and increase battery power or decrease power demand by installed systems. Ensure all aircraft batteries are fully charged. Ensure the installed BEC for an electric aircraft is adequate for the power demand

## FAQS

Can I control Spektrum surface equipment with the iX14? **no**

Is it okay to root the android operating system to do custom upgrades and Android configurations? **no**

Can the iX14 use the control sticks to control WiFi or Bluetooth devices? **no**

# 1-YEAR LIMITED WARRANTY

## **What this Warranty Covers**

Horizon Hobby, LLC, (Horizon) warrants to the original purchaser that the product purchased (the “Product”) will be free from defects in materials and workmanship for a period of 1 years from the date of purchase.

## **What is Not Covered**

This warranty is not transferable and does not cover (i) cosmetic damage, (ii) damage due to acts of God, accident, misuse, abuse, negligence, commercial use, or due to improper use, installation, operation or maintenance, (iii) modification of or to any part of the Product, (iv) attempted service by anyone other than a Horizon Hobby authorized service center, (v) Product not purchased from an authorized Horizon dealer, (vi) Product not compliant with applicable technical regulations, or (vii) use that violates any applicable laws, rules, or regulations.

OTHER THAN THE EXPRESS WARRANTY ABOVE, HORIZON MAKES NO OTHER WARRANTY OR REPRESENTATION, AND HEREBY DISCLAIMS ANY AND ALL IMPLIED

WARRANTIES, INCLUDING, WITHOUT LIMITATION, THE IMPLIED WARRANTIES OF NON-INFRINGEMENT, MERCHANTABILITY AND FITNESS FOR A PARTICULAR PURPOSE. THE PURCHASER ACKNOWLEDGES THAT THEY ALONE HAVE DETERMINED THAT THE PRODUCT WILL SUITABLY MEET THE REQUIREMENTS OF THE PURCHASER'S INTENDED USE.

### **Purchaser's Remedy**

Horizon's sole obligation and purchaser's sole and exclusive remedy shall be that Horizon will, at its option, either (i) service, (ii) repair, or (iii) replace, any Product determined by Horizon to be defective. Horizon reserves the right to inspect any and all Product(s) involved in a warranty claim. Service, service and/or replacement decisions are at the sole discretion of Horizon. Proof of purchase is required for all warranty claims. SERVICE, REPAIR OR REPLACEMENT AS PROVIDED UNDER THIS WARRANTY IS THE PURCHASER'S SOLE AND EXCLUSIVE REMEDY.

## **Limitation of Liability**

HORIZON SHALL NOT BE LIABLE FOR SPECIAL, INDIRECT, INCIDENTAL OR CONSEQUENTIAL DAMAGES, LOSS OF PROFITS OR PRODUCTION OR COMMERCIAL LOSS IN ANY WAY, REGARDLESS OF WHETHER SUCH CLAIM IS BASED IN CONTRACT, WARRANTY, TORT, NEGLIGENCE, STRICT LIABILITY OR ANY OTHER THEORY OF LIABILITY, EVEN IF HORIZON HAS BEEN ADVISED OF THE POSSIBILITY OF SUCH DAMAGES. Further, in no event shall the liability of Horizon exceed the individual price of the Product on which liability is asserted. As Horizon has no control over use, setup, final assembly, modification, use or misuse, no liability shall be assumed nor accepted for any resulting damage or injury. By the act of use, setup or assembly, the user accepts all resulting liability. If you as the purchaser or user are not prepared to accept the liability associated with the use of the Product, purchaser is advised to return the Product immediately in new and unused condition to the place of purchase.

## **Law**

These terms are governed by Illinois law (without regard to conflict of law principals). This warranty gives you specific legal rights, and you may also have other rights which vary from state to state. Horizon reserves the right to change or modify this warranty at any time without notice.

## **WARRANTY SERVICES**

### **Questions, Assistance, and Services**

Your local hobby store and/or place of purchase cannot provide warranty support or service. Once assembly, setup or use of the Product has been started, you must contact your local distributor or Horizon directly. This will enable Horizon to better answer your questions and service you in the event that you may need any assistance. For questions or assistance, please visit our website at [www.horizonhobby.com](http://www.horizonhobby.com), submit a Product Support Inquiry, or call the toll free telephone number referenced in the Warranty and Service Contact Information section to speak with a Product Support representative.



## **Inspection or Services**

If this Product needs to be inspected or serviced and is compliant in the country you live and use the Product in, please use the Horizon Online Service Request submission process found on our website or call Horizon to obtain a Return Merchandise Authorization (RMA) number. Pack the Product securely using a shipping carton. Please note that original boxes may be included, but are not designed to withstand the rigors of shipping without additional protection. Ship via a carrier that provides tracking and insurance for lost or damaged parcels, as Horizon is not responsible for merchandise until it arrives and is accepted at our facility. An Online Service Request is available at [http://www.horizonhobby.com/content/service-center\\_render-service-center](http://www.horizonhobby.com/content/service-center_render-service-center). If you do not have internet access, please contact Horizon Product Support to obtain a RMA number along with instructions for submitting your product for service. When calling Horizon, you will be asked to provide your complete name, street address, email address and phone number where you can be reached during business hours. When sending product to Horizon, please include your RMA number,

a list of the included items, and a brief summary of the problem. A copy of your original sales receipt must be included for warranty consideration. Be sure your name, address, and RMA number are clearly written on the outside of the shipping carton.

**NOTICE:** Do not ship lithium batteries to Horizon. If you have any issue with a lithium battery, please contact the appropriate Horizon Product Support office.

## **Warranty Requirements**

**For Warranty consideration, you must include your original sales receipt verifying the proof-of-purchase date.** Provided warranty conditions have been met, your Product will be serviced or replaced free of charge. Service or replacement decisions are at the sole discretion of Horizon.

## **Non-Warranty Service**

**Should your service not be covered by warranty, service will be completed and payment will be required without notification or estimate of the expense unless the expense exceeds 50% of the retail purchase cost.** By submitting the item for service you are agreeing to payment of the service without notification.

Service estimates are available upon request. You must include this request with your item submitted for service. Non-warranty service estimates will be billed a minimum of ½ hour of labor. In addition you will be billed for return freight. Horizon accepts money orders and cashier's checks, as well as Visa, MasterCard, American Express, and Discover cards. By submitting any item to Horizon for service, you are agreeing to Horizon's Terms and Conditions found on our website [http://www.horizonhobby.com/content/service-center\\_render-service-center](http://www.horizonhobby.com/content/service-center_render-service-center).

**ATTENTION:** Horizon service is limited to Product compliant in the country of use and ownership. If received, a non-compliant Product will not be serviced. Further, the sender will be responsible for arranging return shipment of the un-serviced Product, through a carrier of the sender's choice and at the sender's expense. Horizon will hold non-compliant Product for a period of 60 days from notification, after which it will be discarded without liability to Horizon.

# WARRANTY AND SERVICE CONTACT INFORMATION

Country of Purchase	Horizon Hobby	Phone Number/Email Address	Address
United States of America	Horizon Service Center (Repairs and Repair Requests)	servicecenter.horizonhobby.com/ RequestForm/	2904 Research Rd Champaign, Illinois, 61822 USA
	Horizon Product Support (Product Technical Assistance)	productsupport@horizonhobby.com 877-504-0233	
	Sales	websales@horizonhobby.com 800-338-4639	
EU	Horizon Technischer Service	service@horizonhobby.de	Hanskampring 9 D 22885 Barsbüttel, Germany
	Sales: Horizon Hobby GmbH	+49 (0) 4121 2655 100	

## FCC INFORMATION

### **FCC ID: BRWSPMR14000**

This equipment complies with FCC and IC radiation exposure limits set forth for an uncontrolled environment. This equipment should be installed and operated with minimum distance 20cm between the radiator and/or antenna and your body (excluding fingers, hands, wrists, ankles and feet). This transmitter must not be co-located or operating in conjunction with any other antenna or transmitter.

Supplier's Declaration of Conformity

### **Spektrum iX14 14 Channel Aircraft Transmitter (SPMR14000);**

**FCC** This device complies with part 15 of the FCC Rules. Operation is subject to the following two conditions: (1) This device may not cause harmful interference, and (2) this device must accept any interference received, including interference that may cause undesired operation.



**CAUTION:** Changes or modifications not expressly approved by the party responsible for compliance could void the user's authority to operate the equipment.

**NOTE:** This equipment has been tested and found to comply with the limits for a Class B digital device, pursuant to part 15 of the FCC Rules. These limits are designed to provide reasonable protection against harmful interference in a residential installation. This equipment generates, uses and can radiate radio frequency energy and, if not installed and used in accordance with the instructions, may cause harmful interference to radio communications. However, there is no guarantee that interference will not occur in a particular installation. If this equipment does cause harmful interference to radio or television reception, which can be determined by turning the equipment off and on, the user is encouraged to try to correct the interference by one or more of the following measures:

- Reorient or relocate the receiving antenna.
- Increase the separation between the equipment and receiver.
- Connect the equipment into an outlet on a circuit different from that to which the receiver is connected.
- Consult the dealer or an experienced radio/TV technician for help.

Horizon Hobby, LLC

2904 Research Road,

Champaign, IL 61822

Email: [compliance@horizonhobby.com](mailto:compliance@horizonhobby.com)

Web: [HorizonHobby.com](http://HorizonHobby.com)

**IC: 6175A-SPMR14000**

**CAN ICES-3 (B)/NMB-3(B)**

This device contains license-exempt transmitter(s)/receivers(s) that comply with Innovation, Science, and Economic Development Canada's license-exempt RSS(s).

Operation is subject to the following 2 conditions:

1. This device may not cause interference.
2. This device must accept any interference, including interference that may cause undesired operation of the device.



## COMPLIANCE INFORMATION FOR THE EUROPEAN UNION

### **EU Compliance Statement:** **Spektrum iX14 14 Channel Aircraft Transmitter (SPMR14000);**

Hereby, Horizon Hobby, LLC declares that the device is in compliance with the following: EU Radio Equipment Directive 2014/53/EU; RoHS 2 Directive 2011/65/EU; RoHS 3 Directive - Amending 2011/65/EU Annex II 2015/863.

The full text of the EU declaration of conformity is available at the following internet address: <http://www.horizonhobby.com/content/support-render-compliance>.

**NOTE:** This product contains batteries that are covered under the 2006/66/EC European Directive, which cannot be disposed of with normal household waste. Please follow local regulations.

# Wireless Frequency Range and Wireless Output Power

## **Control:**

Frequency Band: 2402-2478MHz

Max EIRP: 20 dBm

## **Trainer:**

Frequency Band: 2404-2478MHz

Max EIRP: 3 dBm

## **2.4 GHz WiFi:**

Frequency Band: 2412-2462MHz

Max EIRP: 19.5 dBm

## **5GHz WiFi:**

Frequency Band: 4900-5845MHz

Max EIRP: 15.5 dBm

## **Bluetooth:**

Frequency Band: 2404-2480MHz

Max EIRP: 10 dBm

## **EU Manufacturer of Record:**

Horizon Hobby, LLC  
2904 Research Road  
Champaign, IL 61822 USA

## **EU Importer of Record:**

Horizon Hobby, GmbH  
Hanskamring 9  
22885 Barsbüttel Germany

## **WEEE NOTICE:**

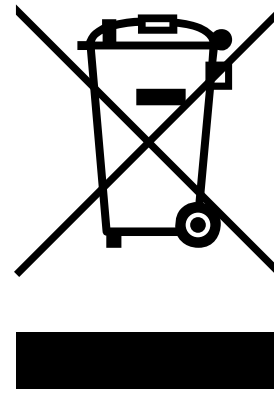

This appliance is labeled in accordance with European Directive 2012/19/EU concerning waste of electrical and electronic equipment (WEEE). This label indicates that this product should not be disposed of with household waste. It should be deposited at an appropriate facility to enable recovery and recycling.



**E328**

[< TOC](#)

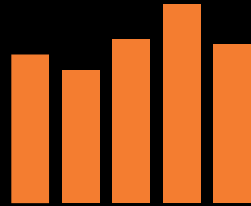

# SPEKTRUM®

© 2022 Horizon Hobby, LLC.

DSMX, the DSMX logo, Spektrum AirWare and the Horizon Hobby logo are trademarks or registered trademarks of Horizon Hobby, LLC. The Spektrum trademark is used with permission of Bachmann Industries, Inc. Android is a trademark of Google Inc. The Bluetooth® word mark and logos are registered trademarks owned by Bluetooth SIG, Inc. and any use of such marks by Horizon Hobby is under license. The WiFi logo is a registered trademark of WiFi Alliance.

All other trademarks, service marks and logos are property of their respective owners.

US 9,930,567. US 10,419,970. US 7,391,320. Other patents pending.