

  
SUPER FLYING MODEL  
MANUFACTURE

# SUPER DECATHLON

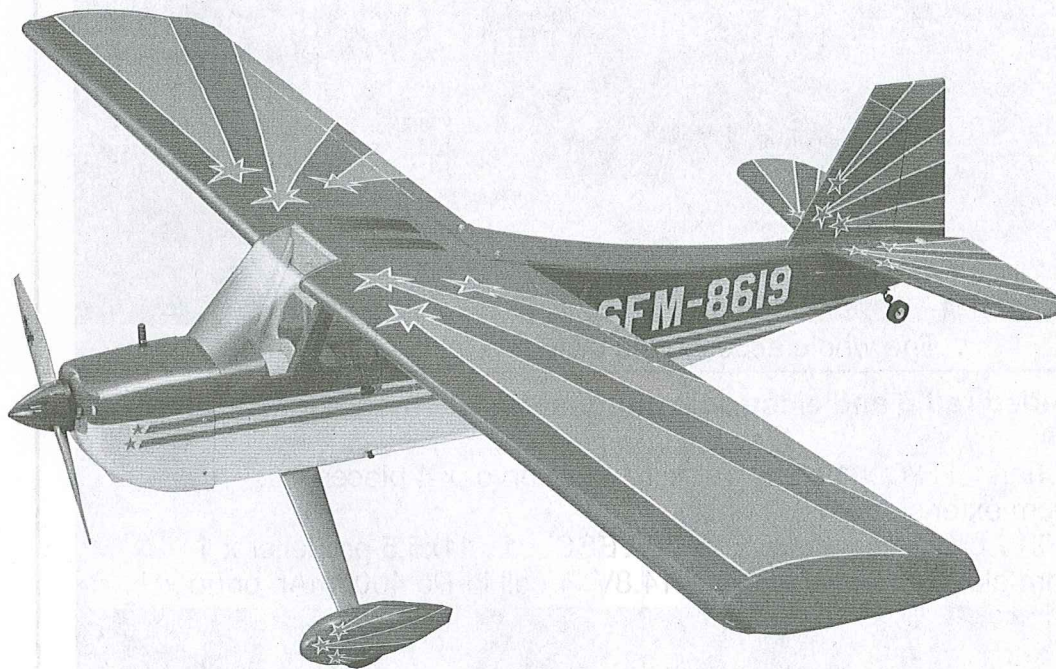

**No. 8619**

## SPECIFICATIONS

WING SPAN: 1608mm

LENGTH: 1145mm

WING AREA: 39.8dm<sup>2</sup>

WEIGHT: 2450g

RADIO: 4CH

INSTRUCTION MANUAL

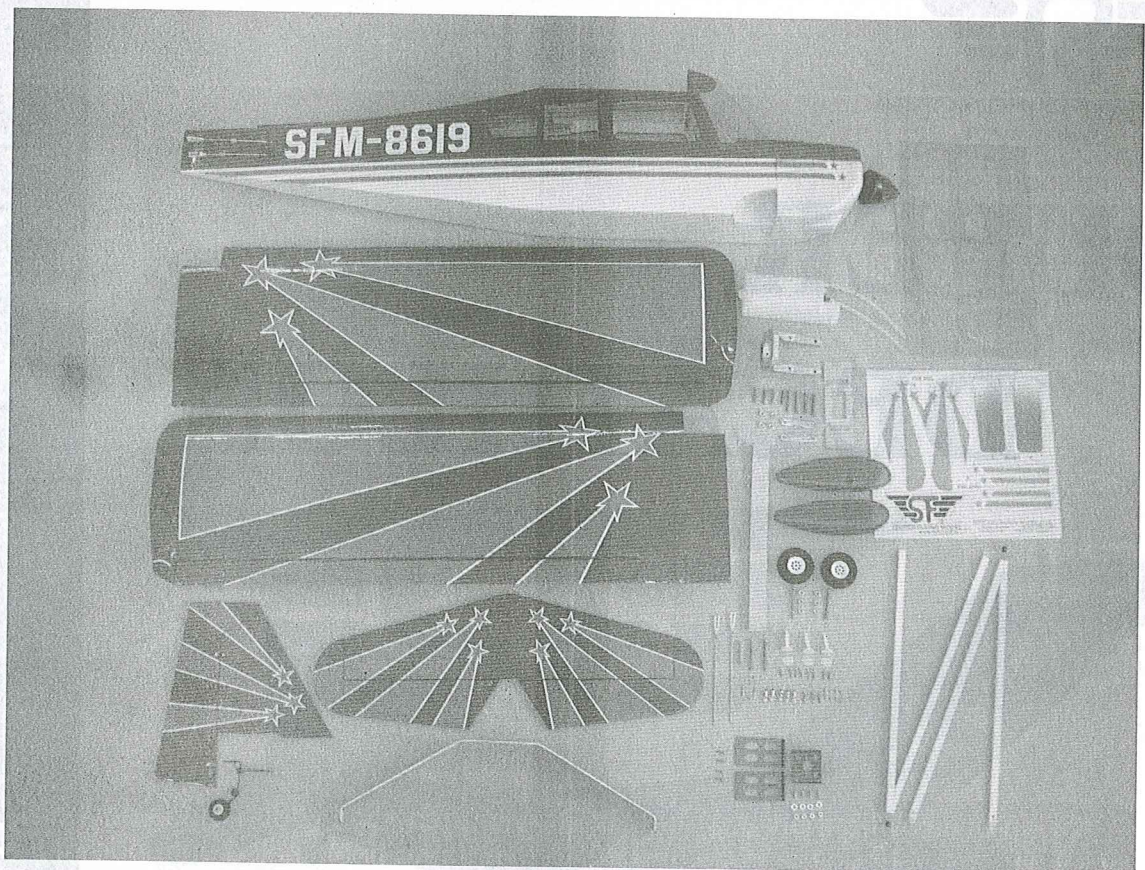

The whole accessories including in this kit.

**Recommended radio and electronic equipment (Not included in kit):**

Accessories:

**For GP:** 4 channel R/C x 1 / receiver x 1 / 45g servo x 4 pieces  
30cm extension x 1

**For EP:** 950KV brushless motor x 1 / 70A ESC x 1 11x5.5 propeller x 1  
5mm aluminum adaptor x 1 / 14.8V 4-cell Li-Po 4000mAh or up x 1

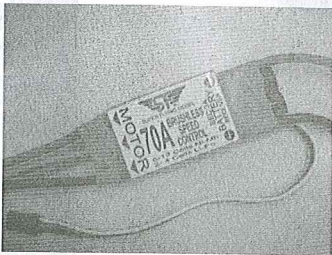

#2423 70A ESC

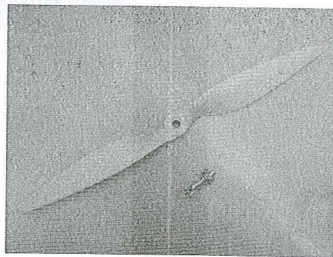

#1003-11x5.5 11 x 5.5 propeller  
#1001-A5.0 ALU nut for 5.0mm shaft

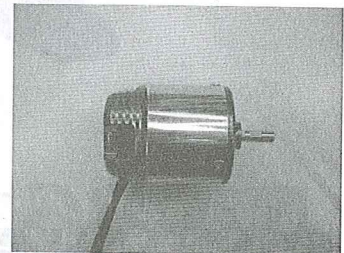

#2200-9-950 950kv  
brushless motor

**Tools and suppliers needed (not included in kit)**

1.5mm hex wrench  
Cross wrench  
Curved scissors  
Clip  
Tissue  
Nipple pliers

Hobby knife  
Reamer  
Sanding paper  
Iron  
Ruler  
Marker

Phillips driver  
1.3mm/1.5mm/ 2mm driller  
Instant glue  
Tap  
Epoxy  
Foam glue

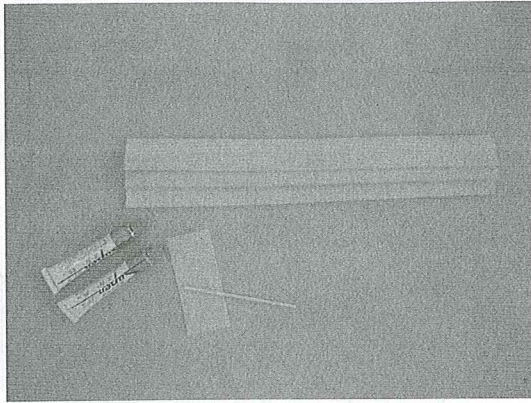

Carefully remove the three individual wing joiners from the parts bag. If necessary, sand gently to remove any rough edges. Apply epoxy to both sides of one of the wing joiners. Place the epoxied wing joiner on top of one of the two remaining wing joiners. Stack the remaining wing joiner on top of the epoxied wing joiner. Align the upper and lower edges of all three wing joiners.

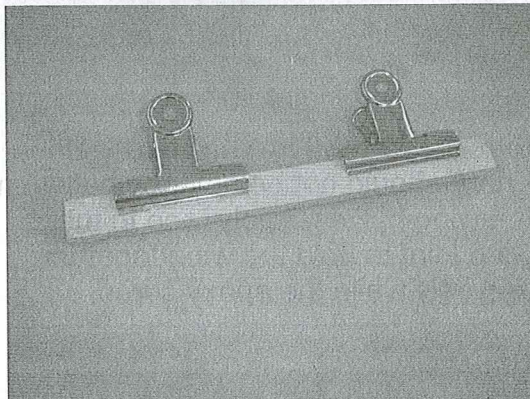

Clamp the three joiners together using clips. Make sure the joiners remain aligned and the clamps are firmly attached. Allow the epoxy to cure completely prior to removing the clamps.

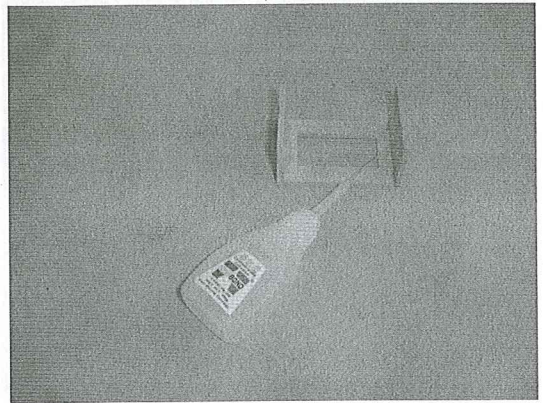

Remove the aileron servo tray and the two aileron tray supports from the parts bag. Position the aileron servo tray in place as shown and lightly spread instant glue along the joint between the servo tray and supports. Make sure the aileron servo supports and the servo tray remain perpendicular to one another. Allow the glue to dry completely before proceeding to the next step.

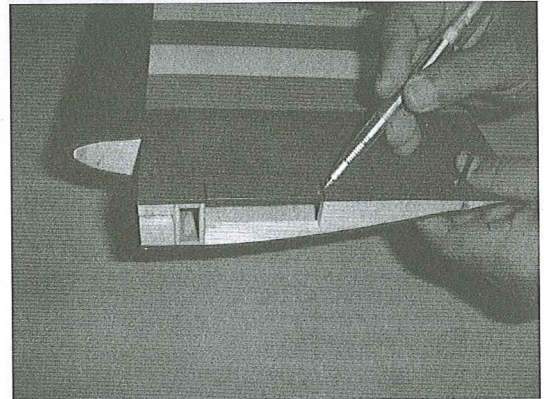

Place the wing halves on the flat surface so the bottoms are facing downward. Using marker, place a mark at the leading edge and trailing edge of the servo bay on each wing half. These marks will be utilized as a guide when cutting the holes for the aileron servo tray.

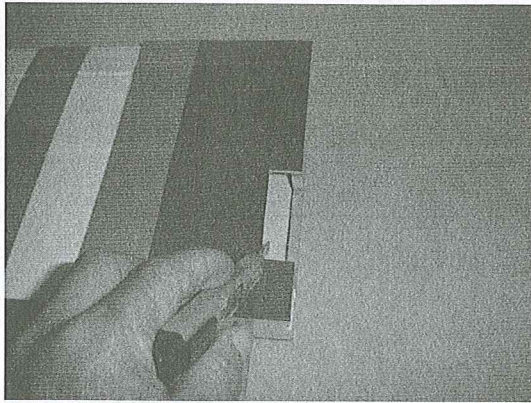

Using the sharp hobby knife carefully cut through the balsa wood and the covering along the marks (made in last step). Remove the excess balsa from the hole.

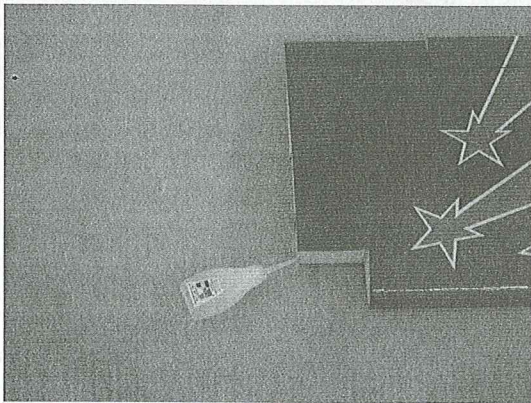

Use instant glue to secure the dowel on the main wing.

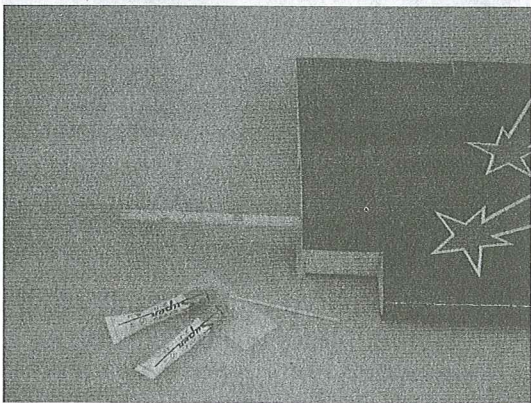

Spread epoxy on both sides of wing joiner. Insert wing joiner into one of the wing panels.

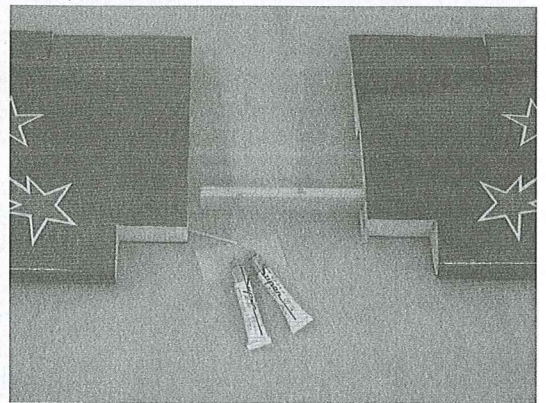

Carefully slide the two wing halves together, ensuring they are accurately aligned.

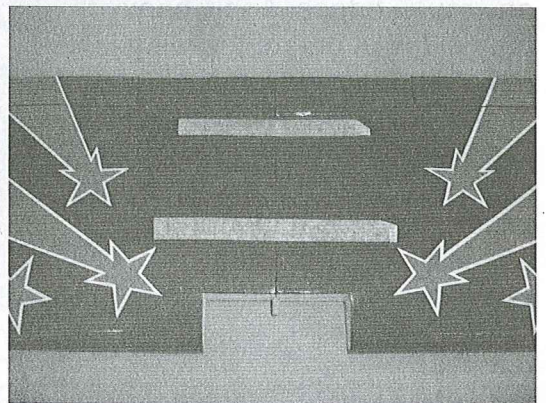

Firmly press the two halves together. There should not be any gap between the wing halves. Apply tape to the wing joint to hold the wing together securely while the epoxy cures.

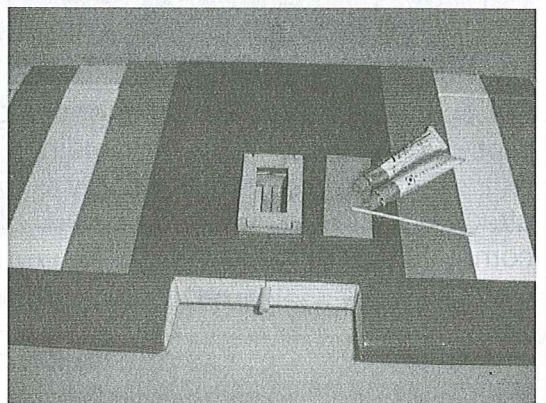

Mix a small amount of epoxy to glue the servo into the wing.

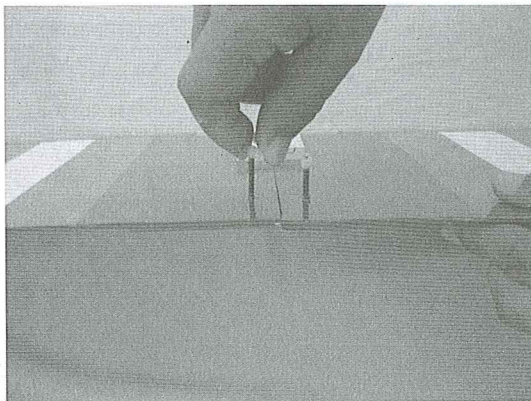

Remove the two aileron horns from the plastic parts tree. Thread the aileron horns onto the aileron torque rod until the rod is flush with the aileron horn.

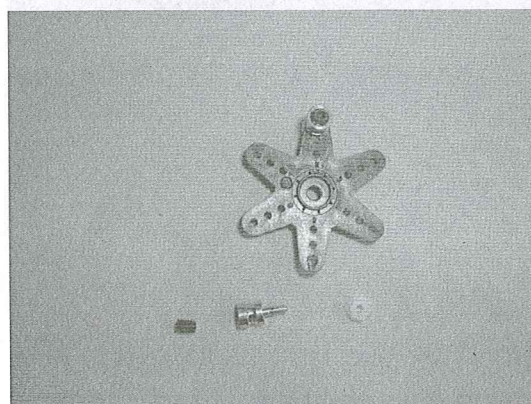

Take out the adjustable rod stand, M3 hex screw and plastic nut from the hardware bag. Drill a 2mm hole on the servo arm. Install the hex screw on the stand. Use 1.5 hex pliers to secure the plastic nut on the stand just like the picture. Make sure the rod stand can move freely.

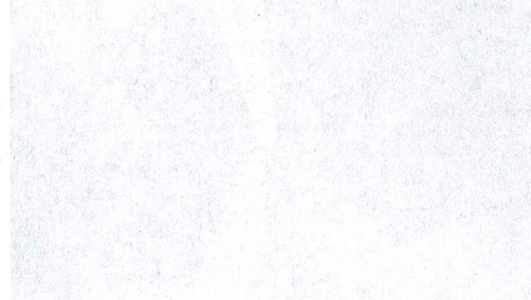

Try to fit the horizontal servos in place. The servos should be in the location shown in the picture. The servo should be in the location shown in the picture.

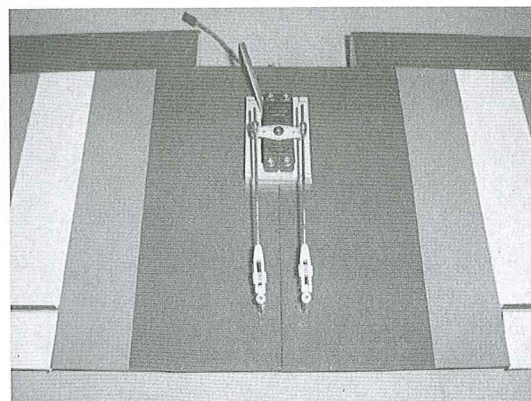

Install the rubber servo grommets and eyelets in the aileron servo and place the servo into the aileron mount. Using a pencil, mark the position of the four servo mounting holes. Remove the servo from the aileron tray. Using 1.5mm drill bit, drill the four mounting holes as marked. Place the aileron servo back in its mount and secure it in place using the four screws included with the servo. Screw a clevis onto the threaded end of each rod. Attach the clevises onto their respective aileron horns. Using a small silicone tube to firmly hold the clevises for avoiding taking off from horn when landing. Center the servo horn and install the other end of the rod into the adjustable rod stand. Using 1.5mm hex wrench to secure the servo arm.

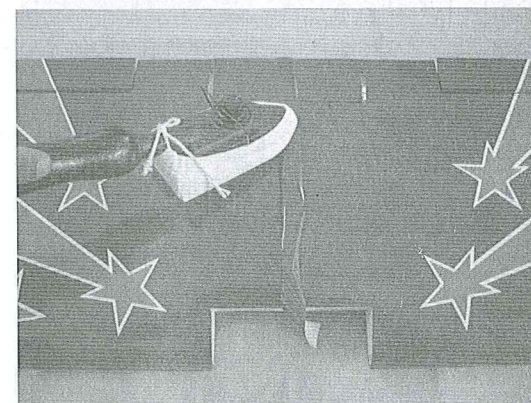

When the wing center joint is completely dry, apply the included trim tape to cover the center joint and iron on.

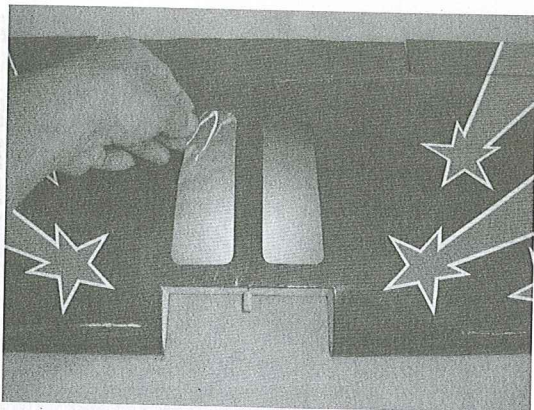

Apply the decorative window decal on the top of main wing.

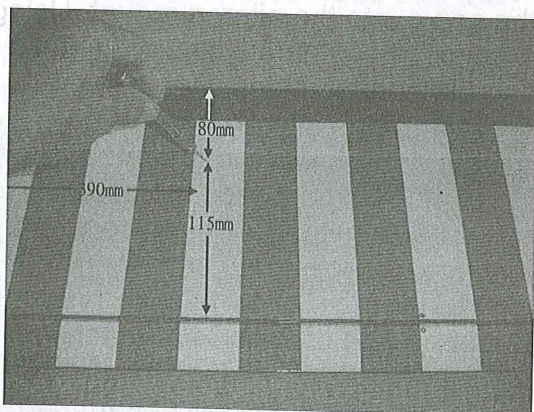

Try to find two small blocks inside the main wing (it's on the center part of the main wing). Using pencil to mark the position on its center point. Using 1.3 mm driller, drill a hole on the marking point. Please refer to the measurement in the picture.

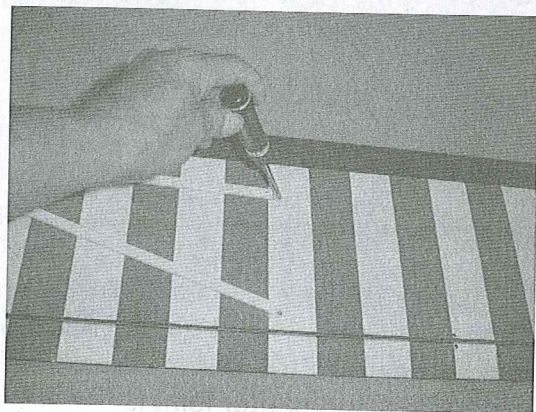

Place the wing struts on the main wing. Using 2x6mm-tapping screws to secure the struts in place.

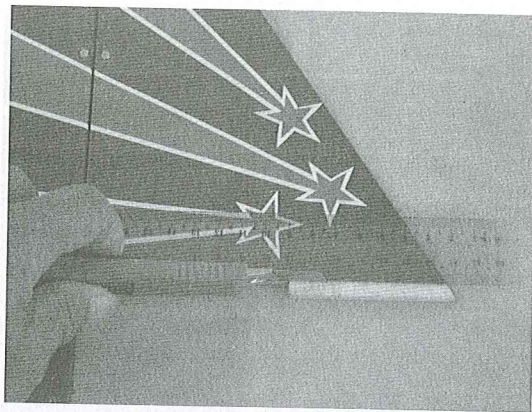

Using pencil to mark one line of 6mm high from the bottom of the vertical. Using hobby knife to cut away the OPP covering inside the marking line.

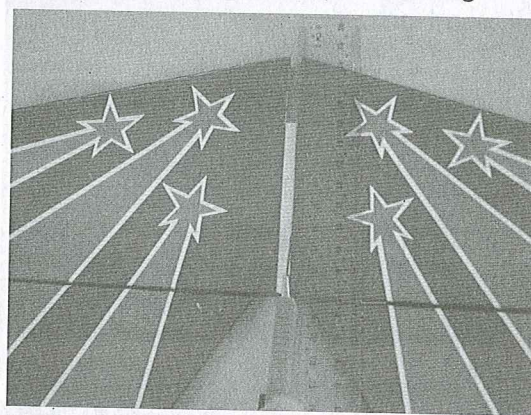

Using ruler and pencil to mark 6mm area on the center part of the horizontal stabilizer. Using hobby knife carefully cut away the covering inside the marking area. (Don't cut into the wood)

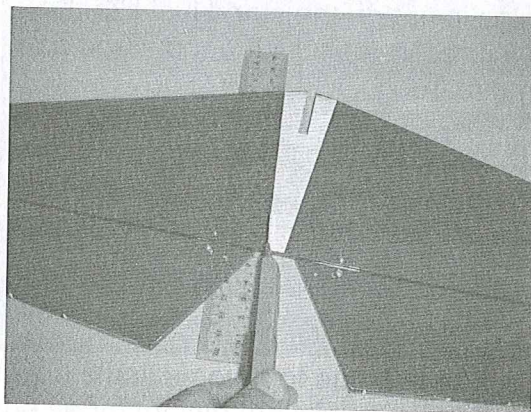

Try to fit the horizontal stabilizer into the fuselage. When satisfy the location, use pencil to mark the contacting area.

Using hobby knife carefully cut away the covering inside the marking area. (Don't cut into the wood.)

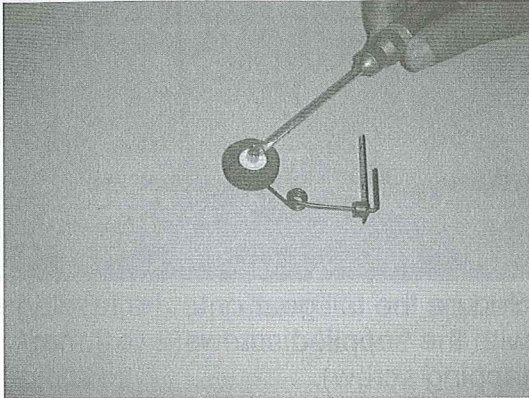

Install the tail wheel onto the tail gear and secure it with the supplied tail wheel collar and screw.

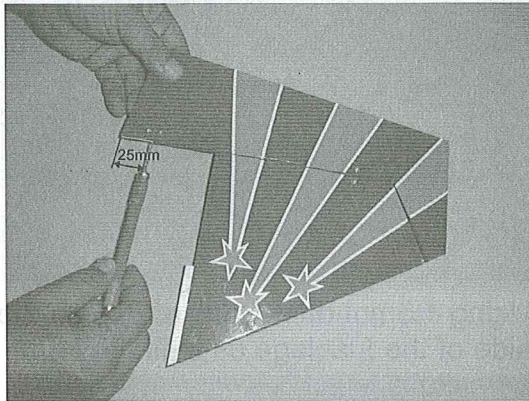

Take the tail wheel assembly and place it in the location to be installed on the bottom side of horizontal stabilizer. The tail wheel's guide wire will be installed into the rudder. Mark the position where the hole is to be drilled into the leading edge of the rudder for the steering rod. Remove the horizontal stabilizer. Using 2.0mm drill, drill into the exact center of the leading edge of the rudder to accept the tail wheel guide wire.

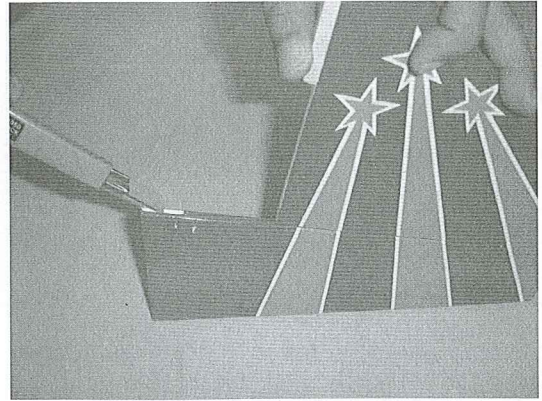

Using hobby knife to cut one slot for the tail gear.

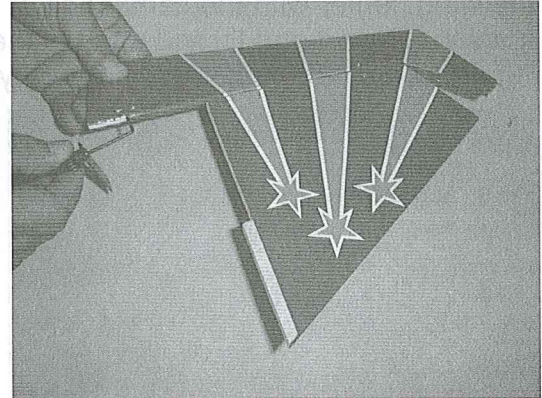

Install the tail gear assembly to the horizontal stabilizer.

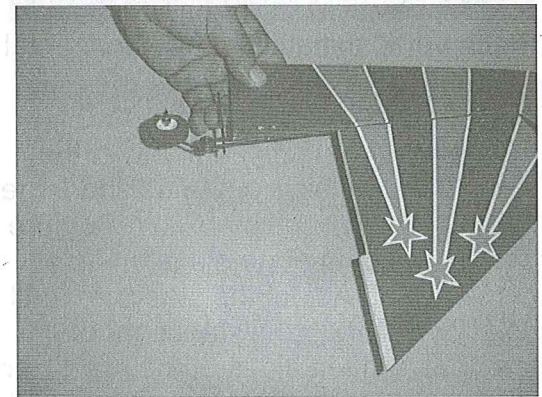

Drop some instant glue to secure the tail gear inside the slot.

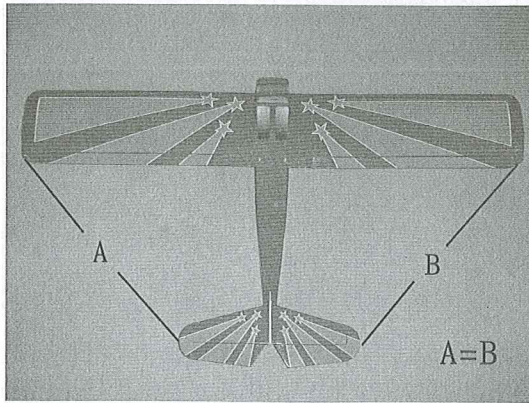

Place the wing onto the wing saddle of the fuselage, approximately aligning the wing center with the center line of fuselage. Insert and thread each of the wing bolts into the fuselage temporary.

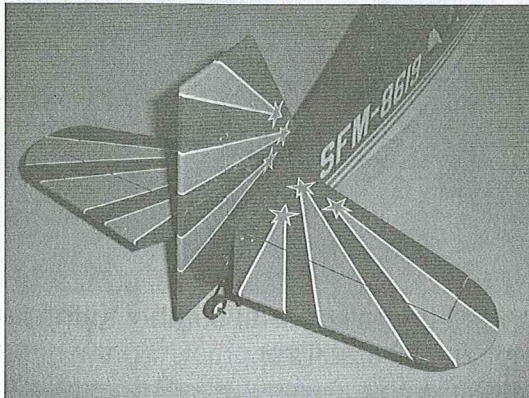

Place vertical stabilizer and horizontal stabilizer on the fuselage. Align the horizontal stabilizer by measuring from a fixed point on the wing to the outside of the trailing edge tip of the horizontal stabilizer. Be sure that the leading edge stays on its center mark. Adjust the stabilizer until you have an equal distance on both the right and left sides of the stabilizer to the wing. Use epoxy to glue the tail wing in place. Remove the main wing when the glue dries completely.

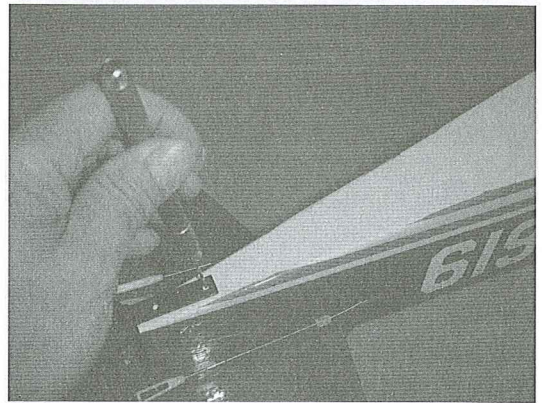

Secure the tail gear onto the fuselage with the supplied screws (2.6x8 mm tapping screw).

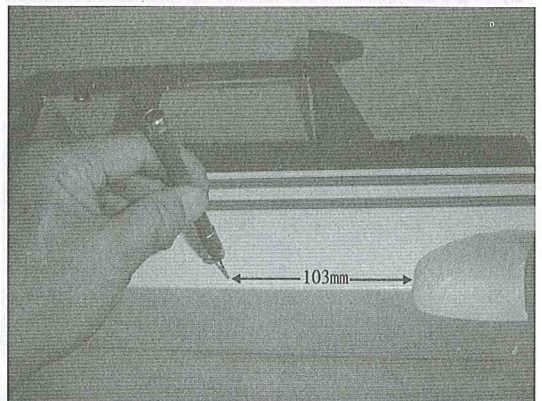

Using 1.5mm driller, drill a hole on the side of the fuselage as indicated on the picture.

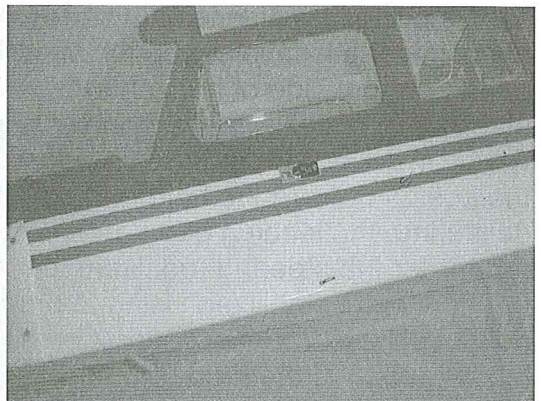

Secure one L screw into this hole.



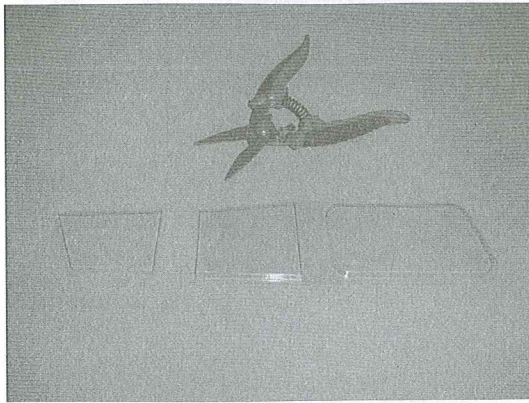

Using hobby scissors to cut and trim the window set as indicated in the picture.

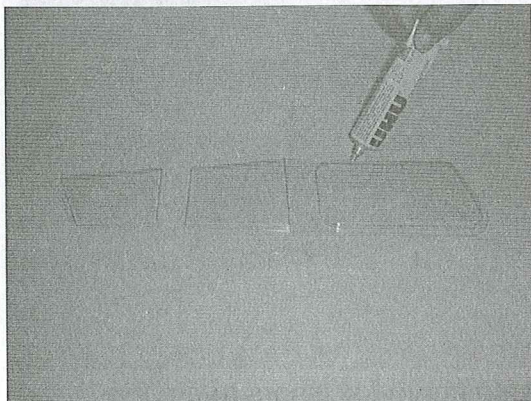

Spread some glue around the edge of the windows.



Glue the windows in place.

## FOR THE GP VERSION



Try to locate the canopy in place and use tape to fix it.

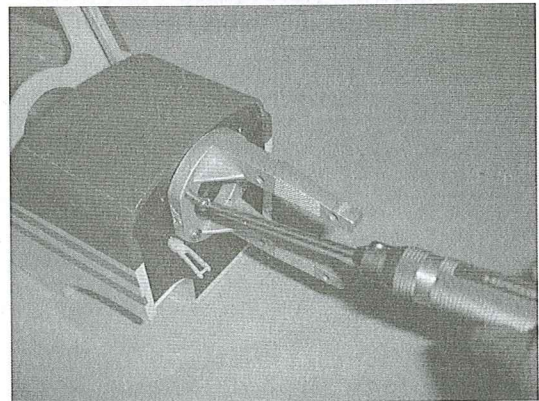

Secure the engine mount with the supplied screws (M4x25mm screws X 4 pieces) as indicated in the picture.

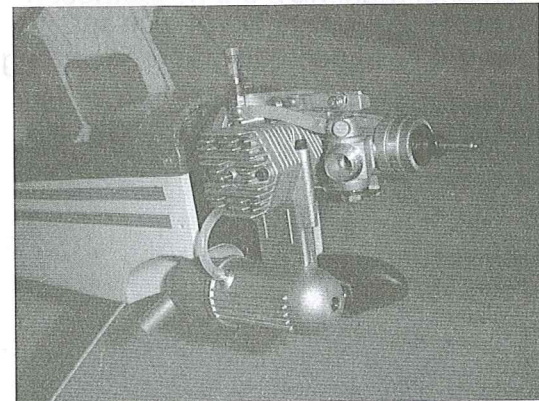

Secure the engine on the engine mount. Install the muffler per the instructions included with the engine. Connect the fuel tube. Connect the vent tube from the fuel tank to the pressure fitting, or nipple, on the muffler. The remaining tube should be

attached to the carburetor fuel inlet nipple.

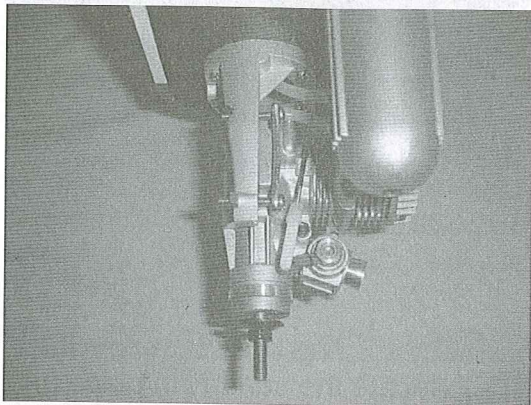

Attach the clevis to the throttle lever of the carburetor (using M4 x 30mm screws x 4 pieces).



Place the top engine cowl on the working table. Use hobby scissors to trim the cowl according to the marking line

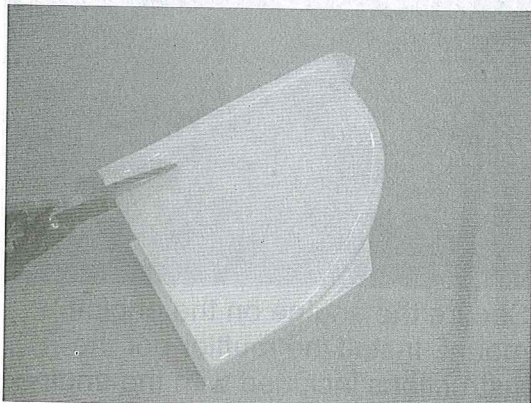

Place the bottom engine cowl on the working table. Use hobby scissors to trim the cowl according the marking line.

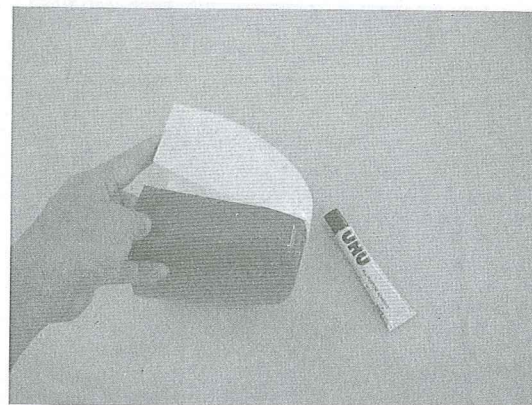

Glue the top and bottom engine cowls together

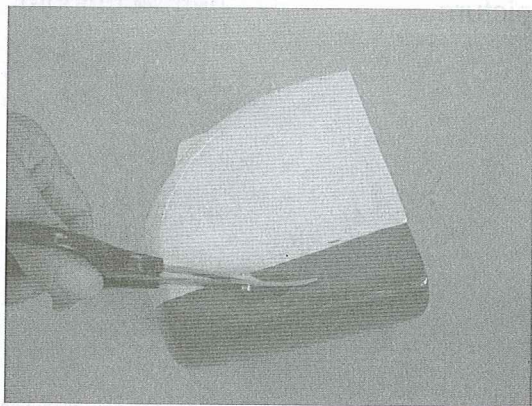

Use curved scissors to cut the openings according to the pre-marking lines.



Try to fit the cowling over the engine. When satisfy the location, use tape to hole the cowl in position, then mark two screw hole locations on each side of the cowl.

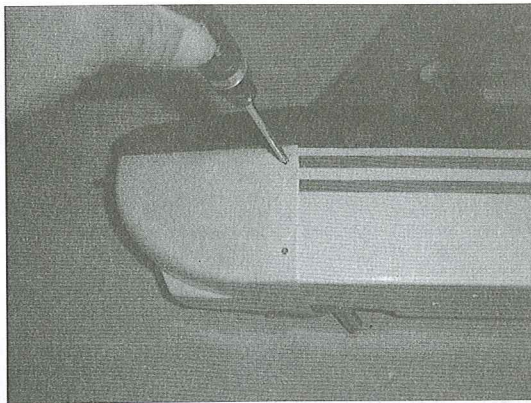

Secure the cowling with 2x6mm tapping screws.

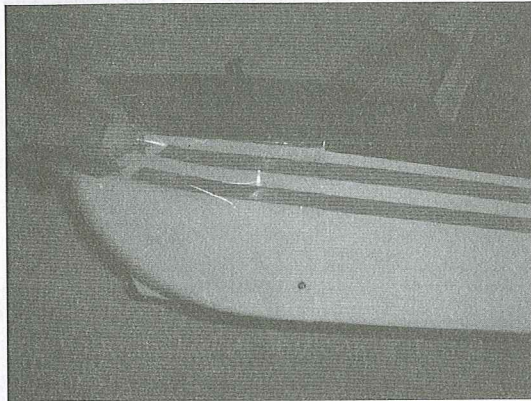

Apply the trim film to the cowling.

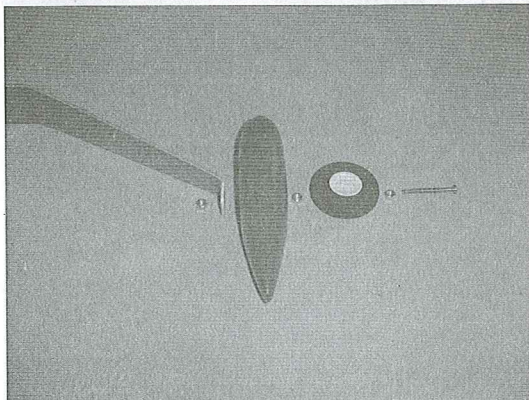

Take out the landing gear accessories  
M4 x 40mm screw x 1 piece  
4mm nuts x 3 pieces  
from the hardware bag.

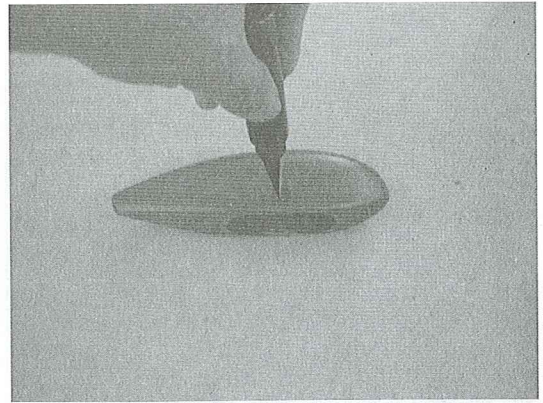

Place the wheel pant on the working table. There is a "dimple" in each side. Use these dimples as a guide to drill a 4mm hole completely through the wheel pant using reamer.

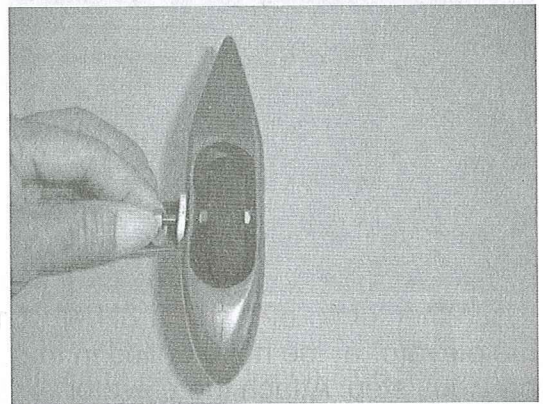

Using M4 nut to secure the wheel pant assembly on the aluminum landing gear. Repeat the same procedure on another side of wheel pant assembly.

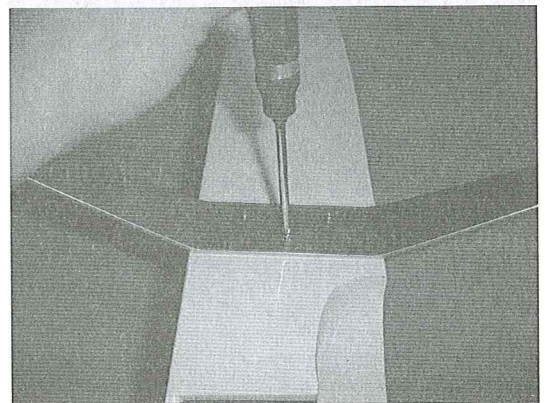

Using 3 x 12mm screws to secure the aluminum landing gear set on the bottom of the fuselage.

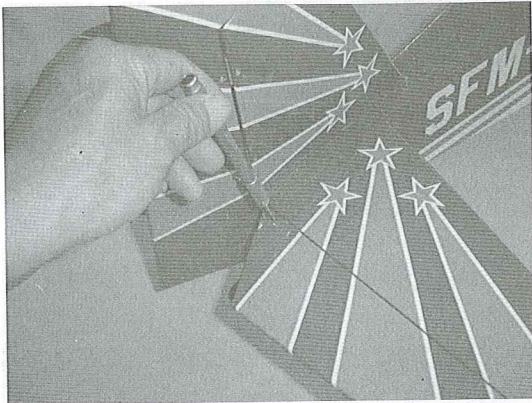

Use driller to drill 2mm hole on the elevator.

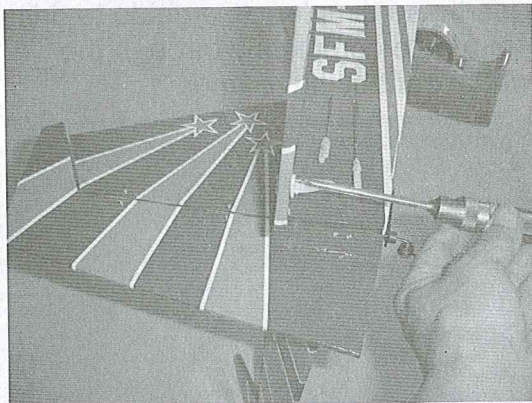

Place the center of the control horn on the elevator at the hole drilled in the previous step. Attach the elevator control horn using the hardware provided (M2 x 12mm screws x 2 pcs) and fasten in place using a Phillips screwdriver.

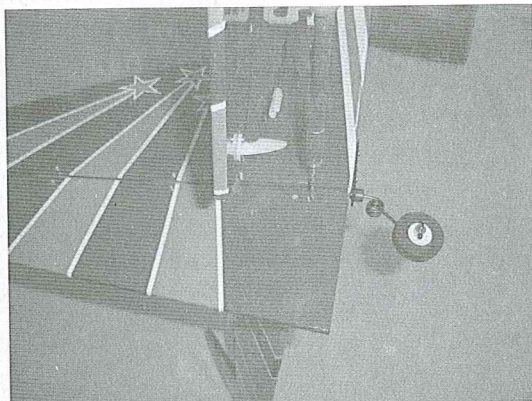

Drill 2mm holes on the rudder.



Repeat the same procedure to attach the rudder control horn on the rudder.

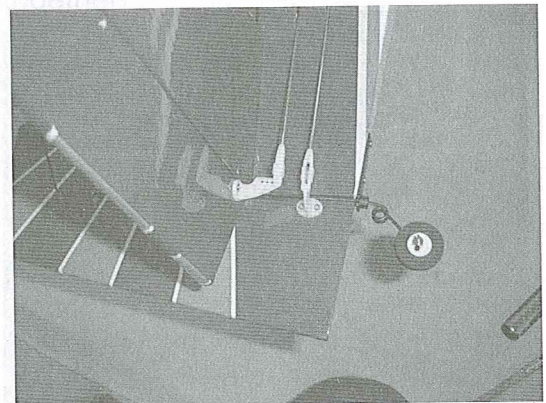

Connect the linkage sets with the control horns.

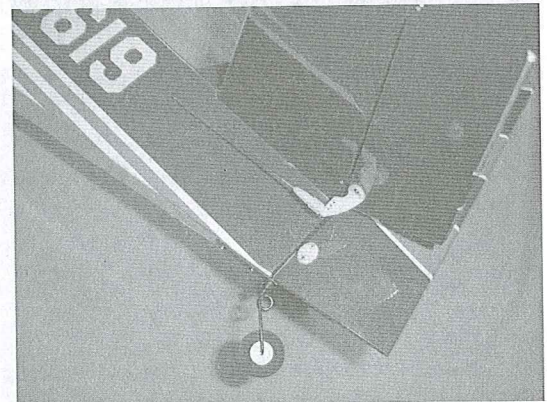

Connect the left elevator rod linkage with the control horn.

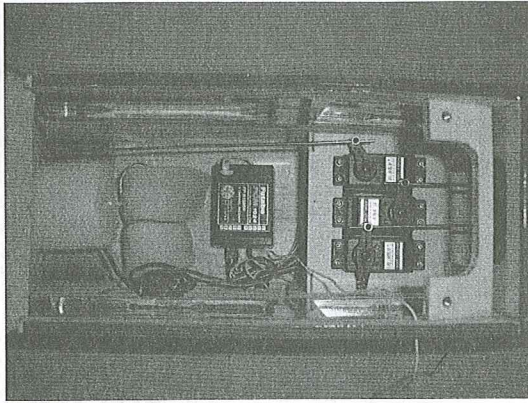

Install the servos for rudder, elevator and throttle. Please note the servos must be in neutral position. Install the battery pack.

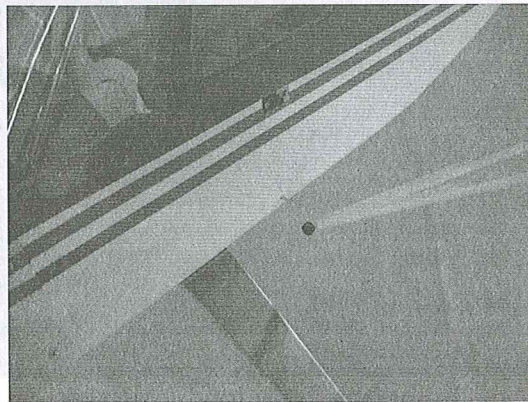

Insert the plastic ring into the strut hole.

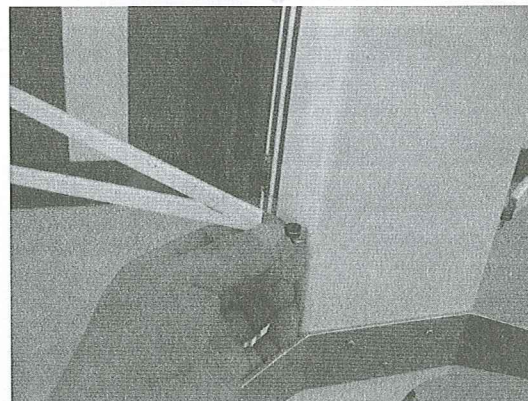

Connect the plastic ring with the L screw on the side of the fuselage.

## FOR THE EP VERSION

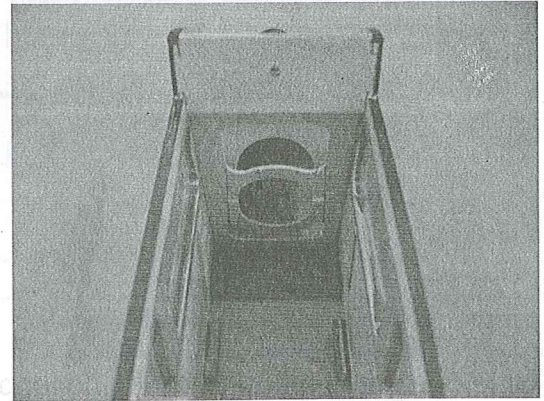

Use hobby knife to cut off the planking according to the laser-cutting lines.

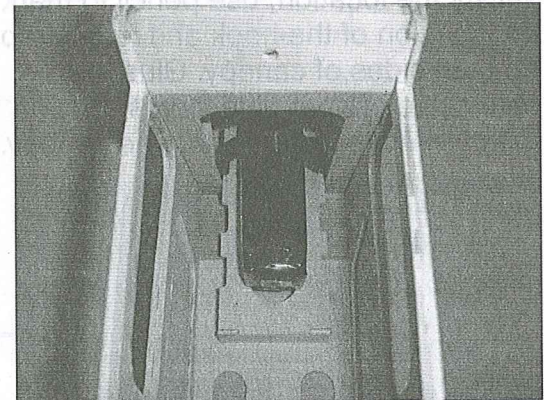

Glue the battery tray inside the fuselage. Secure the battery using the hook and loop strap.

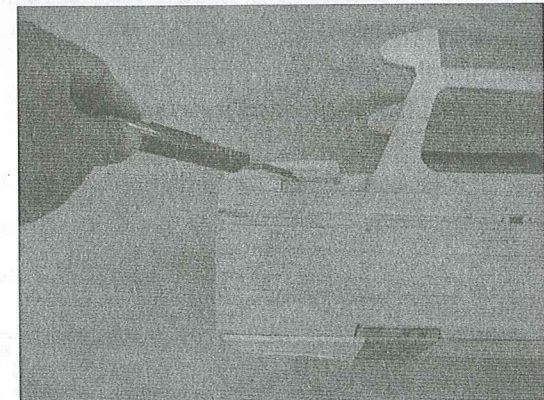

Use the hobby knife to open slots for hook and loop straps on the nose of fuselage.

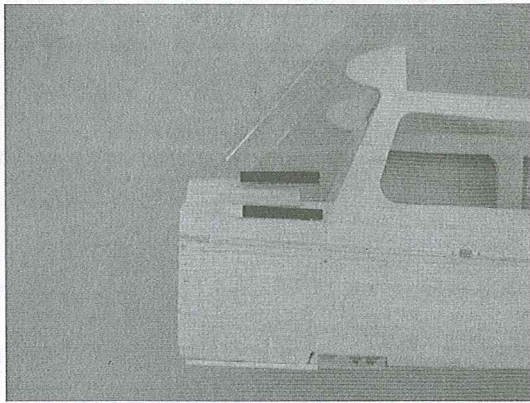

Glue one small piece of hook and loop strap on the slots opened in previous step. Place the canopy in place. When satisfy the location, use pencil to mark the position of the hook and loop strap on both sides of canopy. Glue the same size of hook and loop straps on the marked location inside the canopy.

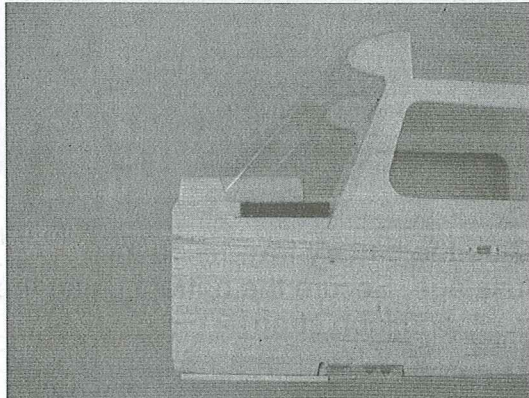

Secure the canopy in place by pressing the look and loop straps together.

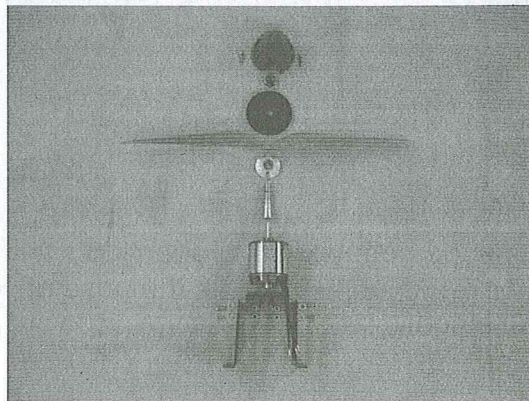

Assemble the power unit as indicated in the picture.

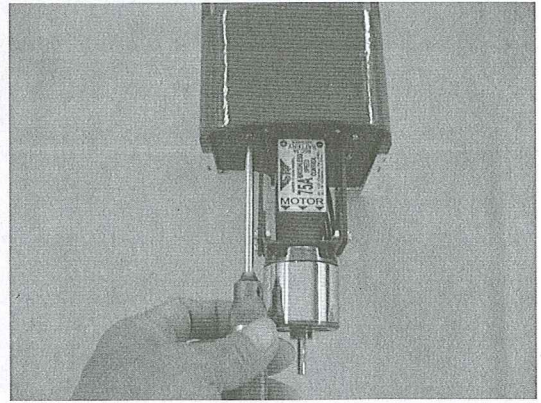

Secure the power unit on the motor mount (on the F1 1.5mm hole) with 3 x 10mm tapping screws x 4 pieces..

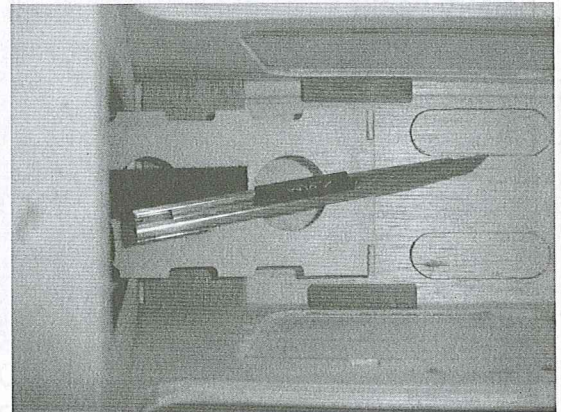

Use the hobby knife to cut out the in-take and cooling hole.

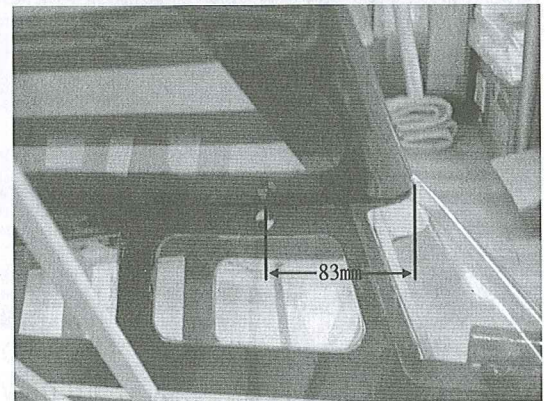

The recommended Center of Gravity location is 83mm back from the leading edge against the fuselage.

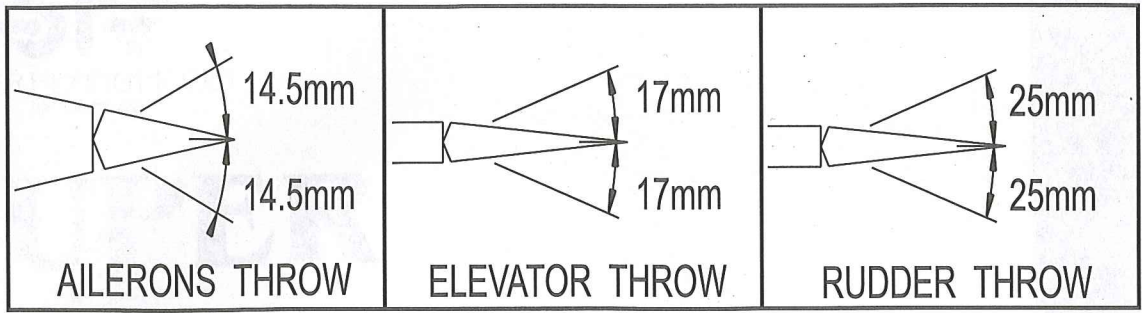

**FOR THE GP VERSION**

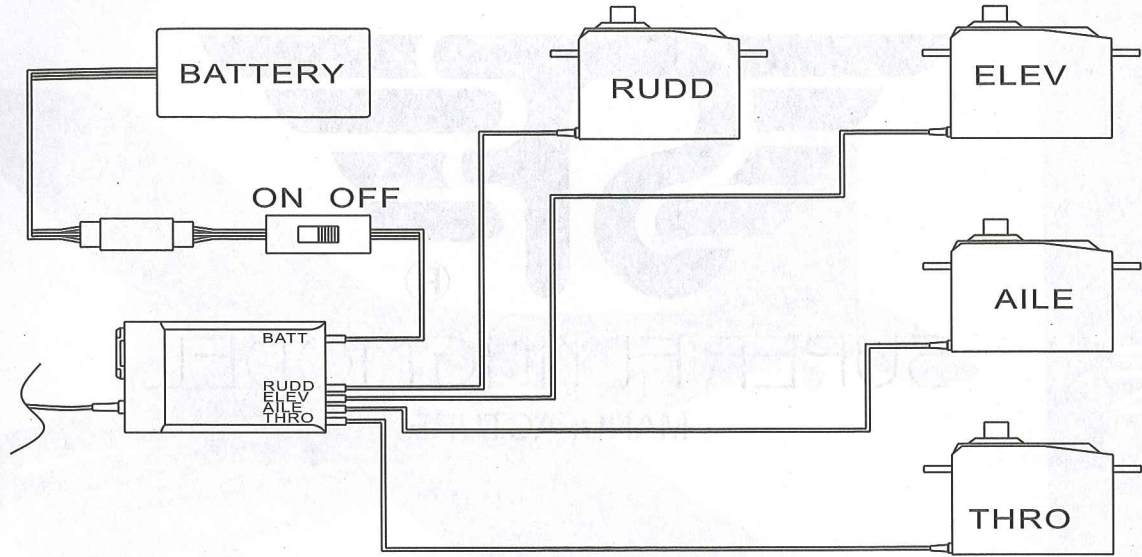

**FOR THE EP VERSION**

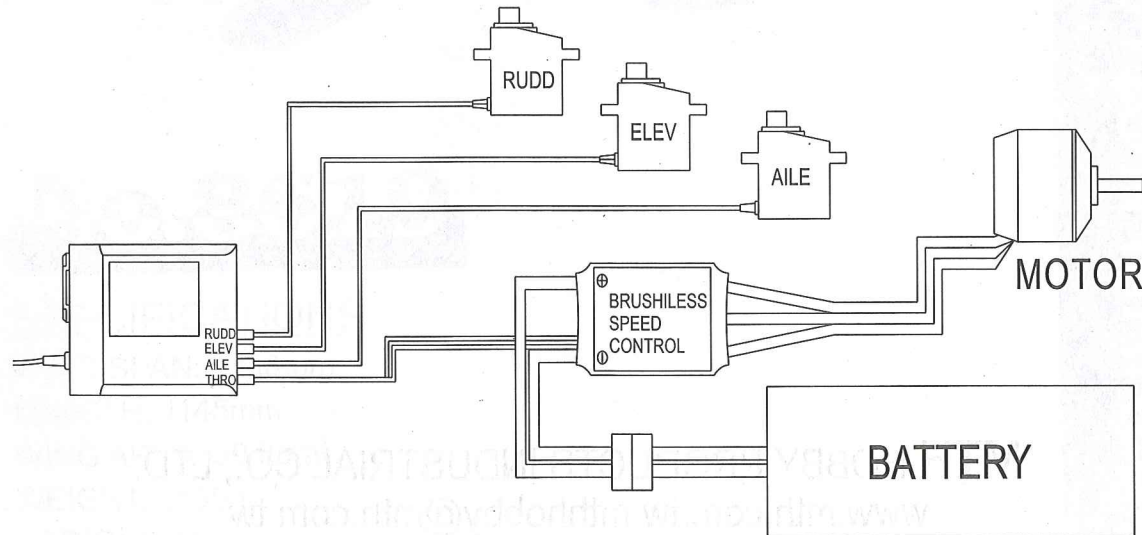



SUPER FLYING MODEL  
MANUFACTURE

MTH HOBBY PRODUCTS INDUSTRIAL CO., LTD.  
[www.mth.com.tw](http://www.mth.com.tw) [mthhobby@mth.com.tw](mailto:mthhobby@mth.com.tw)  
© MTH HOBBY 2009