

950mm 2.4GHz RTR R/C High Performance Racing Sailboat



dragonflite 95

For more information about the boat
and the DragonFlite 95 racing class, visit:

www.dfracing.world

Specification

- Length: 950mm
- Beam: 125mm
- Rig height: 1050mm
- Overall height: 1470mm
- RTR total weight 2000g (Batteries not included)
- Sail area (Mainsail): 2314cm²
- Sail area (Jib): 1422cm²
- Sail area (Overall): 3736cm²
- Overall height: 1470mm
- Hull material: Moulded plastic with painted finish and logo sticker
- Requires: 4pcs AA battery for transmitter & 4pcs AA battery for receiver



INSTRUCTION MANUAL

**THIS MODEL IS NOT A TOY
THESE INSTRUCTIONS SHOULD BE READ BY A SUPERVISING ADULT**

DRAGONFLITE 95 2.4GHz RTR RACING SAILBOAT

MODEL No: 8811

IMPORTANT:

- This is not a toy. Assembly and operating of this boat requires adult supervision.
- Please take time to read these instructions carefully and completely before attempting to operate your model. This manual contains the instructions you need to safely build operate and maintain you R/C sailboat.

BOX CONTENTS

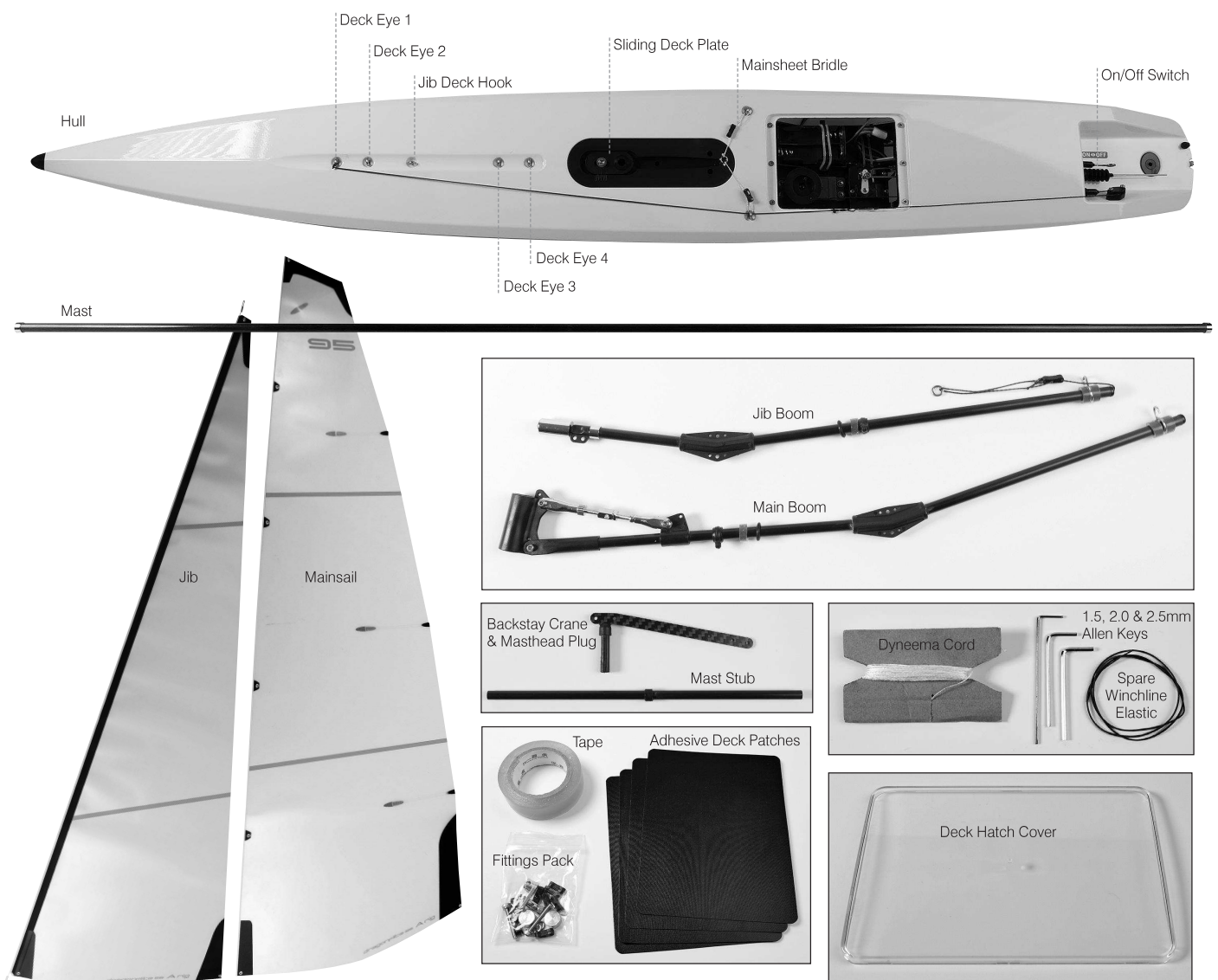

ITEMS REQUIRED FOR COMPLETION:

- Eight 'AA' Alkaline batteries. (Four for the transmitter, four for the Receiver Battery Box).
- Thin CA glue (cyanoacrylate/superglue).
- A pair of thin nosed pliers and a sharp craft knife or scalpel.

BASIC BOAT TERMINOLOGY

BOW	The front of the boat.
STERN	The back of the boat.
PORT	This is the left side of the boat when viewed from the Stern.
STARBOARD	This is the right side of the boat when viewed from the Stern.
HULL	The body of the boat.
DECK	The upper surface of the Hull.
KEEL	A weighted blade that protrudes from the bottom of the hull as a means of providing lateral stability.
RUDDER	The hinged vertical blade mounted at the Stern used as a steering device.



DISPLAY STAND ASSEMBLY

- 1 Identify all stand components from box.
- 2 Bolt the plastic moulded components together with the twelve nut & bolts supplied.
- 3 Construct the leg sections. *Note: All leg and stretcher tubes are of equal length.*
- 4 Fit the three stretcher tubes.
- 5 Fix the soft EVA foam supports to the top surface of the stand to protect the Hull from scratches.

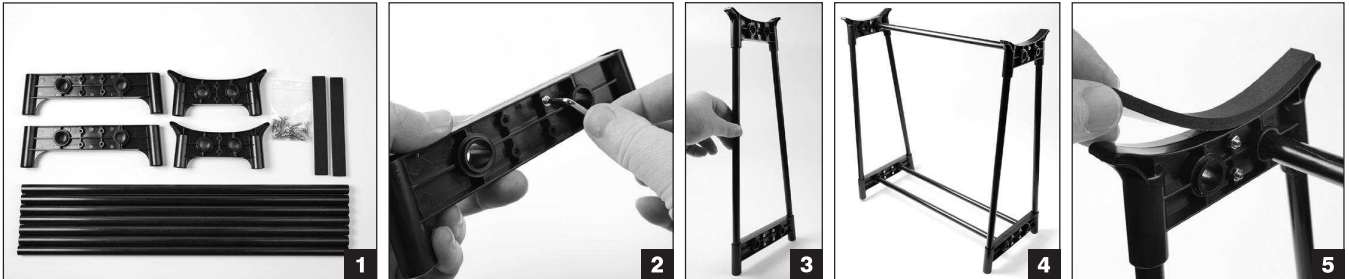

KEEL & KEEL BULB ASSEMBLY

- 1 Identify all Keel & Bulb components from box.
- 2 Insert plastic 'Shoes' into bulb slot.
- 3 *Tip: To make it easier to align the bolt holes in the Fixing Disk, mark the centres of the threaded holes on the side of the Fixing Disk.*
- 4 Insert the Fixing Disk into the pre-drilled hole in the Keel taking care to align the threaded holes and screw in the hex-head bolt to ensure everything is aligned correctly. It's a good idea at this point to stick the disk in place with a piece of thin tape to prevent it moving whilst fitting into the Keel Bulb. Then remove bolt.
- 5 Slide the Keel into the Bulb, between the Plastic Shoes and secure with the hex-head bolt.
- 6 Repeat step four for the top fixing.
- 7 Slide the top of the Keel into the Hull and secure with the remaining hex-head bolt.



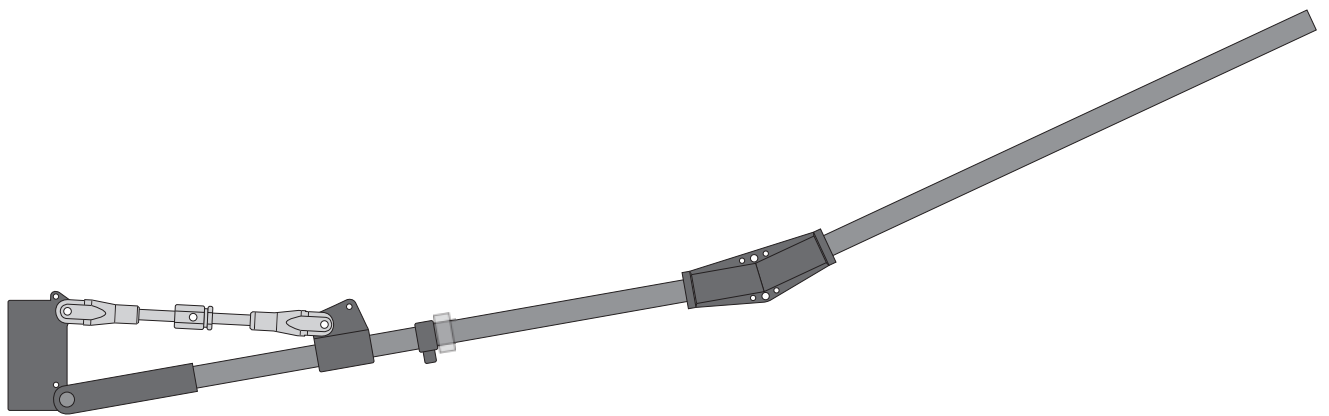

- 3** Fit the wire Mainsail Luff Rings to all six eyelets down the Mainsail Luff (front edge).
- 4** Slide the Mast Stub into the base of the Mast, taking care that the bevelled edge of the plastic collar is facing downwards.
- 5** Slide the whole Main Boom assembly on to the Mast Stub from below.
- 6** Starting with the lower Mainsail Luff Ring, slide all rings down the Mast.
- 7** Push the Backstay Crane and Masthead Plug assembly into the top of the Mast. Cut a 250mm length of Dyneema and tie the head of the Mainsail to the Backstay Crane as shown. Align the top of the sail with the top of the metal mast reinforcement ring. *Note: Tie this with only a single strand of Dyneema, this will allow the head of the sail to swivel easily when the boat is running with the wind and the booms are sheeted out at 80°.*
- 8** Cut a 300mm length of Dyneema and tie the Cunningham (downhaul) as shown. Start by tying one end to the eye in the top of the Gooseneck fitting, take the cord through the eye at the bottom of the Mainsail Luff, back through the Gooseneck eye, lead it back along the Boom, through a Bowsie and the eye in the Compression Strut fitting and finish off back through the Bowsie.
- 9** Hook the eye in the Mainsail Clew (bottom rear corner) onto the Mainsail Clew Hook.
- 10** Using a pair of thin nosed pliers close up slightly the open end of the Hook to prevent the sail eye slipping off the hook when sailing. *Note: This can be opened out again with a flat bladed screwdriver if you need to remove the sail.*
- 11** Cut a 900mm length of Dyneema for the Backstay. Tie one end to the end hole in the Backstay Crane (see photo 7). Tie one of the supplied 6mm metal rings to the bottom end (see photo 12). Slide the Mast and rigged Mainsail into the Mast Socket in the deck.
- 12** To make the adjustable lower section of the Backstay, cut a 500mm length of Dyneema, tie a loop in one end, thread the other end through the first two holes in a Bowsie, then through the metal ring at the bottom of the Backstay and finish off back at the Bowsie. Hook the loop into the metal hook in the Transom (back edge of the hull), apply a light tension to the Backstay, position the Bowsie roughly midway along the lower cord and tie it off
- 13** Adjust the Compression Strut so that the Leech (back edge) of the Mainsail is under light tension and then back it off a turn to allow the Leech to twist slightly. Adjust the Cunnigham to apply very light tension down the Luff of the sail.
- 14** Set the length of the Backstay as shown in the diagram opposite.
- 15** Adjust position of Silicon Rings SR5 & SR6 and the Mainsail Clew Hook so the Mainsail Foot can form a curve with a distance of approximately 25mm between the centre of the boom tube and the sail foot at its midpoint.

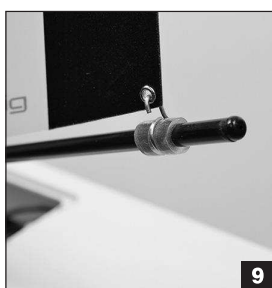
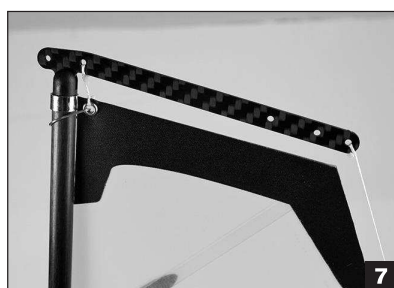
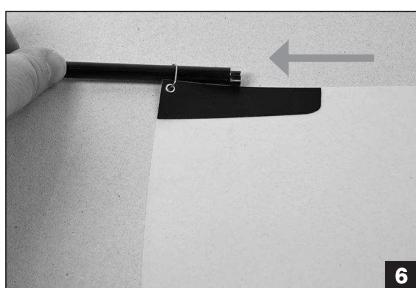
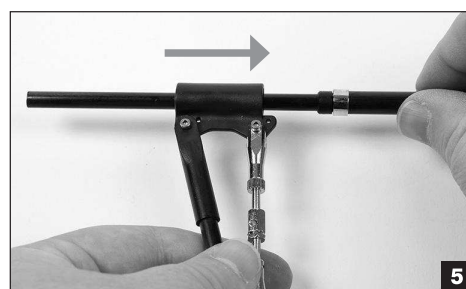
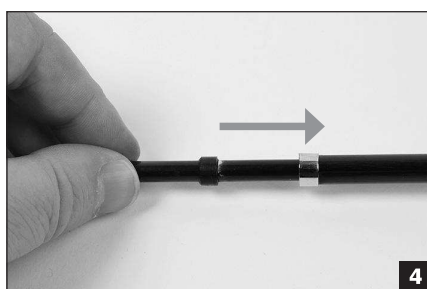
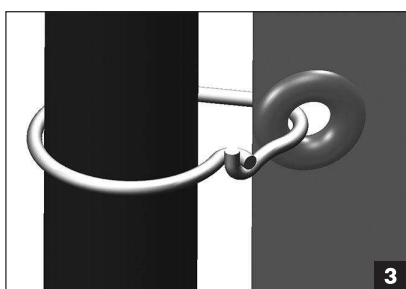

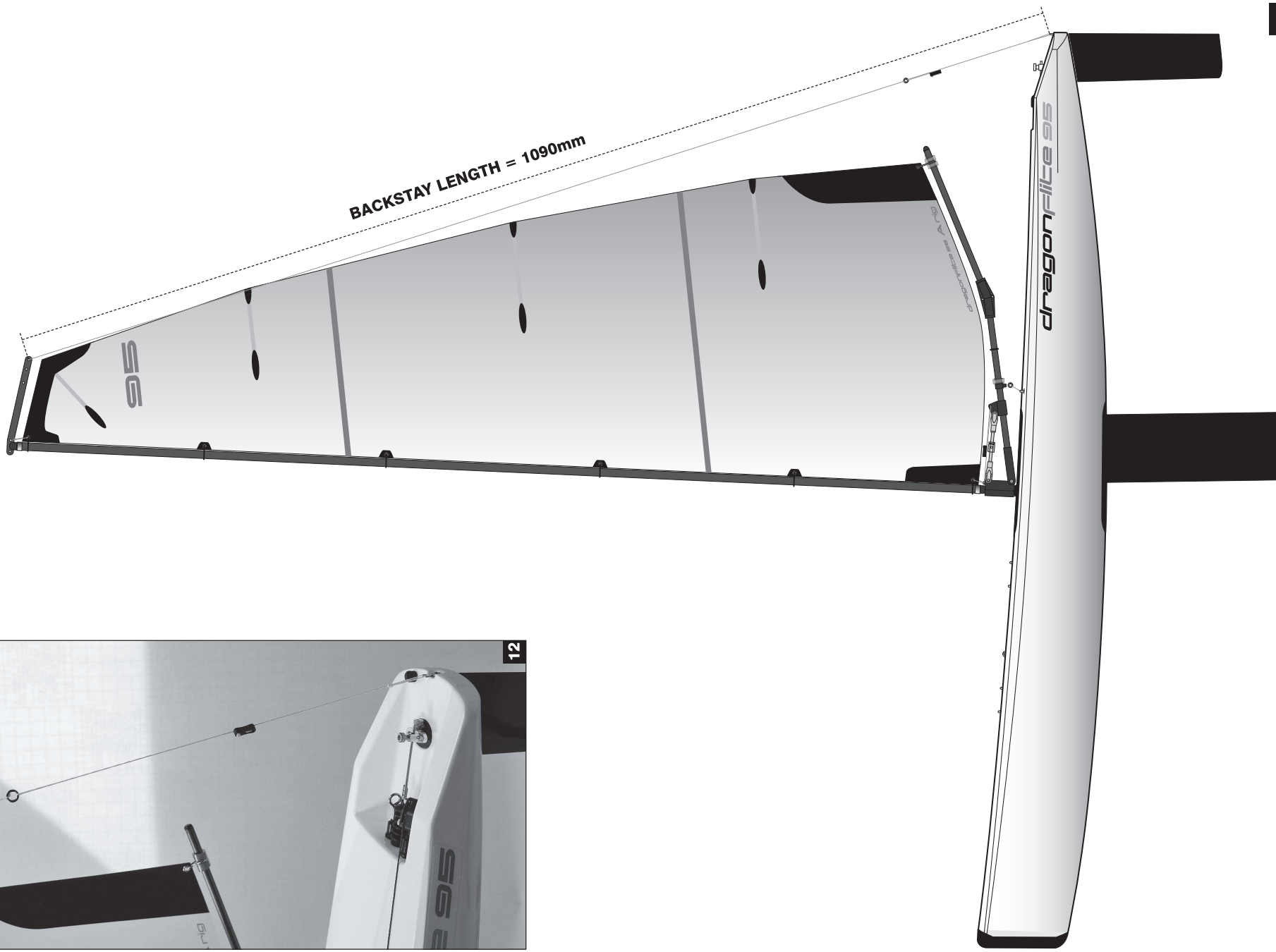
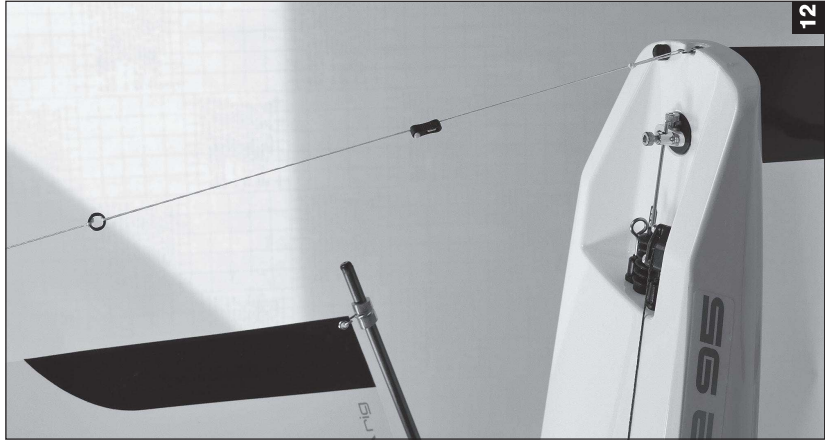

JIB BOOM SETUP

- 1 Set the Jib Sheet Guide and Silicon Ring SR1 to the position shown above.
- 2 Cut a 450mm length of Dyneema to form the Jib Boom hook-down. Tie a loop of approximately 25mm length in one end and secure the knot with a drop of CA glue. Make a mark at 65mm from the end of the knot.
- 3 Thread the Hook-Down line as shown in photo 3. Start by threading the loose end of the cord up through the lower, central eye in the Boom Joiner, then through the top, central eye, back down through the lower eye again, lead it forwards along the underside of the Boom, through the first two holes in a Bowsie, through the rear of the two eyes in the Front End Fitting and take it back through the final hole in the Bowsie. Do not tie off the final knot until completing the following stage. Adjust the cord so that the mark you made is positioned at the lower edge of the Boom Joiner and set the Bowsie midway between the front end fitting and the boom joiner and tie off the final knot to secure the Bowsie.

Note: When the full rig is completed the easiest way to install the rig is as follows:

- *Insert the Mast into the Mast Socket in the Hull.*
- *Slacken off the Bowsie adjuster on the Jib Hook-Down, thread the loop through the front Deck Eye (Deck Eye 1), lead it back through Deck Eye 2 and hook the loop over the Jib Deck Hook. Tighten the Hook-Down Bowsie to get the Jib Boom as low to the deck as possible.*
- *Hook the Backstay on to the Backstay Hook in the Transom and tension the Backstay Bowsie.*
- *When de-rigging do the reverse of this process. Using this rigging procedure there is no need to adjust the Forestay tension so the correct rig trim is quick and easy to achieve.*

10 Slacken off the Bowsie adjuster on the Jib Hook-Down, thread the loop through the front Deck Eye (Deck Eye 1), lead it back through Deck Eye 2 and hook the loop over the Jib Deck Hook. Tighten the hook-down Bowsie to get the Jib Boom as low to the deck as possible.

11 Cut a 200mm length of Dyneema to form the top of the Forestay. Tie one end to the wire loop in the top of the Forestay wire, thread up through the first two holes of a Bowsie, through the metal ring and back through the final eye of the Bowsie. Pull some tension into the Forestay and tie off the final knot in the Bowsie with the Bowsie positioned about 10mm from the metal ring. When secured, pull down to apply more tension into the Forestay until the Luff of the Jib starts to wrinkle. Cut a 150mm length of Dyneema and tie the top eyelet in the jib to the wire loop in the Forestay with enough tension to remove the wrinkles in the sail's Luff.

Note: Before tying the sail head ensure the gap is still 5mm between the Jib Foot and the top of the Front End Fitting. After this is complete, the Bowsie on the Jib Cunningham can then be used to fine tune the tension in the Jib Luff.

12 Now set the mast rake (angle) by adjusting the Forestay Bowsie to obtain the dimensions shown in the rig diagram on the next page. To achieve these measurements you will have put a lot of tension into the Forestay and Backstay. This tension is needed to keep the rig stable which will give you consistent handling characteristics in different wind conditions.

13 Cut a 1000mm length of Dyneema to form the Topping Lift. Start by tying one end to the metal ring in the Forestay (See photo 11). Then tie the bottom end of the cord to the ring attached to the Bowsie adjuster at the back end of the Jib Boom. Adjust the Bowsie to allow a little slack in the Jib Leech (back edge).

14 Adjust position of Silicon Rings SR2/3 and the Jib Clew Hook so the Jib Foot can form a curve with a distance of approximately 25mm between the centre of the boom tube and the sail foot at its midpoint.

At this stage you have completed the rigging, the next sections will cover the fitting of 'Sheets' (control lines) to the Booms and setting the rig up for best performance and boat trim.

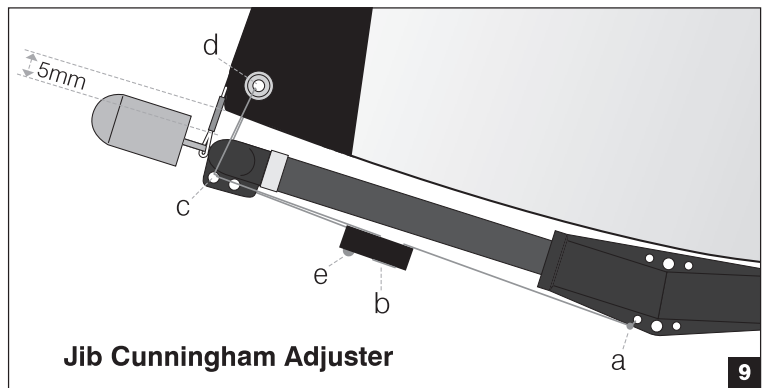
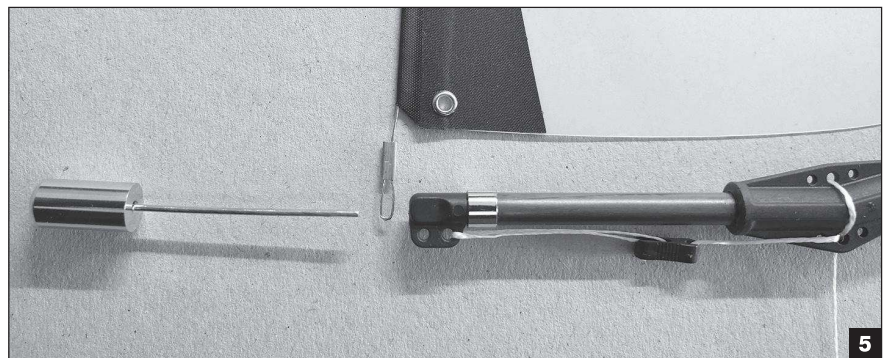

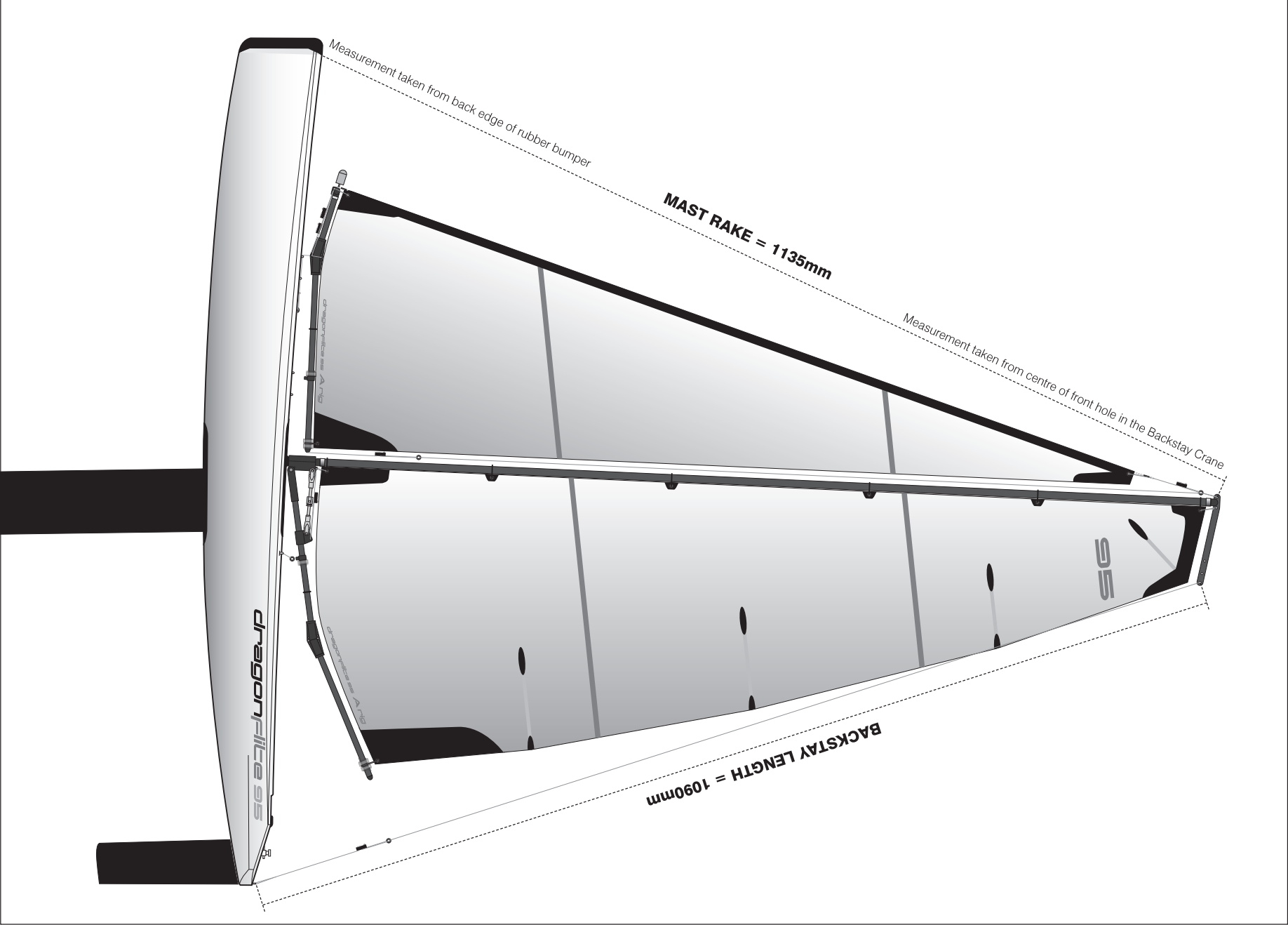

POWERING UP THE BOAT

If you've bought the 'Ready To Race' version of the boat you will have the Joysway Transmitter and Receiver. The transmitter (Tx) and Receiver (Rx) will already be 'bound' and full operating instructions for this radio set are supplied.

If you are using your own Tx/Rx equipment we will assume you will be familiar with all it's functions and the following guide covers the setup of the boat only.

- 1 Connect up the Servo, Winch and Battery Switch cables up to the Receiver as follows:
 - Rudder Servo plugs into Channel 1 socket.
 - Sail Winch plugs into Channel 3 socket
 - On/Off Switch plugs into Battery socket (check your own Tx manual for this connection)
- 2 Install four, AA batteries into the Battery Holder and secure into the tray with the silicone band provided. Plug the batteries into the spare lead from the On/Off Switch.
- 3 With both Tx control sticks in their central positions switch on the boats On/Off Switch by pushing the wire switch arm forwards in the cockpit as indicated by the sticker.

Note: At this stage check that the control sticks on your Transmitter operate in the correct direction. Looking forward from the back of the boat when the rudder control stick is moved to the right, the Rudder should turn to the right. When the Sail Winch control stick is moved down, the clip on the Winch Line should move to its furthest back position (sheeted in). If either of these actions is reversed, consult your manual for instructions on how to reverse the stick actions.

- 4 With the rudder control stick and fine adjuster on the Transmitter set in their central position, check to see if the Rudder Blade is centred in line with the Keel when viewed directly from behind. If not, use the Allen Key to adjust the top grub screw on the Rudder Arm.
- 5 Now set the sheeted in and out positions for the Winch Line. Diagram 5 shows the ideal positions for these sheeting points. Set the sheeted in (close hauled) position first. Pull the sailwinch control stick on the Tx fully down with it's fine adjuster set in its central position, if the end of the winch line clip is in a different position to that shown, unscrew the drum on top of the Sail Winch and rotate until the clip position is correct and then re-tighten the drum. The ideal amount of winch line travel between fully sheeted in and out is 128mm. This travel will give you the ideal sheeted out position for running with the wind with the booms out.

Note: It's a good idea to mark these two positions on the deck as a permanent reference points for consistent sheeting adjustment. The sheeting points shown are not too critical but what is important is the amount of travel between the two points of 128mm. On better quality Transmitters you will be able to adjust the sheeting end points individually through its software menus.

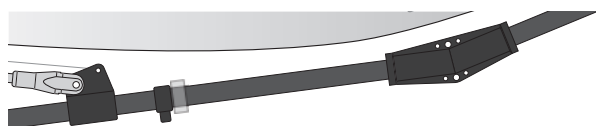
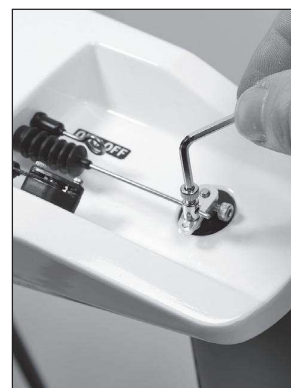
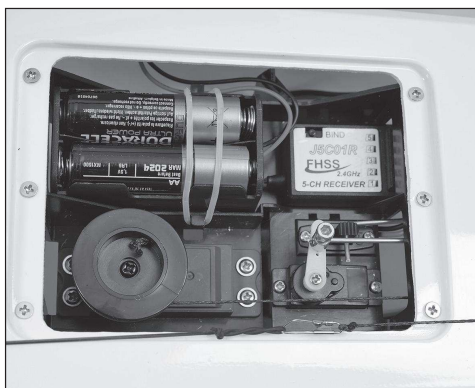

5

SHEETING SETUP

- 1 Adjust the bowsies on the mainsheet bridle to position the metal sheeting ring centrally in the position shown in photo 1. It is essential for consistent sheeting angle on both port and starboard tacks (When looking forward from the back of the boat if the wind is coming over the right hand side if the hull you are sailing on starboard tack).
- 2 For initial sheet setup of both the Jib and Mainsheet, pull the winchline in to its close-hauled (sheeted fully in) position and don't move it until both sheets are fully installed.
- 3 Cut a 600mm length of Dyneema for the Mainsheet. Tie a loop in one end and clip it in to the Winch Line Clip(a), run it forward and through the metal ring on the Mainsheet Bridle(b), up through the Mainsheet Guide(c) on the Mainboom, back along the boom through the 'O' Ring(d), through the first two holes in a Bowsie(e), back through the first hole in the Boom Joiner(f) and forward through the final hole in the Bowsie(g). With the Mainboom positioned on the hull's centreline, position the bowsie approximately midway between (c) & (f) and tie off the final knot to secure the Bowsie.
- 4 Cut an 850mm length of Dyneema to form the Jibsheet. Tie a loop in one end and clip it in to the Winch Line Clip(a), run it forward underneath the Mainsheet Bridle(b), forward through Deck Eye 3(c), up through Jibsheet Guide(d), run it forwards underneath the Jib Boom, through the 'O' Ring(e), through the first two holes of a Bowsie(f), forward and through the rear hole in the Boom Joiner(g) and back through the final hole in the Bowsie(h). Hold the back end of the Jib Boom over the edge of the Hull (Gunwhale), position the Bowsie approximately midway between (d) & (g) and tie the final knot to secure the Bowsie.
- 5 With the Winchline still in its fully sheeted in position adjust the Bowsies on the Jibsheet and Mainsheet so the boom rear ends are in the positions shown in Diagram 5 (opposite page). If you have the 128mm of winchline travel set up when you sheet out the booms should be approximately in positions shown.

You should now almost have a fully set up rig. The only trimming left to do is to adjust the amount of twist in the leeches (back edges) of both sails. The twist in the Mainsail can be controlled by adjusting the metal Compression Strut, the Jib twist is controlled by adjusting the Bowsie at the bottom of the Topping Lift. It's hard to define the amount of twist in figures, but the photos on the opposite page show a well adjusted rig with correct twist and boom sheeting angles. If you can match this rig setting you will have a well balanced and easy to sail boat.

- 6 Before you put the boat on the water fit the clear Deck Hatch and seal with one of the supplied adhesive Deck Patches. An easy method to do this is to lay the adhesive Deck Patches face down on a smooth, hard surface, peel back the backing paper and place the clear Deck Hatch upside down in the centre of the patch. Turn over and locate in the Deck Hatch Opening in the deck, make sure the adhesive patch is pressed down to form a waterproof seal around the hatch. You are now ready to sail!

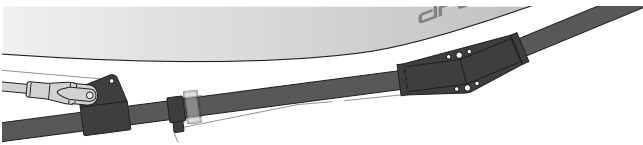

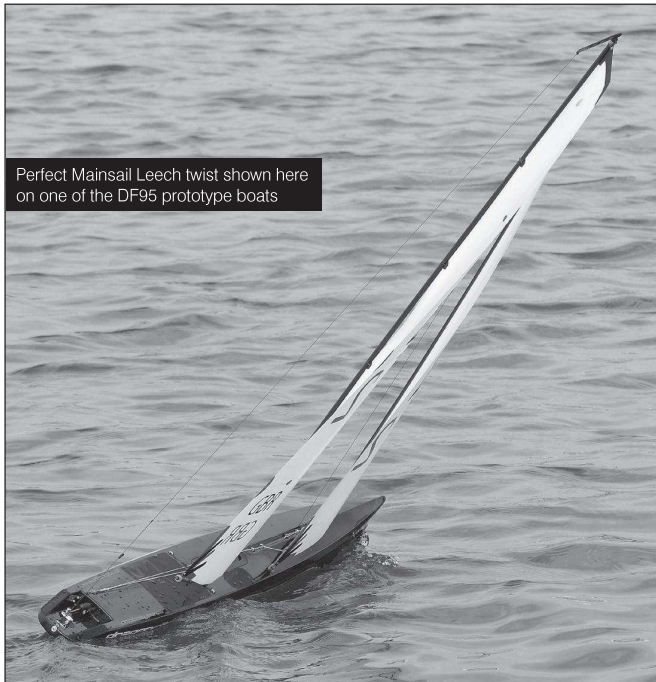
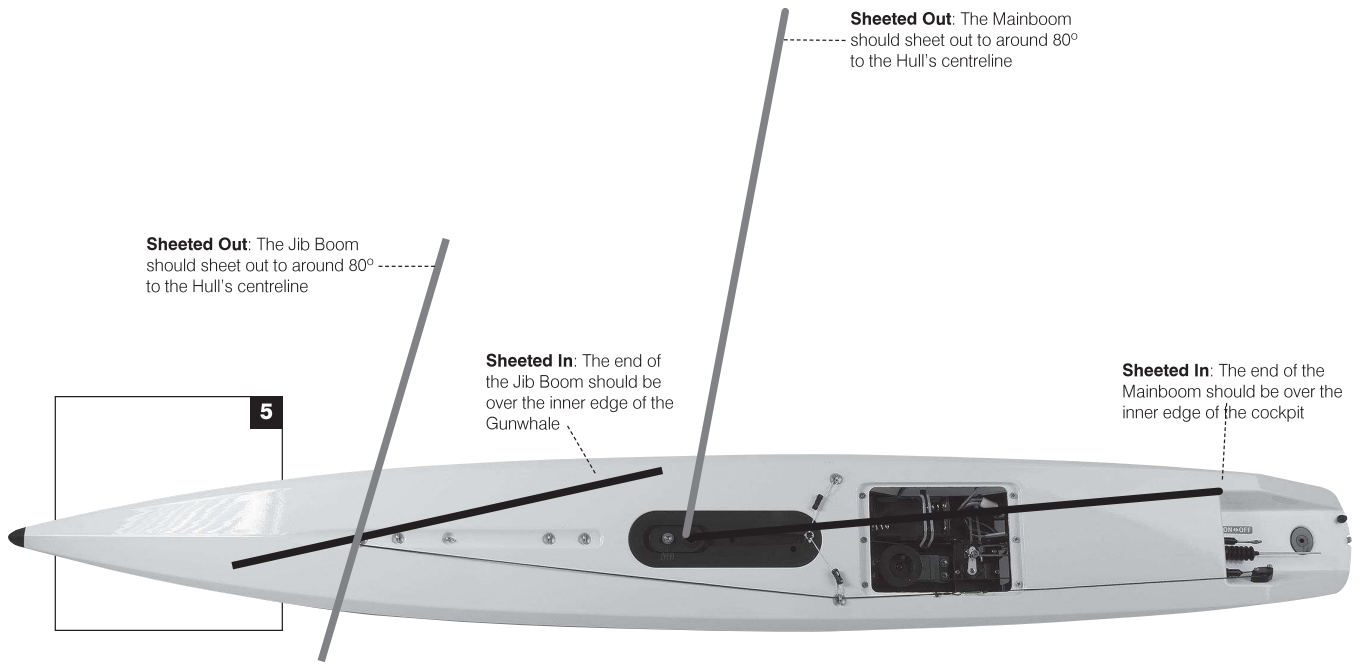

BASIC SAILING TERMINOLOGY

Unlike propeller driven boats that you basically point and accelerate, sailboats present an interesting challenge. Sailing requires constant reaction to water movements, any wind gusts and any wind direction changes. These reactions then require adjustment of the rudder and sails in order to find the best possible course. There is no substitute for actual 'on-the-water' experience and after your first couple of outings you may want to read through this manual again in order to help you to gain a better understanding of the 'art' of sailing. While learning to sail, it is a good idea to pick up on as much sailing terminology as possible. This will make it easier to grasp some aspects of the sport.

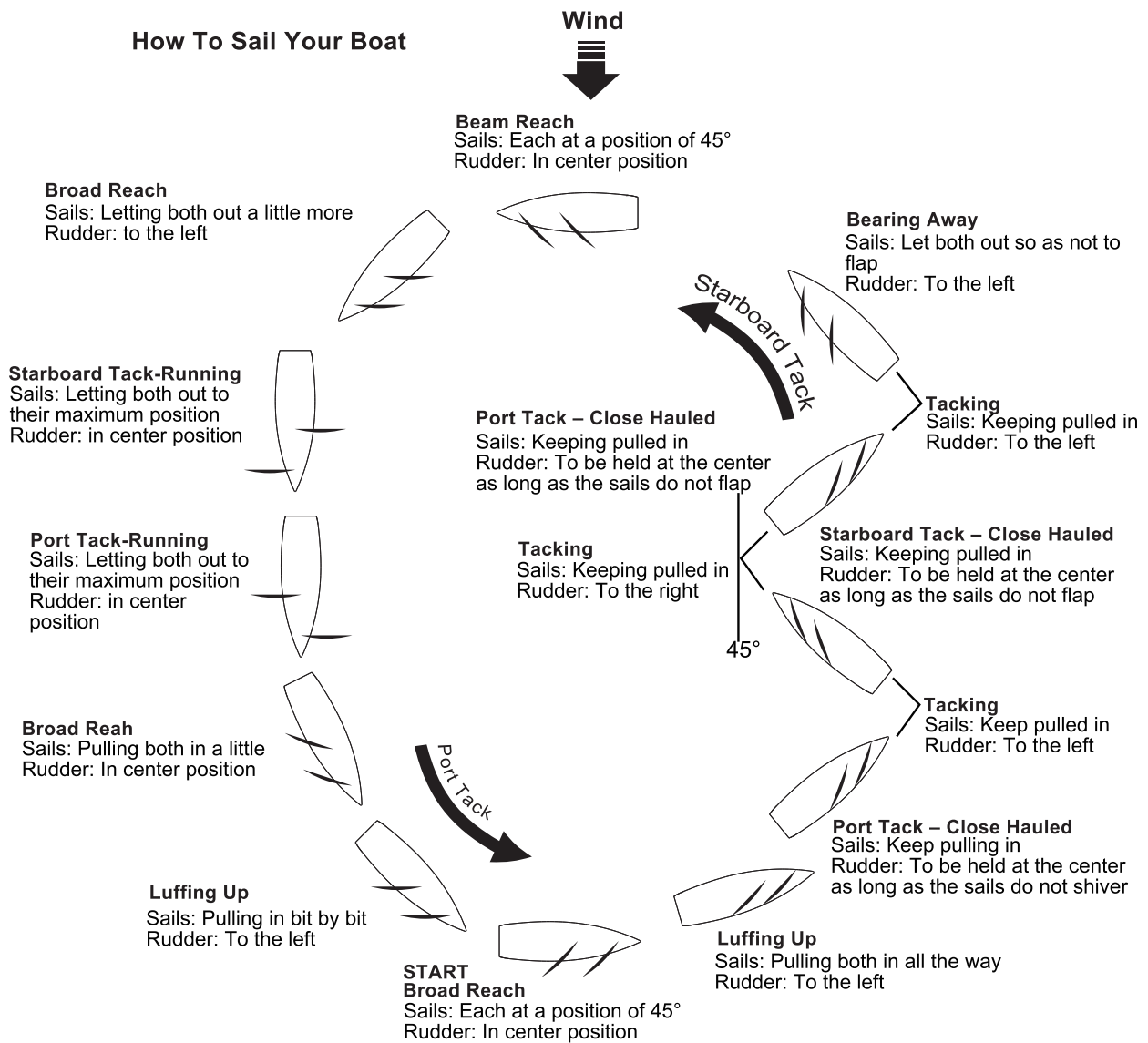

IMPORTANT NOTICE

- Only sail your DragonFlite 95 in still bodies of water. Never sail it in running water such as rivers or tidal waters. If you loose control of the boat you could loose it forever!
- Never attempt to swim after a stalled or stuck boat. Wait patiently for the boat to drift ashore or be rescued.

MAINTENANCE

If properly rigged and maintained the DragonFlite 95 will be a very 'dry' boat. This is a very good thing as water and electrics are not the best of friends!

There are some essential steps you need to take to keep your boat working as it should, these are:

- The bearings in the top and bottom of the Gooseneck should be washed in clean, fresh water after every outing if you sail in saltwater.
- Regularly lubricate the bearings with bearing lube or any similar product.
- Wash the whole boat and rig with clean, fresh water after every outing if you sail in saltwater.
- Open the Hatch Cover and allow the inside of the boat to completely dry out after sailing. Do not store the boat with either water or condensation inside the hull, it will lead to electrical failure through corrosion or 'black wire' failure.
- Dyneema cord can shrink in certain conditions. So check often that all your rig settings remain correct.
- Handle and store the Sails with great care. Don't leave them flapping whilst your boat sits on its stand, lay the boat down on a soft surface with the rig downwind of the hull. When not in use keep the rigs in a rigid rig box or fairly stiff rig bag. Look after your rigs - they are your boat's engine!

SPARE PARTS LIST

Item No	Item Name
881101	DF95 Complete "A" Rig Assembly with 10m cord (No Sails)
881102	DF95 Complete "B" Rig Assembly with 10m cord (No Sails)
881103	DF95 Complete "C" Rig Assembly with 10m cord (No Sails)
881104	DF95 Complete "D" Rig Assembly with 10m cord (No Sails)
881105	DF95 "A" 50 micron mylar film sails
881106	DF95 "B" 75 micron mylar film sails
881107	DF95 "C" 75 micron mylar film sails
881108	DF95 "D" 75 micron mylar film sails
881109	DF95 Mast Pack A
881110	DF95 Mast Pack B
881111	DF95 Mast Pack C
881112	DF95 Mast Pack D
881113	DF95 Mast Head Pack A
881114	DF95 Mast Head Pack B
881115	DF95 Mast Head Pack (C & D identical)
881116	DF95 Main Boom Pack A
881117	DF95 Main boom Pack B
881118	DF95 Main Boom Pack C
881119	DF95 Jib Boom Pack A
881120	DF95 Jib Boom Pack D
881121	DF95 Jib Boom Pack C
881122	DF95 Mainsail luff Ring (PK10)
881123	DF95 Transparent Hatch(PK2)
881124	DF95 Water seal tape(PK2)
881125	DF95 Deck cloth patch(PK4)
881126	DF95 Front bumper(PK2)
881127	DF95 Sheeting pulley block(PK2)
881128	DF95 Fin box and mast fitting
881129	DF95 Rudder

SPARE PARTS LIST

Item No	Item Name
881130	DF95 Carbon keel with bolts
881131	DF95 Bolts(PK4)for keel
881132	DF95 Ballast with plastic Shoe fitting
881133	DF95 Plastic shoe
881134	DF95 Pushrod
881135	DF95 Switch connector+Switch rod
881136	DF95 Painted Hull(without decals)+front bumper
881137	DF95 Jib Boom Front End Fitting(PK4)
881138	DF95 Boom Joiner (PK4)
881139	DF95 Main Boom Pack D
881140	DF95 Hull decals set
881141	A sails reinforcement adhesive patches+battens
881142	B sails reinforcement adhesive patches+battens
881143	C sails reinforcement adhesive patches+battens
881144	D sails reinforcement adhesive patches+battens
881145	Stainless steel wire for A jib sail (PK2)
881146	Stainless steel wire for B jib sail (PK2)
881147	Stainless steel wire for C jib sail (PK2)
881148	Stainless steel wire for D jib sail (PK2)
881149	Eyelet (PK20) for reinforcement adhesive patch
881150	Jib luff tape (2cm x 100cm) (PK10)
881151	Double-sided seam tape (50m) for Jib luff tape
881152	280mm short carbon keel with bolts
881153	DF95 Mast fitting tube
881154	DF95 Mainsheet Bridle Keelboat Fitting (Pk 2)
881155	J4C05 transmitter(MODE2)with J5C01R Receiver
881157	DF95 Bearing (PK4)
881158	DF95 Jib Boom Pack B
881159	DF95 Painted Black Hull(without decals)+front bumper
881160	DF95 Painted Blue Hull(without decals)+front bumper
881161	DF95 Painted Purple Hull(without decals)+front bumper
881162	DF95 Painted Orange Hull(without decals)+front bumper
881163	DF95 Painted Yellow Hull(without decals)+front bumper
881203	Metal sail clew hook(PK10)
881204	0.6mm Dyneema cord(10m length)
881209	Jib boom counterweight with shaft(PK4)
881210	Bowsie(PK10)
881211	10cm Silicon tube+"O"ring(PK4)
881212	Sheeting elastic(2m)
881217	Aluminum alloy rudder arm set
881218	Plastic servo tray with screws
881225	Jib hook(PK10)
881226	Sail winch servo
881227	Waterproof Bellows(PK4)
881228	Cord attachment clip (PK10)
881229	Mainsheet metal ring (PK4)
881504	New digital metal gear Rudder Servo
881505	J4C05 Transmitter
881506	J5C01R Receiver for J4C05 Transmitter
880532	Deck eyes (pk10)
880536	Rubber bung (PK4)
880552	Battery box for receiver
880623	Winch line rubber cap(PK5)
990202	Plastic boat stand



FCC REQUIREMENT



This device complies with Part 15 of the FCC Rules. Operation is subject to the following two conditions: (1) This device may not cause harmful interference, and (2) This device must accept any interference received, including interference that may cause undesired operation.

CAUTION: Changes or modifications to this product not expressly approved by the party responsible for compliance may void the user's authority to operate the equipment.

For more information about the boat and the DragonFlite 95 Racing Class please visit

www.dfracing.world