

Inhalt
Contents
Contenu

Inhoud
Contenido
Conteúdo

Contenuto
Содержание
目录

Einzelteilübersicht / Spare parts list / Liste des pièces détachées / Onderdelenoverzicht / Lista da piezas / Resumo de peça individual /
Singoli componenti / Перечень деталей / 零件概览 2

Montagetipps / Tips for assembly / Tuyaux pour le montage / Montagetips / Consejos para el montaje / "Dicas" para montagem /
Consigli per il montaggio / Советы по сборке / 装配建议 3

Wind-Antrieb / Wind drive / Traction éolienne /
Aangedreven door de wind / Impulsión por viento /
Acionamento eólico / Azionamento a vento /
Ветровой привод / 风驱动 5

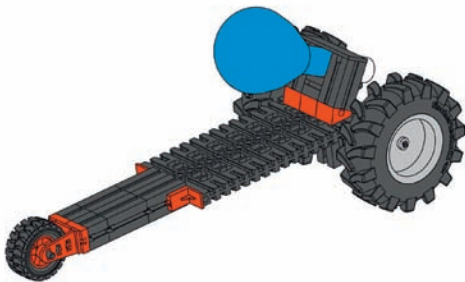
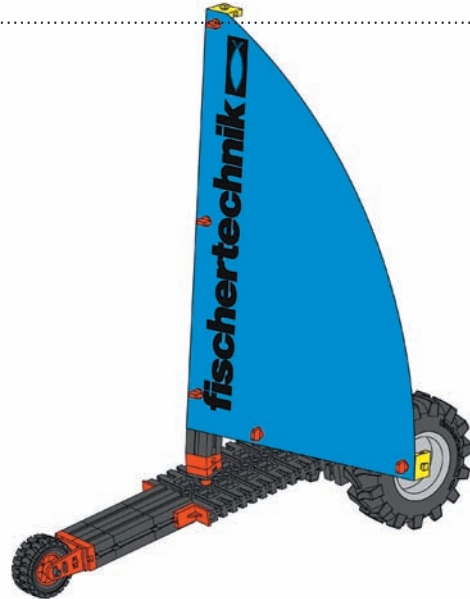

Luftballon-Antrieb / Balloon drive / Traction aérienne à
l'aide d'un ballon / Aangedreven door een luchtballon /
Impulsión por globo / Acionamento de balão de ar /
Azionamento con palloncino / Привод от
воздушного шарика / 气球驱动 10

Biegestab-Antrieb / Bending rod drive / Traction par flexion /
Aangedreven door een gebogen staaf / Impulsión por barra de
flexión / Acionamento de arco / Azionamento a barra pieghevole /
Привод от изогнутого стержня / 弯曲杆驱动 13

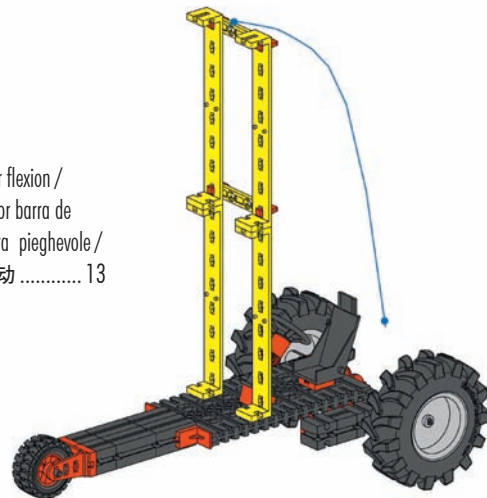

Gummimotor / Rubber band motor / Moteur caoutchouc /
Gummimotor / Motor de goma / Motor de borracha
elástica / Motore con elastico / Мотор с резинкой /
橡皮筋马达 16

Trike mit Rückzugsmotor / Trike with pullback motor / Trike à
moteur à ressort / Trike met terugtrekmotor / Triciclo moto-
rizado con motor de retroceso / Triciclo com motor de corda /
Trike con motore a carica / Трёхколёсный автомобиль
с возвратным двигателем / 配回力马达的三轮摩
托车 19

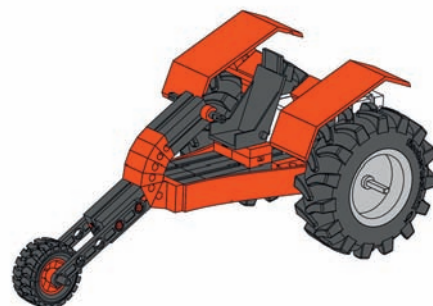

Inhalt
Contents
Contenu

Inhoud
Contenido
Conteúdo

Contenuto
Содержание
目录

Buggy mit Rückzugsmotor / Buggy with pullback motor /
Buggy à moteur à ressort / Buggy met terugtrekmotor /
Buggy con motor de retroceso / Buggy com motor de corda
/ Buggy con motore a carica / Багги с возвратным
двигателем / 配回力马达的沙漠赛车 21



Fahrzeug mit Lenkung / Vehicle with steering /
Véhicule à direction / Voertuig met besturing /
Vehículo con dirección / Veículo com direção /
Veicolo con sterzo / Автомобиль с рулевым
управлением / 配转向系统的车辆 24

Offroader mit Lenkung und Federung / Offroad vehicle with
steering and spring suspension / Véhicule tout-terrain
à direction et suspension / Off-roader met besturing en
vering / Todoterreno con dirección y suspensión / Veículo
offroad com direção e suspensão de molas / Fuoristrada con
sterzo e sospensioni / Внедорожник с подвеской и
рулевым управлением / 配转向系统和弹簧减
震系统的越野车 28

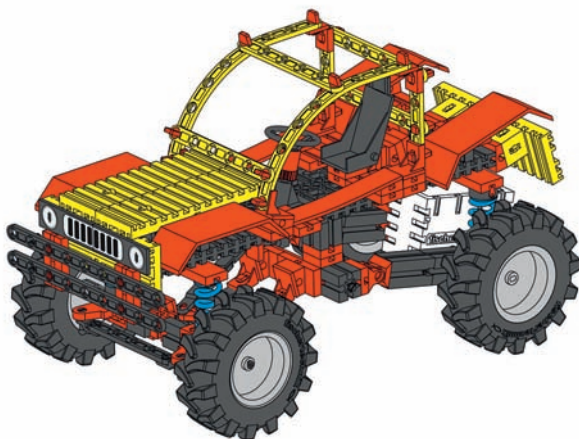

Offroader mit Rückzugsmotor / Offroad vehicle with pullback
motor / Véhicule tout-terrain à moteur à ressort / Off-roader
met terugtrekmotor / Todoterreno con motor de retroceso
/ Veículo offroad com motor de corda / Fuoristrada con
motore a carica / Внедорожник с возвратным
двигателем / 配回力马达的越野车 34



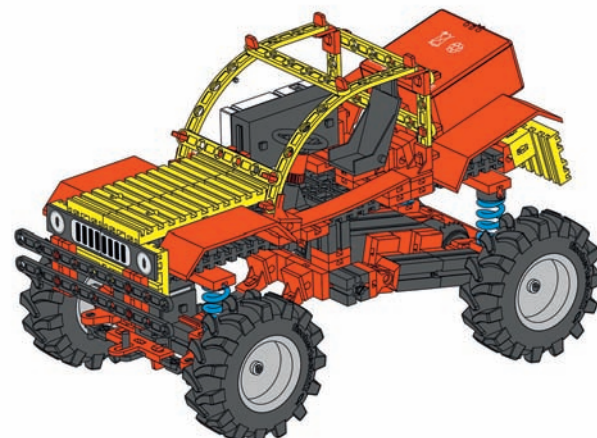











































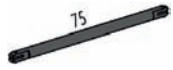

Ferngesteuerter Offroader / Remote controlled offroad vehicle
/ Véhicule tout-terrain téléguidé / Afstandsgestuurde
off-roader / Todoterreno con control remoto / Veículo offroad
com controle remoto / Fuoristrada telecomandabile /
Внедорожник с дистанционным управлением
/ 遥控越野车 38







Einzelteilübersicht
Spare parts list
Liste des pièces détachées

Onderdelenoverzicht
Lista da piezas
Resumo de peça individual

Singoli componenti
Перечень деталей
零件概览



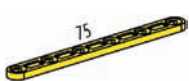

	31 010 1 x		31 892 4 x		32 882 2 x		36 324 2 x
	31 011 3 x		31 894 1 x		35 033 4 x		36 334 2 x
	31 016 1 x		31 896 4 x		35 049 19 x		36 912 1 x
	31 020 1 x		31 915 1 x		35 054 4 x		36 913 2 x
	31 060 7 x		31 916 1 x		35 060 2 x		36 952 2 x
	31 061 2 X		31 981 12 x		35 064 4 x		37 237 16 x
	31 426 2 X		31 982 9 x		35 065 1 x		37 238 8 x
	31 436 2 X		31 983 2 x		35 066 1 x		37 468 5 x
	31 597 2 X		31 984 1 x		35 067 1 x		37 636 1 x
	31 637 1 X		32 064 4 x		35 068 2 x		37 679 4 x
	31 670 2 x		32 071 4 x		35 073 2 x		38 240 2 x
	31 674 8 x		32 851 1 x		35 087 1 x		38 241 4 x
	31 690 1 x		32 852 1 x		35 129 2 x		38 244 3 x
	31 843 2 x		32 861 4 x		35 797 1 x		38 246 4 x
	31 848 6 x		32 869 1 x		35 998 2 x		38 249 1 x
	31 888 2 x		32 879 6 x		36 298 2 x		38 260 2 x
	31 891 4 x		32 881 8 x		36 323 18 x		38 261 4 x

Einzelteilübersicht
Spare parts list
Liste des pièces détachées



	38 413 1 x
	38 423 4 x
	38 428 9 x
	38 541 3 x
	38 545 4 x

Onderdelenoverzicht
Lista da piezas
Resumo de peça individual

	38 546 2 x
	106 766 4 x
	122 267 1 x
	122 646 4 x
	122 648 1 x

	122 900 1 x
	122 950 1 x
	123 536 1 x
	123 539 1 x
	130 593 1 x

Singoli componenti
Перечень деталей
零件概览

	142 251 1 x
	143 231 1 x

Montagetipps
Tips for assembly
Tuyaux pour le montage

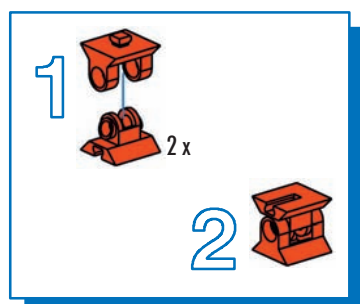

Montagetipps
Consejos para el montaje
"Dicas" para montagem

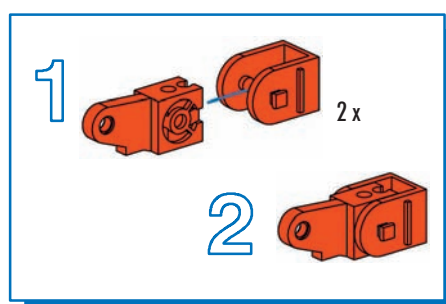

Consigli per il montaggio
Советы по сборке
装配建议

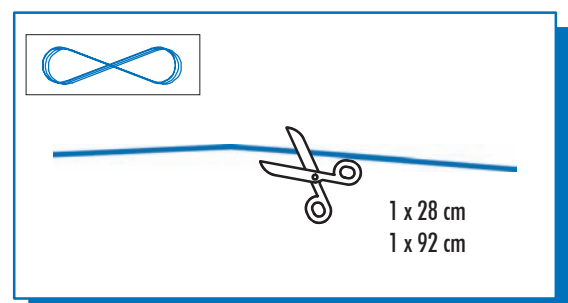
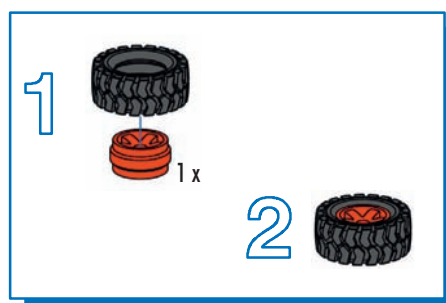
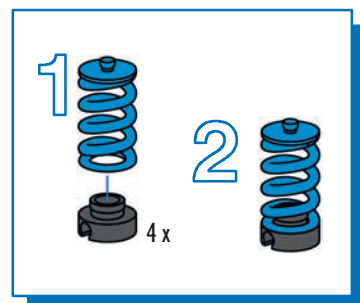
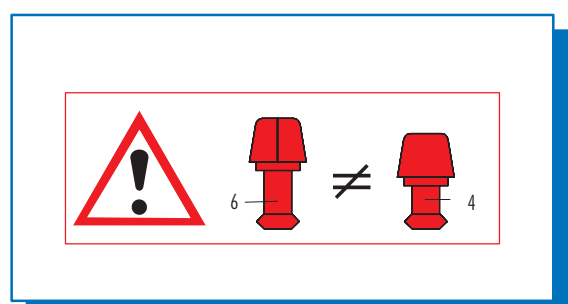

- Bei der Reifenmontage Profilrichtung links und rechts beachten!
- When mounting the tyres, please pay attention to the direction of the tread, left and right.
- Pour le montage des pneus, faire attention à la direction gauche et droite du profil.
- Let bij de bandenmontage op de profielrichting links en rechts.
- Al montar los neumáticos, tener en cuenta la dirección del perfil izquierdo y derecho.

- Ao proceder a montagem de pneus, levar em conta a direcção de perfil à esquerda e à direita.
- Al momento del montaggio delle gomme si deve osservare la direzione del profilo (a sinistra e destra)!
- При монтаже шин обратите внимание на правое и левое направление протектора!
- 装配轮胎时应注意左右轮胎沟纹的方向！

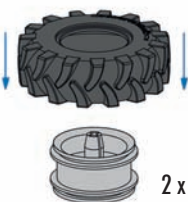

links
left
gauche
links
izquierda
à esquerda
sinistra
левое
左

2 x



rechts
right
droite
rechts
derecha
à direita
destra
правое
右

2 x