

Inhalt
Contents
Contenu

Inhoud
Contenido
Conteúdo

Contenuto
Содержание
目录

Einzelteilübersicht / Spare parts list / Liste des pièces détachées / Onderdelenoverzicht / Lista da piezas / Resumo de peça individual /
Singoli componenti / Перечень деталей / 零件概览 2

Montagetips / Tips for assembly / Tuyaux pour le montage / Montagetips / Consejos para el montaje / "Dicas" para montagem /
Consigli per il montaggio / Советы по сборке / 装配建议 3

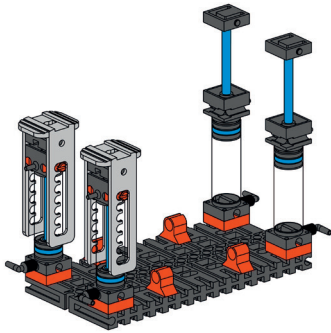

Demomodell / Demo model / Modèle de démonstration /
Demomodell / Modelo de demostración / Modelo de demonstração /
Modello dimostrativo / Демонстрационная модель /
演示模式 4

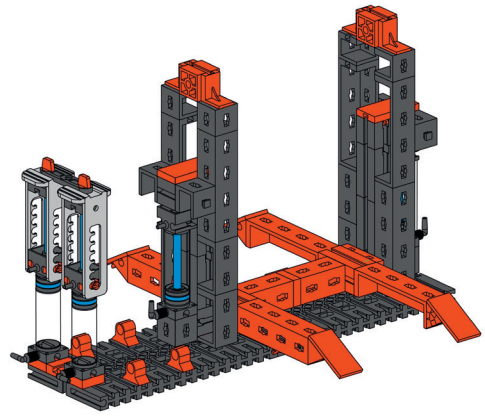

Hebebühne / Lift / Plateforme de levage / Hefplatform /
Plataforma elevadora / Plataforma elevatória /
Piattaforma di lavoro aerea / Подъемная платформа /
升降台 6

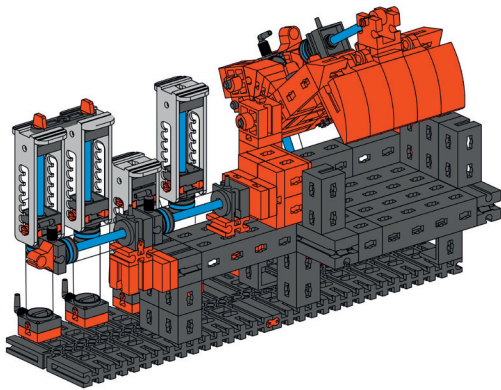

Schrottpresse / Car crusher / Presse à ferraille / Schrootpers /
Prensa de chatarra / Prensa de sucata / Pressa per rottami /
Пакетировочный пресс / 废钢打捆压力机 15

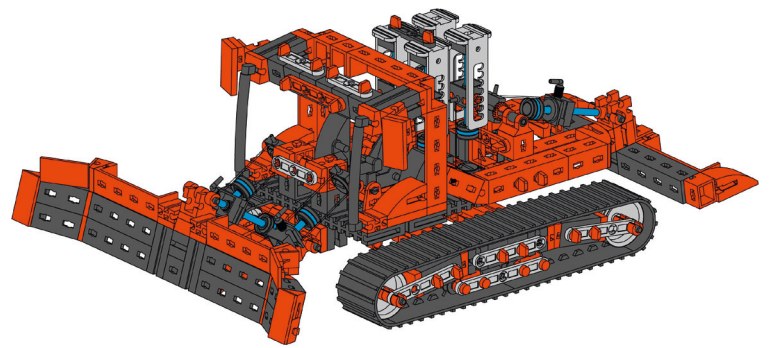

Pistenraupe / Snowcat / Dameuse / Pistenbully / Pisanieves / 
Niveladora de neve / Gatto delle nevi / Гусеничный
снегоуплотнитель / 雪道推平车 26

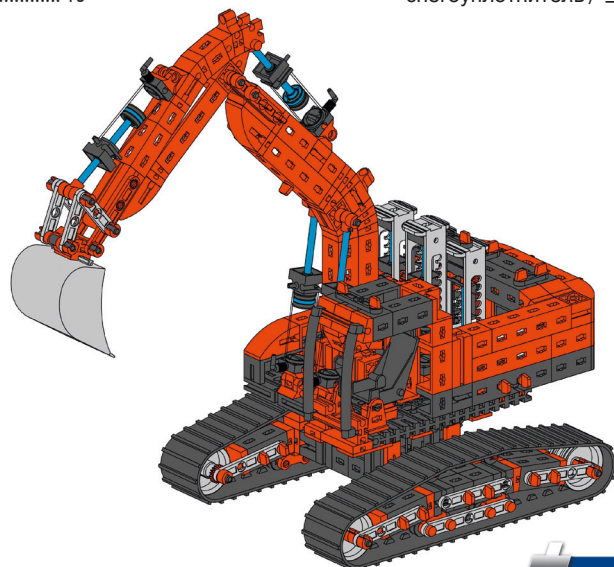













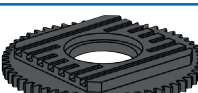
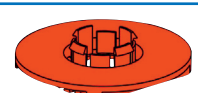

















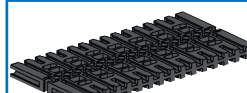

Raupenbagger / Excavator / Pelle sur chenilles / 
Rupsgraafmachine / Excavadora de oruga / Escavadora de
lagartas / Escavatore cingolato / Экскаватор на
гусеничном ходу / 履带式挖掘机 43











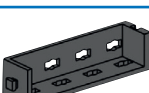

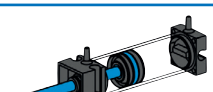



Einzelteilübersicht
Spare parts list
Liste des pièces détachées

Onderdelenoverzicht
Lista da piezas
Resumo de peça individual







Singoli componenti
Перечень деталей
零件概览

	31 010 2 x
	31 011 10 x
	31 060 3 x
	31 061 2 x
	31 390 1 x
	31 391 1 x
	31 422 4 x
	31 426 5 x
	31 436 7 x
	31 690 9 x
	31 848 12 x
	31 918 2 x
	31 981 8 x
	31 982 51 x
	31 983 1 x
	31 984 1 x
	31 994 2 x

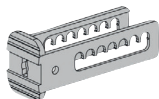
	32 064 7 x
	32 071 16 x
	32 085 4 x
	32 330 2 x
	32 879 8 x
	32 881 6 x
	35 049 2 x
	35 129 2 x
	35 969 6 x
	36 323 40 x
	36 324 4 x
	36 334 6 x
	36 586 4 x
	36 819 2 x
	36 912 4 x
	36 914 2 x
	36 915 8 x

	36 920 12 x
	36 921 6 x
	36 922 11 x
	36 938 8 x
	36 950 8 x
	36 973 6 x
	37 237 22 x
	37 238 5 x
	37 468 5 x
	37 636 2 x
	37 679 36 x
	38 240 2 x
	38 241 10 x
	38 246 1 x
	38 253 2 x
	38 258 12 x
	38 413 2 x

	38 414 4 x
	38 415 5 x
	38 416 1 x
	38 423 9 x
	38 428 4 x
	78 728 11 x
	116 251 4 x
	116 252 3 x
	116 913 4 x
	127 471 6 x
	127 472 6 x
	139 645 2 x
	146 985 2 x
	156 042 1 x
	156 104 1 x
	160 545 4 x
	160 546 10 x

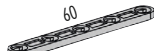
	163 203 4 x		173 040 4 x		173 043 2 x		
	163 439 7 x		173 041 4 x		173 044 6 x		
	172 809 2 x		173 042 1 x		173 045 2 x		

Montagetipps
Tips for assembly
Tuyaux pour le montage

Montagetipps
Consejos para el montaje
"Dicas" para montagem

Consigli per il montaggio
Советы по сборке
装配建议

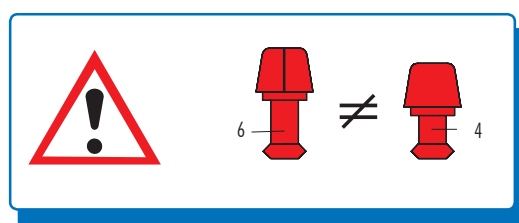
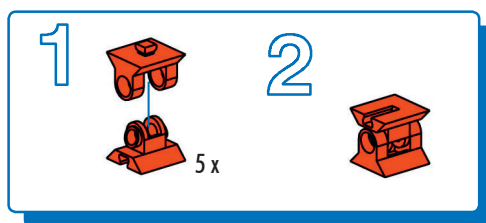
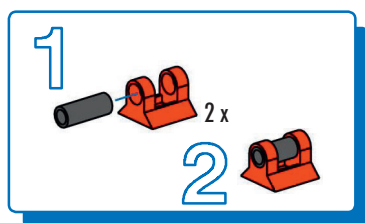
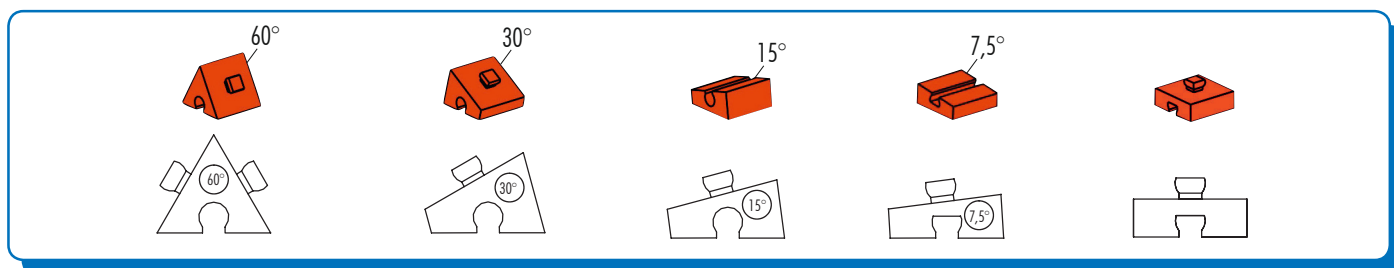

Schlauchzuschnitte
Hose cut to length
Découpes de tuyau

Slangdelen
Recortes de tubos flexibles
Recortes de mangueira

Spezzoni di tubo
Штуцеры
软管段

2 x 25 cm
1 x 35 cm
1 x 50 cm

Sicherheitshinweise
Safety Information
Consignes de sécurité

Veiligheidsrichtlijnen
Indicaciones de seguridad
Observações sobre segurança

Informazioni per la sicurezza
Указания по технике безопасности
安全指南

- Alle Einzelteile, insbesondere bewegliche Teile sind falls notwendig zu warten und zu reinigen.
- All components, especially moving parts, should be maintained and cleaned as necessary.
- Toutes les pièces détachées et en particulier les pièces mobiles, sont, si nécessaire, à entretenir et à nettoyer.
- Alle onderdelen, vooral de bewegende delen, kunnen, indien noodzakelijk, onderhouden en gereinigd worden.
- Es necesario limpiar y mantener en buen estado todas las diferentes piezas - especialmente las piezas móviles.
- Caso necessário, todas as peças individuais, especialmente peças móveis, tem que ser submetidas à manutenção e ser limpidas.
- Se necessario, tutti i singoli componenti, soprattutto le parti mobili, si devono eventualmente sottoporre a manutenzione e pulizia.
- Все детали, особенно подвижные, требуют ухода и чистки.
- 必要时应保养和清洁所有零件，尤指运动部件。

25 cm
20 cm
15 cm
10 cm
5 cm
0