

H.M. Brig-Sloop
Flirt 1782
Building Manual

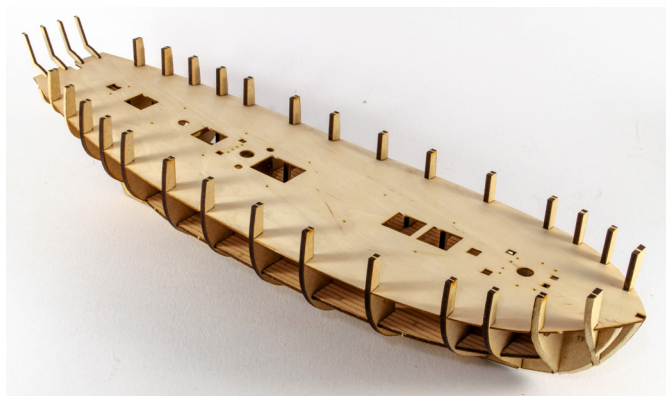

VANGUARD MODELS
BY CHRIS WATTON

HM BRIG-SLOOP FLIRT

HISTORY

The Flirt was ordered together with Speedy in 1781 and both built by Thomas King, a private shipyard owner based in Dover with Flirt being launched on 4th March 1782, three months before Speedy.

The Flirt/Speedy class of brig-sloops were the second class built to the new flush decked brig-sloop designs, the first being the Childers class of 1779 (Childers was in the very first action that led to the long war with France from 1793-1815, after being fired upon on 2nd January 1793 from a French battery based in Brest, a cannon ball from the battery being taken to the Admiralty in London). Both the Childers and Flirt/Speedy class were almost identical, and it would be difficult to tell the differences. Both were around the same dimensions, mast plans and armament and crew complement. They also shared the same very graceful lines, more cutter-like than brig. These early flush decked brig-sloops had a graceful sheer and steeply raked stern, unlike the later 'mass-produced' Cruiser and Cherokee classes.

The term 'Brig-Sloop' means that she was a two-masted vessel, and on the Navy List sloop was a term given to a vessel which was commanded by an officer with the rank of master and commander. Flirt was 207 tons, the length of her upper deck was just over 78 feet and her breadth was 25 feet, 8 inches. She had a crew of between 84 men and 6 officers, with only two of the officers being commissions, the commander and his lieutenant.

Her armament consisted of 14 x 4-Pounder carriage guns and 12 x half-pounder swivel guns, but posts for 20 guns, as the swivel guns could be taken out of their posts and moved and placed in another post.

Flirt and Speedy were completed too late to see any significant service in the American War of Independence. She then spent most of the years of peace in British waters. She sailed to Jamaica in 1791, but was laid up in Deptford in November 1792, and did not return to service before being sold in 1795. Daniel Bennett purchased her, had her almost rebuilt, and then employed her as a whaler in the Southern Whale Fishery. A French privateer captured her in 1803 as Flirt was returning to Britain from a whaling voyage.

Commander Nathan Brunton commissioned Flirt for the North Sea in March 1782. She was then paid off in 1783, but recommissioned in April under Commander William Luke and stationed between Beachy Head and the Isle of Wight. She remained on that station through the tenure of her next two captains.

Flirt was paid off in 1786 before Commander Piercy Brett recommissioned her in May. Commander John Stevens Hall replaced Brett in 1788, only to have Commander James Norman replace him in 1789. Norman recommissioned her in May 1790 for the Spanish Armament. George Bass, who would go on to achieve fame as an explorer, qualified as a surgeon for a first-rate (as a 13-year old), but his first appointment was to Flirt.

Commander James Nicoll Morris recommissioned Flirt in May 1790 for the Channel. He sailed her for Jamaica on 22 November 1791. However, after she returned to Britain she was laid up at Deptford in November 1792.

The Principal Officers and Commissioners of His Majesty's Navy offered the "Hull of His Majesty's

Sloop Flirt. Burthen 200 tons, copper fastened, with Copper on her Bottom", for sale at Deptford on 1 December 1795. Flirt sold on that day for £450.

Daniel Bennett, the owner of several whalers purchased Flirt and had her almost rebuilt in 1796. Captain Thomas Dennis first sailed Flirt in the South Seas Whale Fishery in 1796. Between 1796 and 1801 she was reported to be whaling off Walvis Bay. During this period she returned to Britain in January 1798, but sailed again on 2 February for the East Coast of Africa. By May was in Rio de Janeiro replenishing her supplies of water and provisions. She then returned to Britain on 16 November 1799. On 20 November 1799 Captain Gardner sailed to East Coast of Africa. Flirt left St Helena in August 1800 and was back in London by 16 October. Captain T. Bunker was reported at Walwich Bay (Walvis Bay) in August 1801. She returned to Britain 4 December.

In 1802 she was again whaling off the East Coast of Africa. At the time she was valued at £8,000. In August 1802, the Honourable the Court of Directors of the East India Company announced that they had licensed 19 vessels, Albion, Charming Kitty, and Flirt among them, to sail east of the Cape of Good Hope to engage in whaling in the "Southern Whale Fishery".

In 1802 "Warren" replaced Bennett as owner of Flirt. At the time her captain was J. Anthony. This arrangement of Warren as owner and J. Anthony as master continued into 1803.

In June 1803, the French privateer captain François Aregnaudeau took command of the 32-gun 550-ton corvette Blonde, from Bordeaux. He had a successful cruise, most notably capturing the East Indiaman Culland's Grove on 22 July. He also captured Flirt as she was returning to London from whaling. On 3 August Aregnaudeau took both prizes into Pasajes, and any further mention of Flirt is lost to history.

Although not as glorious a career as her sister, Flirt certainly had a very long and varied career.

References

- Clayton, Jane M. (2014) Ships employed in the South Sea Whale Fishery from Britain: 1775-1815: An alphabetical list of ships. (Berforts Group). ISBN 978-1908616524
- Demerliac, Alain (2004). *La Marine du Consulat et du Premier Empire: Nomenclature des Navires Français de 1800 A 1815* (in French). Éditions Ancre. ISBN 2-903179-30-1.
- Stanbury, Myra, Kandy-Jane Henderson, Bernard Derrien, Nicolas Bigourdan, & Evelyne Le Touze (2015) "Chapter 18: Epilogue" [online]. In: Stanbury, Myra. *The Mermaid Atoll Shipwreck: A Mysterious Early 19th-century Loss*. (Fremantle, WA: Australian National Centre of Excellence for Maritime Archaeology and the Australasian Institute for Maritime Archaeology): 235-290. [1] ISBN 9781876465094 [cited 20 Aug 18].
- Winfield, Rif (2008). *British Warships in the Age of Sail 1793–1817: Design, Construction, Careers and Fates*. Seaforth. ISBN 978-1-86176-246-7.

THE KIT

The Flirt kit has been researched to depict her as she most likely appeared at her launch in 1782, and before copper plating was added.

The model kit is designed to be as accurate as possible for a commercial kit in both scale and detail. Although the kit of Flirt is as easy to build as we can make it, very basic woodworking skills (and patience) are still required. Estimated build time is between 60 to 80 hours, so a work space will have to be put aside for the job. Do not remove parts from the laser cut sheets until actually required for fitting, as they can be easily damaged or lost.

Take plenty of time to study this manual until you are confident enough to tackle each stage of construction. Patience is the key word when building any scale model. Treat each stage as a separate project and the overall effect of the completed subject will be much enhanced.

Care should be taken when cutting parts from the laser and brass etched sheets. The sheet from which you are going to cut the parts should be laid on a hard, flat surface. Use a heavy duty craft knife (a Stanley Knife is perfect and is and always has been my staple for all manner of cutting) with a good strong blade to cut through the tabs holding the parts in place. Before removing the wooden parts from their sheets, they should be numbered by reference to the cut file identification drawings. It is easier to paint most of the photo-etched parts before removing them from their sheets. They can be touched up again once in place on the model.

The metal cannon balls should be blackened before gluing in place. You can either paint them or blacken them using a solution for brass burnishing, which is listed below.

When painting parts in wood, use multiple coats with fine sanding in-between each coat to help minimise the grain visibility. Never settle on just a single coat, but take your time with every single sub assembly. Regarding the main wale and run of the hull planking, the main wale was actually part of the main planking, except the wale was thicker. Many models show the wale with a different curve to the main hull planking, when in fact it should run at exactly the same lines as the main planking. This can detract from the overall finish of the completed model. This is why I recommend starting the second planking at main wale level, as this guarantees the run of both main wale and second planking will be the same.

I have included a building cradle on the 3mm MDF laser sheet that is for use when building the model, marking the waterline etc. Do not make up the clear acetate cradle until the model is complete.

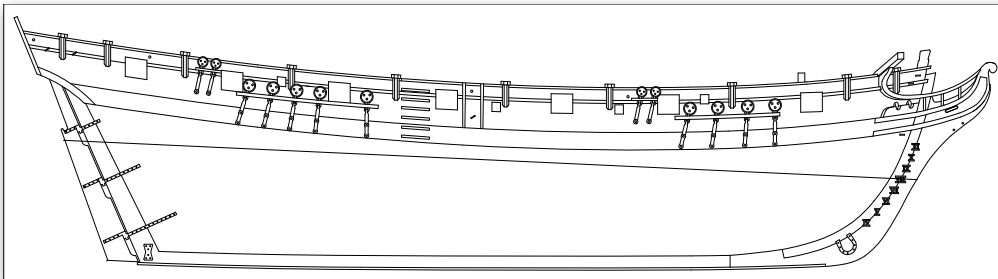

RECOMMENDED TOOL LIST

(All items listed were used by the modeller to build the Flirt prototype model)

- 1: Craft knife (or standard Stanley Knife, which is robust enough for most jobs)
- 2: A selection of needle files
- 3: Razor saw
- 4: Small wood plane
- 5: Pin vice or small electric drill (the latter is the more recommended item)
- 6: Selection of drill bits from 0.5mm to 2mm
- 7: Selection of abrasive paper and sanding block
- 8: Selection of good quality paint brushes
- 9: Pliers/wire cutters (Good quality side cutters are excellent for trimming rigging ends)
- 10: Good quality set of tweezers (For small parts and rigging)
- 11: Steel ruler (300mm - for providing a straight edge for tapering the planking)
- 12: Clothes pegs or small clamps
- 13: Good quality pencil or drawing pen
- 14: Masking tape (Tamiya masking tape is perfect for masking areas around the main wale)
- 15: Waterline marking out tool
- 16: A Pin Pusher (Or you can just use a pair of pliers to push pins into the planking and bulkhead edges)
- 17: Cutting mat

Although not strictly required, access to a lathe would be very beneficial for turning the upper masts and yards, although the yards are easily tapered using a small wood plane and abrasive paper to smooth the surface.

PAINTS, STAINS AND ADHESIVES

- 1: White PVA wood glue
- 2: Cyanoacrylate (superglue) thick and medium viscosity
- 3: Natural colour wood filler
- 4: Indian ink (Black for ratlines)
- 5: Matt polyurethane varnish (Not satin or gloss)
- 6: Black paint (Humbrol 85) 3 tins or Vallejo matt black
- 7: Yellow paint (Ochre) (Humbrol 24) 1 tin
- 8: Red paint (Humbrol matt 60 for inside of bulwarks, cannon carriages and various deck fittings)
- 9: White Paint (For hull below waterline)
- 10: Metal burnishing/blackening liquid (AK Interactive AK 174 - brass Photo etch Burnishing) or similar
- 11: Clear Epoxy Resin or similar to glue the clear acetate stand together



HULL CONSTRUCTION

Before we begin, we need a cradle to hold the hull during the various construction stages. Instead of using your acrylic cradle, we've included an MDF one which you can dispose of when the model is built.



1. To remove the various parts from the sheet, use a sharp knife such as a Stanley Knife or a fresh scalpel, as shown in this photo. All parts are held in place with small tabs that are easy to cut through and minimise clean-up on the model parts. We have tried to put those tabs in areas that generally won't be seen.



2. Remove all bulkheads, 2 – 16

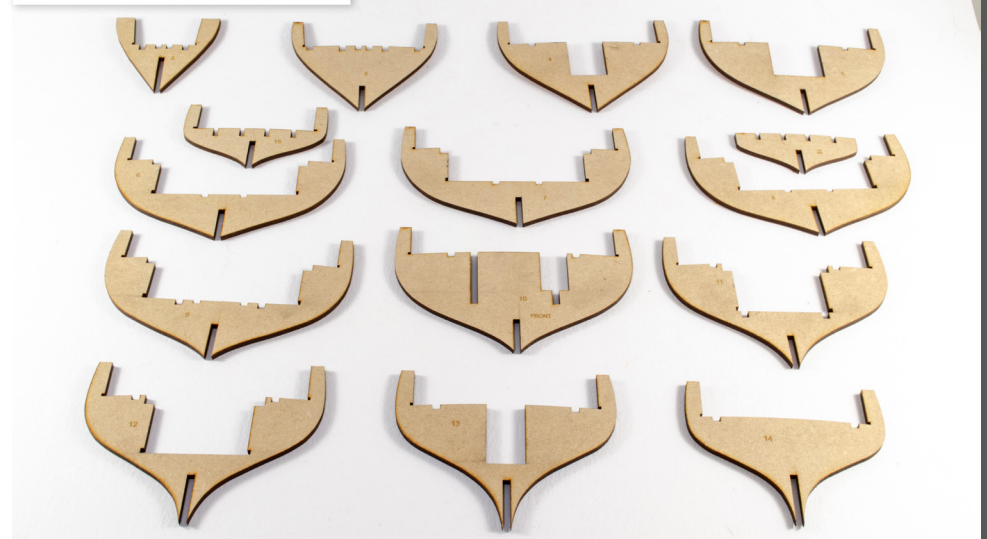

3. Now remove the large False Keel (1) and the two Fore/aft lower deck step patterns (22).

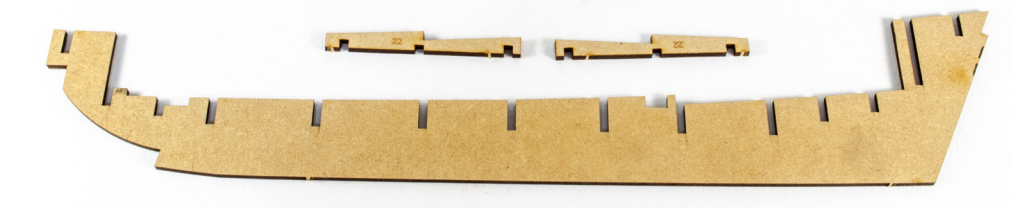

4. Using white glue, slot bulkheads 4 – 13 into place. Take note of the position of these from your plans, and also ensure that 10 is the correct way around. This is identifiable by the part having the word 'FRONT' engraved upon it.



Note orientation of Bulkhead 10



5. Slot the two Fore/aft lower deck step patterns (22) into place as seen here. When fitted, each stepped edge will be in line with each of the deck levels, as illustrated here.

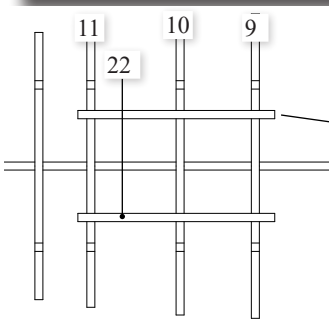
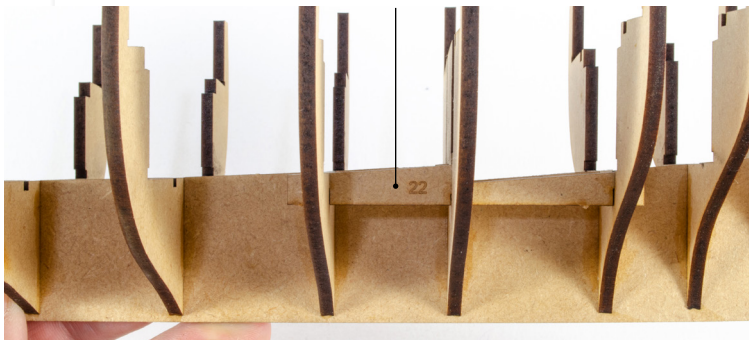

6. For HMS Flirt, we have introduced a laser-engraved lower deck. Remove Lower Deck Fore (28) and Lower Deck Aft (29) from the sheet. There are two of each part.

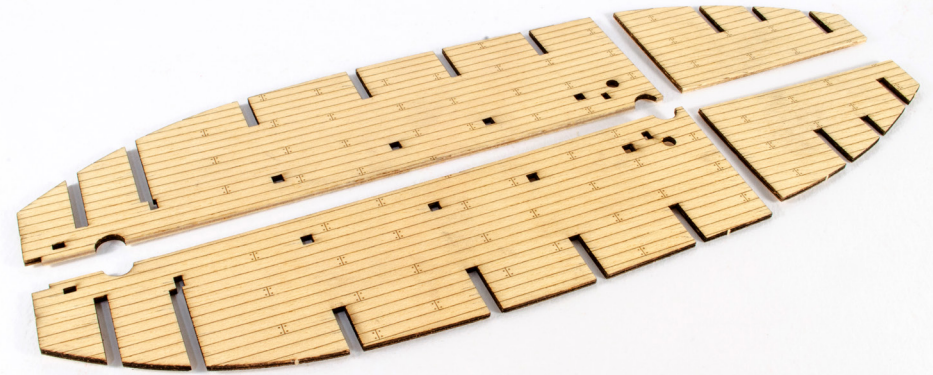

7. Add white glue to the areas shown in the photograph so you can fit half of the Lower Deck Fore (28). As some modern white glues can dry very quickly, we will add glue for one panel at a time.



8. Now fit the corresponding deck section into place. These will only fit one way, and it should be fairly obvious. If in doubt, dry fit to test before applying glue. The outside edges of the deck lock into a notch in each bulkhead. You may want to either pin the middle or apply weight whilst the glue sets..



9. Once the Lower Deck Fore (28) parts are in place, turn your attention to the two Lower Deck Aft (29) sections. Glue into position as shown here.



11. For some extra reinforcement, you can also brush some glue underneath the deck, and especially around the outer edges. This will provide a solid edge for when you later fair (sand) the outside hull.

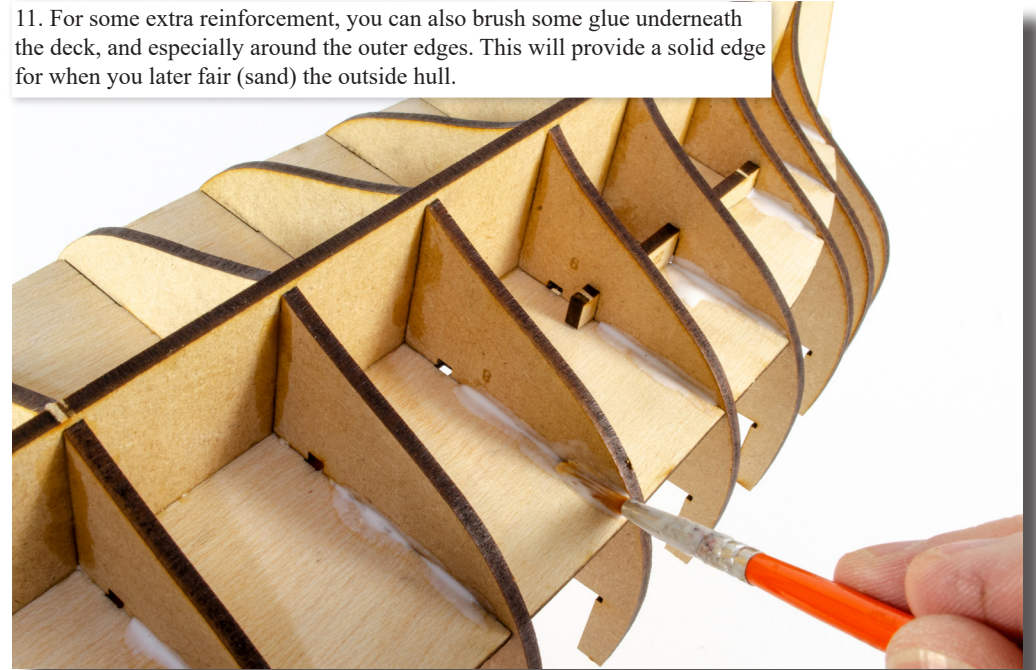

10. With all lower deck sections in place, this is what your Flirt hull should look like so far.

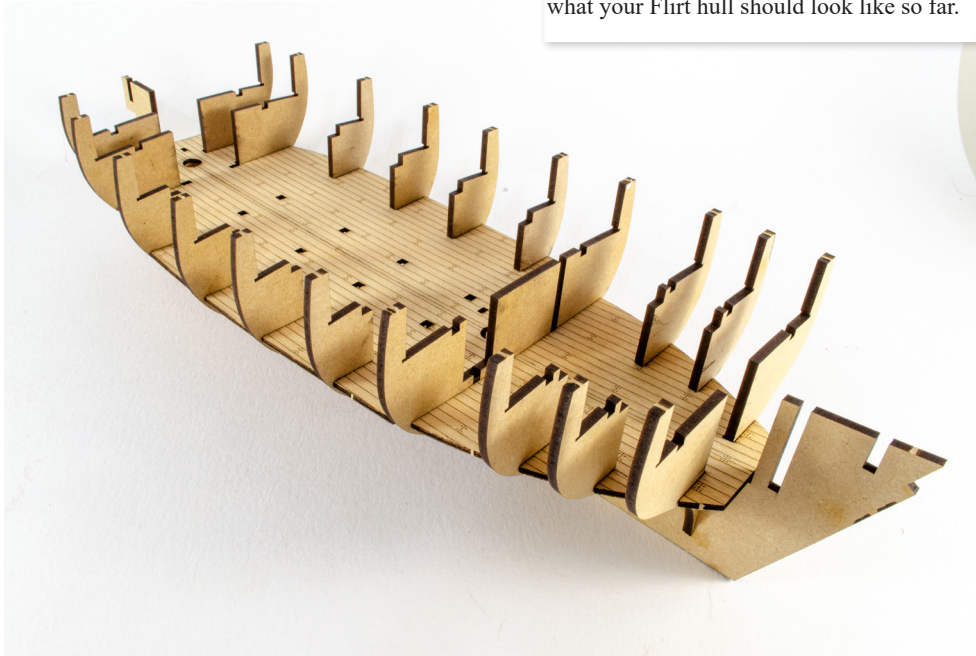

12. We have provided a small door to fit the doorway opening on bulkhead #10. Remove the Door to Captain's Cabin (10A) from the 1mm wood sheet and fit either a brass pin (F5) or a Closed Eyebolt (PE15) to replicate a door handle. Glue the door into position as shown here.



13. A small number of parts must now be bevelled before installation. These parts have engraving lines etched on them. Bevel bulkheads 2 and 3 that you previously removed from the MDF sheet, and also the two Bow Pattern Inner parts (17) and the two Bow Pattern Outer parts (18). These can be bevelled using either sandpaper, files or a rotary tool. For the prototype, we used a Dremel set on a safe 9000 rpm.



14. Your bevelled parts should look like this. This is only rough beveling, so just do the best you can with this beveling at the moment. These will be properly bevelled when the hull shape is sanded.

15. Bulkheads 2 and 3 can now be glued into place on the bow area of the False Keel (1).

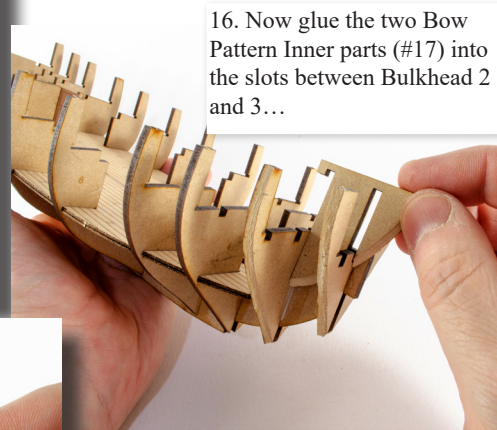
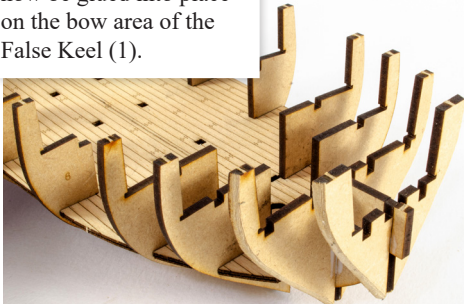

16. Now glue the two Bow Pattern Inner parts (#17) into the slots between Bulkhead 2 and 3...



17... followed by the two Bow Pattern Outer parts (18), as shown.

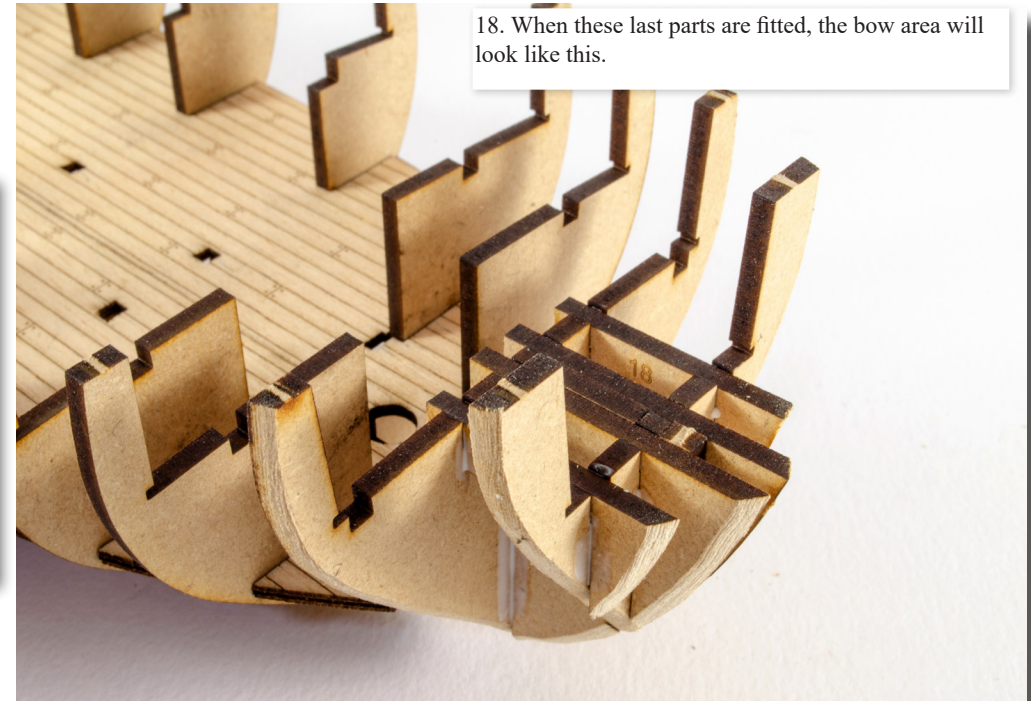

18. When these last parts are fitted, the bow area will look like this.

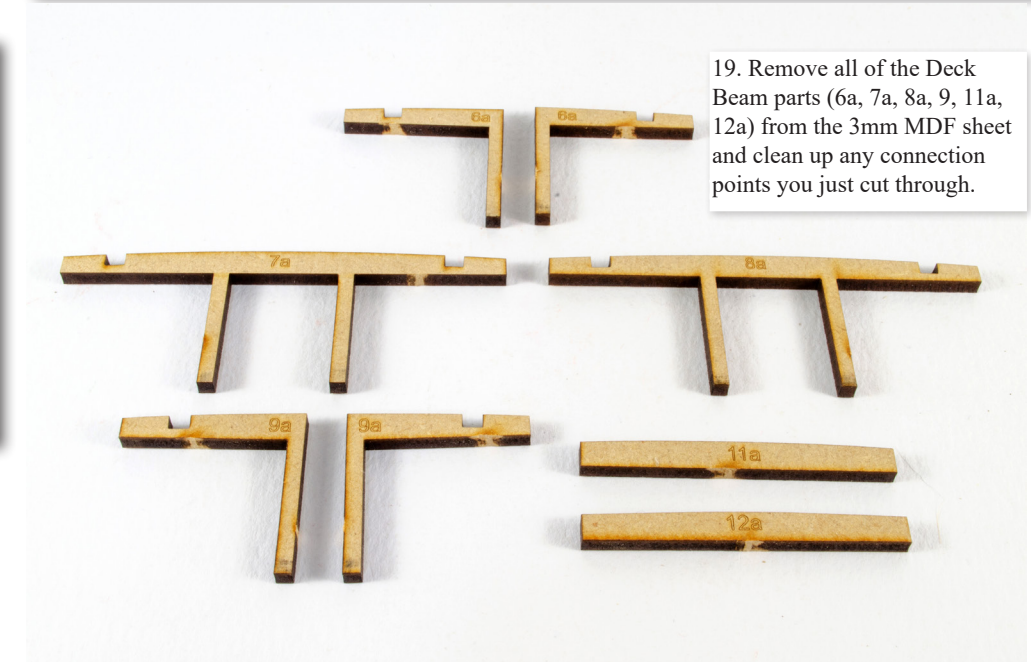

19. Remove all of the Deck Beam parts (6a, 7a, 8a, 9, 11a, 12a) from the 3mm MDF sheet and clean up any connection points you just cut through.

20. Glue all Deck Beams into their corresponding positions. For example, parts #6a fit onto Bulkhead #6 etc. Ensure all parts are properly seated and aligned.

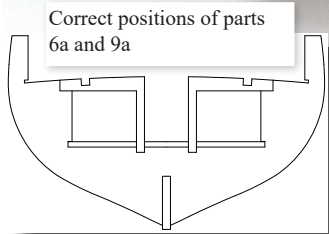

Correct positions of parts 6a and 9a

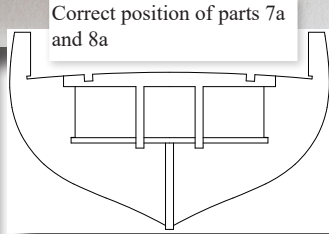

Correct position of parts 7a and 8a

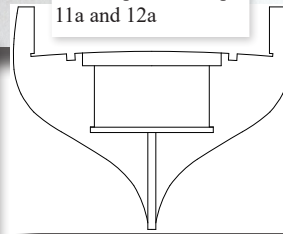

Correct position of parts 11a and 12a

21. Previously bevelled Bulkheads 14, 15 and 16, can now be glued into position at the stern of the hull, noting that the bevelled edge faces rearwards.

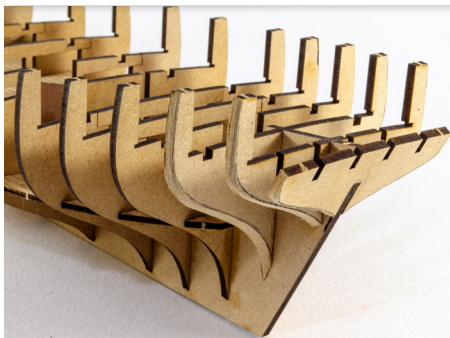

22. Cut the Bow and Stern Patterns (19, 20, 21) from the 3mm MDF sheet and bevel them as shown here. This doesn't need to be too accurate as they will be properly bevelled once glued to the model.



23. Take a sanding stick or sandpaper and level the top of Bulkheads 14, 15 and 16, and sand it so it's level with the top of the False Keel (1). As long as none of the bulkheads protrudes above that level, this is OK.

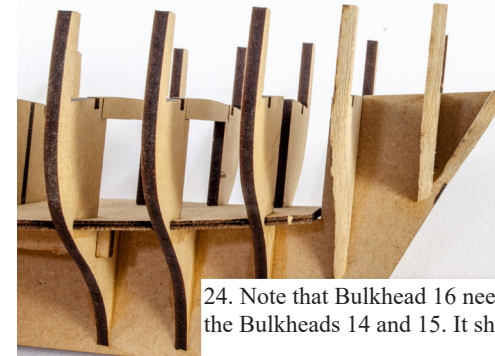

24. Note that Bulkhead 16 needs more sanding than the Bulkheads 14 and 15. It should look like this.

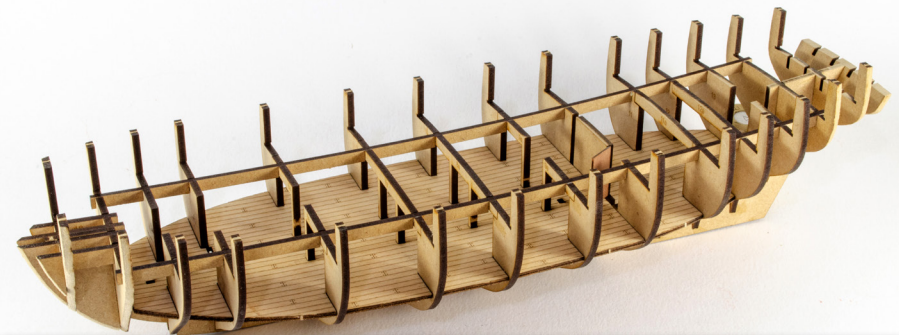

25. Remove the Upper deck longitudinal support parts (23) from the 3mm MDF sheet and glue them into place as shown. Test fit them first, so you know you have them in the correct orientation. These parts lock into slots in the top of the bulkheads.

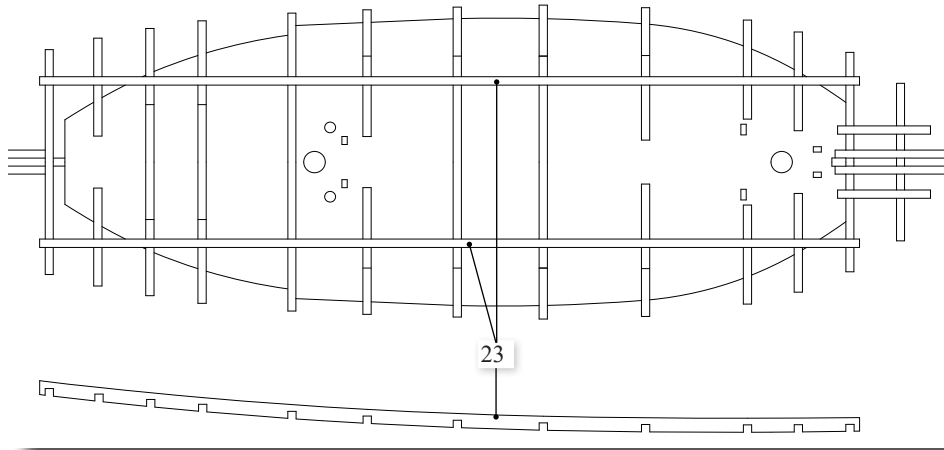

26. Now glue the Bow Pattern 20 between Bulkheads 2 & 3, and Bow Pattern 19 between Bulkheads 3 & 4, as shown in this photo.

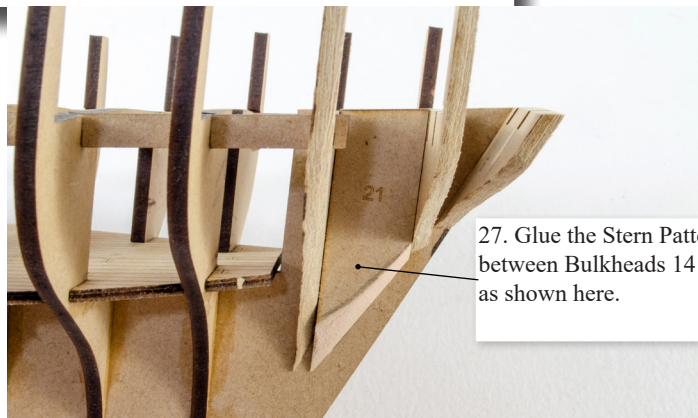

27. Glue the Stern Pattern 21 between Bulkheads 14 & 15, as shown here.



28. Remove the two Stern Frame Pattern (Inner, 30), and the two Stern frame Pattern (Outer, 31) from the 2mm birch plywood sheet.



29&30. Glue the Stern Frame Patterns into their relative positions at the stern, making sure you push the parts fully into position as seen in this photograph.

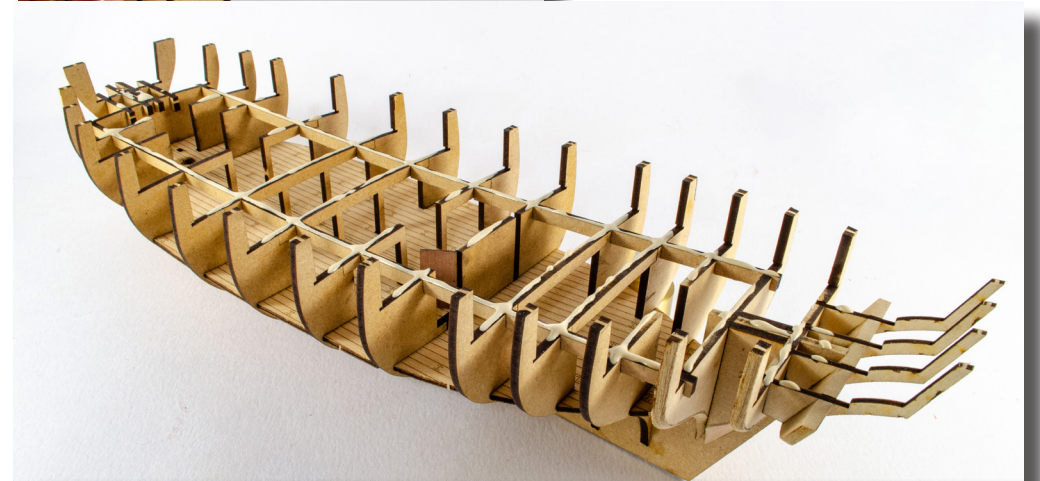

31&32. The Main Deck 36 can now be glued into position. Run beads of glue over the top of the bulkheads, deck beams and the two longitudinal supports. Now take the Main Deck and gently flex it into a curve and slot it into the bulkheads on one side of the hull. Be careful not to break any of the bulkhead tabs above the deck. The deck edge slots into the recess at in the bulkhead tabs. This will hold the deck in position without needing to pin it. Now slot the other side of the deck into position in the same way. Work your way around the deck edges to make sure the deck is slotted properly. Once done, leave the glue to dry for 24hrs.

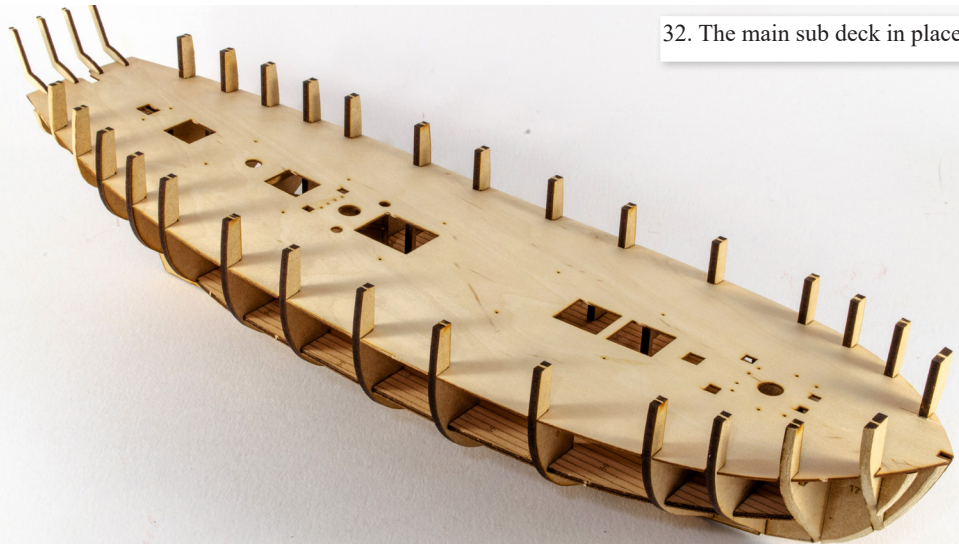

32. The main sub deck in place

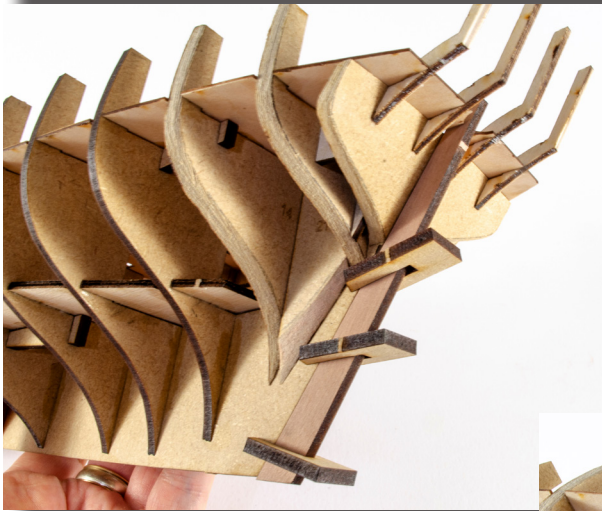

33. Remove the Stern/Rudder Post 126 from the 3mm wood sheet and temporarily hold in position at the stern with Securing Pegs 24. DO NOT GLUE anything in position here.

34. Take the Stern Counter 38 from the 0.8mm Ply sheet, and glue into position as shown. The temporary Stern/Rudder post will simply help to make sure you align the stern counter in the correct position. You may wish to soak the Stern Counter in hot water for 30 minutes to make it more pliable. We recommend that you use CA gel for this as you will have a few seconds to position it correctly, and you also won't need to pin into the thin frames.



35. The next task here is to remove the Stern Board 53 from the 1mm Wood sheet and fit this onto the stern frames, above the Stern Counter, as seen here. We suggest you use white glue (PVA etc.) for this as there is little curve in the part. You can clamp this until dry using small clamps or pegs etc.

36. Before the hull can be planked, it needs to be sanded smooth. This allows the planks to run freely over the hull with maximum contact on the bulkhead edges. As we have already bevelled the bow and stern bulkheads, this task shouldn't take too long.



37. Carefully sand the edges of the stern patterns so that the lower counter edge is flush with the deck edge. Also give the fore and aft bulkheads a final sand for the gun port patterns and planking to have maximum contact with the edges of the bulkheads. It is also a good idea to evenly thin the MDF where the stern post will fit. On our prototype, we thinned this down to about 1mm. To do this, mark a pencil line right down the middle of this length so ensure you thin this evenly. We also tapered the bottom of the False Keel in towards the sternpost location, thinning the deadwood area too.



38. Hull now ready for first planking

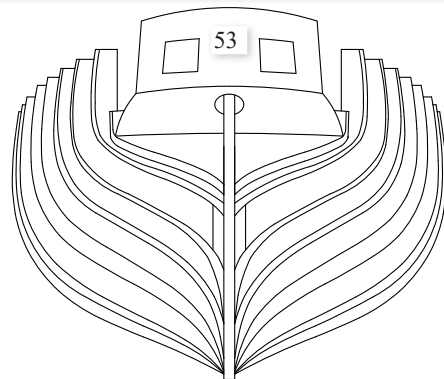
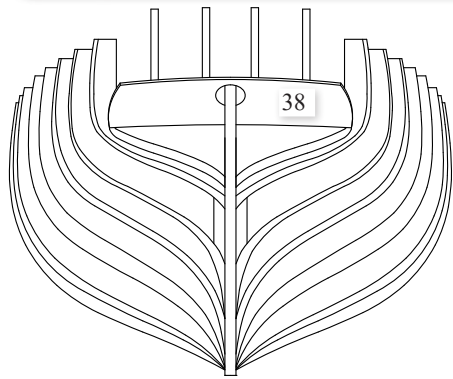
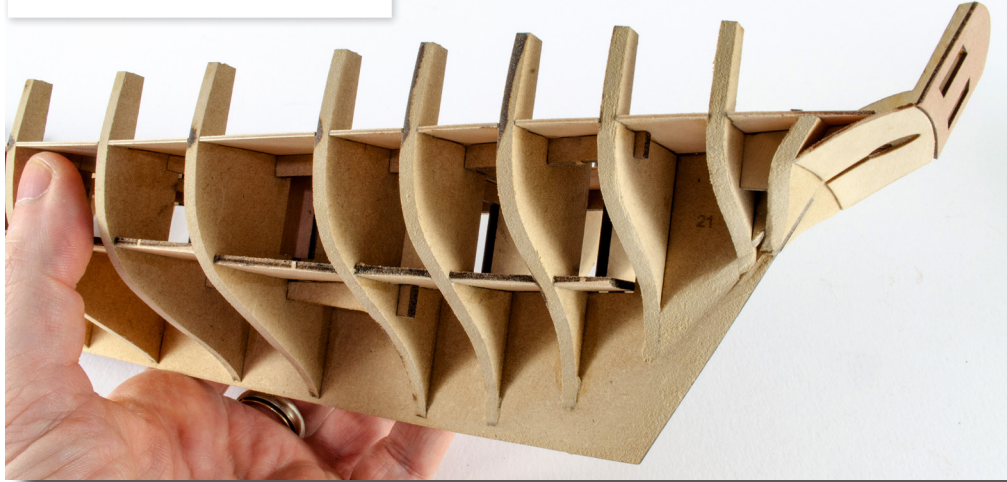

39. Take a strip of the 1.5x5mm lime-wood and lie this across the length of the hull in various positions to check that you have maximum contact and no bumps etc. If there are any imperfections, then gently sand the hull to remove them.

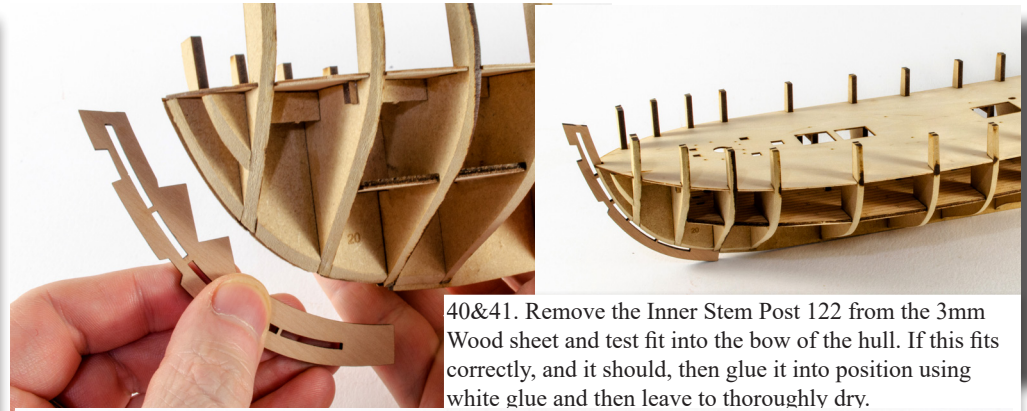
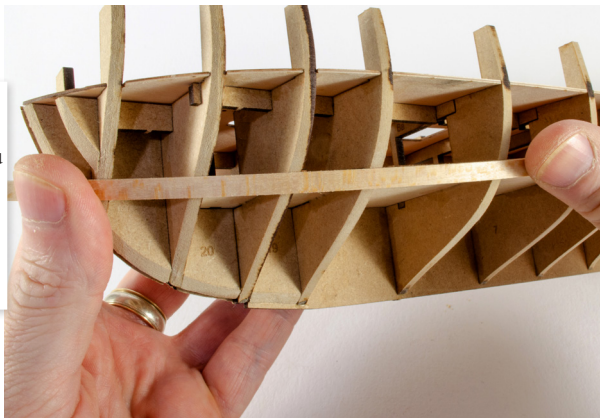

40&41. Remove the Inner Stem Post 122 from the 3mm Wood sheet and test fit into the bow of the hull. If this fits correctly, and it should, then glue it into position using white glue and then leave to thoroughly dry.

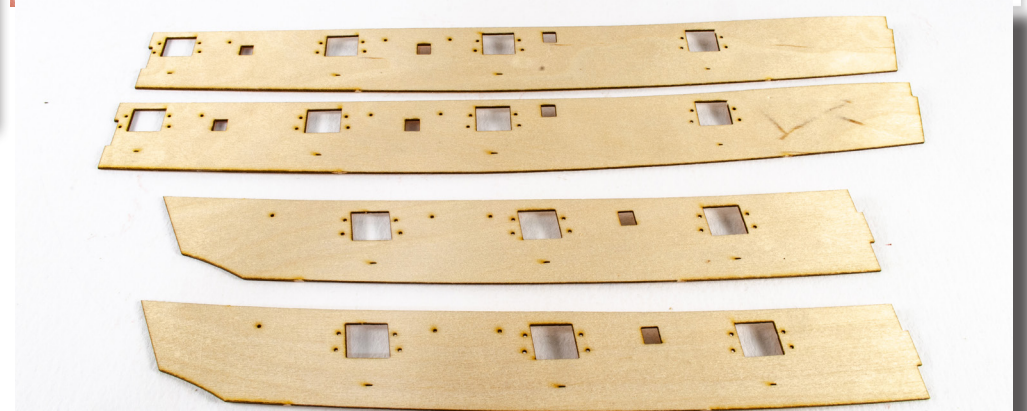

42. Remove parts 37 and 37a from the 0.8mm Ply sheets. These are the Side Bulwark Patterns, fore and aft.

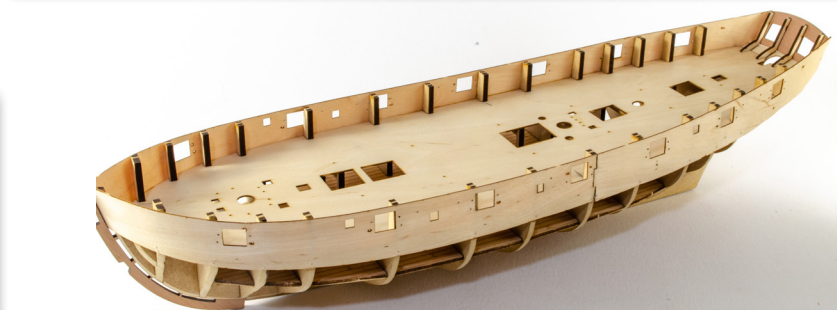

43. Soak the plywood Bulwark Patterns in hot water for about 30 minutes, to make them more pliable. When removed from the water, dry fit them to the hull using clamps until the parts have dried. The Fore Bulwark Patterns fit into the slots in the Inner Stem Post, as can be seen in this photo. When dry, glue them into position so the top of the Bulwark Patterns align as closely as you can with the top of the bulkhead tabs. Use a minimal amount of glue where the ply touches the bulwark tabs as these will later be removed. Use plenty of clamps to hold these in place until the glue is thoroughly dry.

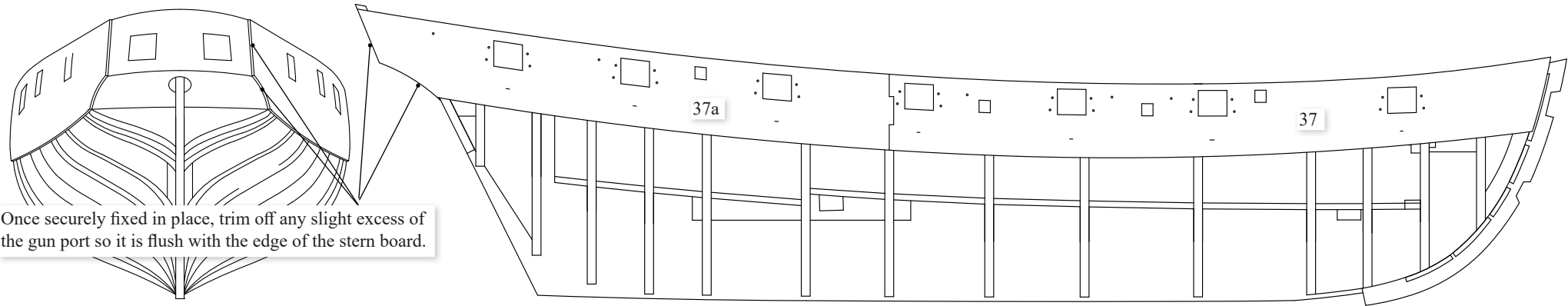

Once securely fixed in place, trim off any slight excess of the gun port so it is flush with the edge of the stern board.



44. We can now start the first layer of planking using the 1.5x5mm limewood strips. You will need to taper these planks as you fit them, otherwise they won't conform to the hull shape as you progress. This is a very easy task. First, lie your first plank below the plywood Bulwark Patterns and where the plank tries to overlap the ply, make a pencil mark. Do this at front and rear of hull. Put a rough forward and end mark on the plank too.

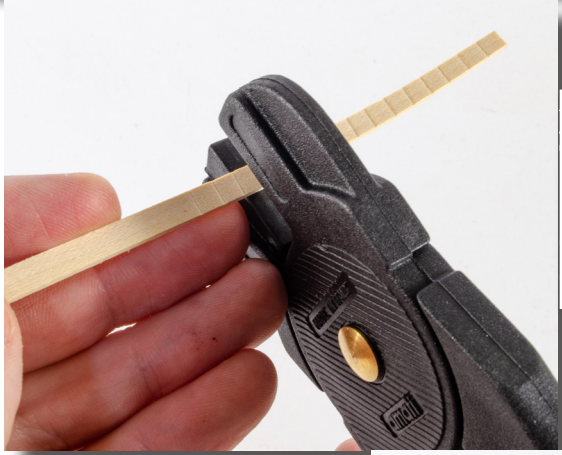

46. Another tool you can use to help form planks around curves is Amati's Plank Bender. This crushes the timber fibres on one side, forming a curve. The closer the marks are together, the tighter the curve will be. You can angle the marks too, to slightly twist the plank.

45. Make a pencil mark about 1/4 to 1/5 of way down from the width of the plank (at each end), and then taper using these two points. A very sharp knife is recommended, and also do this with several shallow cuts and don't try to cut through all at once. You also may wish to soak the plank before cutting as this can make tapering easier.



47. As you progress with your planking, you'll find that you will need to bevel the edges of them to ensure you don't have any edge-edge gaps. A sanding stick (shown) or a piece of medium grade sandpaper is advisable.





48. Glue this plank to the hull, pinning it with the supplied brass pins, where necessary. If you can, leave the pins protruding a little, as this makes it easier to remove them later. Repeat this process for the first plank on the opposite side of the hull. Now fit all subsequent planks in the same way, tapering as you go, and fit them alternately too as you progress. This helps prevent the hull from warping. To insert the brass pins, you can either use a pair of pliers, or a tool such as Amati's Nail Inserter. As you progress to bottom plank (garboard plank), you will need to fit the planks as they naturally run, so you may need to add slivers/triangles of wood to infill any gap. This is perfectly ok to do. Also note how I didn't run planks at the bottom of the deadwood. This would have just been sanded away anyway.

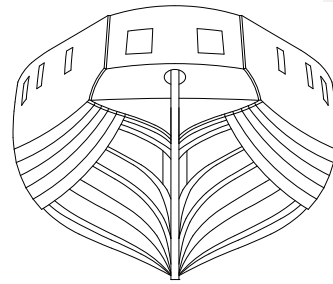

49. Remove all the brass pins and take a piece of 120 grit sandpaper (or similar) to sand the hull smooth, blending in the plywood Bulwark Patterns into the limewood planking.

50. All pins removed and hull sanded smooth, ready for the second layer of planking

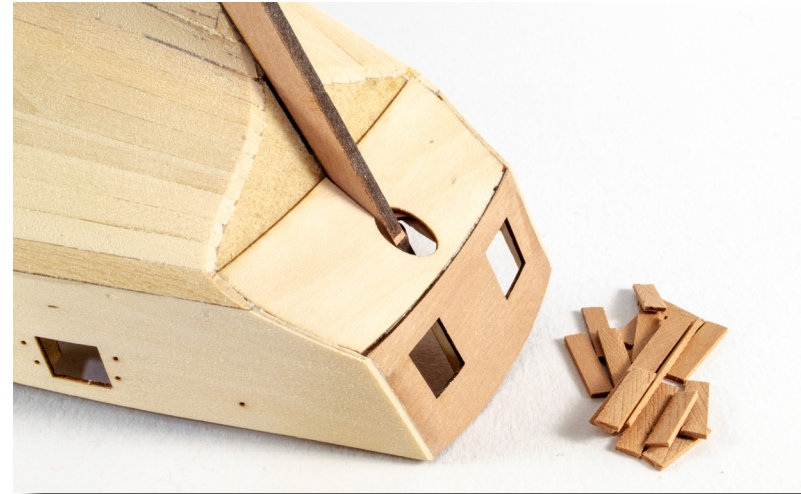

51. Trim the lime planking at the stern so it's flush with Bulkhead 15. Here you can see the thinned MDF where the sternpost will later fit.

53&54. Temporarily fit the Stern/Rudder post again (DO NOT GLUE!) and then take a strip of the 4mm x 1mm Second Planking F-33 and cut it into pieces. Plank the lower visible bulkhead as seen in this photo. You can then remove the Rudder/Sternpost.

52. Also trim and sand the end of the plywood Bulwark Patterns so they are flush with the Stern Board.

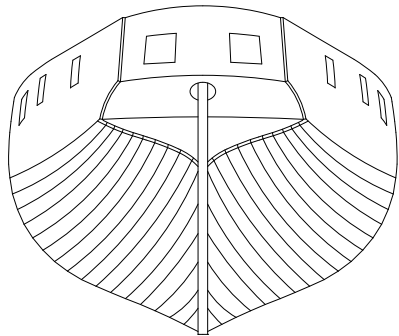

55&56. Now using the same F-33 planking strips, plank the remainder of the stern area, using the pattern shown in this manual. You can use CA or wood glue for this. When dry, sand it smooth and also sand flush to the edges.

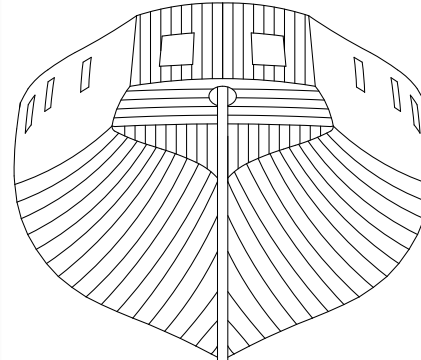

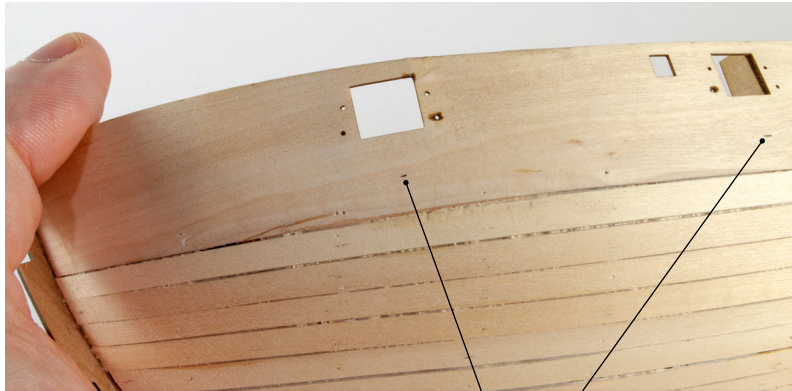

57. Note that underneath the cannon ports, there are small laser-engraved marks. These are to help you place the first plank of the second layer, or 'master plank'. You can circle these small laser marks for more clarity as you begin to add those planks to either side. The master plank will sit directly underneath these marks.



58. Take a strip of the second layer plank F-33, and cut an angle at the front, so suit the shape of the bow. Sand an inside bevel at that point so that it will push up snugly into that area without a gap. Now, this plank can be laid with either PVA wood glue or with CA gel. If you use wood glue, don't be afraid of using brass pins, as this plank will be eventually covered by the wale plank. On the prototype, I used CA gel as it gave me a good amount of time to position the plank, and a few seconds to correct any error in position. Fit the master plank to each side of the hull. Also make a small pencil mark on the Inner Stem Post which identifies the top of this master plank, for later in assembly.

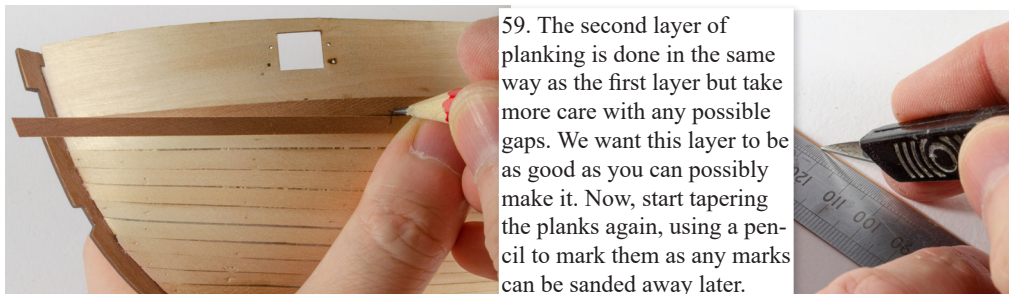

59. The second layer of planking is done in the same way as the first layer but take more care with any possible gaps. We want this layer to be as good as you can possibly make it. Now, start tapering the planks again, using a pencil to mark them as any marks can be sanded away later.



60. Work your way down the hull, tapering each plank at both bow and stern. I still tend to alternate the planks, although the hull is now very strong and not prone to warping. To glue this second layer, I used CA gel (Gorilla Glue), applied in a thin line from the nozzle. Don't apply too much as you don't want it to start oozing from between the planks, although we can sand that down later. If you need to use infill/stealers, this will be in the lower area of the hull, and it will be hidden by a layer of paint. Do NOT plank above the master plank at this stage. Also don't throw away the short end 'cut-offs' of planks as we can/will use them later. If you find that a plank needs to be soaked before fitting, you can do this in hot water, but it's not advisable that you glue it whilst wet, or shrinkage could occur after gluing.





61. Trim and sand the second layer planks at the stern so they are flush with the stern planking.



Hull below main wale planked and sanded smooth



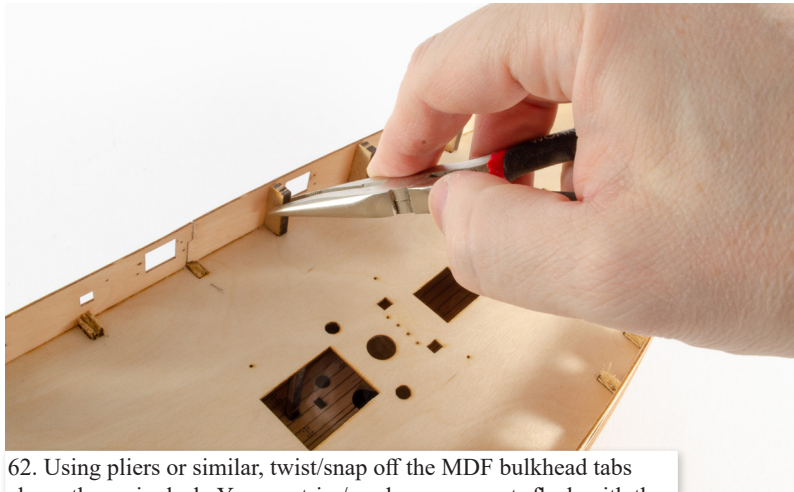

62. Using pliers or similar, twist/snap off the MDF bulkhead tabs above the main deck. You can trim/sand any remnants flush with the main deck. If you have any glue marks on the inner bulwarks, sand those away too.



63. Before you add the laser-engraved deck, the inner bow and stern need to be painted in a suitable red colour. It will be more difficult to do this later without accidentally getting paint on the deck. For this, I used Plastikote Red Oxide primer, after first masking off the rest of the hull with adhesive tape.

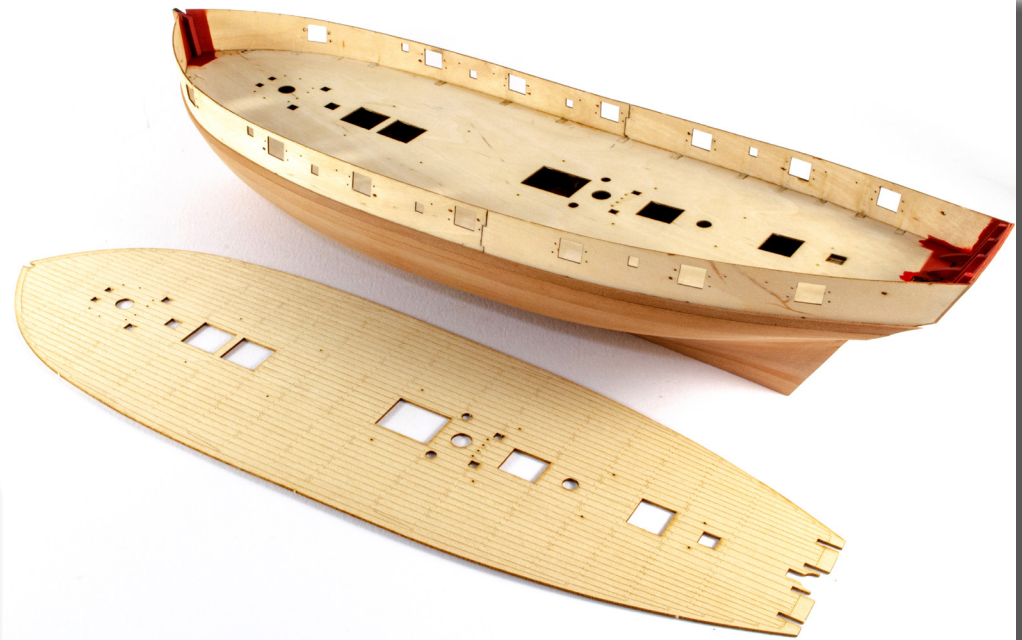

64. The laser-engraved deck can now be fitted over the ply deck. Test fit it first, and if you need to sand the edges at all, use medium grade paper. I now used wood glue, running thin beads around the edges of the deck and openings, and adding spots in other areas. The deck is then sat in position and a series of small clamps sat around the edges, holding it in position while it dried. If you do want to put weight on the middle area, please put some paper on the deck first to protect it from any marks.

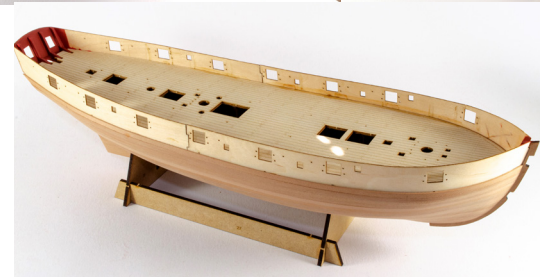



65. Using more strips of F-33, first paint these in the same red you used for the bow and stern interior and then begin to plank the inner bulwarks. It's acceptable to fit the lower plank in two pieces to make sure you get it to fit correctly. We recommend you use wood glue for this, and plenty of clamps whilst they dry. Work your way upwards, using some of those shorter plank lengths between the gun ports. Try to avoid gaps between planks too. On the prototype, I wasn't too happy with the overall appearance, so the deck was masked off and the bulwarks filled and sanded. Trim any excess timber away from the gun and oar ports.

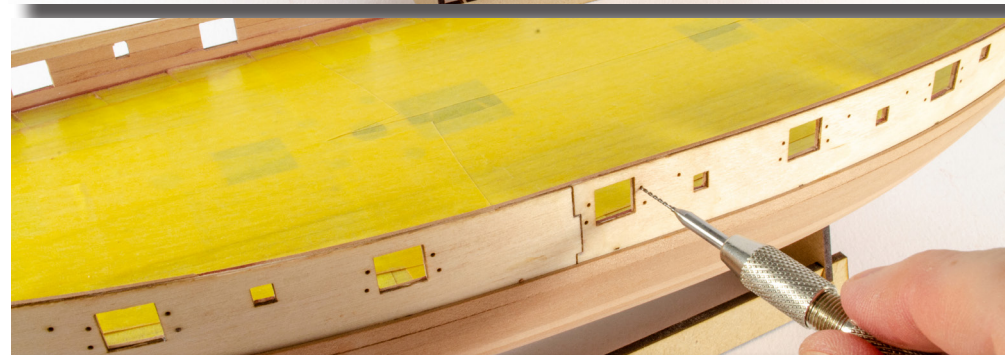

66. Use a 0.8mm drill bit and drill through the holes in the ply bulwarks, through to the inside. You may want to use a piece of scrap timber over the inside area to stop the bulwark timbers from splintering outwards. Once complete, finish planking the exterior of the hull. You won't need to taper these last planks. I also re-masked and reapplied the red bulwark paint. The entire hull exterior can now be sanded smooth.

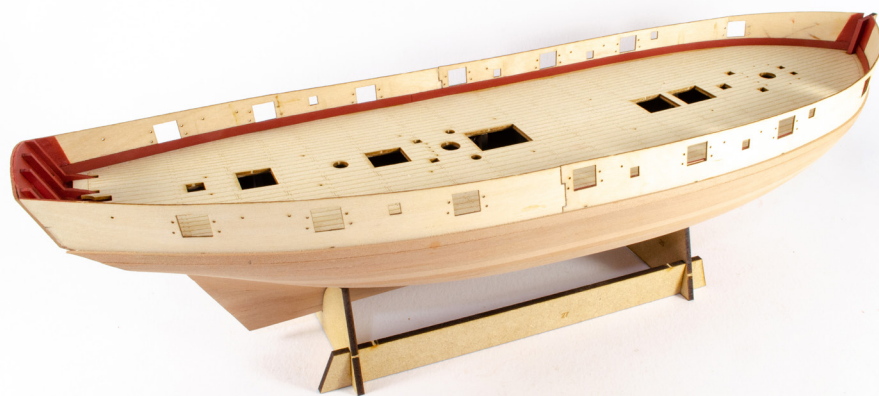



67. Referring to the small pencil mark you made which indicated the top of the master plank, add a series of pencil marks along the top edge of that master plank, and now take a 1mm x 3mm Second Plank strip F-34, and shape one edge to fit the bow, and run the plank up to the pencil marks you just added. This is the first wale plank. You can glue this with wood glue and pin it if you wish, as this will be painted black afterwards. For the prototype, I used CA gel. When the 1mm x 3mm strip is in place, fit a 1mm x 4mm F-33 strip directly underneath it. You may want to slightly bevel the edge of it to minimise any gap first.

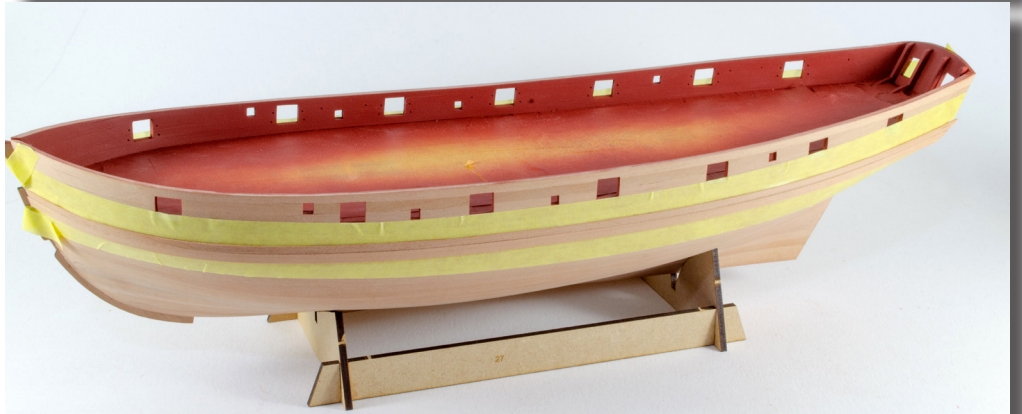
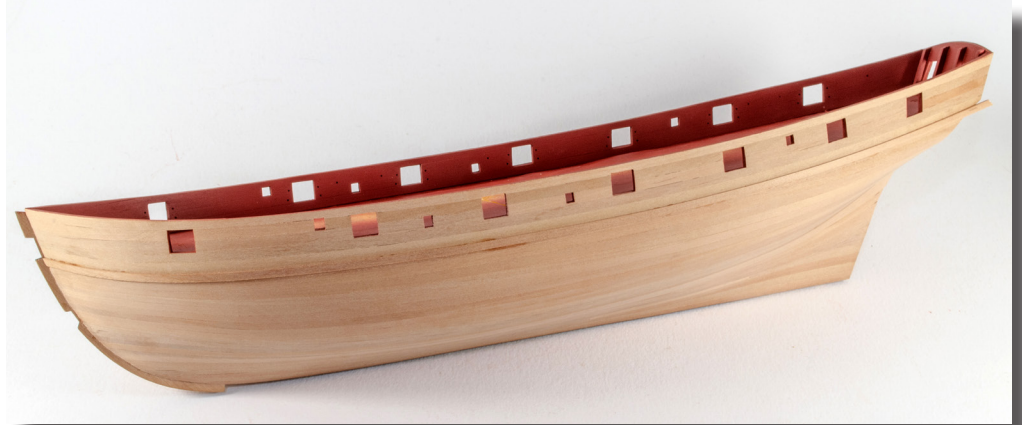

68. The hull is masked either side of the wales and the wales are then sanded to remove any edges or steps between the planks.



69. Remove parts 124, 124, and 125 from the 3mm Wood sheet. And clean up the connection tabs. Using wood glue, glue the Stem Pattern 123 into place at the bow, securing with the MDF pegs to ensure the part is properly aligned. Leave this to dry overnight and then glue the Fore Keel 124 and Aft Keel 125 into position. Again, use MDF pegs to help align. You can temporarily fit the Stern/Rudder Post to help with this. NOTE: if you intend to leave the bow in unpainted wood, remove the laser char from the top half of the Stem Pattern 123 before fitting.



70. Sand the top edges of the rudder so the squared edges are rounded off and remove the laser char from the top half of this part.



71. Remove the Rudder Gudgeon and Pintle Braces 8, 9, and 10 from the 0.2mm brass sheet and glue them into their relative positions as shown. Take a 0.8mm drill bit and then drill a few millimetres through the holes in the braces. Remove the Rudder Pintles PE-41 from the 0.6mm brass sheet and glue them into position in the holes, using CA.



73. Drill a 0.8mm hole in the top of the top of the rudder, in the position shown. This will be to fit the tiller arm.

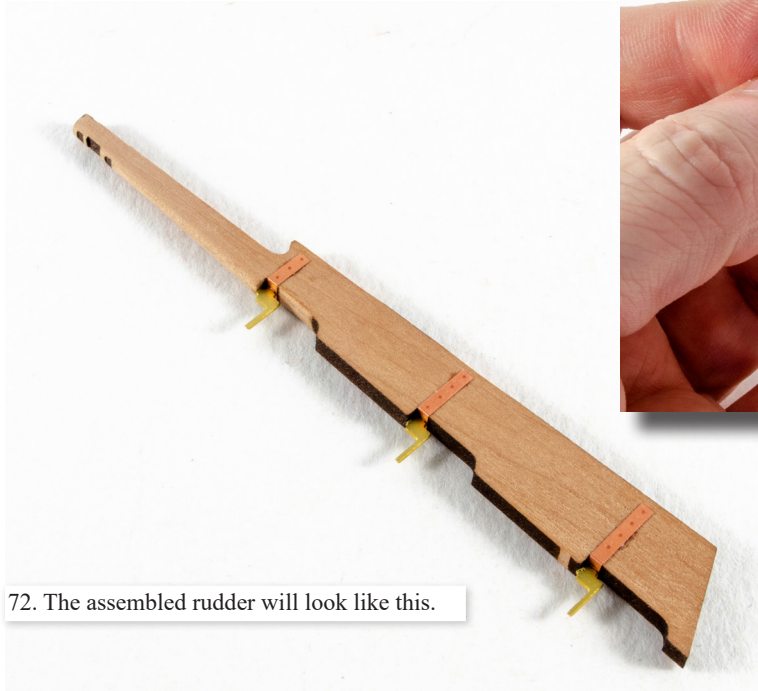

72. The assembled rudder will look like this.



74. Cut two strips of the supplied Black Cartridge Paper F-38 (approx. 1.5mm wide) and glue to the rudder, in the positions shown.



75. Take the two Till Arm parts 75 and glue them together. When dry, sand the Tiller Arm to round the edges and then drill then end of it to insert a cut-off brass pin that will be used to pin it to the rudder. Do NOT glue the tiller arm to the rudder yet.

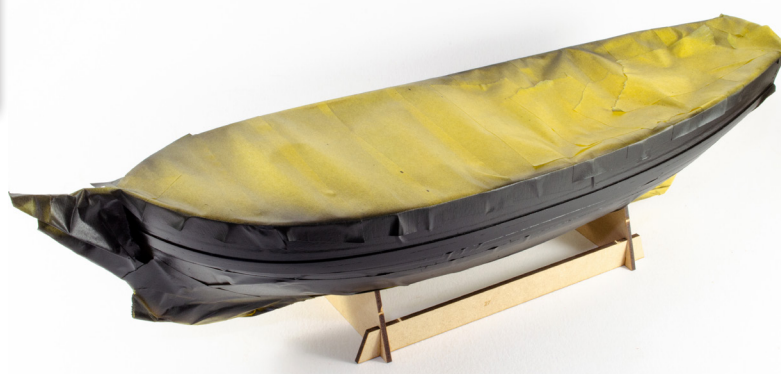
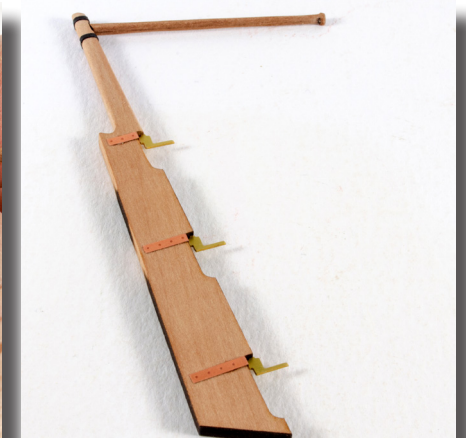

76. We will now paint the wales. You can do this in any manner you wish, but for the prototype, the whole model was masked off except for the wales, and 'Plastikote' Black was sprayed over that area in thin coats until a solid colour was achieved.

Main wale painted and masking removed



79. Sit your hull on its temporary cradle so the hull properly sits in the channels and use a waterline tool to mark the waterline. Check the height of this from the plans. I used the Amati waterline tool for this.



77. After gluing the Stern/Rudder post into position and leaving to dry, mark and drill it so the rudder can be fitted to it. Use a 0.8mm drill for this and check the fit of the rudder. Do NOT glue the rudder in place yet.



78. Run a strip of 3mm x 1mm F-34 wood along the bottom of the keel and use the MDF pegs to hold it in position. Leave the strip overhanging the keel far enough to cover the small gap between the keel and bottom of the rudder.

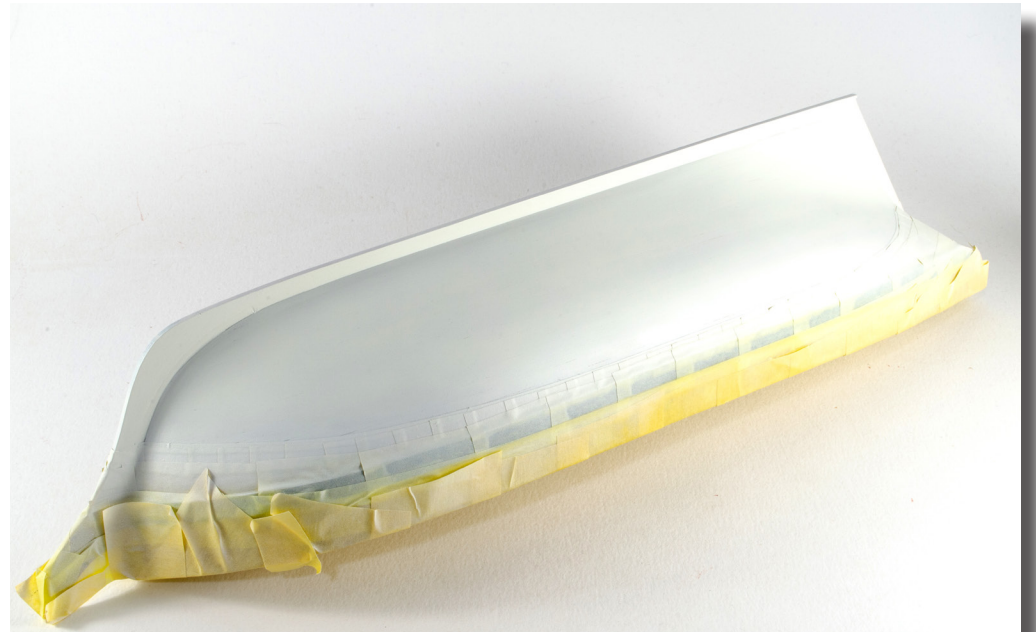

80. Mask the whole model above the waterline and spray the underside of the hull in white. If you encounter any gaps, then sand back those areas and fill with acrylic filler, before sanding and repainting.

Hull below waterline painted and masking removed. Take care when handling the hull at this stage to avoid marking the paintwork.

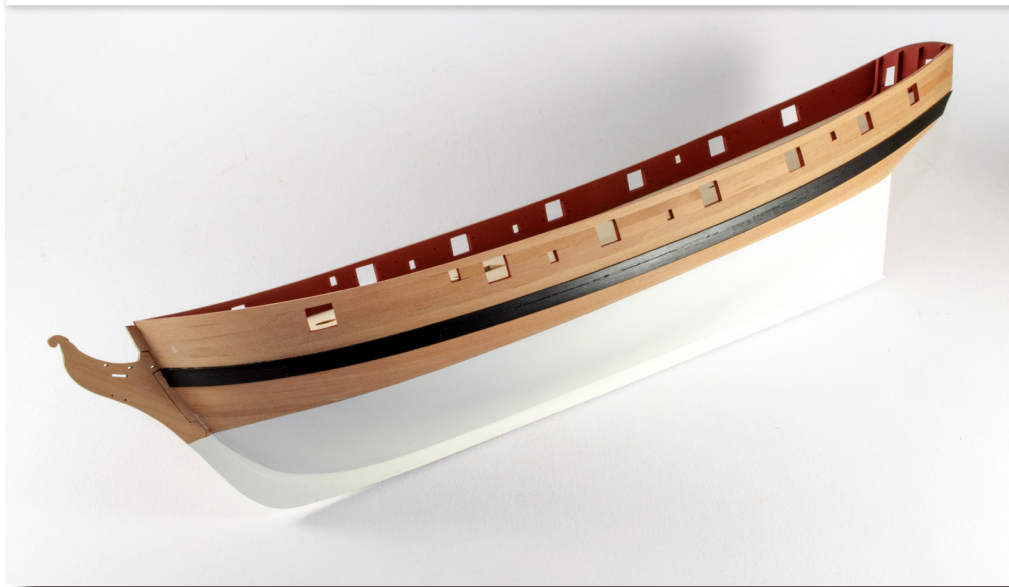

82. Cut the four Bow Upper and Lower Cheeks (99) from the 1.5mm wood sheet and glue into position as shown. You will need to bevel the edge that is in contact with the wales. Scrape away the black paint from the wales in those areas and glue the cheeks into position.



81. Glue the two Hair Brackets (45L & 45R) from the 1mm wood sheet into position so they contact the wales as seen in this photo. You may need to trim the ends of them to match it perfectly.



83. Take the two Anchor Hawse Bolster parts (79) and paint them black. Glue to the top of the wale, up against the prow, as shown here.



84. Mark the position for what would be the centre of a hole filling the semi-circle on the Anchor Hawse Bolsters and drill a 1mm pilot hole. Gradually open up the holes until they are 3mm. You may wish to place some scrap wood against the inside bulwark to stop the timber from splintering.



85. Cut both sets of Forward and Aft Gunwales (59 & 59a) from the 1mm wood sheet and drill a series of 0.6mm holes around them, a few centimetres apart. Check with the plan to make sure these holes are not over where the gun ports will be.

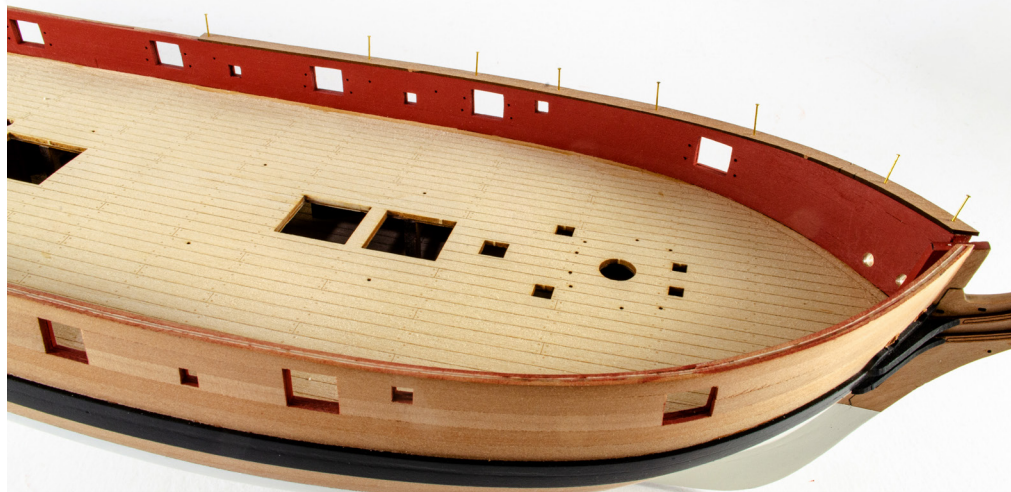

Lie the Gunwales along the top of the bulwarks and mark/drill a hole in the top of the bulwark, through the Gunwale holes. Check alignment with brass pins. Paint the Gunwale parts black and glue to the bulwarks. Temporarily use pins to secure it and either remove them fully afterwards or cut off the heads and push them down into the Gunwales to hide them.



86. Remove a section of the Aft Gunwale as seen here, approximately 3mm from the stern.



87. Take the two Stern Side Counter Timbers (57) from the 1mm wood sheet and glue them into position as shown. You will need to remove a portion of the rear wale to do this. The curve of the Stern Side Counter Timber should be flush with the stern underside curve. Paint the Stern Side Counter Timbers black.

88. Remove two sets of the Upper rail and swivel gun post timbers (40, 41, 42, 43, 44) from the 0.8mm ply sheet and lightly sand their surfaces. One set of these for port, the other for starboard. After sanding, paint/spray the parts black.

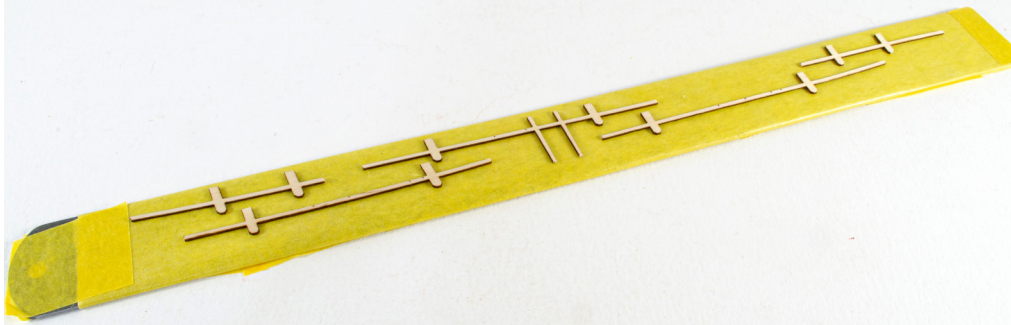

Before we fit these using the illustration for reference, sit them temporarily in position and use a pencil to mark the inside upper edge. This is the line we will use for painting demarcation. Seal the timber in that area with varnish, as we don't want the blue paint to soak into the wood. When dry, mask the area below the line and paint the upper area blue. Humbrol 25 Blue was used for the prototype. Glue the Upper rail and swivel gun post timbers in place using CA gel, and snip/trim the sections which run across the gun and oar ports.



You can also fit the Rudder Gudgeon and Pintle Braces PE-11, PE-12, and PE-13 from the 0.2mm PE sheet, and paint them. The lower ones will be white and the upper set in black (to match the rudder).



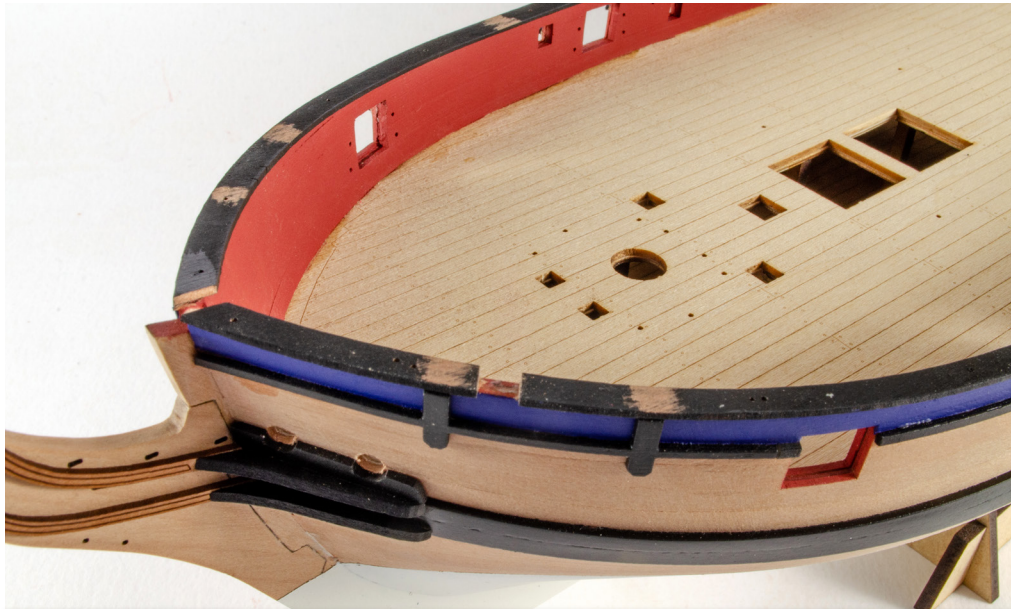

89. In the forward gunwale area, you will note some laser cut lines. These indicate a section to cut away for the catheads. When done, scrape away the gunwale paint at the top of the vertical timber on each Upper rail and swivel gun post position.



91. Cut the Swivel Gun Post Support Timbers (40a/b, 41a/b, 42a/b/c, 43a/b, 44a/b) from the 0.8mm ply sheet and paint them yellow before gluing in position as shown in this photo and the illustration. These are specific to their location, so don't mix them up. Now glue the Half-Pounder Gun Bases #103 into position on the gunwale, above the Upper rail and swivel gun post patterns.



90. Cut two Cathead timbers (139) from the 4mm wood sheet. Also remove two Cathead Cleats (PE-35) from the 0.6mm brass sheet. Glue these into the Catheads, check the plan for orientation. Paint the Catheads in black and add the Cathead End Cap Decoration PE-6 after painting them yellow. We used Humbrol 74.



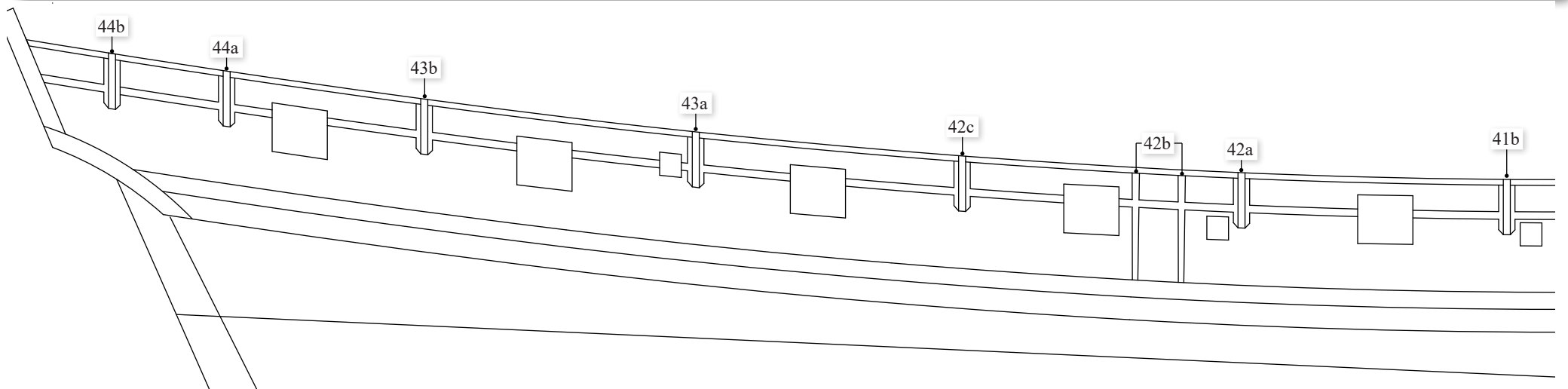
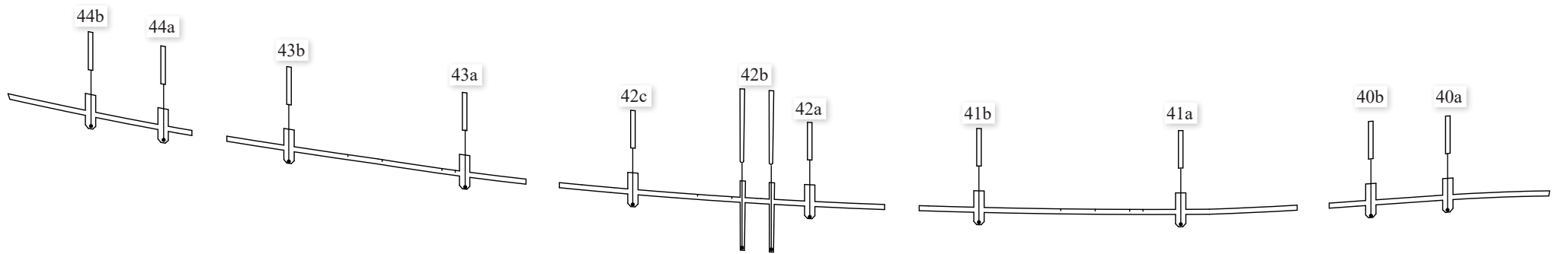
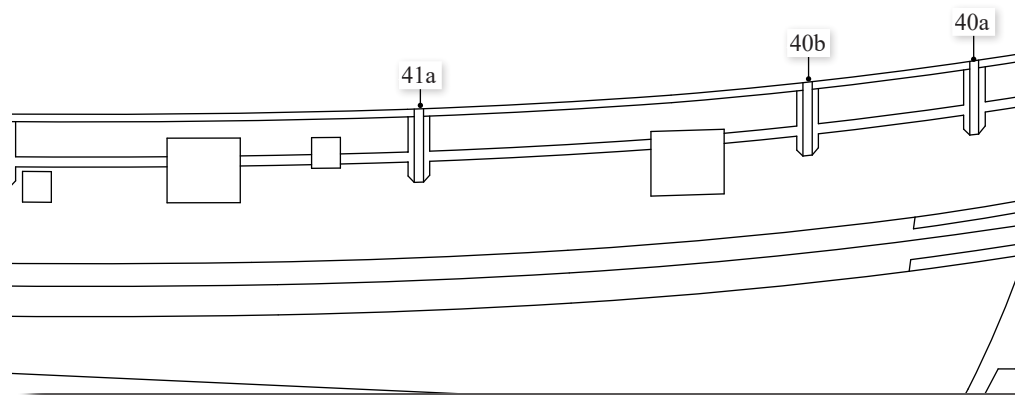

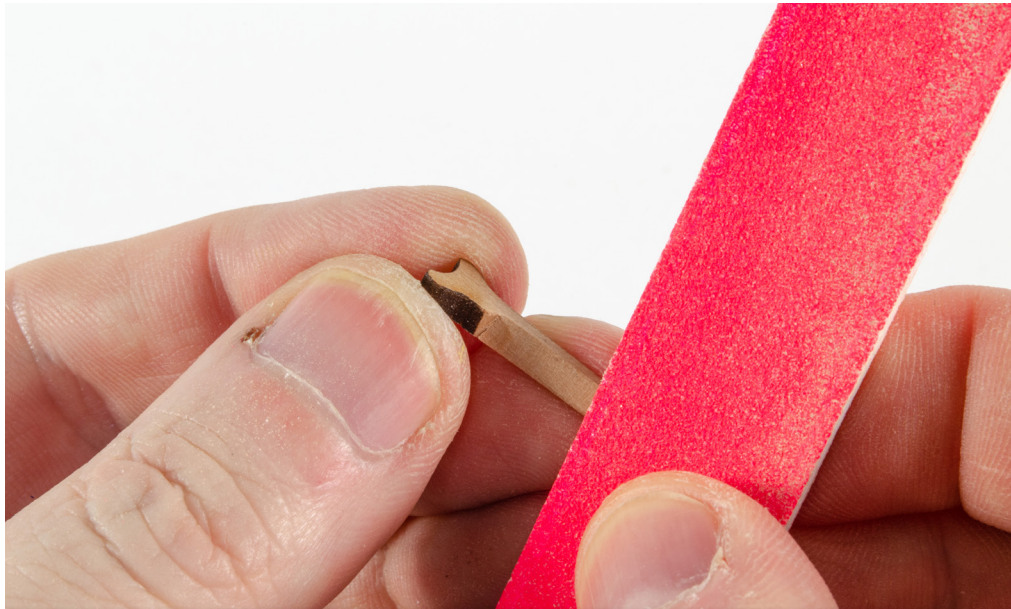

92. Remove the two Boom Crutch parts 128 from the 3mm wood sheet and bevel them as shown here.

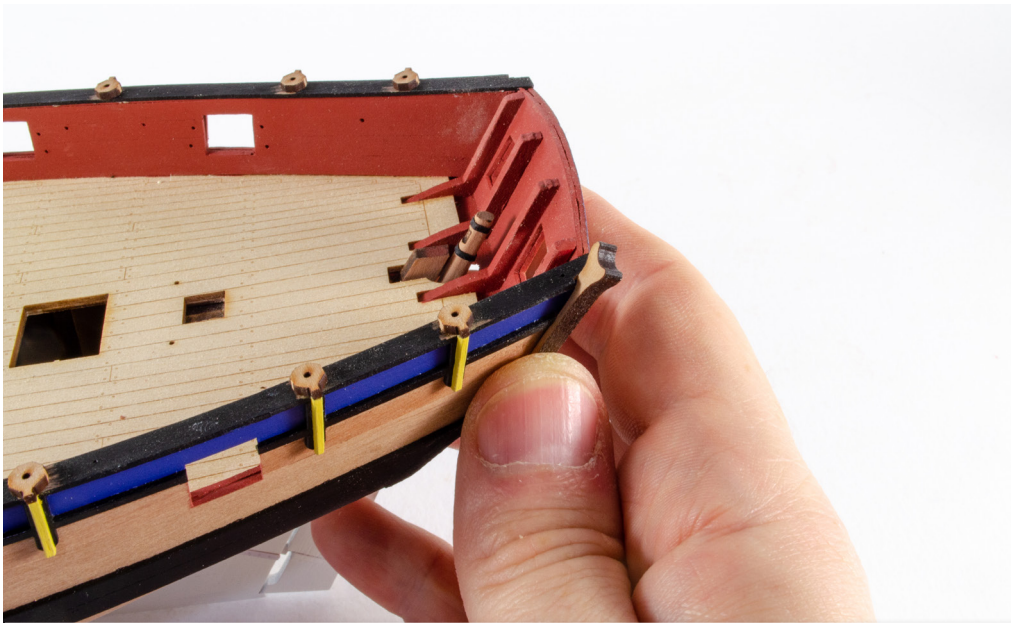

When fitted to the hull, they should be flush with the stern board. Refer to the plan images also. Also trim the Upper rail and swivel gun post pattern as you did with the gunwale, so the crutch can be fitted.

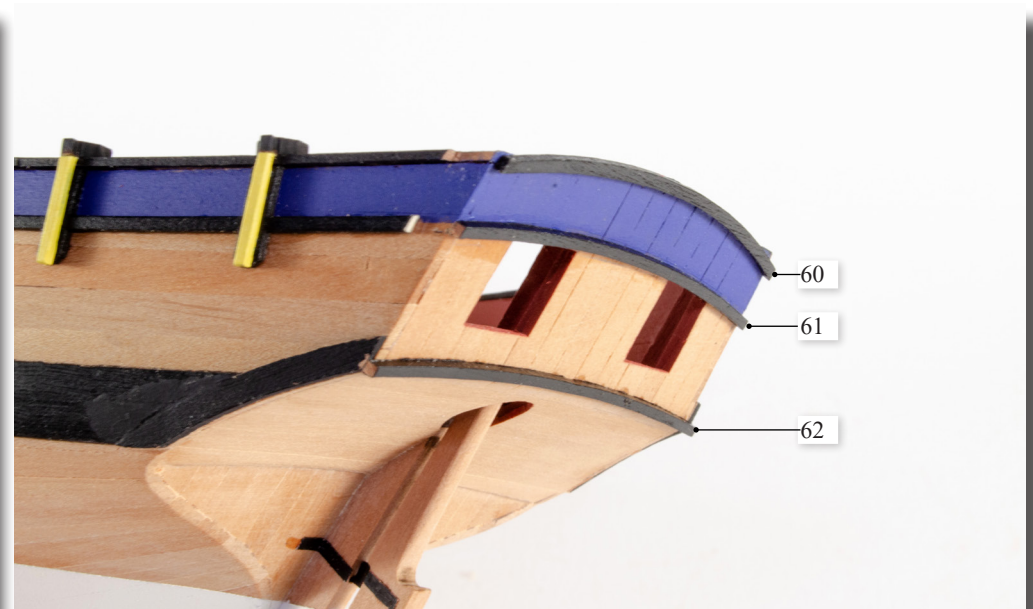

Apply the Stern Board Rails, parts 60, 61, and 62 to the stern board, after painting black. You may wish to paint the upper area in blue to match the upper bulwarks, but this isn't mandatory. Trim the edges of the rails so they don't protrude past the edges of the Stern Board.



93. Glue the Boom Crutch parts into place at the stern, as shown. Add a length of 1mm x 4mm planking strip to the top edge of the stern board for the capping rail, and paint black.



94. Fit the Catheads into place at the bow and paint the swivel gun mounts in black to match the gun-wale.

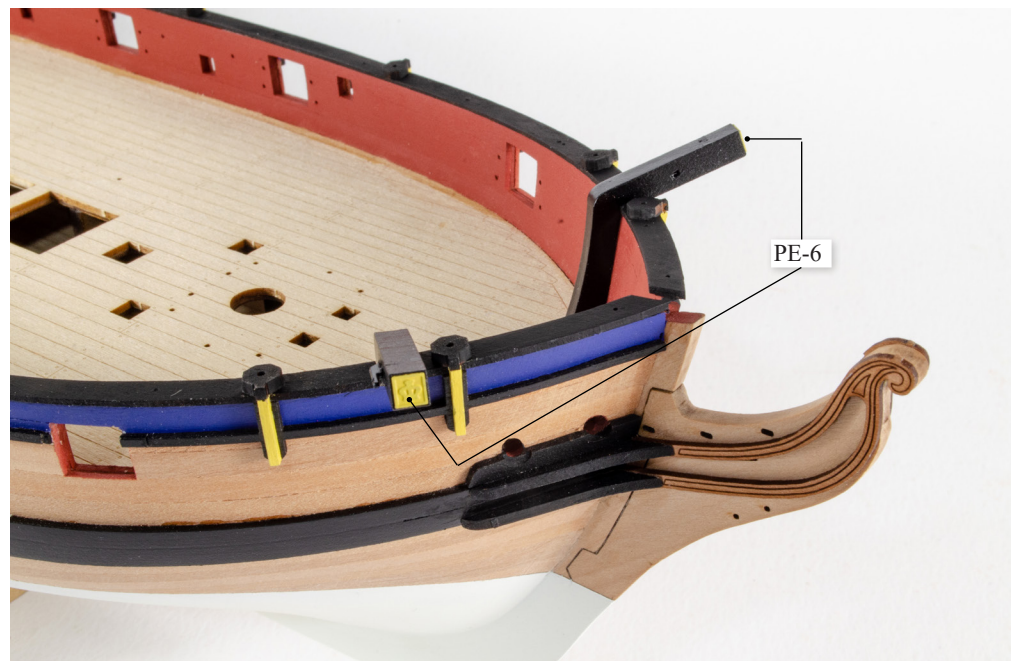

95. Remove the Bow 'V' shaped vertical rail parts (PE-37, PE-38, PE-39) from the 0.6mm PE sheet and paint the inner area in black. When dry, paint the outer area in yellow.

Slot these through the slots in the Stem Pattern (short one at front and long one at back), with the black décor on the underside. Bend these upwards slightly at the fold marks.

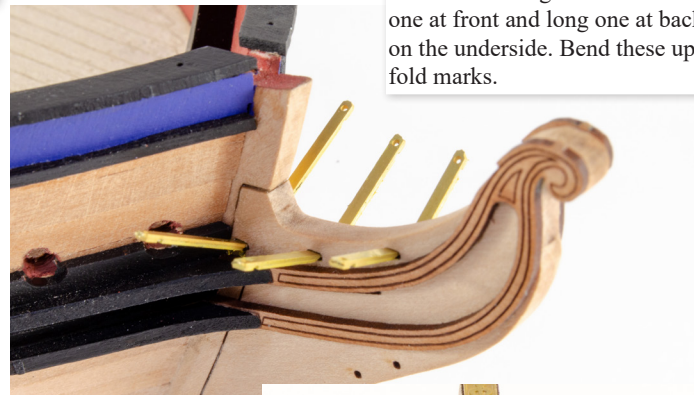

Now fit the two Bow Main Rail parts, 46. Fit these as shown and bend the PE parts so they are in contact with the rails. Add a spot of glue. You can also now add the two Cathead Knees 98, between the cathead and bow main rails.

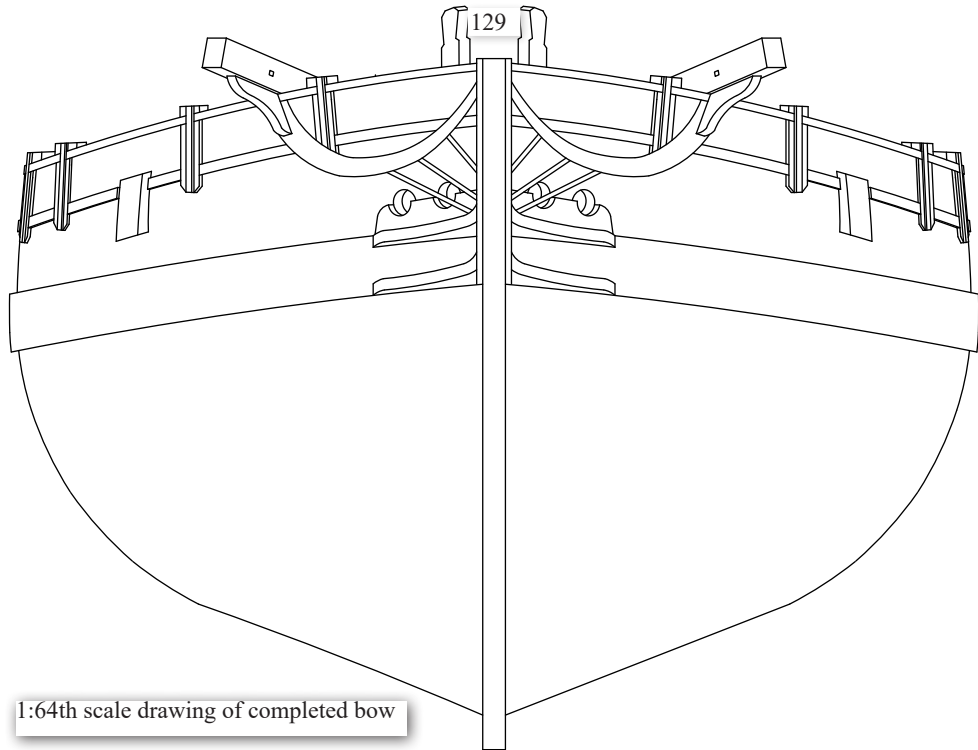
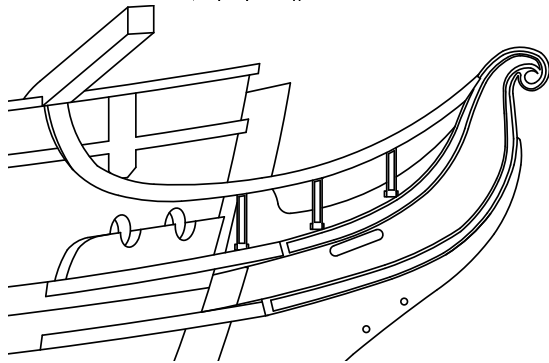
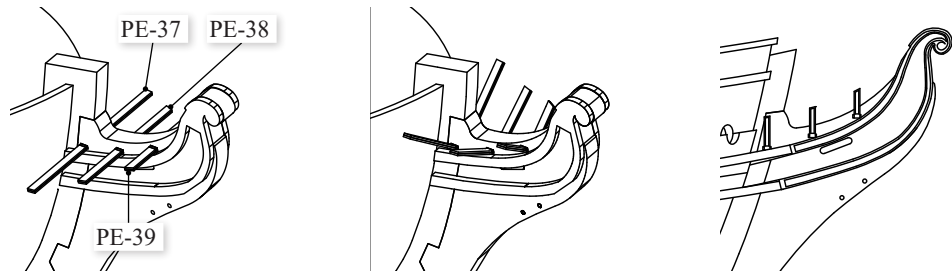

1:64th scale drawing of completed bow

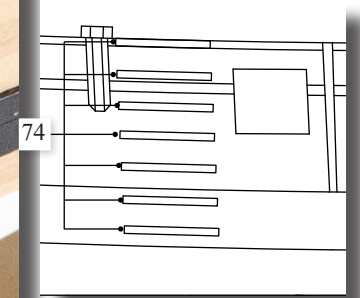

96. Fit the Side Step parts 74 to the hull sides from the 1mm wood sheet. Mark out the positions using the full-size drawing and glue each step into place. To ensure vertical alignment, apply a length of masking tape down the hull and glue each step so the ends touch the edge of the tape. Paint the steps on the main wale black, and the also the step located on the edge of the gunwale. Paint the step in the upper bulwark in blue.

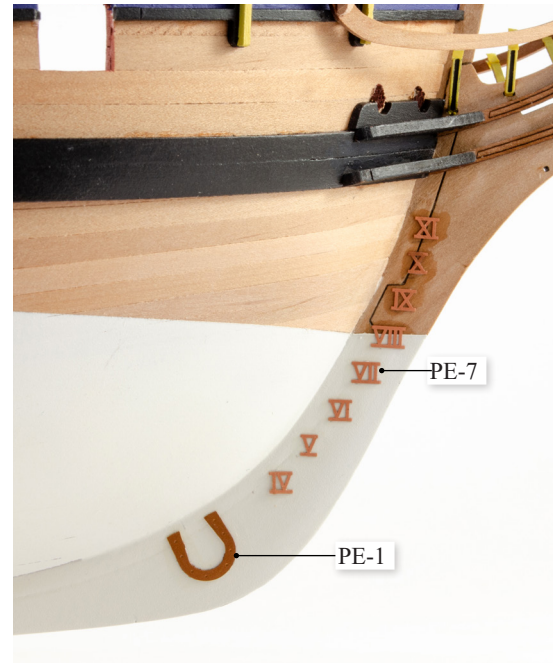

97. Paint copper and fit the Horseshoe Plate (PE-1), Fishplate (PE-2) and the Depth Markings (PE-7) to the hull as shown. For the prototype, CA gel was used.

Inner bulwark detail

98. Cut eight of the Deck/Bulwark Cleats (87) from the 1.5mm wood sheet and drill a 0.8mm hole through the middle of them from the front. Insert a brass pin into them with glue and then paint the cleats in black. Snip the pin so it's about 2mm long.



99. Remove the Belaying Pin Racks 95 & 96 from the 1.5mm wood sheet and paint them the same red as the inner bulwarks. Cut a brass pin in half and insert the sharp end into a 0.8mm hole so the sharp edge sticks outwards.

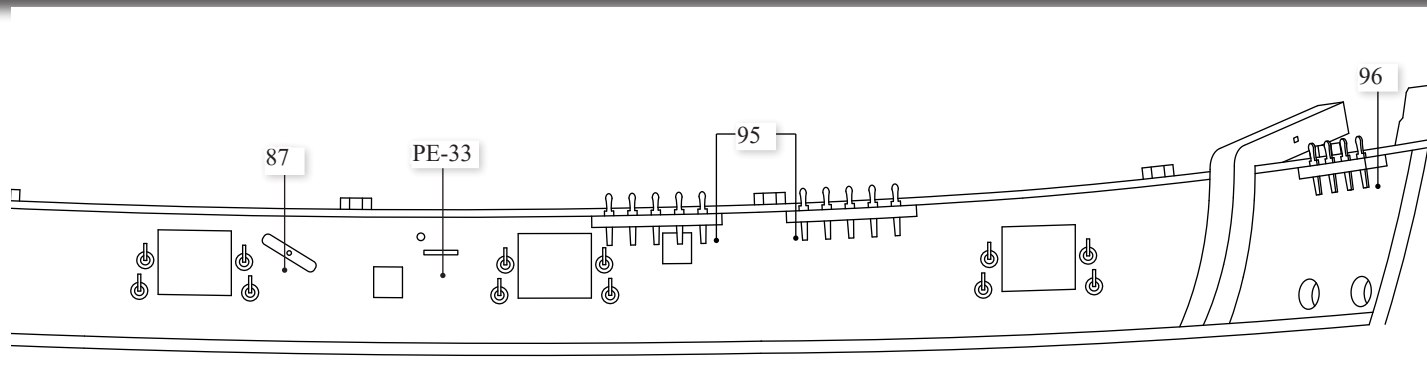
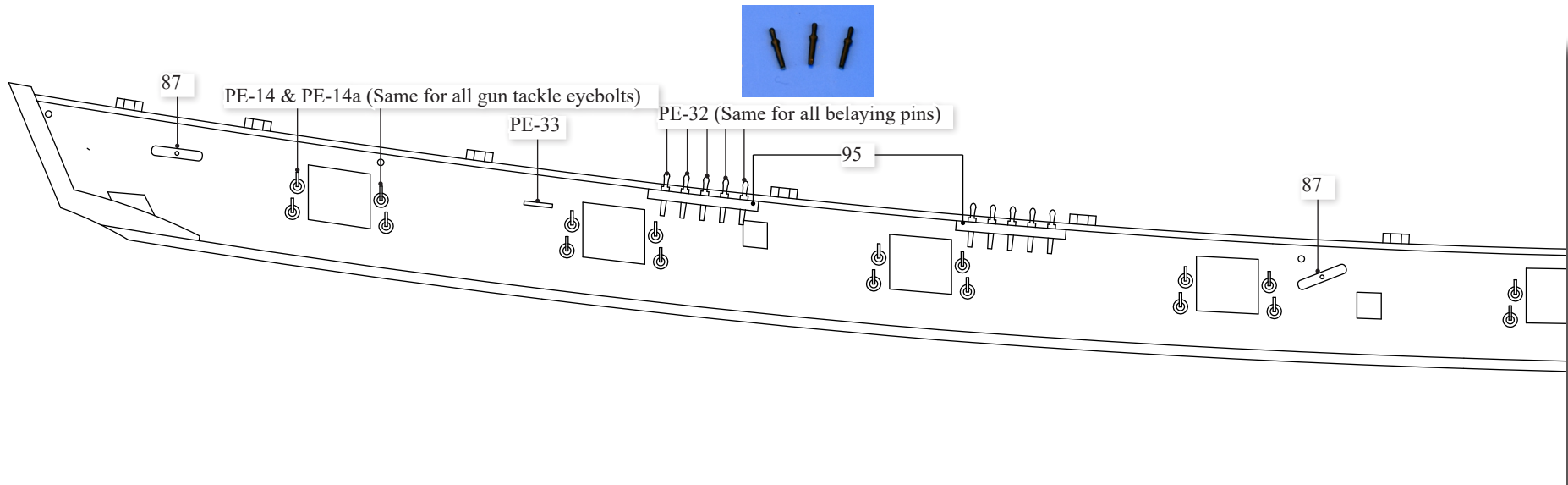
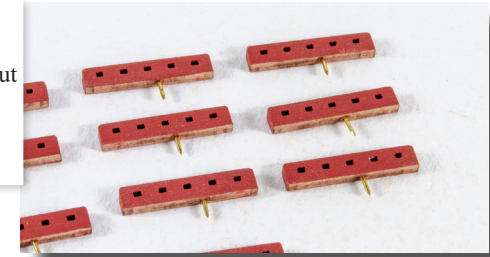

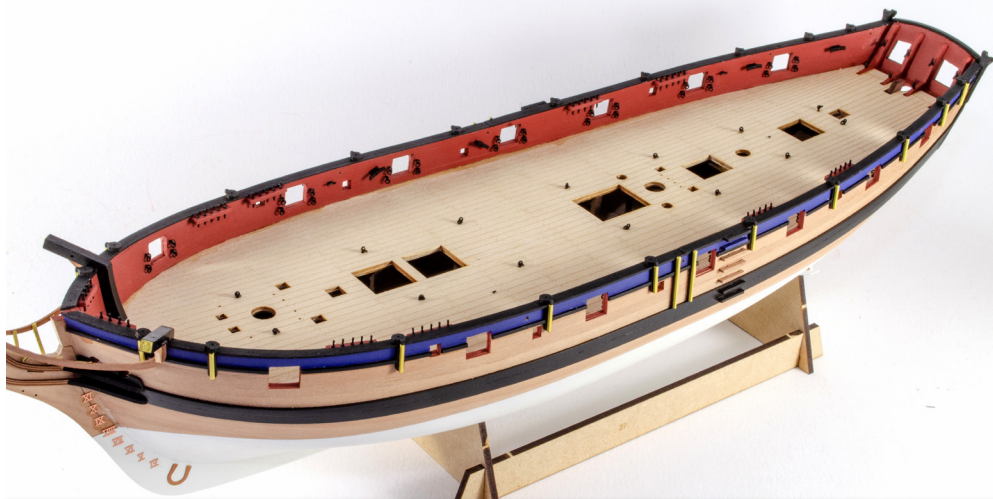

100. Glue the Belaying Pin Racks into position around the inner bulwarks, using the plans as reference. You may need to drill a 0.8mm hole at the point where the rack pins touch the bulwark. Also scrape away any paint from the contact surfaces first. When dry, glue the Belaying Pins PE-32 into the holes in the belaying pin racks, and then paint the pins black.

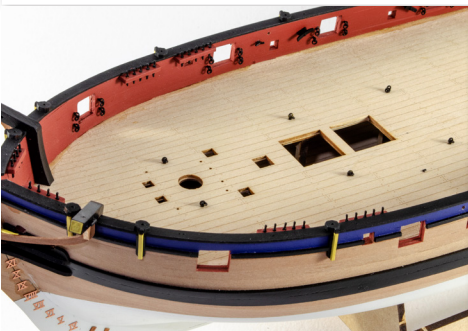

101. Fit the Open Eyebolts (PE-14) and Eyebolt Rings (PE-14a) (once assembled and painted black) to the holes next to the gun ports and also to the correct positions on deck (check plan for positions). Also fit the Small Cleats PE-33 to the correct positions on the inner bulwark and also to the inner stern timbers. Paint black. Fit the Closed Eyebolts PE-15 to the inner stern timbers too, using plan as reference. Paint black. Before these PE parts are fitted, you will need to drill a 0.8mm hole to accommodate them.

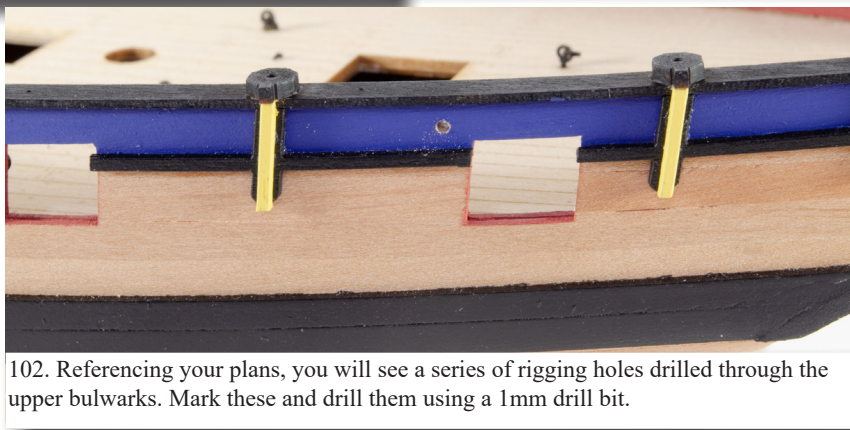

102. Referencing your plans, you will see a series of rigging holes drilled through the upper bulwarks. Mark these and drill them using a 1mm drill bit.

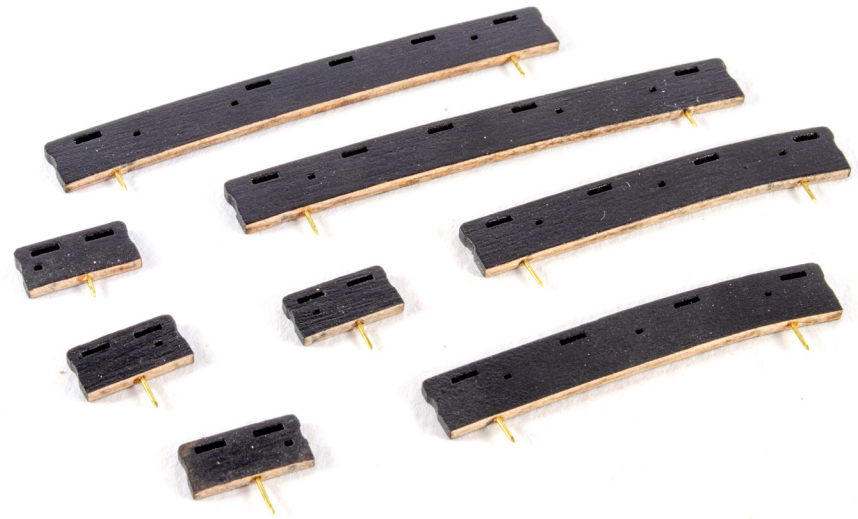

103. Remove all Channel parts (100, 101 & 102) from the 1.5mm wood sheet and paint them black. Drill the connecting faces and add some cut-down brass pins to help strengthen the connection to the hull. Using the plans as reference, position and glue the channels. You will need to drill some 0.8mm holes to accept the pins. We also prefer to use wood glue for the channels as it's not as brittle as CA when under stress.



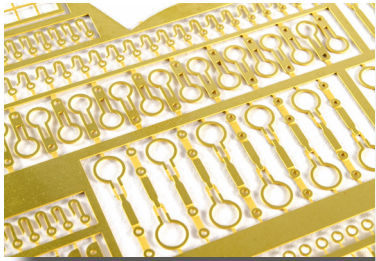

104. Identify all the 3mm and 5mm Deadeye Stropps (PE-18, PE-19) on the 0.4mm brass sheet and paint them black.

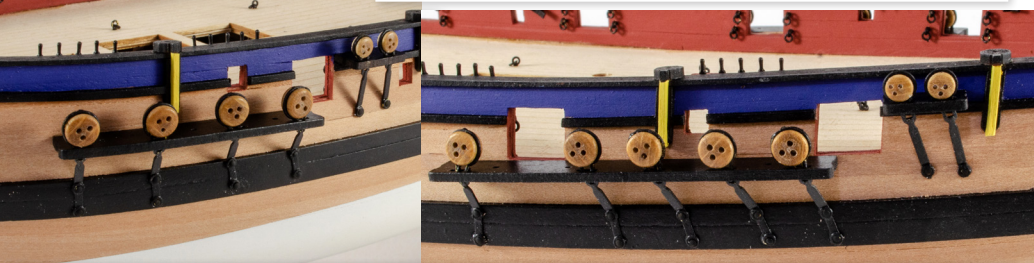

Remove them from the sheet and use a pair of tweezers/pliers to open the up the ring. Take the deadeyes F-7 and F-8, and insert them in the stropps, use the tweezers/pliers to close up the ring and trap the deadeye. Use black paint to touch up where any has been damaged.

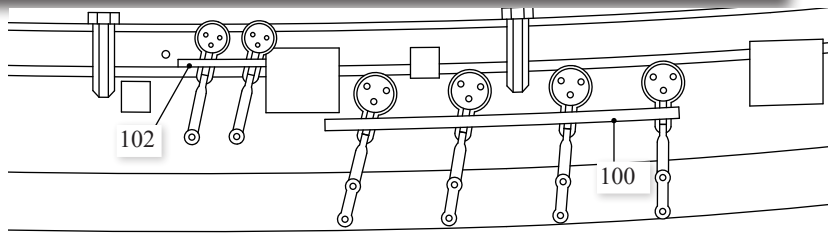
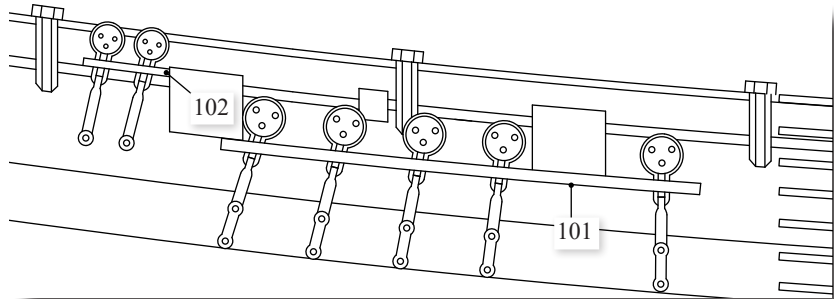

105. Sit the deadeye stropp though the slots in the channels and pin/glue the stropps to the wales, using the plan for reference of angle for each chainplate assembly.

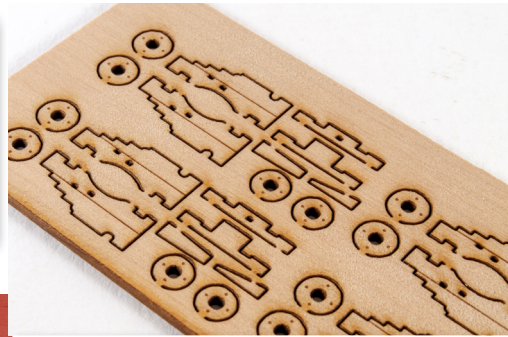

106. Cannon: Remove all parts for the cannon carriages (PE-106, 107, 108, 109, 110, 111, 112) from the 1.5mm wood sheet and set aside in separate pots. Use a fine piece of sandpaper to round off the wheel axles and test the fit using a wheel. Assemble all cannon carriages, minus wheels.

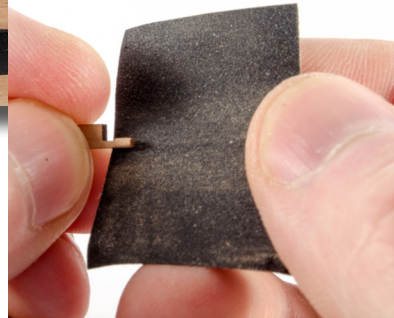

106. Cannon: Remove all parts for the cannon carriages (PE-106, 107, 108, 109, 110, 111, 112) from the 1.5mm wood sheet and set aside in separate pots. Use a fine piece of sandpaper to round off the wheel axles and test the fit using a wheel. Assemble all cannon carriages, minus wheels.



107. Spray the cannon carriages in the same red paint used on the inner bulwarks.

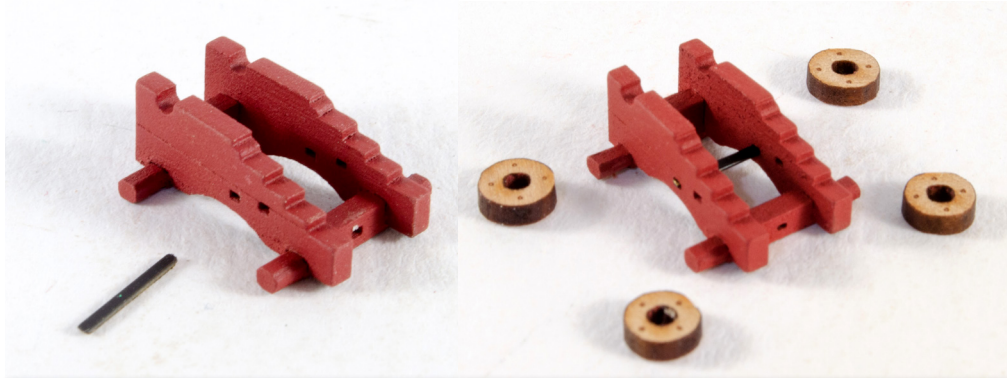

Glue the 4-Pounder carriage 'Traverse Bolts' PE-22 between the forward slots in the gun carriage sides, and then glue the wheels in place. Note that the larger wheels go at the front. If you leave the dark edges on these, place the connection/cut point at the bottom when on the carriage.



Glue the 4-Pounder carriage Bed (PE-110) into place on top of the rear axle, butting up against the traverse bolt. Now glue the cannon into position, noting that the little emblem is on the upper side. Finally, paint the 4-Pounder carriage cap square (PE-3) and Closed Eyebolts (PE-8) and glue these onto each carriage. NOTE: A 4-Pounder carriage quoin (111) is also supplied for historical accuracy, but you shouldn't need to fit these to the carriages. You could display them alongside.



108. Finished cannon

General views of a typical cannon breech rope and training tackle

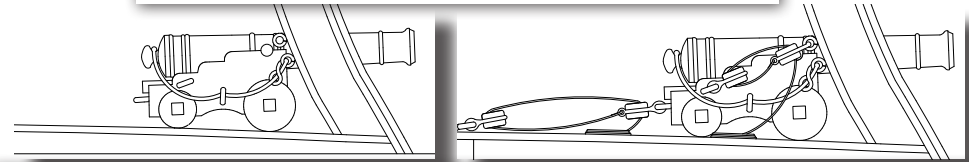

Optional - Above left - Rigging the cannon with breech rope only. Above right - Rigging the cannon with breech rope and training tackle. The blocks are all 2mm single blocks (included in kit), and the rope would be 0.1mm, with the breech rope being 0.75 natural.

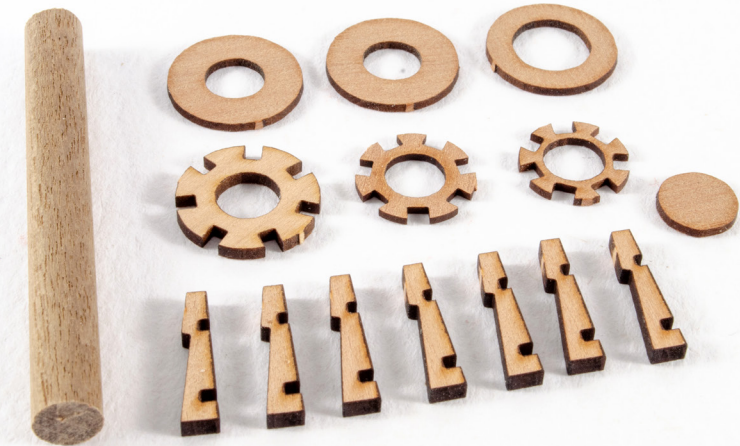

109. Capstan: Cut all the required parts from the wood sheets (47, 48, 70, 71, 93, 115) and cut a length of 6mm dowel, 50mm long. Glue the Whelps (115) around the edges of the Capstan Upper/Lower Chocks (47 and 48), creating a drum. Glue the Capstan Bar Ring (93) to a Capstan Ring (71). On the other side of the Bar Ring, glue the Capstan Top (70). Do NOT throw away the centre disc from this. Insert the dowel into the capstan and use this to position and glue the other Capstan Ring (71) to the bottom of the capstan.



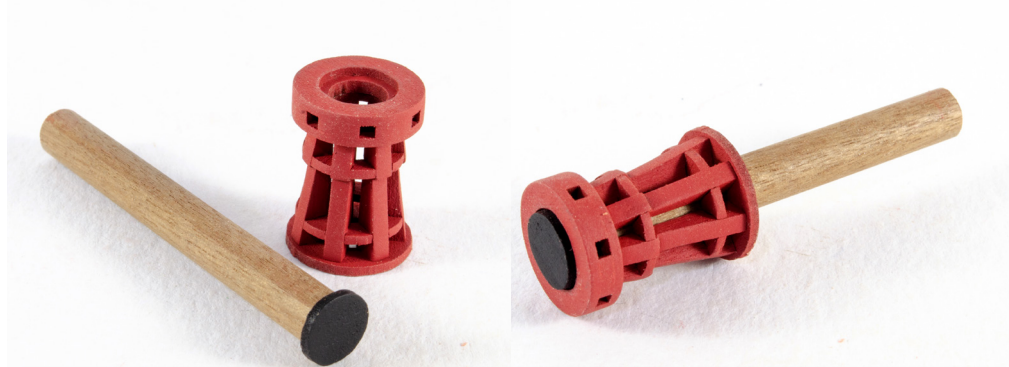

110. Push the dowel through the capstan until you see the end in the top, and then glue the small disc from '70' into the hole, but only onto the dowel. When set, remove the dowel/disc and paint the disc black. Paint the rest of the capstan in the bulwark red paint.

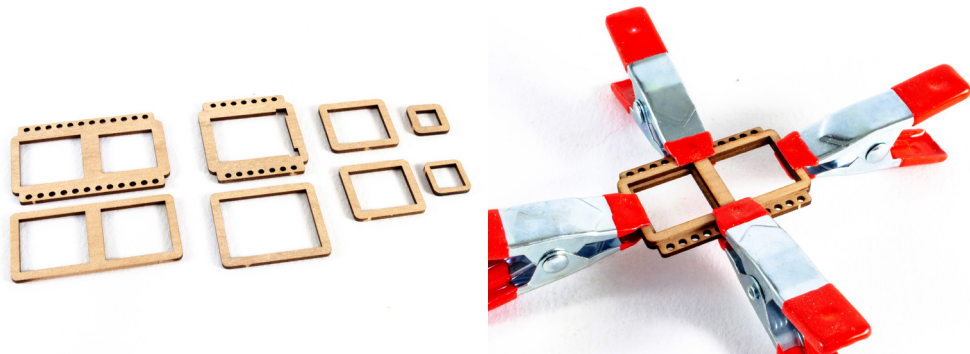

111. Hatches and Combing: Remove parts 91 & 91a, 90 x 2, 88 & 88a, and 89 & 89A, from the 1.5mm wood sheet. Glue the corresponding pairs on top of each other to create the combings. Using clamps is a good idea whilst they dry. Paint the assemblies in bulwark red. Alternatively, you could leave the combings unpainted and simply varnish them with a clear matt varnish.

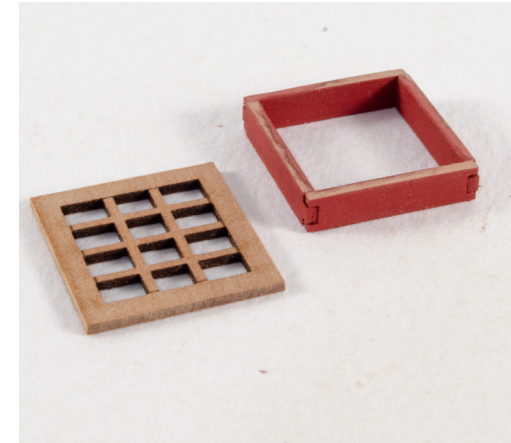
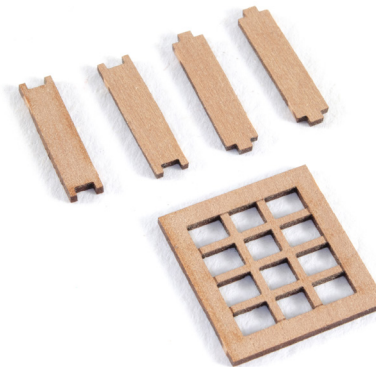
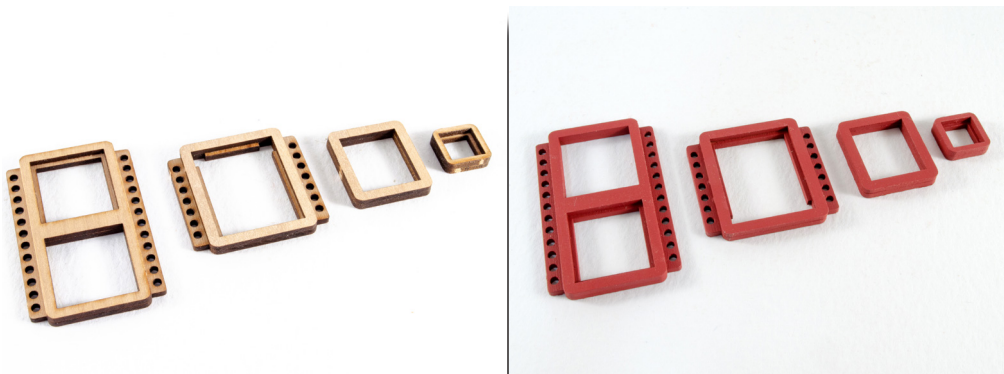

112. Skylight: Remove parts 64, 80, and 81 from the 1mm wood sheet. Take the Aft Skylight Combing parts (female and male) and build the combing. Set aside to dry and paint bulwark red or leave natural and paint with clear matt varnish. Leave the Skylight Frame (64) in natural wood and glue it to the top of the combing.

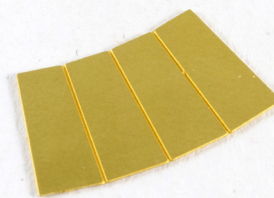

113. Stove Flue: Remove the Stove Flue PE-25 from the 0.4mm PE sheet and bend it to shape as shown. Paint it black.



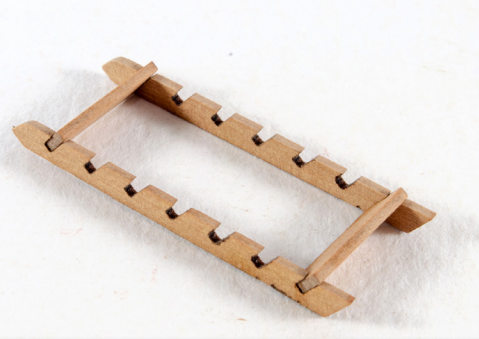
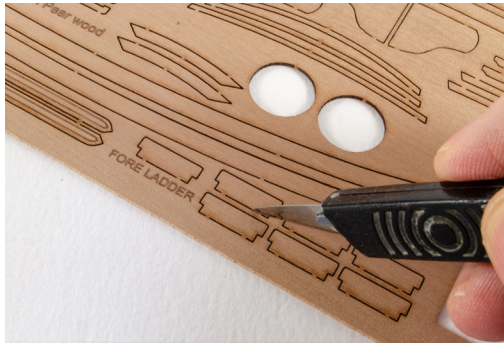

114. Ladders: Remove all parts for the Fore Ladder (67, 67L, 67R, 68) from the 1mm wood sheet. These parts are clearly identified on the sheet by the text 'FORE LADDER'. Glue the first and last steps between the two parts 67 and make sure everything is aligned before letting the glue set..



When set, glue all the other steps into position, and finish the ladders by gluing on the Outer Sides (67L & 67R). Now build the Aft Ladder in the same way, using the parts highlighted on the same 1mm wood sheet

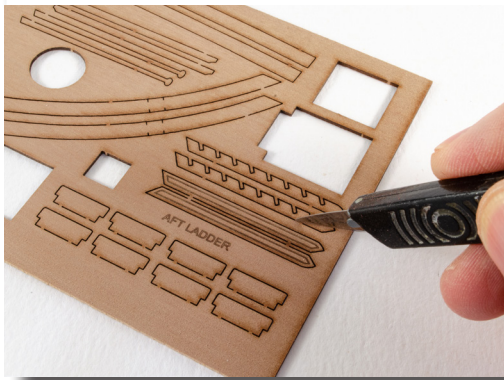

Repeat the procedure for the aft ladder assembly. Once both are assembled, they can be given a light coat of clear matt varnish

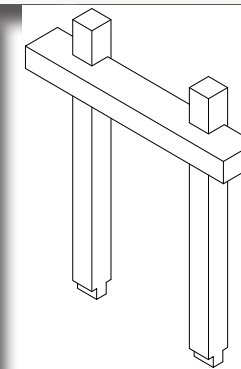
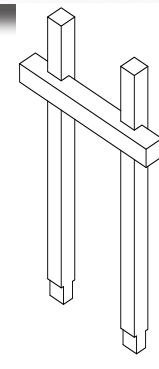
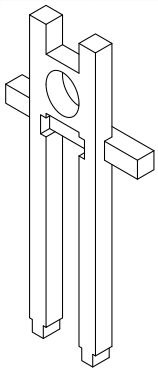

116. Bowsprit Post & Fore & Main Mast Bitts: On the 3mm wood sheet, take the Bowsprit Post (130) and glue it to the Bowsprit Post Cross beam (131). Take the Main Bitt Post Cross Beam No.133 (Front of mast) and glue it to the two Main Bitt Post (Front of mast), No.132. Lastly, from the 4mm wood sheet, cut out and assemble the Fore Bitt in the same way, with parts 137 and 138. When all bitts are dry, paint them black.

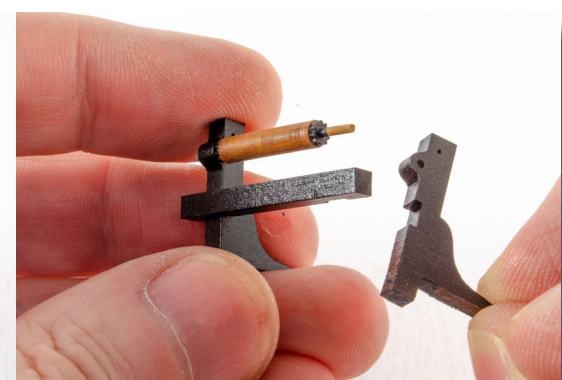

117. Main Bitt/Windlass: Cut parts 134 and 135 from the 3mm wood sheet and glue 135 to ONE of the 134 parts. Paint all wood parts in black. Now paint the Jeer and topsail bitts windlass F-1 in a wood colour with black ends, and slot this into the hole in the two assembled wooden parts. You may need to open up the hole if it's too tight. Now glue the other wooden part to this assembly.

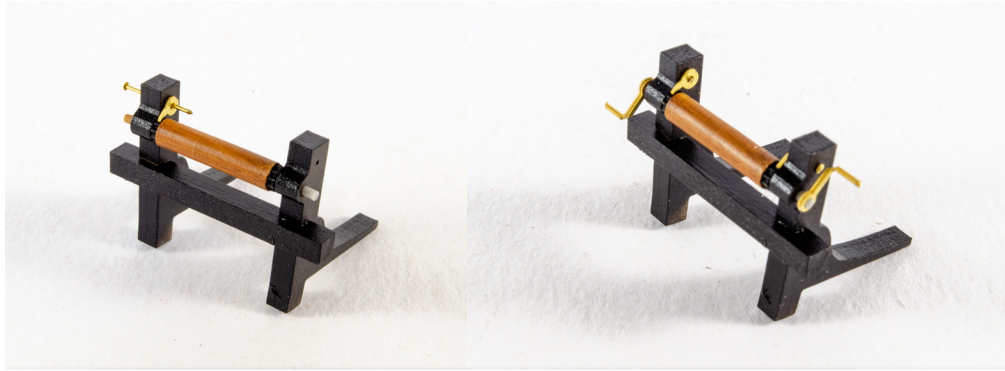

Using brass pins, locate and fit the Drum windlass Pawls to the windlass, with them resting on the gear at the ends of the drum. Glue in position and paint the metal parts black. Bend the two Winch drum turning handles PE-49 and glue into place as shown. Also paint black.

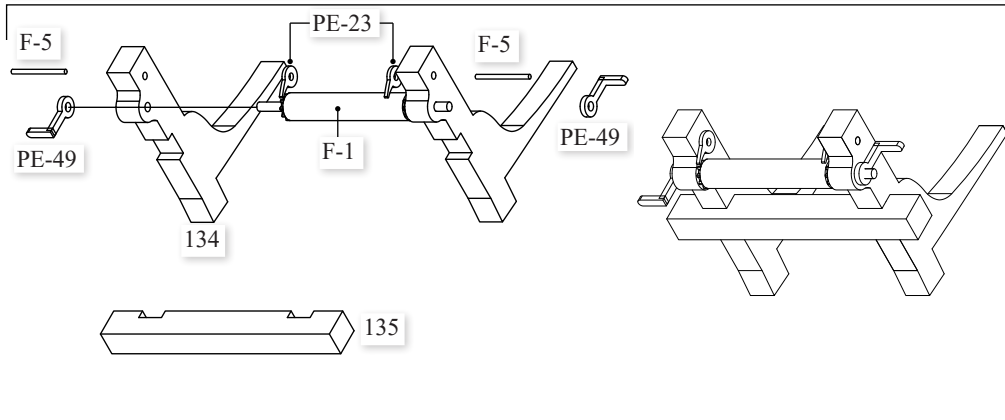

118. Deck Pumps: From the 0.4mm brass PE sheet, remove all parts PE26, PE-27, and PE-28. Also cut two lengths of 4mm dowel, 40mm long. Using brass pins, sandwich a Deck Pump Main Body PE-27 between two Deck Pump Main Body Side Frames PE-26. Use CA to glue and then snip the brass nails off.

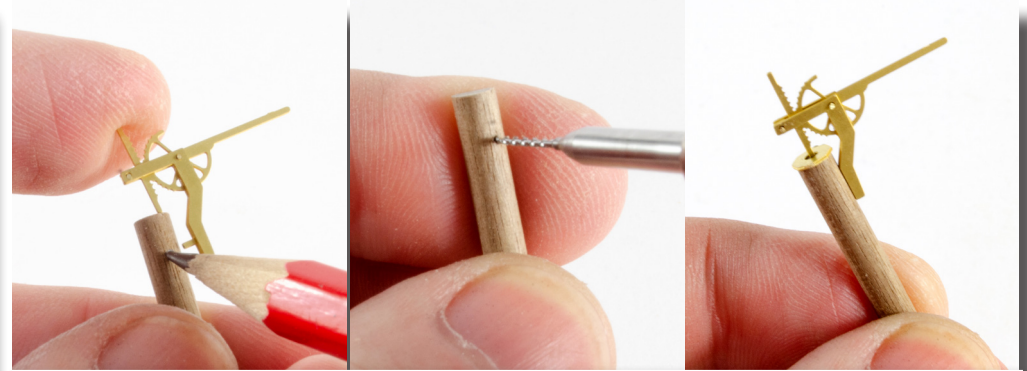

119. Sit the thin vertical length on top of the dowel and mark where the lower pip touches the dowel. At that point, drill a 0.8mm hole into the dowel. Glue the Deck pump Top Cap PE-28 to the top of the dowel and sit the pump head in position, with the pip pushed into the hole you drilled. Paint the metal parts black and built two pumps..

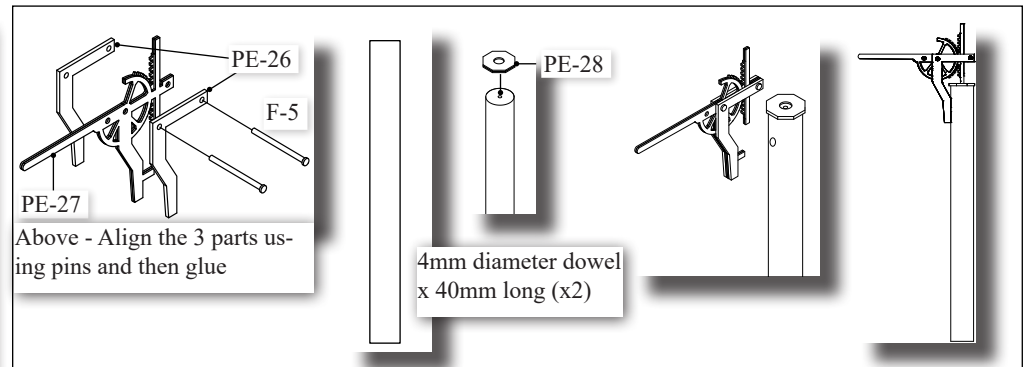

Above - Align the 3 parts using pins and then glue

4mm diameter dowel x 40mm long (x2)



120. Completed deck pumps. If you want to add more realism, use a metallic pigment to dry brush the painted parts.

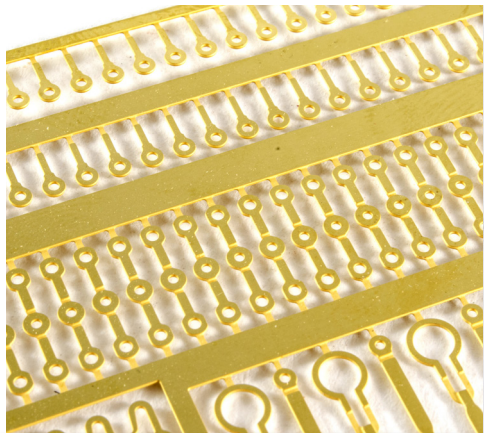

121. Swivel Guns: Locate and paint black the Half-Pounder swivel gun brackets PE-24. Also locate and paint the Half-Pounder swivel gun handles. Cut all the brackets and handles from the sheet.



122. Drill the rear of the resin Half-Pounder swivel gun barrels, using a 0.8mm drill, and glue the gun handles into position.



123. Bend the bracket into a U-shape at the fold lines and glue a brass pin into the middle hole. Now glue the gun barrel into position so it's horizontal to the bracket and cut the brass pin shorter.



124. Fitting out the deck: Glue the Bowsprit Post and Fore Bitt and glue them into position. These insert through the main deck and locate into holes in the lower deck. Now paint (black) and glue the Flue Combing (92) and Fore and Main Mast Bases (97) into position. Glue the Forward and Main Hatch Combing in position too. Note the orientation of the Main Hatch combing. Paint the 2mm Diameter cannon balls (F-4) black, or stain them, and use white glue to fox them into the shot garlands on either side of the combings.



125. Glue the Main Bitt into position. This slides through the corners of the Main Hatch combing and locates into holes in the lower deck. Also fit the Aft Ladderway Combing, Skylight, and Bread Room Hatch. You can also now glue the Gratings 62 & 63 into position. Do NOT glue the grating 61 at this stage.



126. Using the plans as reference, fit the fore and aft ladders.



127. The Main Bitt/Windlass can now be installed as shown here. Also glue the capstan into position. The black centre of this should protrude slightly.

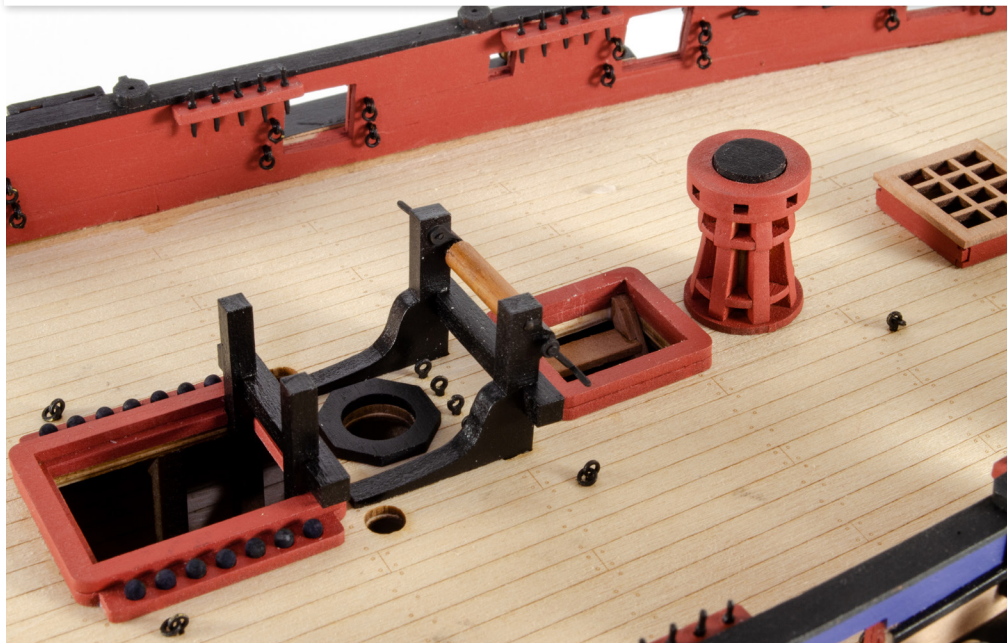

128. Using the plans for orientation, glue the deck pumps into position. These also locate into holes in the lower deck.

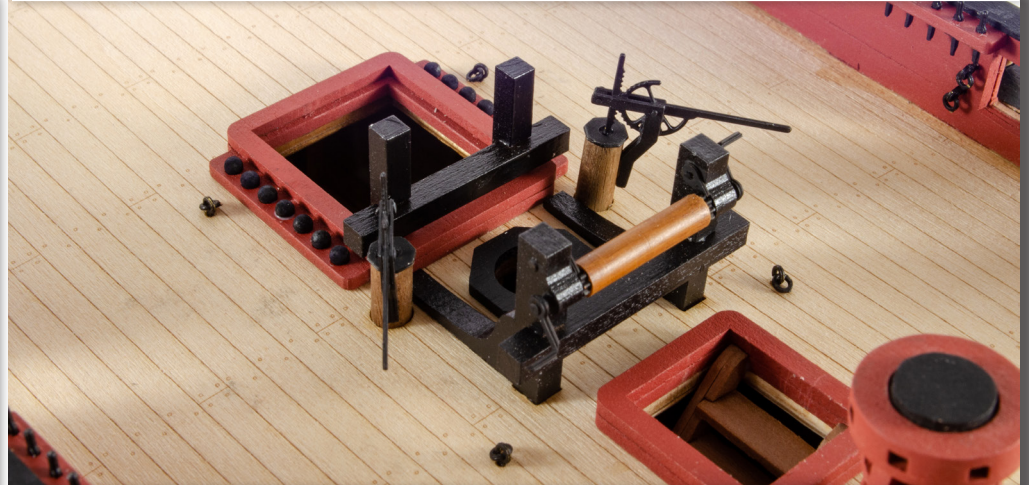

129. Now for the fun part. With a spot of glue on the underside of each wheel, glue the cannon into position, a millimetre or two away from the bulwarks. The gun cart should also be sat perpendicular to the bulwarks, and of course, centrally in the gun ports. Also glue the swivel guns into position. You can use any of the mounting points you wish. Although there are 20 points, Flirt never had more than 12 of these occupied with a gun. The guns were designed to be removable on their mounts so they would just plug into another position. When you select the position, use a 0.8mm drill and drill a few millimetres into the bulwark. Now glue the guns into position with CA.



Deck fittings and hatch combings general arrangement

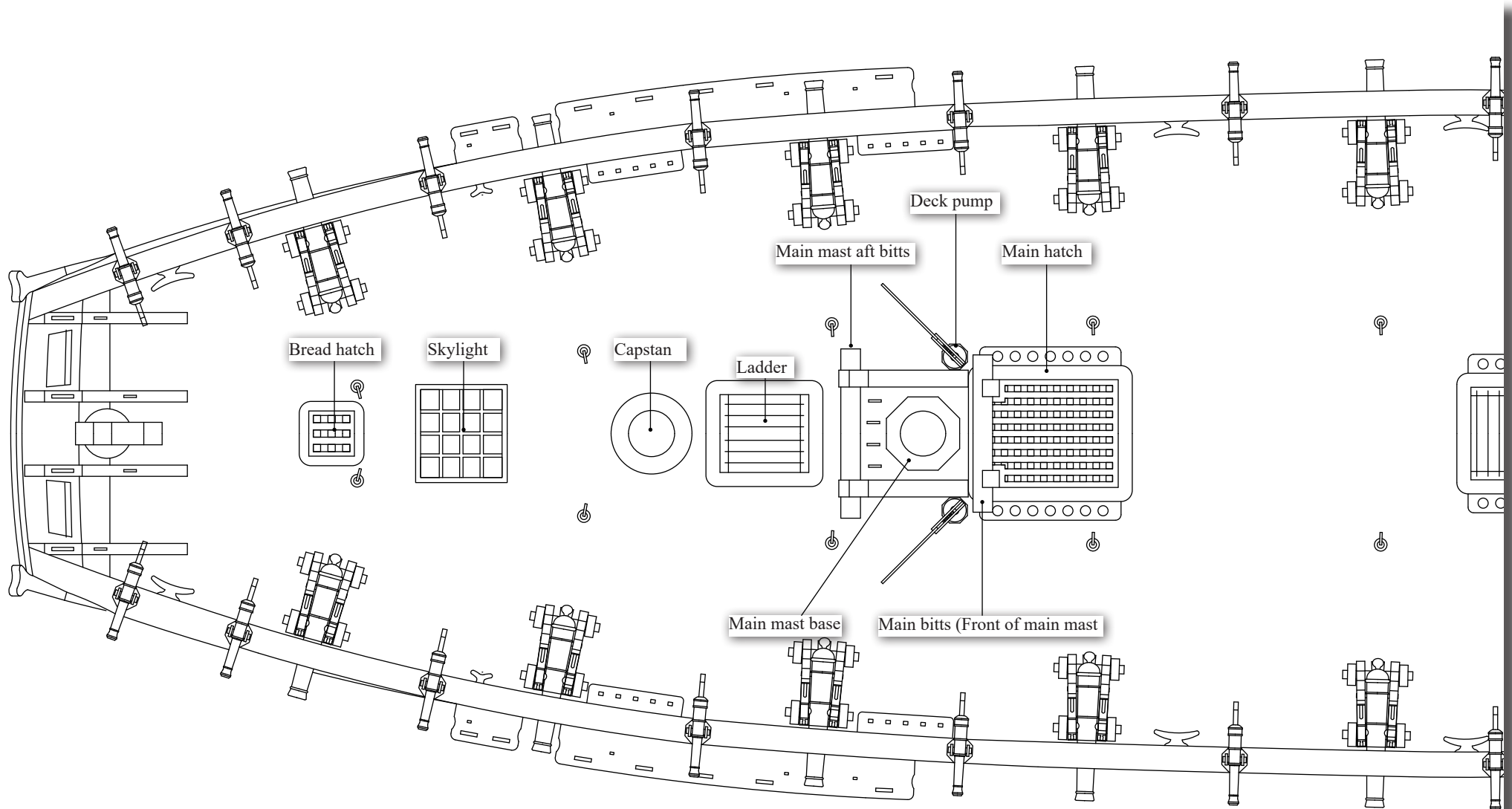

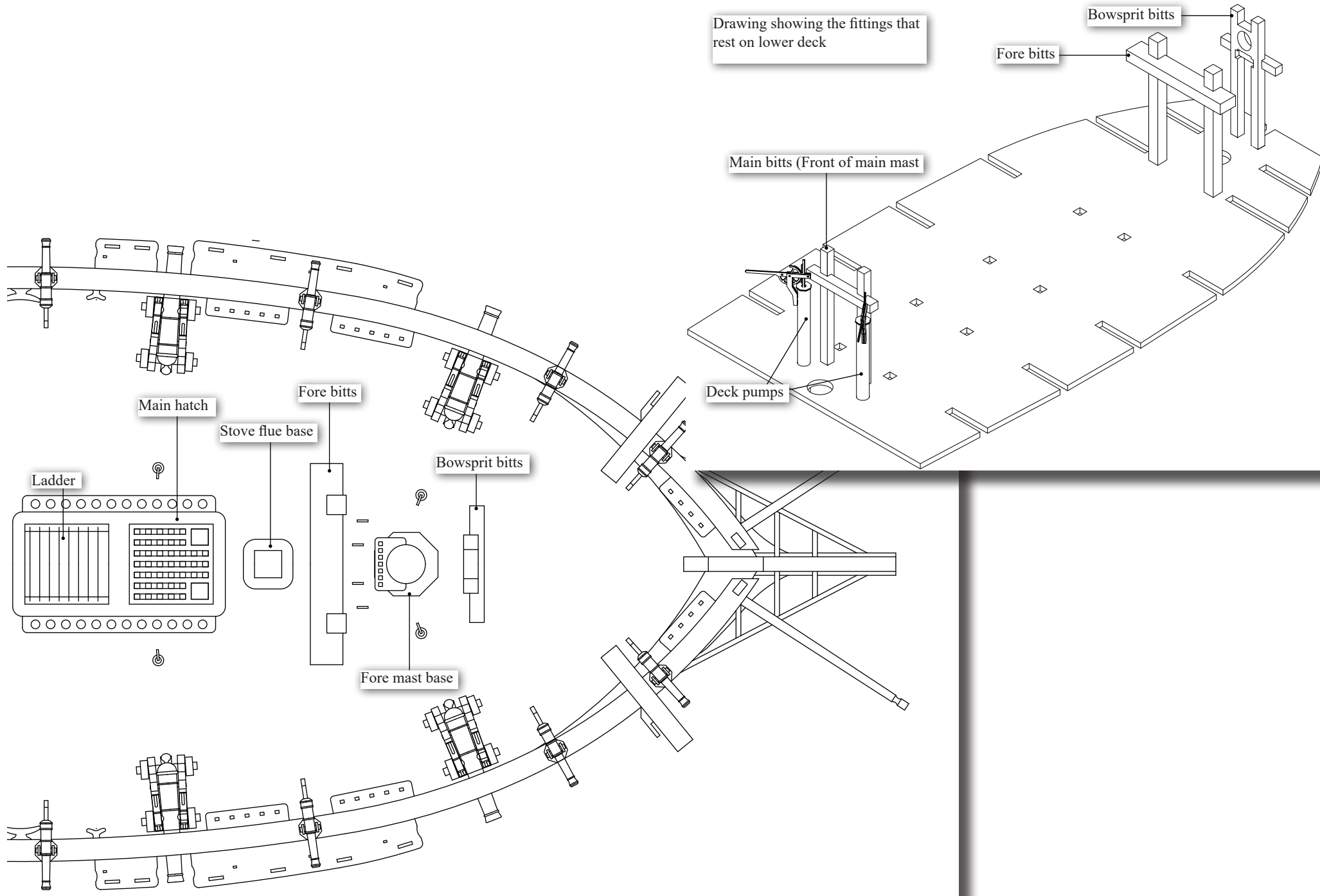

Drawing showing the fittings that rest on lower deck



130. Anchors: Remove all the Anchor Shank/Arm (A1) from the 2mm MDF sheet, and also the Anchor Stocks (114) from the 2mm wood sheet. From the 0.6mm PE sheet, remove the Anchor Rings (PE-44), and remove the Anchor Flukes, 39, from the 0.8mm ply sheet.



Glue the Flukes to the Shank/Arm parts, and also glue the Anchor Stocks together.

Use thin strips of black cartridge paper F-38 to create the iron bands. Paint the anchors black and glue them into the stocks. Fit the anchor rings and also paint those black. You can use some metallic pigment here too, to give more realism.

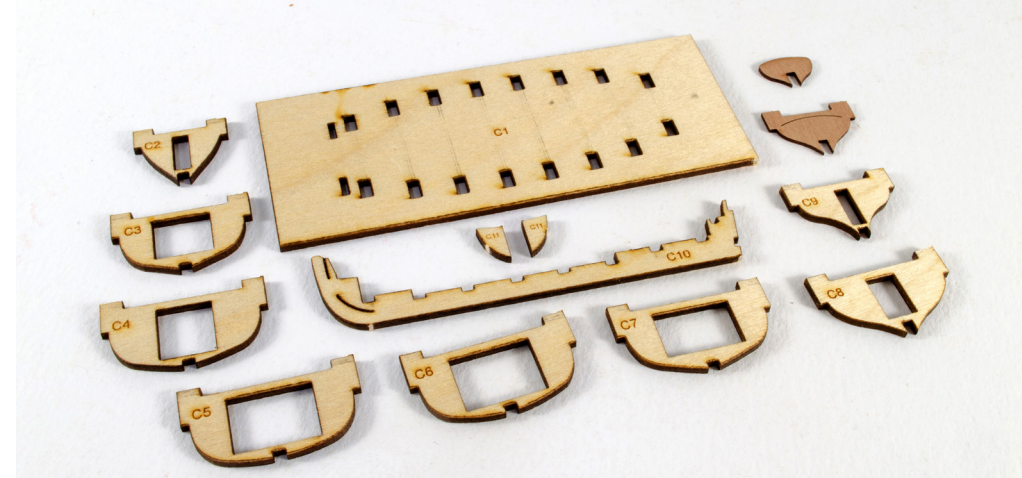

131. 18ft Cutter, *optional feature*: Flirt would have been fitted with a cutter like this. First, we need to build a jig for creating the hull. Cut out all parts from the 2mm MDF sheet (C1 – C11) Also cut out C14 and C15 (bulkhead and stern board) from the 1mm wood sheet. Glue parts C2 – C15 into position on the Cutter Keel C10, and lightly apply glue to a couple of these bulkheads and slot the frame/jig into the Frame Base C1.





132. Bevel and glue into position the Cutter bow planking patterns C11, as shown here. When these have dried, sand the frame smooth, or fair it. This allows for the planks to lie across them with most contact.

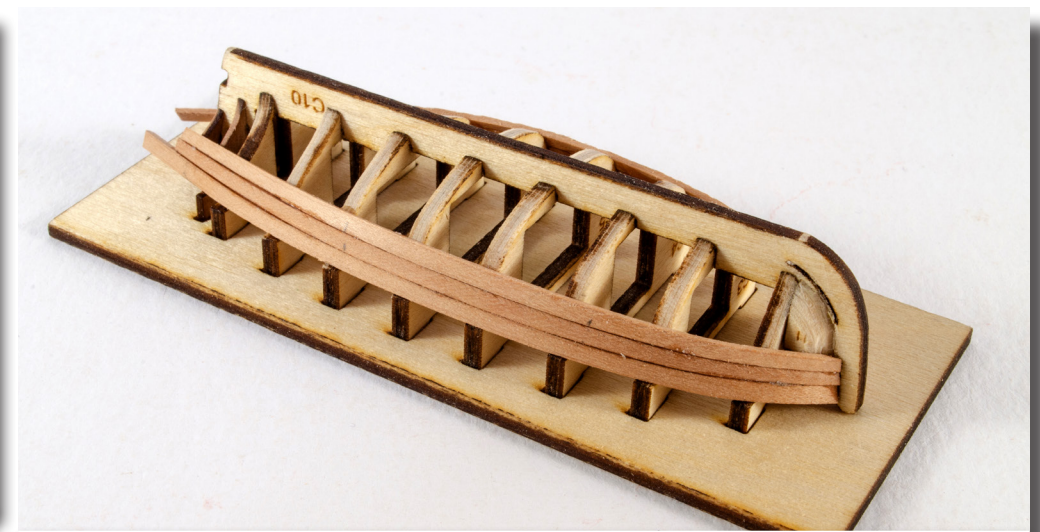

134. Run the first plank along the lip of the frames. You will need to bevel the front end of the plank to suit the bow curve. We opted to use CA gel for this as there should be no pin marks in the planks. Add additional planks and work towards the keel. Subsequent planks will need to be tapered slightly. To do this, check where the plank naturally tries to cross over the previous and make a pencil mark. From that pencil mark, cut a line towards the end of the plank, removing only about 20% of the plank width. You will need to taper and bow and stern. As you progress towards the keel and the planks don't sit easily, then let them run naturally and use small scraps of plank as stealers/infill. As a lot of the hull is painted, you won't see it.

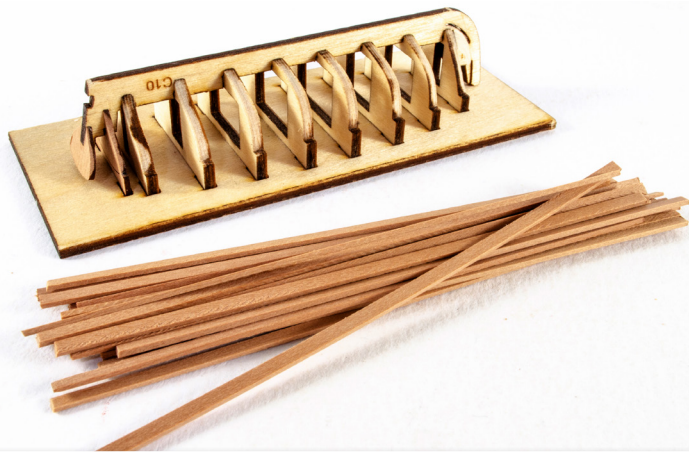

133. We will now plank the hull using the 1mm x 2mm x 100mm Pear Wood Strip (C23).





135. Gently remove the base C1 from the frame/jig. Very carefully twist the frames to remove them. If you feel more comfortable, use a razor saw and then a knife to trim them away. Still leave the bottom part of the frames in situ, as shown. Sand the interior if you need to create a better finish. The remainder of the frames are now hidden by the addition of the floor gratings, CPE-1, 2, 3 & 4. After painting these in a wooden colour, first glue the larger CPE-1 into position with CA. Follow this with the other parts.



136. Using 3mm x 1mm strip, cut into either 1mm or 1.3mm widths, add the internal ribs, spaced roughly as you see in the illustration. You may want to soak the wood if it won't push into the internal contours.



137. Now we need to fit the inside rail. I marked the top of the rail on my prototype as 2.5mm down from the top of the bulwark, but with evaluation, this would be better being located about 4mm from the top bulwark, but the sequence you see is the same. Split another 3mm strip and glue the rails 1.5mm wide, along the ribs using PVA and allow to set. Trim and sand the protruding ribs from the top of the bulwarks.

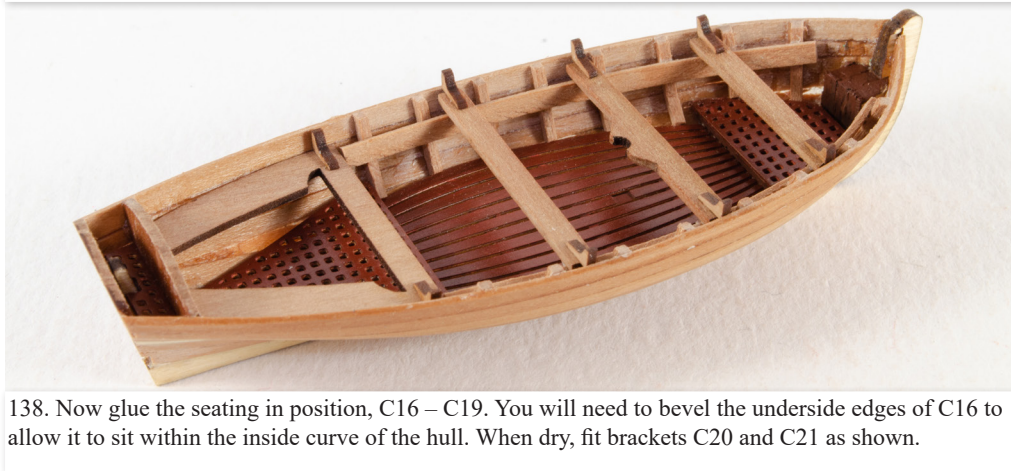

138. Now glue the seating in position, C16 – C19. You will need to bevel the underside edges of C16 to allow it to sit within the inside curve of the hull. When dry, fit brackets C20 and C21 as shown.

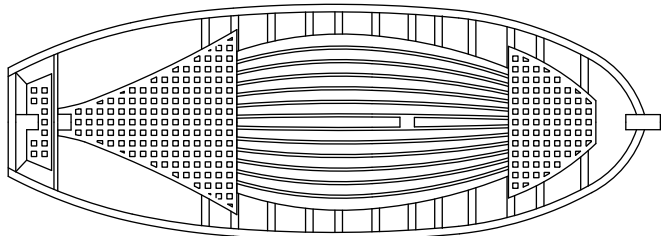

139. Mark the hull waterline using drawing reference and mask the model before spraying the underside with white paint.



140. Add a strip of 1.5mm x 1mm wood along the top of the bulwark so it sits at the same height as bulwark top. Paint this black. Add the gunwale by simply cutting 1mm x 3mm wood strip to 1.5mm width, and gluing to the top edge of the bulwarks, leaving 1mm gaps for the oars to sit.

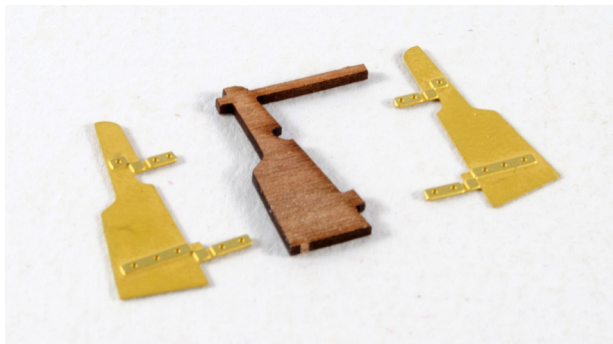

141. Remove the Cutter Rudder C22 from the 1mm wood sheet, and also Rudder Sides CPE-6 and CPE-7 from the 0.4mm brass sheet. Glue the parts together. Paint the rudder to match the hull, but with black above the waterline.



Drill a 0.8mm hole to accept the metal parts and glue using CA. Also drill a 0.8mm hole in the underside of the cradle parts and insert the sharp end of a brass pin so the cradle can be pinned to the deck.

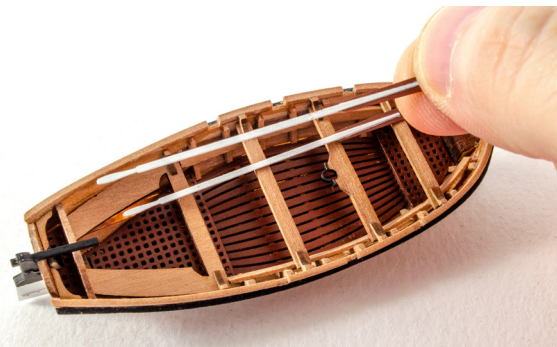

142. Assemble the kedge anchor and paint this black, along with the pikes. Paint the oar blades in a wooden colour and use white for the shafts. Position and glue these into the hull with CA.

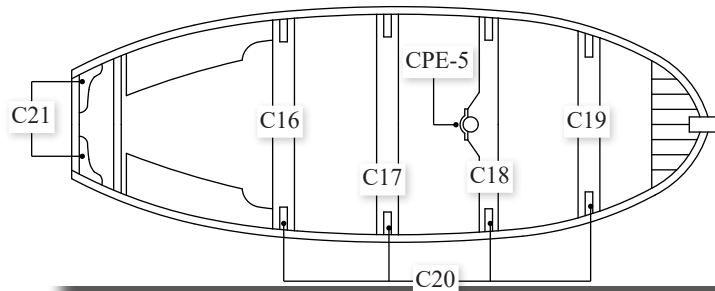

Glue the cradles to the cutter and use 0.5mm natural thread to lash the boat. The cutter can now be installed to the deck, or later, after main rigging.



143. Remove for Fore and Aft Cutter Cradle parts C12 and C13 and attach a Closed Eye-bolt PE-8 to one side, and a Small Cleat PE-33 to the other.

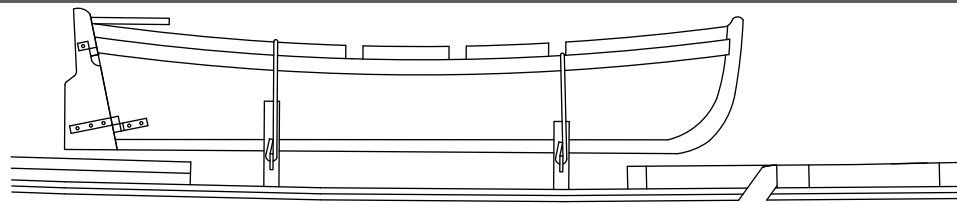
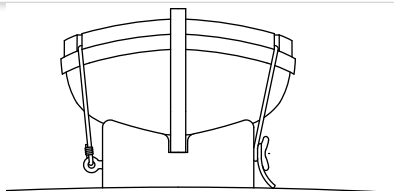



144- Masts, yards and rigging

Please note - The following is supplementary to the full size plans, and not a step-by-step building guide. Use the full size plans for all measurements and locations of parts and rigging.

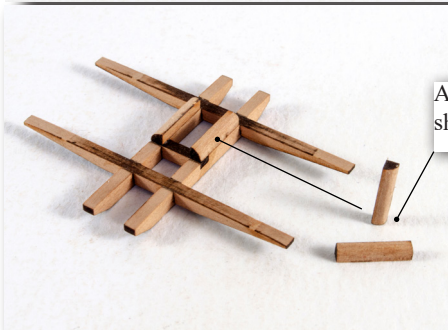
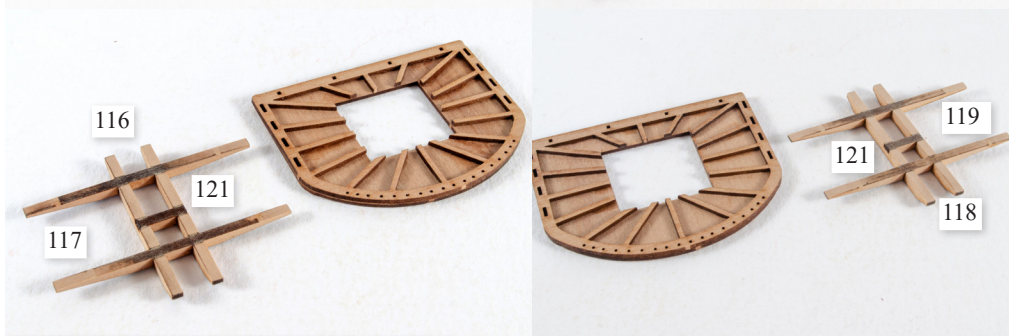
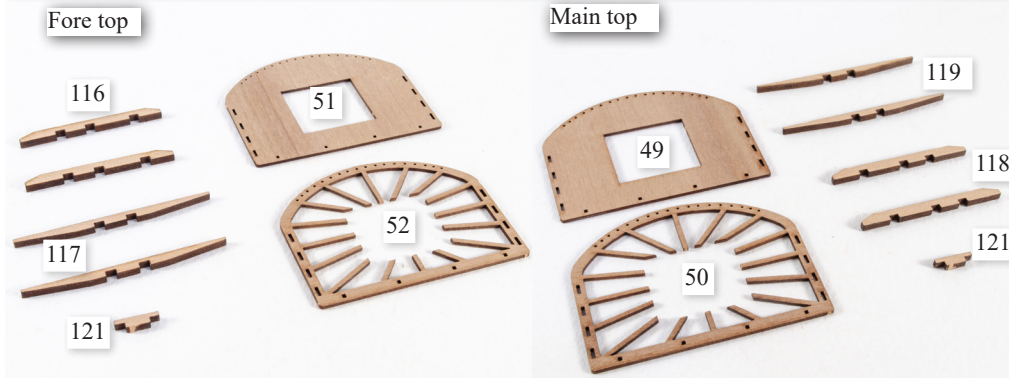

Add parts 120. Round off one edge to simulate the shroud bolsters and glue in place as shown

Fore and main lower top assemblies glued together

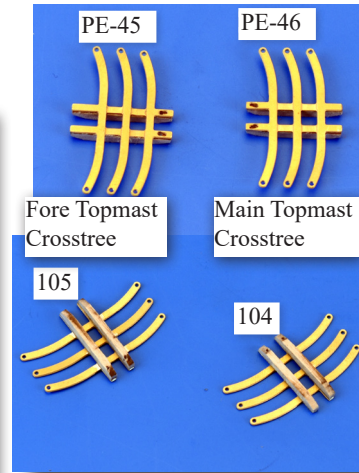

Mast sections shaped and ready to be fitted together.

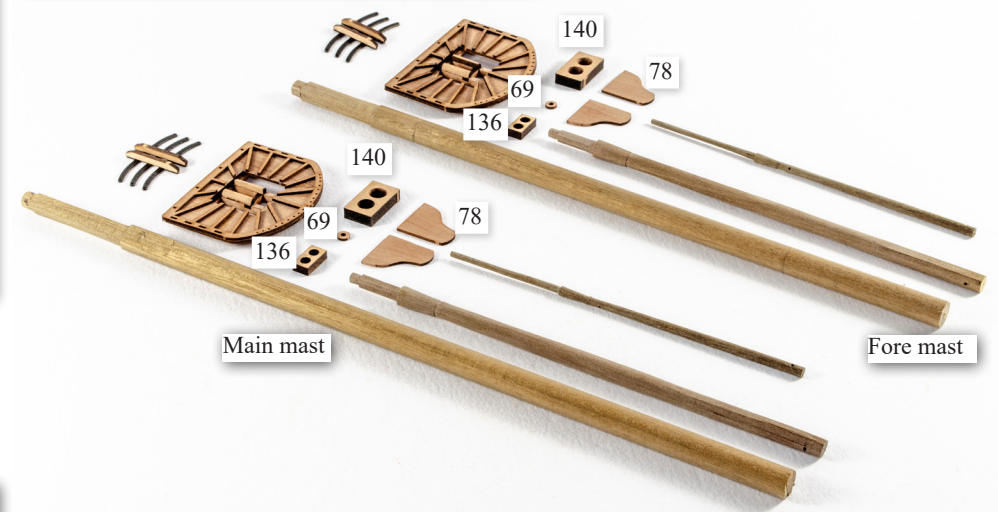

Fore and main lower masts and tops with cheeks in place



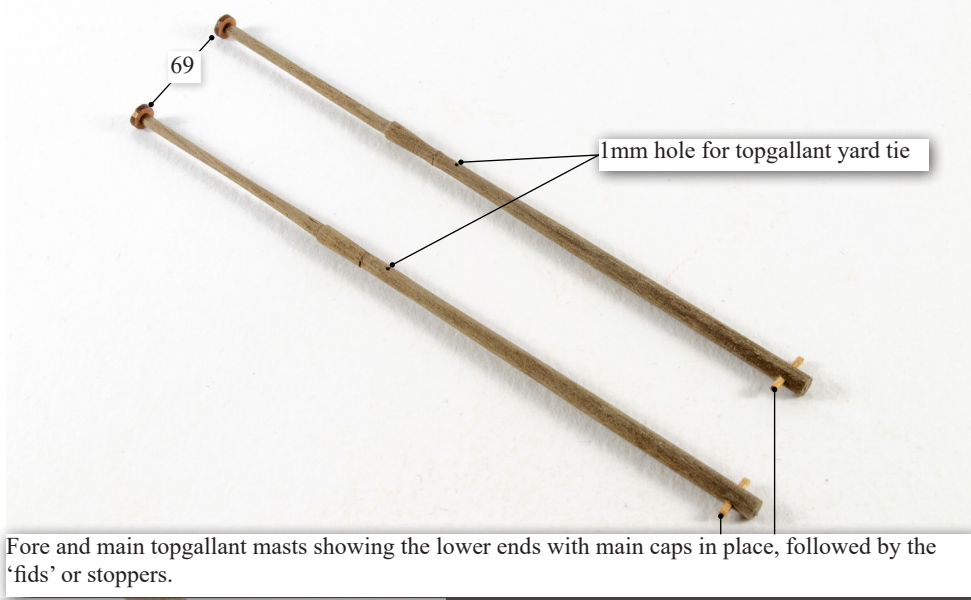

Fore and main topgallant masts showing the lower ends with main caps in place, followed by the 'fids' or stoppers.

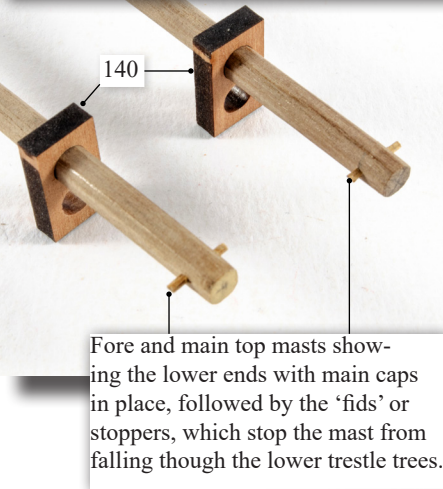

Fore and main top masts showing the lower ends with main caps in place, followed by the 'fids' or stoppers, which stop the mast from falling through the lower trestle trees.



Topmasts fitted to lower masts



Topgallant masts fitted to top masts



Lower tops with stanchions (PE-50) and rails (76 & 77) fitted

Fore and main masts complete. Refer to the full size plans for fitting and location of mast bands and cleats.

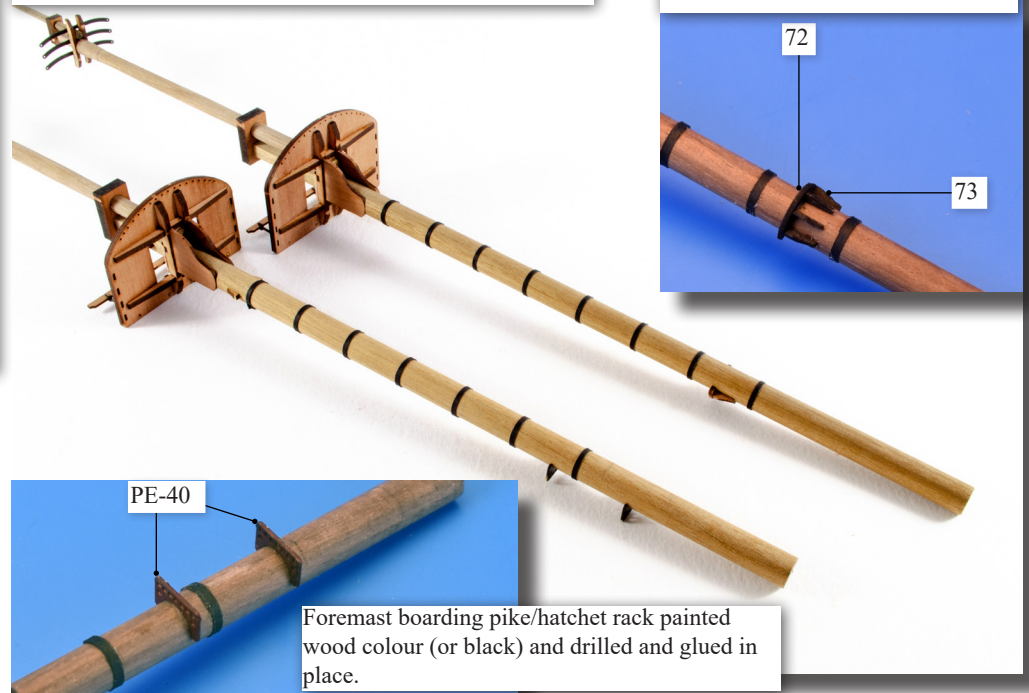

Main mast boom stool and brackets Painted black and glued in place.

PE-40 Foremast boarding pike/hatchet rack painted wood colour (or black) and drilled and glued in place.

Basic bowsprit assembly complete with cleats and eyebolts. Refer to the full size plans for exact locations



Gaff and boom

Black cartridge paper

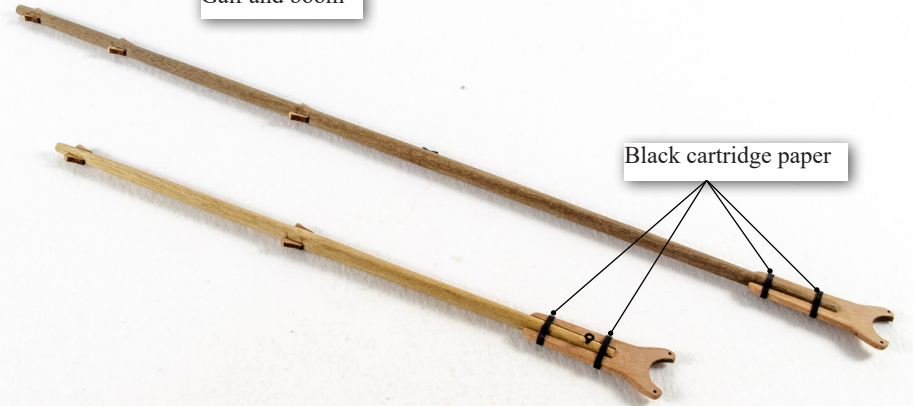

All yards and bowsprit complete and painted, ready for adding the various blocks

Topsail yard detail

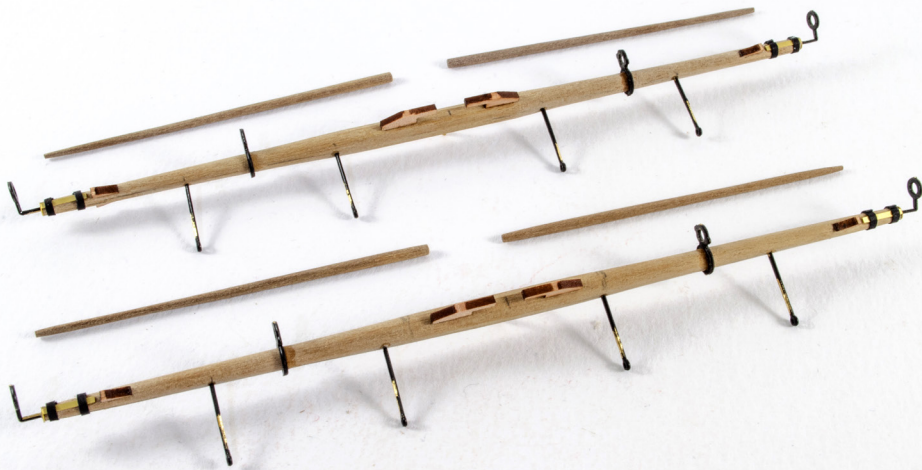

Paint all yards black except for the fore and main stun sail booms

Fore and Main yards complete and all blocks and foot ropes added

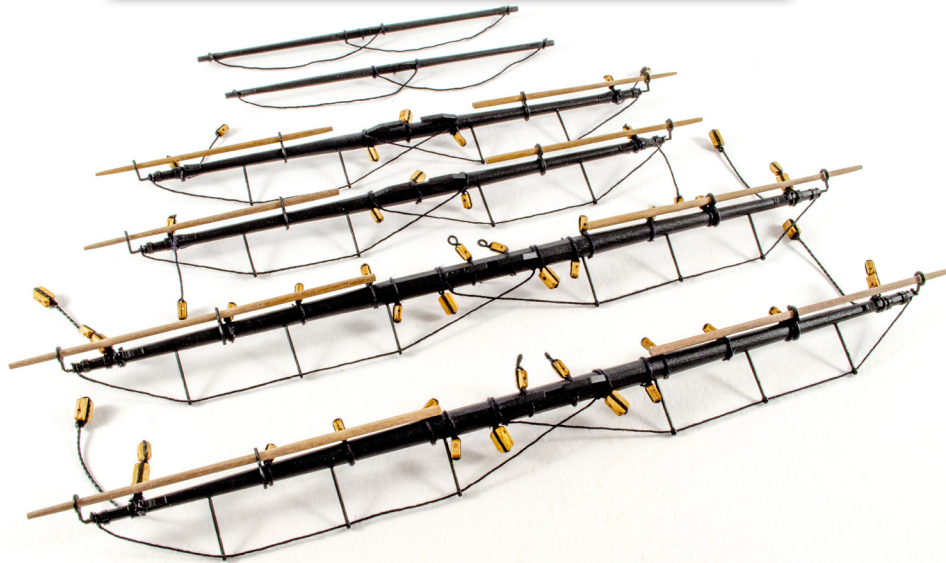

Flirt has two sizes of closed heart blocks, 7mm for the lower fore and main stays, and 6mm for the fore and main topmast stays. Both sizes are made as shown

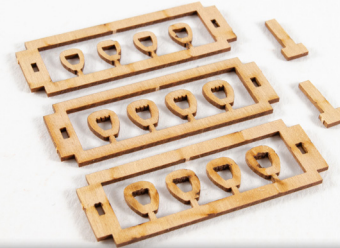
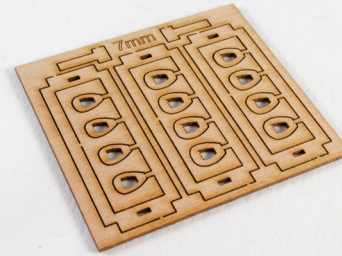

B - Note the smaller patterns, these fit in between the two larger patterns

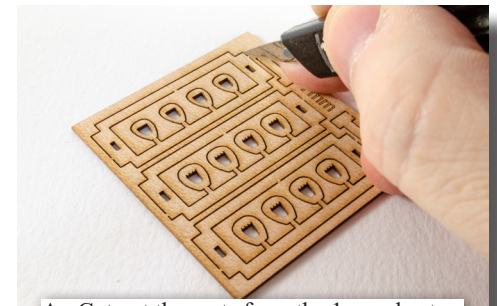

A - Cut out the parts from the 1mm sheet

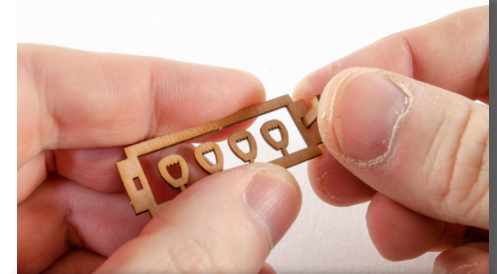

C - Slot the 'Keys' into the slots at the edge of the patterns

Bowsprit complete along with spritsail yard and gaff and boom yards with all blocks added

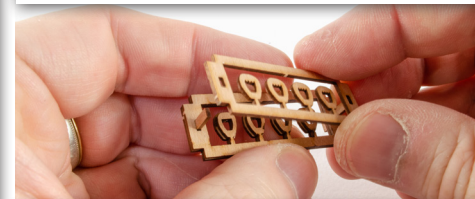

D - Apply a thin layer of PVA glue to the contact surface of the patterns and push together

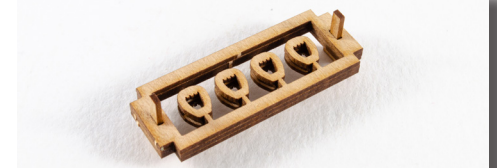

E - All three patterns glued together and kept aligned using the location keys

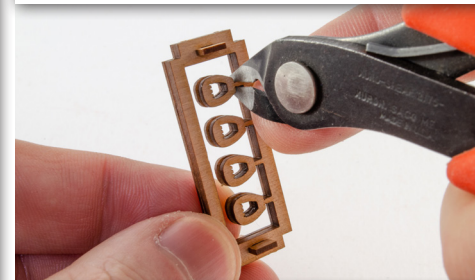

F - Once dry, carefully remove each complete block from its 'sprue'



G - File away any excess material in the tab area and the blocks are ready to use

Fore and Main masts complete and all blocks added following the plan sheets



The bowsprit is added first. Start with the gammoning and then rig the bowsprit stays, followed by the spritsail sail yard and associated rigging, as shown below and detailed in the rigging plans

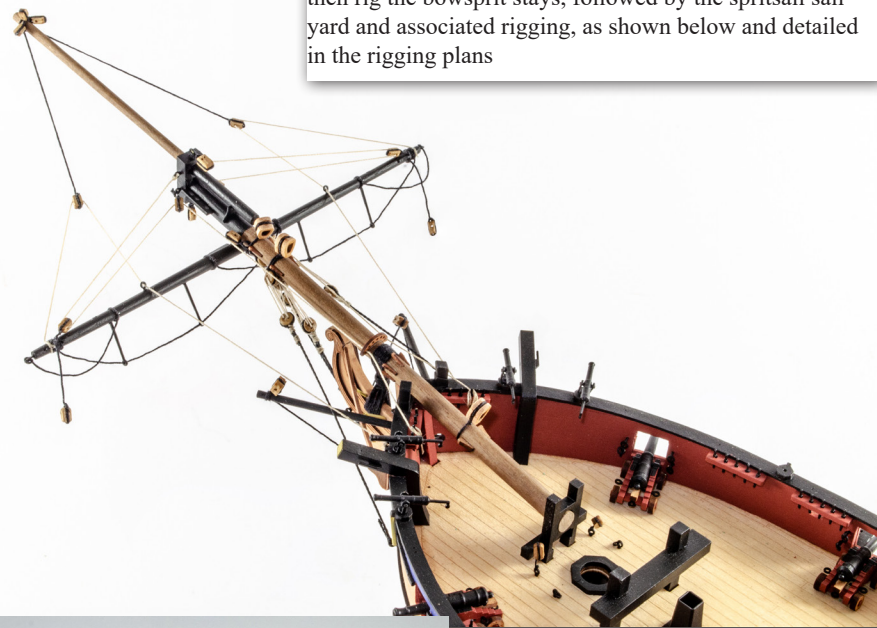

Foremast with closed heart block and boarding pike rack in place



Once the bowsprit has been rigged as far as it can be, add the fore and main mast assemblies.

The yards have been fitted at this point, but you can wait until the shrouds and ratlines have been rigged before adding them if you wish.

You can use a small drop of PVA wood glue at the bottom of each mast to make sure they do not move/rotate when adding the shrouds and back stays





Shroud sequence (The pictures are a compliment to the main rigging drawings, use the drawings for correct rigging line and deadeye/block sizes and placement)

Above - Lower shrouds are added first. Do not over tension any lines when rigging the lanyards to the deadeyes, even if this means that some shrouds are a little less taught than others.

Below - Once the lower shrouds have been set up, the 'Futtock Stave' can be added each side. These are simply 1mm brass rod cut overlong and tied in place to each of the shrouds. Carefully measure the distance from the lower tops to ensure both sides are aligned correctly. It is very easy to have one side higher or lower than the other.

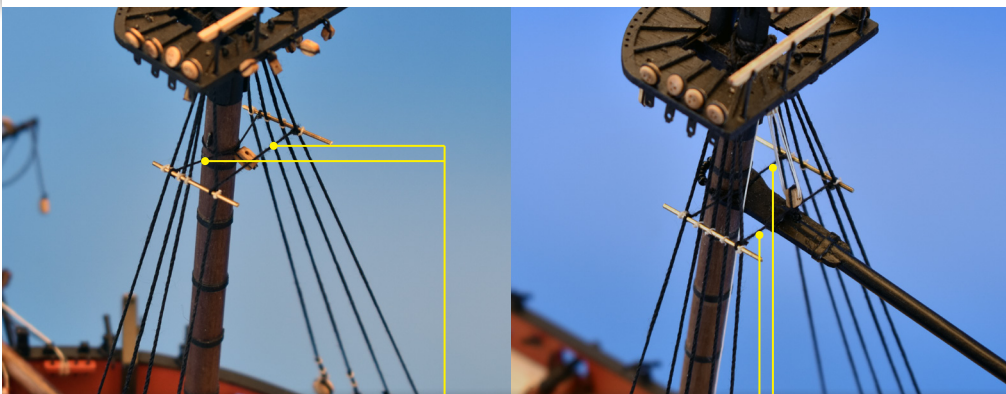

Above - To pull the top of the lower shrouds into the mast, 'catharpins' are rigged. These are simply thread secured to the left and right futtock staves.

Below - Make up 16 sets of 'Futtock Shrouds' These are black thread with a futtock hook tied into one end. Cut each to a length of approximately 80-90mm.

Right - The futtock shrouds hooked in place to the futtock strops. The lower end is secured to the shrouds, just below the futtock stave.

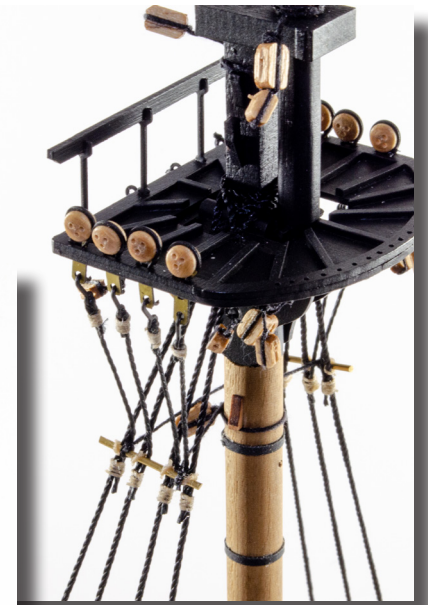

Left - Topmast shrouds added.

Below - Followed by the upper futtock staves (0.5mm brass rod) and catharpins.

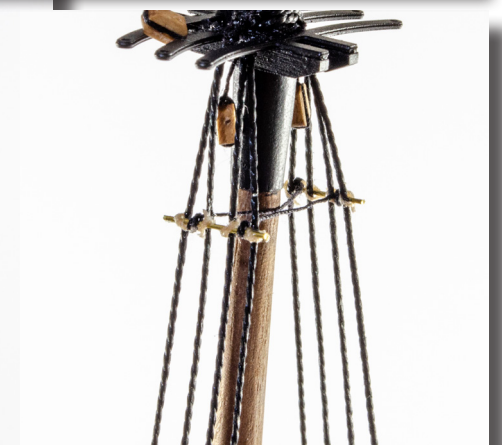



Ratlines tied into place. Before applying watered down PVA wood glue to the end knots, to secure them permanently in place, pull the excess ends of the ratlines to ensure the shrouds are not pulled in from the clove hitch knots of the ratlines.

Below - Brushing on watered down PVA wood glue to secure ratlines on first and last shrouds.

Below right - Once the PVA has cured, snip off the excess ratlines using scissors or a pair of side cutters. (Pictures below show Speedy, but method of applying ratlines is exactly the same for Flirt)

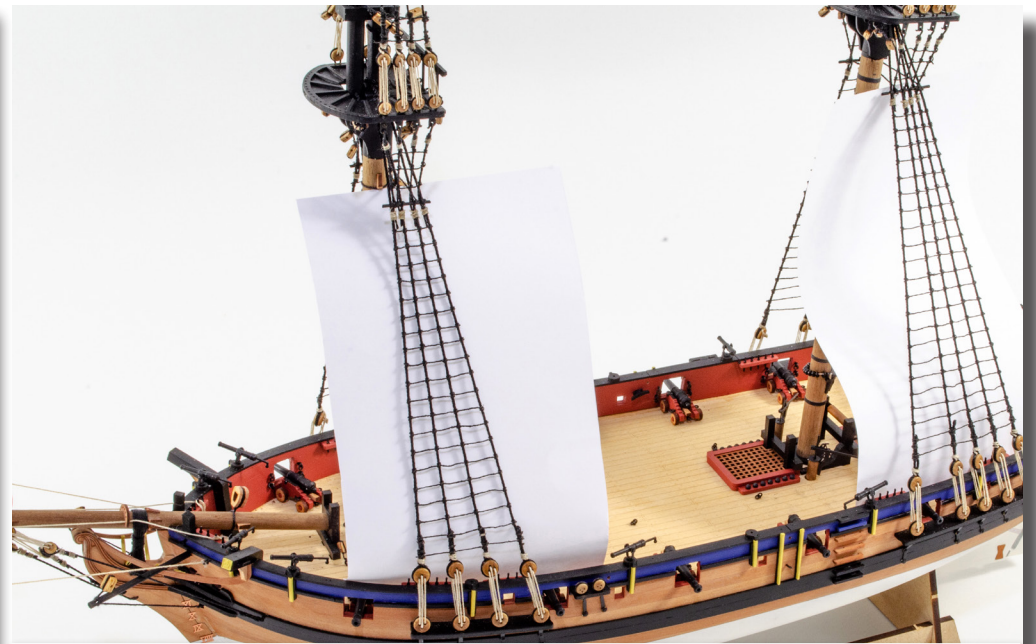
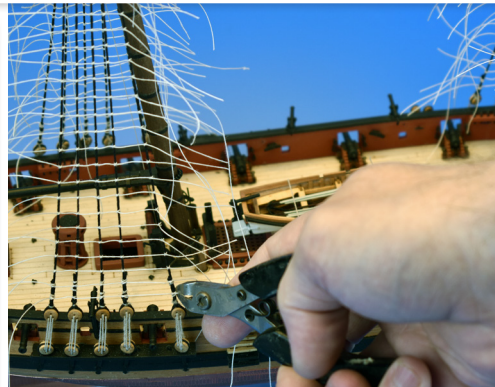

Above - ratlines now trimmed, ready for staining black.

To make sure no black paint or ink is splashed onto the model, add paper behind the shrouds to help prevent this. The prototype model shown had the ratlines stained by brushing on Black Indian Ink. The futtock staves were then painted black.

Below - Once the ratlines are complete, add the topgallant shrouds.

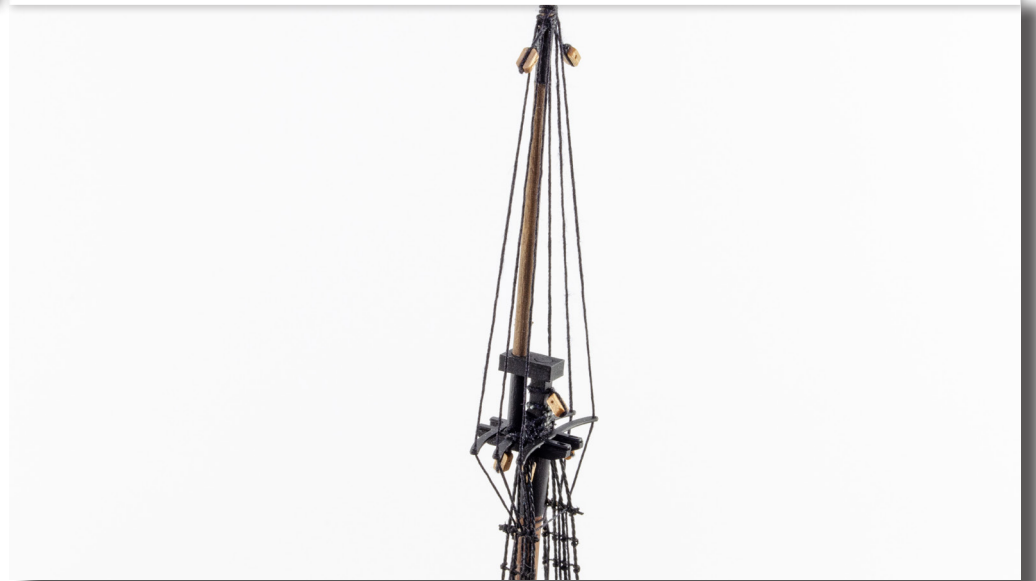



The fore hatch grating (63a). The anchor hawse rope (F-25) can be secured by the method shown on the right



Below - All mast stays rigged in place.

Above Right - Crowsfeet added to fore and main stays.

Right - Fore and main stays showing the closed heart blocks and lanyards to secure in place.



Flirt rigging continued - Use the rigging plans for full reference

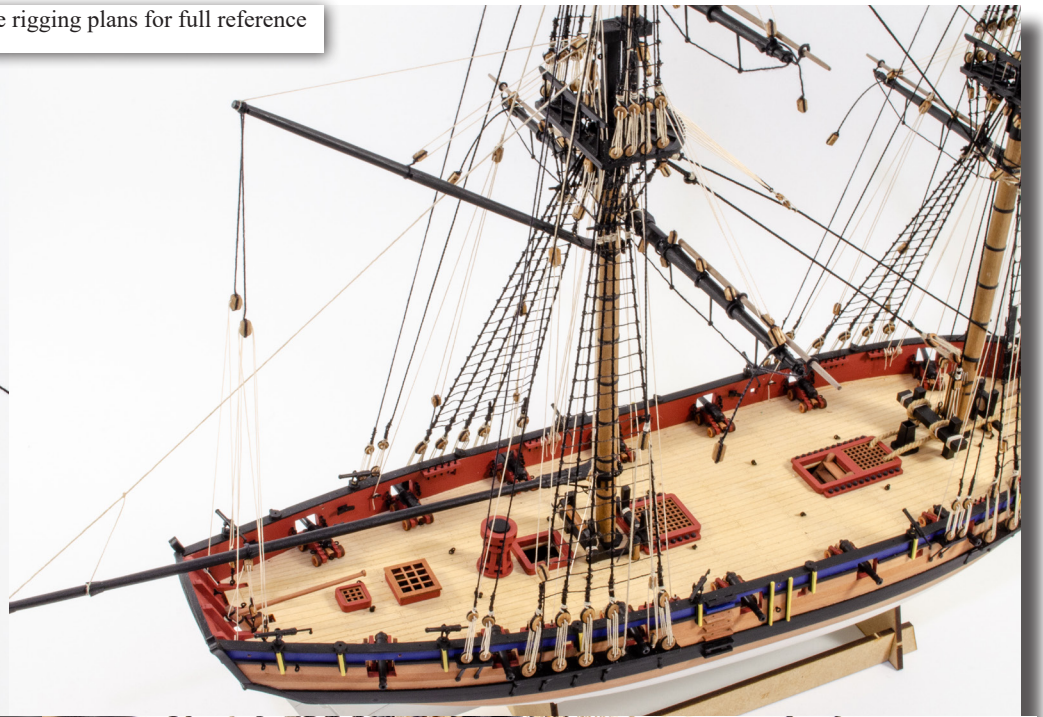

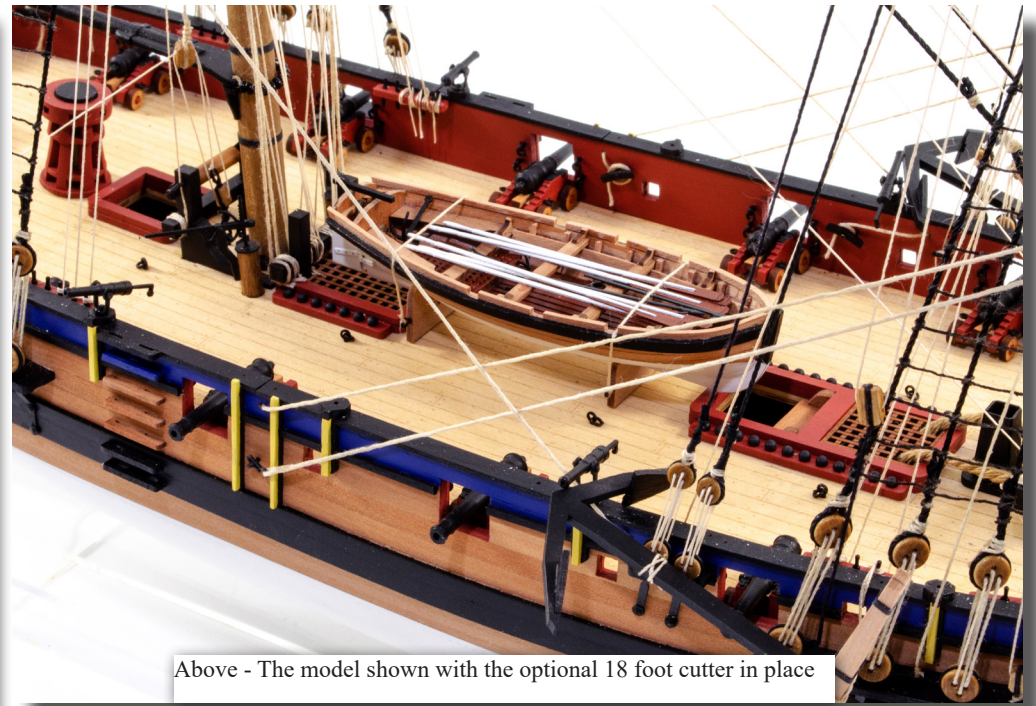

Above - The model shown with the optional 18 foot cutter in place



**HM Brig Sloop Flirt – 1:64th scale
PARTS LIST**

| <u>Pt. No</u> | <u>Description</u> | <u>Material</u> | <u>QTY</u> |
|----------------|--|-----------------|------------|
| 3mm MDF | | | |
| 1 | False Keel | 3mm MDF | 1 |
| 2 | Bulkhead | 3mm MDF | 1 |
| 3 | Bulkhead | 3mm MDF | 1 |
| 4 | Bulkhead | 3mm MDF | 1 |
| 5 | Bulkhead | 3mm MDF | 1 |
| 6 | Bulkhead | 3mm MDF | 1 |
| 6a | Deck Beam | 3mm MDF | 2 |
| 7 | Bulkhead | 3mm MDF | 1 |
| 7a | Deck Beam | 3mm MDF | 1 |
| 8 | Bulkhead | 3mm MDF | 1 |
| 8a | Deck Beam | 3mm MDF | 1 |
| 9 | Bulkhead | 3mm MDF | 1 |
| 9a | Deck Beam | 3mm MDF | 2 |
| 10 | Bulkhead | 3mm MDF | 1 |
| 11 | Bulkhead | 3mm MDF | 1 |
| 11a | Deck Beam | 3mm MDF | 1 |
| 12 | Bulkhead | 3mm MDF | 1 |
| 12a | Deck Beam | 3mm MDF | 1 |
| 13 | Bulkhead | 3mm MDF | 1 |
| 14 | Bulkhead | 3mm MDF | 1 |
| 15 | Bulkhead | 3mm MDF | 1 |
| 16 | Bulkhead | 3mm MDF | 1 |
| 17 | Bow Pattern (Inner) | 3mm MDF | 2 |
| 18 | Bow Pattern (Outer) | 3mm MDF | 2 |
| 19 | Bow patterns (Between bulkheads 3&4) | 3mm MDF | 2 |
| 20 | Bow patterns (Between bulkheads 2&3) | 3mm MDF | 2 |
| 21 | Stern patterns (Between bulkheads 14&15) | 3mm MDF | 2 |
| 22 | Fore/aft lower deck step pattern | 3mm MDF | 2 |
| 23 | Upper deck longitudinal support | 3mm MDF | 2 |
| 24 | Securing Peg (To keep keel parts in place) | 3mm MDF | 4 |
| 25 | Sacrificial building cradle (Fore) | 3mm MDF | 1 |
| 26 | Sacrificial building cradle (Aft) | 3mm MDF | 1 |
| 27 | Sacrificial building cradle spacer | 3mm MDF | 1 |

| <u>Pt. No</u> | <u>Description</u> | <u>Material</u> | <u>QTY</u> |
|--------------------------|-----------------------------|-----------------|------------|
| 2mm Birch Plywood | | | |
| 28 | Lower deck (Fore) | 2mm Plywood | 2 |
| 29 | Lower deck (Aft) | 2mm Plywood | 2 |
| 30 | Stern frame pattern (Inner) | 2mm Plywood | 2 |
| 31 | Stern frame pattern (Outer) | 2mm Plywood | 2 |

| 2mm MDF (Cutter parts for MS version in 2mm Plywood) | | | |
|---|-------------------------------------|---------|---|
| A1 | Anchor Pattern | 2mm MDF | 4 |
| C1 | 18 Foot Cutter Frame base | 2mm MDF | 1 |
| C2 | 18 Foot Cutter Frame | 2mm MDF | 1 |
| C3 | 18 Foot Cutter Frame | 2mm MDF | 1 |
| C4 | 18 Foot Cutter Frame | 2mm MDF | 1 |
| C5 | 18 Foot Cutter Frame | 2mm MDF | 1 |
| C6 | 18 Foot Cutter Frame | 2mm MDF | 1 |
| C7 | 18 Foot Cutter Frame | 2mm MDF | 1 |
| C8 | 18 Foot Cutter Frame | 2mm MDF | 1 |
| C9 | 18 Foot Cutter Frame | 2mm MDF | 1 |
| C10 | 18 Foot Cutter Keel | 2mm MDF | 1 |
| C11 | 18 Foot Cutter bow planking pattern | 2mm MDF | 2 |
| C12 | 18 Foot Cutter cradle (Fore) | 2mm MDF | 1 |
| C13 | 18 Foot Cutter cradle (Aft) | 2mm MDF | 1 |

| 2mm Clear Acetate | | | |
|--------------------------|--------------------------------|-------------------|---|
| 32 | Display cradle (Fore) | 3mm Clear Acetate | 1 |
| 33 | Display cradle (Aft) | 3mm Clear Acetate | 1 |
| 34 | Display cradle spacer (Centre) | 3mm Clear Acetate | 1 |
| 35 | Display cradle spacer (Sides) | 3mm Clear Acetate | 2 |

| 0.8mm Plywood | | | |
|----------------------|---|---------------|---|
| 36 | Main deck | 0.8mm Plywood | 1 |
| 37 | Side bulwark pattern (Fore) | 0.8mm Plywood | 2 |
| 37a | Side bulwark pattern (Aft) | 0.8mm Plywood | 2 |
| 38 | Stern counter | 0.8mm Plywood | 1 |
| 39 | Anchor pattern | 0.8mm Plywood | 8 |
| 40 | Upper rail and swivel gun post pattern (Fore) | 0.8mm Plywood | 2 |
| 40a | Swivel gun post support timber | 0.8mm Plywood | 2 |
| 40b | Swivel gun post support timber | 0.8mm Plywood | 2 |
| 41 | Upper rail and swivel gun post pattern | 0.8mm Plywood | 2 |
| 41a | Swivel gun post support timber | 0.8mm Plywood | 2 |

| Pt. No | Description | Material | QTY |
|---------------|--|-----------------|------------|
| 41b | Swivel gun post support timber | 0.8mm Plywood | 2 |
| 42 | Upper rail and swivel gun post pattern | 0.8mm Plywood | 2 |
| 42a | Swivel gun post support timber | 0.8mm Plywood | 2 |
| 42b | Side fender timber | 0.8mm Plywood | 4 |
| 42c | Swivel gun post support timber | 0.8mm Plywood | 2 |
| 43 | Upper rail and swivel gun post pattern | 0.8mm Plywood | 2 |
| 43a | Swivel gun post support timber | 0.8mm Plywood | 2 |
| 43b | Swivel gun post support timber | 0.8mm Plywood | 2 |
| 44 | Upper rail and swivel gun post pattern | 0.8mm Plywood | 2 |
| 44a | Swivel gun post support timber | 0.8mm Plywood | 2 |
| 44b | Swivel gun post support timber | 0.8mm Plywood | 2 |

1mm Wood

| | | | |
|-----|--------------------------------------|----------|---|
| 10A | Door to Captain's Cabin | 1mm Wood | 1 |
| 45L | Hair bracket (Left) | 1mm Wood | 1 |
| 45R | Hair bracket (Right) | 1mm Wood | 1 |
| 46 | Bow main rail | 1mm Wood | 2 |
| 47 | Capstan lower chock | 1mm Wood | 1 |
| 48 | Capstan upper chock | 1mm Wood | 1 |
| 49 | Main top (Lower pattern) | 1mm Wood | 1 |
| 50 | Main top (Upper pattern) | 1mm Wood | 1 |
| 51 | Fore top (Lower pattern) | 1mm Wood | 1 |
| 52 | Fore top (Upper pattern) | 1mm Wood | 1 |
| 53 | Stern board | 1mm Wood | 1 |
| 54 | Bowsprit fairlead cleat (1 required) | 1mm Wood | 2 |
| 55 | Jibboom Saddle (1 required) | 1mm Wood | 2 |
| 56 | Bowsprit Bee | 1mm Wood | 2 |
| 57 | Stern Side Counter Timber | 1mm Wood | 2 |
| 58 | 'FLIRT' Laser Etched Nameplate | 1mm Wood | 2 |
| 59 | Forward Gunwale | 1mm Wood | 2 |
| 59a | Aft Gunwale | 1mm Wood | 2 |
| 60 | Stern board Upper Rail | 1mm Wood | 1 |
| 61 | Stern board Middle Rail | 1mm Wood | 1 |
| 62 | Stern board Lower Rail | 1mm Wood | 1 |
| 63a | Forward Hatch Grating | 1mm Wood | 1 |
| 63b | Main Hatch Grating | 1mm Wood | 1 |
| 63c | Aft Hatch Grating | 1mm Wood | 1 |
| 64 | Skylight Frame | 1mm Wood | 1 |
| 65 | Aft Ladder Inner Side | 1mm Wood | 2 |
| 65L | Aft Ladder Outer Side (Left) | 1mm Wood | 1 |
| 65R | Aft Ladder Outer Side (Right) | 1mm Wood | 1 |
| 66 | Aft Ladder Step | 1mm Wood | 8 |

| Pt. No | Description | Material | QTY |
|---------------|--------------------------------------|-----------------|------------|
| 67 | Fore Ladder Inner Side | 1mm Wood | 2 |
| 67L | Fore Ladder Outer Side (Left) | 1mm Wood | 1 |
| 67R | Fore Ladder Outer Side (Right) | 1mm Wood | 1 |
| 68 | Fore Ladder Step | 1mm Wood | 8 |
| 69 | Fore and Main Topgallant Mast Truck | 1mm Wood | 2 |
| 70 | Capstan Top | 1mm Wood | 1 |
| 71 | Capstan Ring | 1mm Wood | 2 |
| 72 | Aft Boom Hound | 1mm Wood | 1 |
| 73 | Supports for Part 71 | 1mm Wood | 4 |
| 74 | Side Step | 1mm Wood | 20 |
| 75 | Tiller Arm | 1mm Wood | 2 |
| 76 | Main Top Rail | 1mm Wood | 1 |
| 77 | Fore Top Rail | 1mm Wood | 1 |
| 78 | Fore and Main Mast Cheek | 1mm Wood | 4 |
| 79 | Anchor Hawse Bolster | 1mm Wood | 2 |
| 80 | Aft Skylight Combing (Female) | 1mm Wood | 2 |
| 81 | Aft Skylight Combing (Male) | 1mm Wood | 2 |
| 82 | Yard Cleat | 1mm Wood | 61 |
| HB-6a | 6mm Closed heart Block Outer Pattern | 1mm Wood | 2 |
| HB-6B | 6mm Closed heart Block Inner Pattern | 1mm Wood | 1 |
| HB-6C | 6mm Closed heart Block Alignment Key | 1mm Wood | 2 |
| HB-7a | 7mm Closed heart Block Outer Pattern | 1mm Wood | 2 |
| HB-7B | 7mm Closed heart Block Inner Pattern | 1mm Wood | 1 |
| HB-7C | 7mm Closed heart Block Alignment Key | 1mm Wood | 2 |

18 Foot Cutter (Master Shipwright Edition)

| | | | |
|-----|------------------------------|----------|---|
| C14 | 18 Foot Cutter bulkhead | 1mm Wood | 1 |
| C15 | 18 Foot Cutter stern board | 1mm Wood | 1 |
| C16 | 18 Foot Cutter seat (Rear) | 1mm Wood | 1 |
| C17 | 18 Foot Cutter seat | 1mm Wood | 1 |
| C18 | 18 Foot Cutter seat | 1mm Wood | 1 |
| C19 | 18 Foot Cutter seat | 1mm Wood | 1 |
| C20 | 18 Foot Cutter seat bracket | 1mm Wood | 8 |
| C21 | 18 Foot Cutter stern bracket | 1mm Wood | 2 |
| C22 | 18 Foot Cutter rudder | 1mm Wood | 1 |

1.5mm Wood

| <u>Pt. No</u> | <u>Description</u> | <u>Material</u> | <u>QTY</u> |
|---------------|--|-----------------|------------|
| 84 | Lower Yard Sling Cleat | 1.5mm Wood | 8 |
| 85 | Upper Yard Sling Cleat | 1.5mm Wood | 12 |
| 86 | Lower Mast Top Closed Cleat | 1.5mm Wood | 8 |
| 87 | Deck/Bulwark Cleat | 1.5mm Wood | 11 |
| 88 | Forward Hatch and ladder Combing (Lower) | 1.5mm Wood | 1 |
| 88a | Forward Hatch and ladder Combing (Upper) | 1.5mm Wood | 1 |
| 89 | Main Hatch Combing (Lower) | 1.5mm Wood | 1 |
| 89a | Main Hatch Combing (Upper) | 1.5mm Wood | 1 |
| 90 | Aft Ladderway Combing | 1.5mm Wood | 2 |
| 91 | Bread Room Hatch Combing (Lower) | 1.5mm Wood | 1 |
| 91a | Bread Room Hatch Combing (Upper) | 1.5mm Wood | 1 |
| 92 | Flue/Chimney Combing | 1.5mm Wood | 1 |
| 93 | Capstan Bar Ring | 1.5mm Wood | 1 |
| 94 | Capstan Top Ring | 1.5mm Wood | 1 |
| 95 | Gaff/Boom Jaws | 1.5mm Wood | 2 |
| 96 | Belaying Pin Rack (4-Pin) | 1.5mm Wood | 2 |
| 96a | Belaying Pin Rack (5-Pin) | 1.5mm Wood | 8 |
| 97 | Fore and Main Mast Base | 1.5mm Wood | 2 |
| 98 | Cathead Knee | 1.5mm Wood | 2 |
| 99 | Bow Upper and Lower Cheek | 1.5mm Wood | 4 |
| 100 | Fore Channel | 1.5mm Wood | 2 |
| 101 | Main Channel | 1.5mm Wood | 2 |
| 102 | Fore and Main Stool Channel | 1.5mm Wood | 4 |
| 103 | Half-Pounder Gun Base | 1.5mm Wood | 26 |
| 104 | Main Topmast Trestle Tree | 1.5mm Wood | 2 |
| 105 | Fore Topmast Trestle Tree | 1.5mm Wood | 2 |
| 106 | 4-Pounder carriage side (Right) | 1.5mm Wood | 14 |
| 107 | 4-Pounder carriage side (Left) | 1.5mm Wood | 14 |
| 108 | 4-Pounder carriage front axle | 1.5mm Wood | 16 |
| 109 | 4-Pounder carriage rear axle | 1.5mm Wood | 16 |
| 110 | 4-Pounder carriage Bed | 1.5mm Wood | 14 |
| 111 | 4-Pounder carriage quoin | 1.5mm Wood | 14 |
| 112 | 4-Pounder carriage front wheel | 1.5mm Wood | 32 |
| 113 | 4-Pounder carriage rear wheel | 1.5mm Wood | 32 |

2mm Wood

| <u>Pt. No</u> | <u>Description</u> | <u>Material</u> | <u>QTY</u> |
|---------------|---------------------------------------|-----------------|------------|
| 114 | Anchor Stock | 2mm Wood | 8 |
| 115 | Capstan Whelp | 2mm Wood | 8 |
| 116 | Fore Trestletree | 2mm Wood | 2 |
| 117 | Fore Crosstree | 2mm Wood | 2 |
| 118 | Main Trestletree | 2mm Wood | 2 |
| 119 | Main Crosstree | 2mm Wood | 2 |
| 120 | Lower top bolsters (Requires sanding) | 2mm Wood | 4 |
| 121 | Fore and Main Trestletree spacer | 2mm Wood | 2 |

3mm Wood

| | | | |
|-----|---|----------|---|
| 122 | Inner Stem post | 3mm Wood | 1 |
| 123 | Stem pattern | 3mm Wood | 1 |
| 124 | Keel (Fore) | 3mm Wood | 1 |
| 125 | Keel (Aft) | 3mm Wood | 1 |
| 126 | Stern/Rudder Post | 3mm Wood | 1 |
| 127 | Rudder | 3mm Wood | 1 |
| 128 | Crutch for boom | 3mm Wood | 2 |
| 129 | Bow Timberhead | 3mm Wood | 2 |
| 130 | Bowsprit post | 3mm Wood | 1 |
| 131 | Bowsprit Post cross beam | 3mm Wood | 1 |
| 132 | Main Bitt Post (Front of mast) | 3mm Wood | 2 |
| 133 | Main Bitt Post cross beam (Front of mast) | 3mm Wood | 1 |
| 134 | Main Bitt Post (Aft of mast) | 3mm Wood | 2 |
| 135 | Main Bitt Post cross beam (Aft of mast) | 3mm Wood | 1 |
| 136 | Fore and Main lower top mast cap | 3mm Wood | 2 |

4mm Wood

| | | | |
|-----|------------------------------|----------|---|
| 137 | Fore Bitt post | 4mm Wood | 2 |
| 138 | Fore Bitt post cross beam | 4mm Wood | 1 |
| 139 | Cathead | 4mm Wood | 2 |
| 140 | Fore and main lower mast cap | 4mm Wood | 2 |
| 141 | Bowsprit cap | 4mm Wood | 1 |

0.8mm Laser Engraved Plywood

| <u>Pt. No</u> | <u>Description</u> | <u>Material</u> | <u>QTY</u> |
|---------------|--------------------|-----------------|------------|
| 142 | Deck with planking | 0.8mm Plywood | 1 |

0.2mm Photo Etched Brass

| | | | |
|-------|---|------------------|----|
| PE-1 | Horseshoe Plate | 0.2mm Photo Etch | 2 |
| PE-2 | Fish Plate | 0.2mm Photo Etch | 2 |
| PE-3 | 4-Pounder carriage cap square | 0.2mm Photo Etch | 32 |
| PE-4 | Lower yard stun sail boom outer bracket | 0.2mm Photo Etch | 4 |
| PE-5 | Upper yard stun sail boom outer bracket | 0.2mm Photo Etch | 4 |
| PE-6 | Cathead end cap decoration | 0.2mm Photo Etch | 2 |
| PE-7 | Depth Markings | 0.2mm Photo Etch | 2 |
| PE-8 | Rudder Gudgeon and Pintle Brace | 0.2mm Photo Etch | 1 |
| PE-9 | Rudder Gudgeon and Pintle Brace | 0.2mm Photo Etch | 1 |
| PE-10 | Rudder Gudgeon and Pintle Brace | 0.2mm Photo Etch | 1 |
| PE-11 | Rudder Gudgeon and Pintle Brace | 0.2mm Photo Etch | 2 |
| PE-12 | Rudder Gudgeon and Pintle Brace | 0.2mm Photo Etch | 2 |
| PE-13 | Rudder Gudgeon and Pintle Brace | 0.2mm Photo Etch | 2 |

0.4mm Photo Etched Brass

| | | | |
|--------|------------------------------------|------------------|-----|
| PE-14 | Open eyebolt (For PE-14a) | 0.4mm Photo Etch | 80 |
| PE-14a | Ring for open eyebolt (For PE-14) | 0.4mm Photo Etch | 80 |
| PE-15 | Closed eyebolt | 0.4mm Photo Etch | 145 |
| PE-16 | Topmast Yard rib | 0.4mm Photo Etch | 24 |
| PE-17 | Rigging hook | 0.4mm Photo Etch | 47 |
| PE-18 | 5mm Deadeye strop and chain plate | 0.4mm Photo Etch | 20 |
| PE-19 | 3mm Deadeye strop and chain plate | 0.4mm Photo Etch | 10 |
| PE-20 | 3mm Deadeye futtock strop | 0.4mm Photo Etch | 18 |
| PE-21 | 3mm Deadeye futtock strop hook | 0.4mm Photo Etch | 24 |
| PE-22 | 4-Pounder carriage 'Traverse Bolt' | 0.4mm Photo Etch | 16 |
| PE-23 | Drum windlass pawl | 0.4mm Photo Etch | 2 |
| PE-24 | Half-Pounder swivel gun bracket | 0.4mm Photo Etch | 21 |
| PE-25 | Stove flue | 0.4mm Photo Etch | 1 |
| PE-26 | Deck pump main body side frame | 0.4mm Photo Etch | 4 |
| PE-27 | Deck pump main body | 0.4mm Photo Etch | 2 |
| PE-28 | Deck pump top cap | 0.4mm Photo Etch | 2 |
| PE-29 | Hatchet | 0.4mm Photo Etch | 6 |
| PE-30 | Euphroe block | 0.4mm Photo-Etch | 2 |
| PE-31 | Nameplate (Alternative) | 0.4mm Photo Etch | 2 |

18' Cutter Master Shipwright Edition 0.4mm Photo Etched Brass

| <u>Pt. No</u> | <u>Description</u> | <u>Material</u> | <u>QTY</u> |
|---------------|---|------------------|------------|
| CPE-1 | 18 Foot Cutter main floor | 0.4mm Photo Etch | 1 |
| CPE-2 | 18 Foot Cutter fore grating | 0.4mm Photo Etch | 1 |
| CPE-3 | 18 Foot Cutter aft grating | 0.4mm Photo Etch | 1 |
| CPE-3 | 18 Foot Cutter aft grating | 0.4mm Photo Etch | 1 |
| CPE-4 | 18 Foot Cutter stern grating | 0.4mm Photo Etch | 1 |
| CPE-5 | 18 Foot Cutter mast strap | 0.4mm Photo Etch | 1 |
| CPE-6 | 18 Foot Cutter rudder side (Left) | 0.4mm Photo Etch | 1 |
| CPE-7 | 18 Foot Cutter rudder side (Right) | 0.4mm Photo Etch | 1 |
| CPE-8 | 18 Foot Cutter small kedge anchor stock | 0.4mm Photo Etch | 2 |
| CPE-9 | 18 Foot Cutter small kedge anchor top | 0.4mm Photo Etch | 2 |
| CPE-10 | 18 Foot Cutter pike shaft | 0.4mm Photo Etch | 2 |
| CPE-11 | 18 Foot Cutter oar | 0.4mm Photo Etch | 6 |

0.6mm Photo Etched Brass

| | | | |
|-------|---|------------------|----|
| PE-32 | Belaying pin | 0.6mm Photo Etch | 50 |
| PE-33 | Small cleat | 0.6mm Photo Etch | 18 |
| PE-34 | Half-Pounder swivel gun handle | 0.6mm Photo Etch | 24 |
| PE-35 | Cathead cleat | 0.6mm Photo Etch | 2 |
| PE-36 | Boarding pike | 0.6mm Photo Etch | 10 |
| PE-37 | Bow 'V' shaped vertical rail (Inner) | 0.6mm Photo Etch | 1 |
| PE-38 | Bow 'V' shaped vertical rail (Middle) | 0.6mm Photo Etch | 1 |
| PE-39 | Bow 'V' shaped vertical rail (Outer) | 0.6mm Photo Etch | 1 |
| PE-40 | Foremast boarding pike/hatchet rack | 0.6mm Photo Etch | 2 |
| PE-41 | Rudder pintle | 0.6mm Photo Etch | 4 |
| PE-42 | Lower stun sail yard inner bracket | 0.6mm Photo Etch | 4 |
| PE-43 | Upper stun sail yard inner bracket | 0.6mm Photo Etch | 4 |
| PE-44 | Anchor ring | 0.6mm Photo Etch | 4 |
| PE-45 | Fore topmast crosstrees | 0.6mm Photo Etch | 1 |
| PE-46 | Main topmast crosstrees | 0.6mm Photo Etch | 1 |
| PE-47 | Stun sail boom outer bracket | 0.6mm Photo Etch | 8 |
| PE-48 | Footrope Stirrup | 0.6mm Photo Etch | 25 |
| PE-49 | Winch drum turning handle | 0.6mm Photo Etch | 2 |
| PE-50 | Lower Top Rail Stanchion | 0.6mm Photo Etch | 8 |
| PE-51 | Dolphin Striker (Not required for 1782 Flirt) | 0.6mm Photo Etch | 1 |

| Pt. No | Description | Fittings | Material | QTY |
|---------------|--|-----------------|-----------------|------------|
| F-1 | Jeer and topsail bitts windlass | | Casting | 1 |
| F-2 | 4 Pounder cannon barrel | | Casting | 14 |
| F-3 | Half-Pounder swivel gun barrel | | Casting | 12 |
| F-4 | 2mm Diameter cannon ball (Stain/paint black) | | Steel | 50 |
| F-5 | Small pin | | 4136/10 | 300 |
| F-6 | 3.5mm Diameter Sheave | | 4280/35 | 10 |
| F-7 | 5mm Deadeye | | 4050/05 | 60 |
| F-8 | 3mm Deadeye | | 4050/03 | 60 |
| F-9 | 2mm Single block | | 4070/02 | 90 |
| F-10 | 3mm Single block | | 4070/03 | 120 |
| F-11 | 5mm Single block | | 4070/05 | 36 |
| F-12 | 4mm Double block | | 4080/04 | 30 |
| F-13 | Parrel bead | | Plastic | 70 |
| F-14 | Large mouse bead (Lower mast stays) | | Plastic | 6 |
| F-15 | Small mouse bead (Upper mast stays) | | Plastic | 6 |

Materials

| | | | | |
|------|--|--|--------------|------|
| F-16 | 0.1mm Diameter natural thread | | DD 50//8243 | 100m |
| F-17 | 0.25mm Diameter natural thread | | DD 36//8243 | 40m |
| F-18 | 0.5mm Diameter natural thread | | DD 25//8243 | 20m |
| F-19 | 0.75mm Diameter natural thread | | DD 50//8243 | 10m |
| F-20 | 0.25mm Diameter black thread | | DD 50//09770 | 20m |
| F-21 | 0.5mm Diameter black thread | | DD 25//09770 | 20m |
| F-22 | 0.75mm Diameter black thread | | DD 18//09770 | 5m |
| F-23 | 1mm Diameter black thread | | DD 12//09770 | 5m |
| F-24 | 1.3mm Diameter black thread | | DD 8//09770 | 20m |
| F-25 | 2mm Diameter natural thread (Anchor hawse) | | DD 36//8243 | 0.5m |
| F-26 | 8mm Dowel x 500mm long | | Wood | 1 |
| F-27 | 6mm Dowel x 500mm long | | Wood | 4 |
| F-28 | 5mm Dowel x 500mm long | | Wood | 4 |
| F-29 | 4mm Dowel x 500mm long | | Wood | 4 |
| F-30 | 3mm Dowel x 500mm long | | Wood | 4 |
| F-31 | 2mm Dowel x 500mm long | | Wood | 2 |
| F-32 | 1.5 x 5 x 500mm long Limewood | | Wood | 30 |
| F-33 | 1 x 4 x 500mm long Second planking | | Wood | 60 |
| F-34 | 1 x 3 x 500mm long Second planking | | Wood | 6 |
| F-35 | 1 x 1 x 500mm long wood strip | | Wood | 2 |
| F-36 | 1mm Diameter brass rod x160mm long (Approx.) | | Metal | 1 |
| F-37 | 0.5mm Diameter brass rod x 160mm long (Approx.) | | Metal | 1 |
| F-38 | Black Cartridge paper (For anchor & mast straps) | | Paper | 1 |

Laser and PE Sheet Quantities

| Pt. No | Description | Material | QTY |
|---------------|--------------------------------|-----------------|------------|
| | 3mm MDF Laser Cut | | 2 |
| | 2mm MDF Laser cut (Anchors) | | 1 |
| | 2mm Ceiba Plywood | | 1 |
| | 2mm Birch Plywood | | 1 |
| | 2mm Clear Acetate | | 1 |
| | 1mm Pear Wood | | 2 |
| | 1.5mm Pear Wood | | 1 |
| | 2mm Pear Wood | | 1 |
| | 3mm Pear Wood | | 1 |
| | 4mm Pear Wood | | 1 |
| | 0.8mm Plywood | | 2 |
| | 1mm Wood laser etched deck | | 1 |
| | 0.2mm Photo Etched Brass Sheet | | 1 |
| | 0.4mm Photo Etched Brass Sheet | | 1 |
| | 0.6mm Photo Etched Brass Sheet | | 1 |

Optional Ships Boat

| | | | |
|-----|--------------------------------|--|----|
| | 0.4mm Photo Etched Brass Sheet | | 1 |
| | 2mm Plywood | | 1 |
| | 1mm Pear Wood | | 1 |
| C23 | 1x2x100mm Pear Wood Strip | | 24 |

Master Shipwright Laser and PE Sheet Quantities

| | | | |
|------------------------------------|-------------------------------|------|----|
| 3mm Birch Plywood Laser Cut | | | 2 |
| 2mm MDF Laser cut (Anchors) | | | 1 |
| 2mm Birch Plywood | | | 1 |
| 2mm Clear Acetate | | | 1 |
| 1mm Boxwood | | | 2 |
| 1.5mm Boxwood | | | 1 |
| 2mm Boxwood | | | 1 |
| 3mm Boxwood | | | 1 |
| 4mm Boxwood | | | 1 |
| 0.8mm Plywood | | | 2 |
| 1mm Maple Veneer laser etched deck | | | 1 |
| 1mm Pear Wood Heart Blocks | | | 1 |
| 0.2mm Photo Etched Brass Sheet | | | 1 |
| 0.4mm Photo Etched Brass Sheet | | | 2 |
| 0.6mm Photo Etched Brass Sheet | | | 1 |
| F-32 | 1.5 x 5 x 500mm long Limewood | Wood | 30 |
| F-33 | 1 x 4 x 500mm long Boxwood | Wood | 60 |
| F-34 | 1 x 3 x 500mm long Boxwood | Wood | 6 |
| F-35 | 1 x 1 x 500mm long wood strip | Wood | 2 |
| C23 | 1x2x100mm Pear Wood Strip | Wood | 20 |

VANGUARD MODELS

BY CHRIS WATTON

©Vanguard Models is a subsidiary of Burncroft Limited

Registered Office:

70B, High Street

Cinderford

Gloucestershire

GL14 2SZ

UK

Tel (0044) [0]1594 824610

Registered company number – 04317996

Website - www.vanguardmodels.co.uk

Email - sales@vanguardmodels.com

HMS Flirt was designed and developed in the UK by Chris Watton

Finished prototype model made and photographed (including construction manual text) by James Hatch

13/06/2020