

Proxima

Best.Nr.: 2207

Bauanleitung Assembly Instructions Notice de montage Istruzioni di montaggio Instrucciones de montaje

Erforderliche Materialien für den Zusammenbau

Required materials for assembly
Matériaux nécessaires à l'assemblage
Materiali richiesti per il montaggio
Materiales necesarios para el montaje

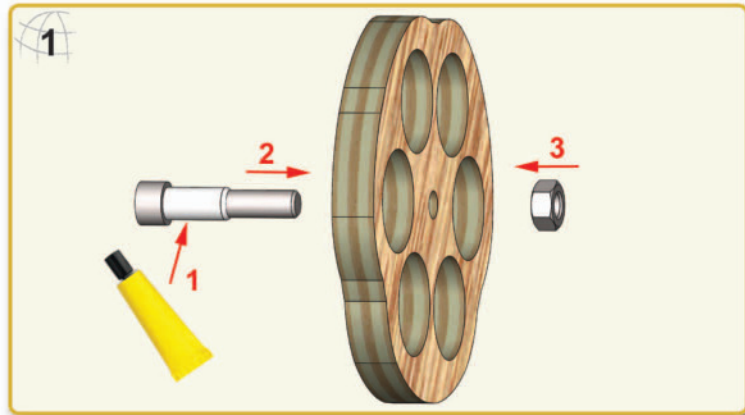

 Etwas Klebstoff (Epoxidharz) auf die Schraube auftragen und durch das Loch des hinteren Motorspant stecken. Mutter anschrauben und fest anziehen.

 Apply some epoxy glue to the screw and push it through the hole of the aft motor bulkhead. Screw on nut and tighten.

 Appliquer de la colle époxy sur la vis et la glisser à travers le trou de la cloison arrière du support-moteur. Vissez l'écrou et serrez.

 Aplique un poco de pegamento epoxi al tornillo y empújelo a través del orificio del mamparo del motor de popa. Atornille la tuerca y apriete.

 Applicare della colla epossidica sulla vite e spingerla attraverso i foro della paratia posteriore del supporto motore. Avvitare il dado e serrare.

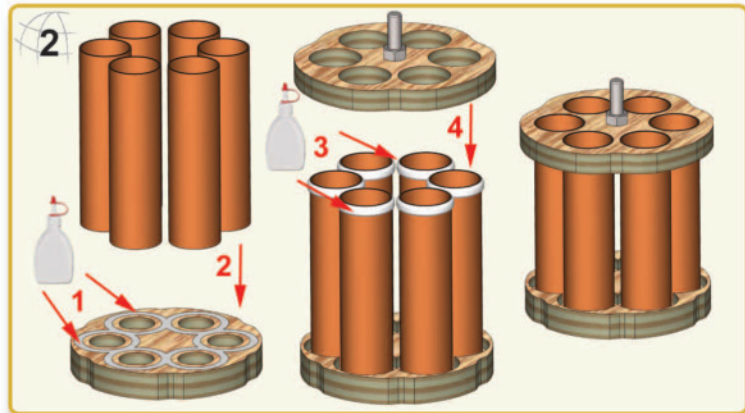

 Am vorderen Motorspant wie abgebildet Klebstoff (Holzleim) auftragen und Motorrohre aufstecken. Am hinteren Ende der Motorrohre umlaufend Klebstoff auftragen und den hinteren Spant ankleben. Der Spant sollte bündig mit diesen sein, bzw. sollten die Motorrohre maximal 3mm überstehen. Anschließend von beiden Seiten eine umlaufende Klebstoff-Raupe anbringen und zum Trocknen beiseitelegen.

 Apply some wood glue to the front bulkhead as pictured and insert the motor tubes. Then apply some beads of wood glue at the rear ends of the motor tubes and glue on the rear bulkhead. The bulkhead should either be flush with the tubes should only stick out by no more than 3mm. The apply some fillets of wood glue to all joints and set aside to dry.

 Appliquer de la colle à bois sur la cloison avant comme illustré et insérer les tubes support-moteur. Ensuite, appliquer des cordons de colle à bois aux extrémités arrière des tubes support-moteur et sur la cloison arrière. La cloison doit être alignée avec les tubes, mais ne doit être enfoncée de plus de 3 mm. Appliquer des filets de colle de bois sur tous les joints et laisser sécher.

 Aplique un poco de pegamento de madera al mamparo delantero como se ilustra e inserte los tubos del motor. A continuación, aplique algunas perlas de pegamento de madera en los extremos traseros de los tubos del motor y cola en el mamparo trasero. El mamparo debe estar al ras con los tubos debe sobresalir por no más de 3 mm. La aplicación de algunos filetes de pegamento de madera a todas las articulaciones y dejar a un lado para secar.

 Applicare un po' di colla per legno alla paratia anteriore del supporto motore come illustrato nel disegno e inserire i tubi portamotori. Quindi applicare uno strato di colla di legno sulle estremità posteriori dei tubi motore ed incollare la paratia posteriore. La paratia può essere a filo con i tubi oppure questi possono sporgere per 3 mm al massimo. Applicare filetti di colla per legno lungo tutte le giunture e mettere da parte ad asciugare.

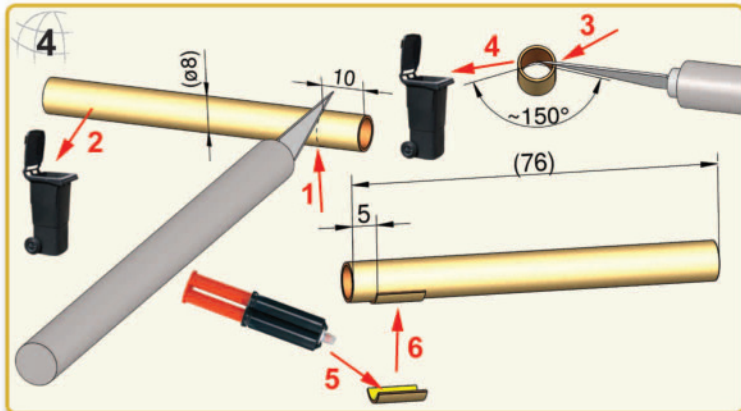

 Bei einem der beiden Leitrohrchen ein ca. 1 cm langes Stück abschneiden und wie dargestellt zerteilen. Das kleinere Teil wird wie abgebildet auf dem übrigen Leitrohr als Abstandhalter angeklebt.

 Cut off 1 cm from one of the supplied launch lugs and slice that section as shown. The smaller section is to be glued as pictured to the remaining launch lug as a spacer.

 Couper 1 cm de l'un des tubes de guidage fournis et découper cette section comme indiqué. La section plus petite doit être collée comme représenté sur la tube de guidage restant comme écarteur.

 Corte 1 cm de una de las lengüetas de lanzamiento suministradas y corte esa sección como se muestra. La sección más pequeña debe pegarse como se representa en la lengüeta de lanzamiento restante como un espaciador.

 Tagliare 1 cm da una delle guide di lancio fornite (tubetto in cartone) e ricavare una parte come mostrato. Questa parte più piccola deve essere incollata sul tubetto come descritto e serve come distanziatore.

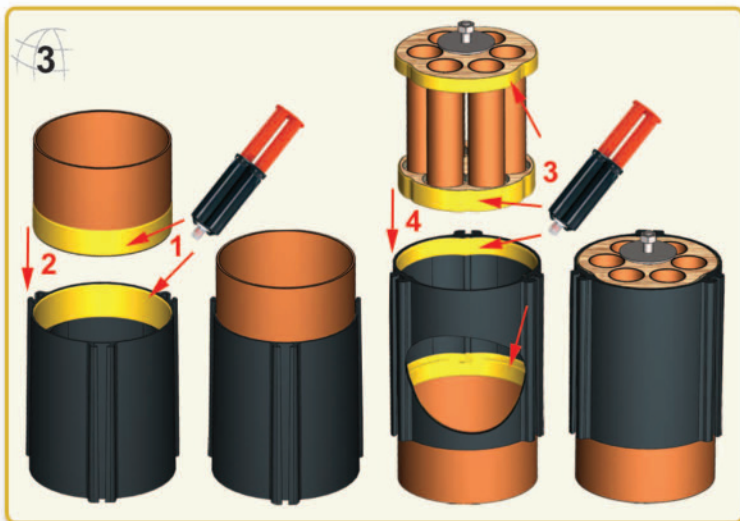

 Vor dem Einkleben empfiehlt es sich die Klebeflächen am Kunststoff mit Schleifpapier anzurauen. Einen der kurzen Kuppler wie dargestellt mit Epoxidharzkleber in das Heckteil einkleben. Die fertige Motorhalterung in das Heckteil einkleben. Der hintere Spant und das Heckteil sollten miteinander bündig sein.

 Before applying epoxy glue it is recommended to roughen the plastic surfaces with sandpaper. Attach one of the short coupler tubes in to the fin can as shown. Glue the assembled motor mount in to the fin can with epoxy glue. The rear bulkhead and the fin can should be flush to each other.

 Avant d'appliquer la colle époxy, il est conseillé de dépolir les surfaces plastique avec du papier abrasif. Fixez l'un des tubes courts du coupleur au tube porte-aillettes comme indiqué. Collez le montage du moteur assemblé dans le tube de porte-aillettes avec de la colle époxy. La cloison arrière et la boîte à ailettes doivent être alignées l'une sur l'autre.

 Antes de aplicar pegamento epoxi se recomienda para áspero las superficies de plástico con papel de lija. Conecte uno de los tubos acopladores corto a la lata como se muestra. Pegue el montaje del motor montado en la lata de aleta con pegamento epoxi. El mamparo trasero y la lata de aleta deben estar al ras el uno del otro.

 Prima di applicare la colla si raccomanda di irruvidire le superfici in plastica con carta vetrata. Fissare uno dei tubi di coppia corto alla blocco di supporto delle alette come illustrato. Incollare il montaggio del motore assemblato nella blocco di supporto delle alette con colla epossidica. La paratia posteriore e le blocco di supporto delle alette dovrebbe essere rivolte a vicenda.

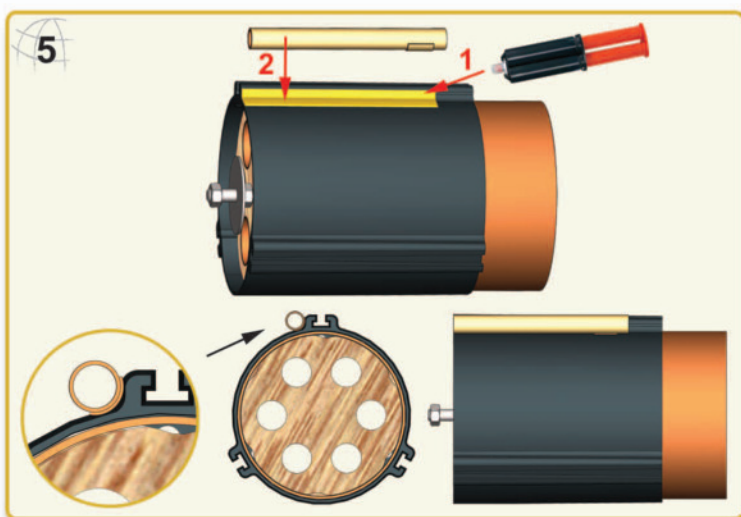

 Das vorbereitete Leitrohr kann nun mit Epoxidharz an eine Seite der Flossen-Führungen angeklebt werden. Die Fugen zwischen Leitrohr und Kunststoff sollten mit Epoxidharz glattgestrichen werden. Zuvor sollte die Kunststoff-Oberfläche wieder angeraut werden.

 The prepared launch lug can now be glued to the side of one of the fin slots with epoxy glue. The space between the launch lug and the fin can are to be filleted with epoxy as well for maximum strength. Before applying glue the plastic surfaces should be roughened up a bit.

 Le tube de guidage préparé peut maintenant être collé sur le côté d'une des fentes d'aillettes avec de la colle époxy. L'espace entre la patte de lancement et l'aillette peut être comblé avec de l'époxy pour une résistance maximale. Avant d'appliquer de la colle, les surfaces plastique doivent être rendues légèrement rugueuses.

 La lengüeta de lanzamiento preparada ahora se puede pegar al lado de una de las ranuras de la aleta con el pegamento epoxy. El espacio entre la lengüeta de lanzamiento y la lata de aleta debe ser fileteado con epoxi, así como la máxima resistencia. Antes de aplicar pegamento, las superficies de plástico deben estar rugosas un poco.

 La guida di lancio appena preparata può ora essere incollata sul supporto delle alette, al lato di una delle feritoie nelle quali si inseriranno le alette, usando colla epossidica. La giunzione tra la guida di lancio e il supporto delle alette deve essere raccordata con colla epossidica per garantire la massima resistenza. Prima di applicare la colla sulle superfici in plastica, irruvidirle con carta abrasiva.

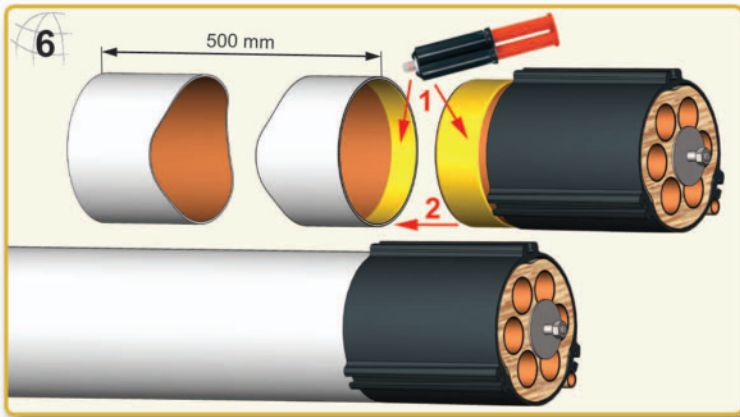

 Im langen Körperrohr (500 mm Länge) in einer Seite eine umlaufende Klebstoff-Raupe anbringen (Epoxy) und das Heckteil einkleben.

 Apply a bead of epoxy glue to the inside of one end of the larger body tube (500 mm long) and glue in the fin can as pictured.

 Appliquer un cordon de colle époxy à l'intérieur d'une extrémité du tube le plus grand formant le corps de la fusée (500 mm de long) et de la colle dans la cannelure de l'ailette comme illustré.

 Aplique un cordón de cola epoxy en el interior de un extremo del tubo de cuerpo más grande (500 mm de largo) y pegamento en la lata de aleta como se ilustra.

 Applicare uno strato di colla epossidica all'interno di un'estremità del tubo fusoliera più grande (lunghezza 500 mm) ed incollate il blocco di supporto delle alette come illustrato.

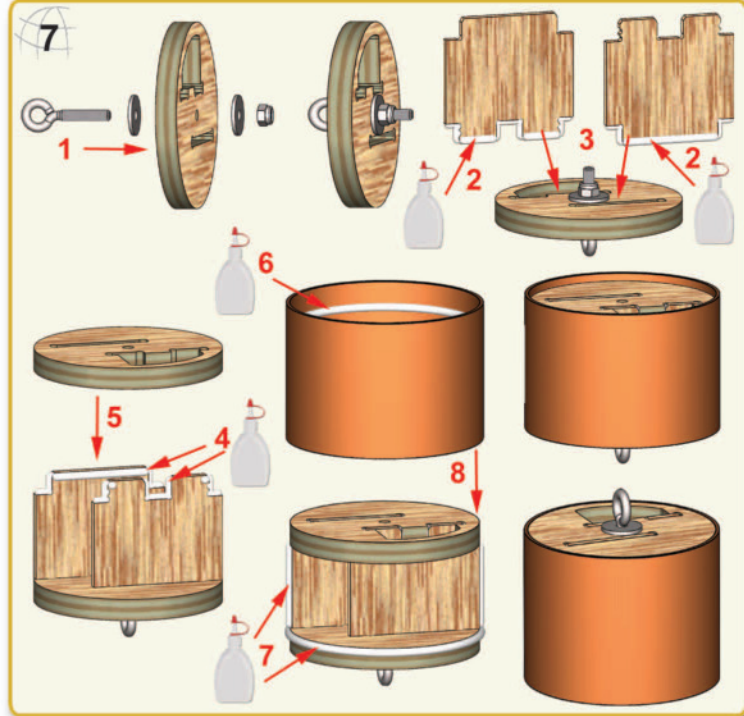

 Den Fallschirmschutz wie abgebildet montieren und kleben. Auf die richtige Reihenfolge der dargestellten Schritte achten! Ebenfalls ist ein kurzer Kuppler hierfür zu verwenden.

 Assemble and glue the deflector as pictured. Pay attention to the correct order of the displayed assembly steps! Use the other short coupler tube for this component.

 Assemblez et collez le déflecteur comme sur la photo. Faites attention à l'ordre correct des étapes d'assemblage affichées! Utilisez l'autre tube de couplage court pour ce composant.

 Ensamble y pegue el deflector como se muestra en la imagen. ¡Preste atención al orden correcto de los pasos de montaje mostrados! Use el otro tubo corto de acoplamiento para este componente.

 Montare e incollare il deflettore come illustrato. Prestare attenzione all'ordine corretto dei punti di montaggio visualizzati! Utilizzare l'altro tubo di accoppiamento corto per questo componente.

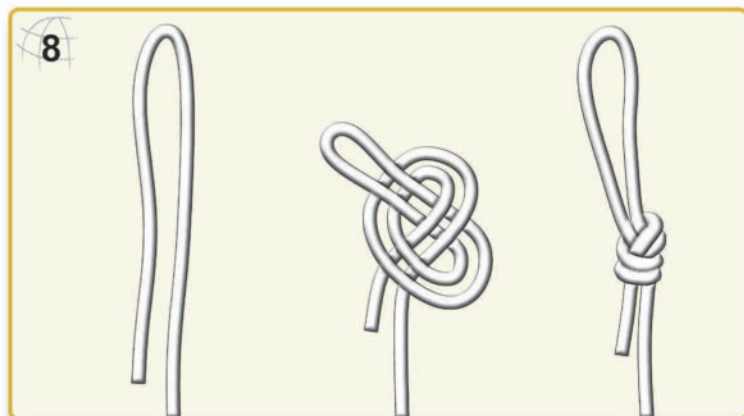

 In die weiße Schnur eine Schlaufe binden.

 Tie a noose on one end of the white cord.

 Effectuer un nœud en queue de vache à une extrémité du cordon blanc.

 Ate un nudo en un extremo del cordón blanco.

 Formate un cappio ad un'estremità del cavo bianco.

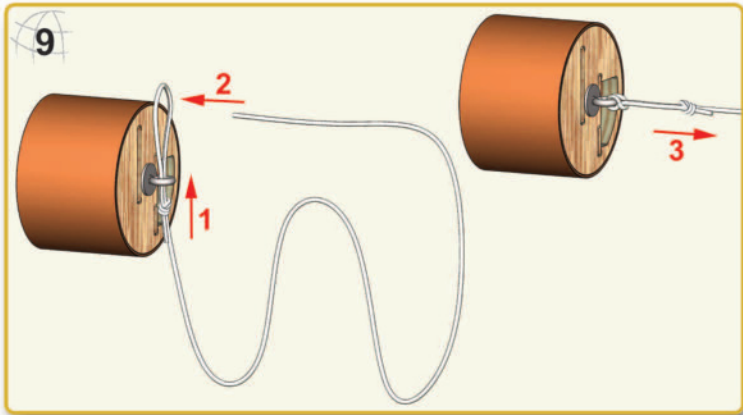

Germany Die Schlaufe mit einem Ankerstich an die Öse des Fallschirmschutzes befestigen.

United Kingdom Attach the noose to the baffle with a cow hitch as pictured.

France Passer la boucle dans le trou du déflecteur puis glisser l'extrémité du cordon dedans pour fermer le nœud comme indiqué.

Spain Fije el lazo al deflector con un enganche de vaca como se ilustra.

Italy Fissate il cappio nel foro del deflettore con un nodo, come nella immagine.

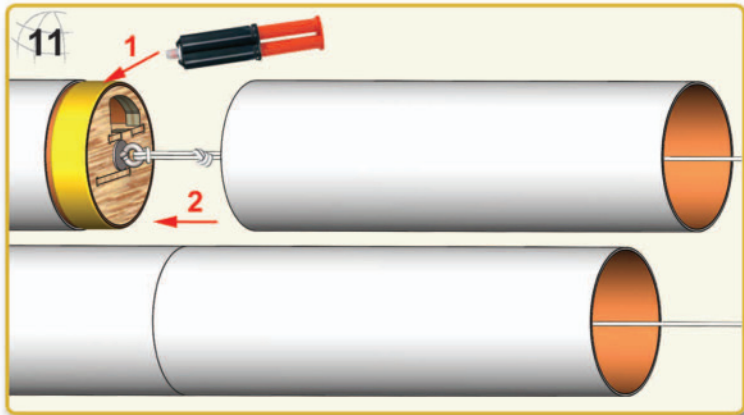

Germany Nun das obere (kürzere) Rohr mit Klebstoff befestigen. Darauf achten dass die Körperrohre gut aufeinander sitzen.

United Kingdom Now attach the upper (shorter) tube with glue. Be sure the tubes are seated well to each other.

France Fixez maintenant le tube supérieur (plus court) avec de la colle. Assurez-vous que les tubes sont bien placés les uns aux autres.

Spain Ahora conecte el tubo superior (más corto) con pegamento. Asegúrese de que los tubos estén bien unidos entre sí.

Italy Ora fissare il tubo superiore (più corto) con colla. Assicurarsi che i tubi siano ben seduti l'uno all'altro.

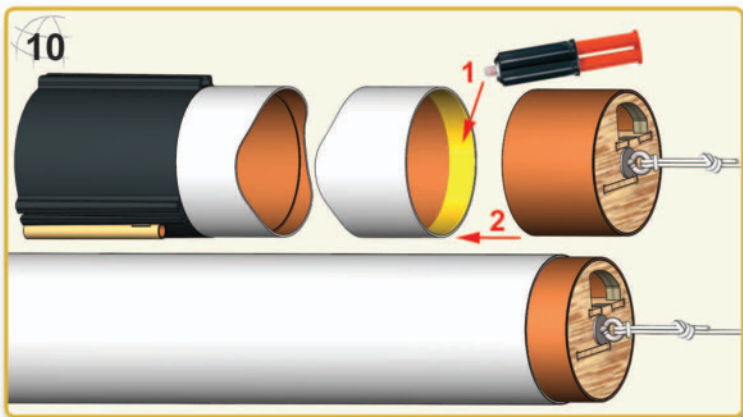

Germany Den fertigen Fallschirmschutz im unteren Körperrohr wie abgebildet einkleben, jedoch nur zur Hälfte einschieben.

United Kingdom Now glue the completed baffle in to the lower body tube as pictured, but leave half of it sticking out.

France Maintenant, coller le déflecteur complet dans le tube inférieur de la fusée comme sur la photo, mais laisser la moitié de celui-ci dépasser.

Spain Ahora pegue el deflector completado en el tubo del cuerpo inferior como se ilustra, pero deje la mitad de él sobresaliendo.

Italy Ora incollare il deflettore completato al tubo inferiore del corpo del razzo come illustrato, lasciandone sporgere metà.

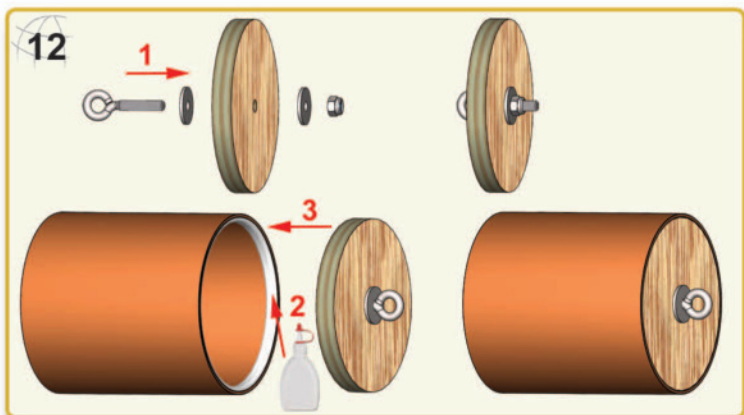

Germany Wie abgebildet, die Ösenschraube mit dem Spant montieren und in den verbleibenden Rohrverbinder einkleben.





United Kingdom As pictured, mount the eyebolt with the bulkhead and glue the assembled bulkhead into the remaining tube connector.

France Comme sur la photo, montez l'œillet avec la cloison et collez la cloison assemblée dans le connecteur du tube restant.

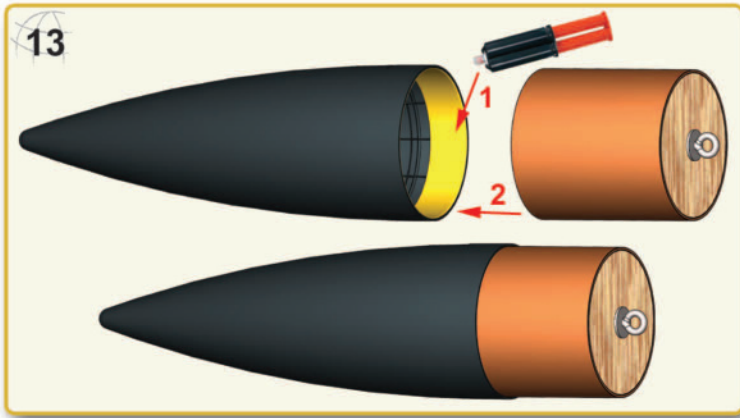



Spain Como se muestra, monte el cáncamo con el mamparo y pegue el mamparo ensamblado en el conector restante del tubo.

Italy Come illustrato, montare il golfare con la paratia e incollare la paratia assemblato per la restante coppia.

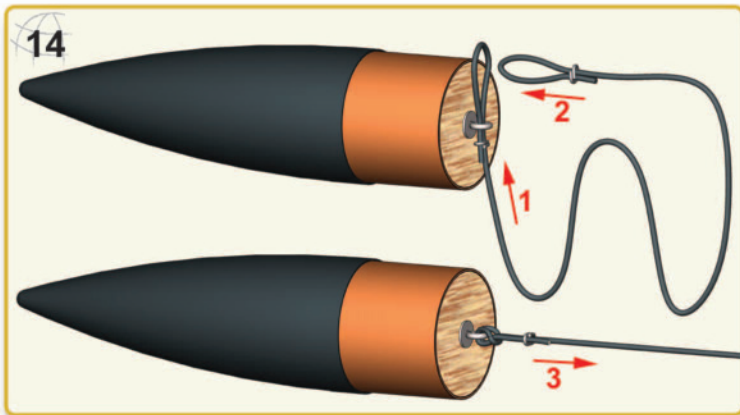





-  Dann den fertigen Kuppler mit Epoxy in die Spitze einkleben.
-  Then glue the finished coupler into the nose cone with epoxy.
-  Ensuite, collez le coupleur fini dans l'ogive avec de colle époxy.
-  Luego pegue el acoplador terminado en la ojiva con epoxy.
-  Quindi incollare il tubo accoppiatore finito nel l'ogiva con colla epossidica.

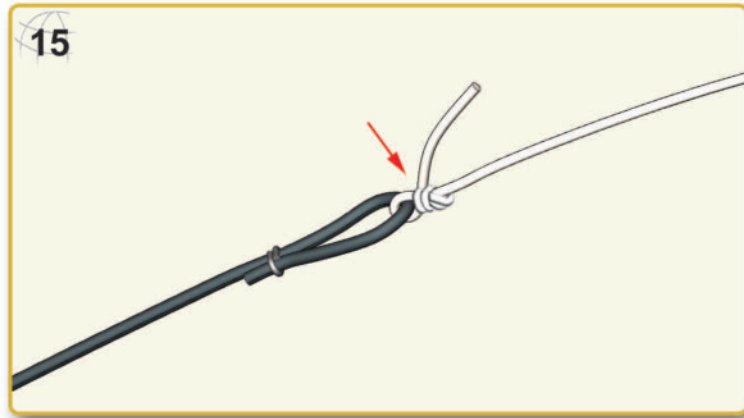





-  Das Gummiseil wie dargestellt an der Spitze befestigen.
-  Attach the elastic shock cord to the nose cone as pictured.
-  Fixez le cordon amortisseur élastique sur l'ogive comme indiqué.
-  Conecte el cordón de choque elástico al cono de la nariz como se ilustra.
-  Legate il cavo elastico all'ogiva come illustrato.

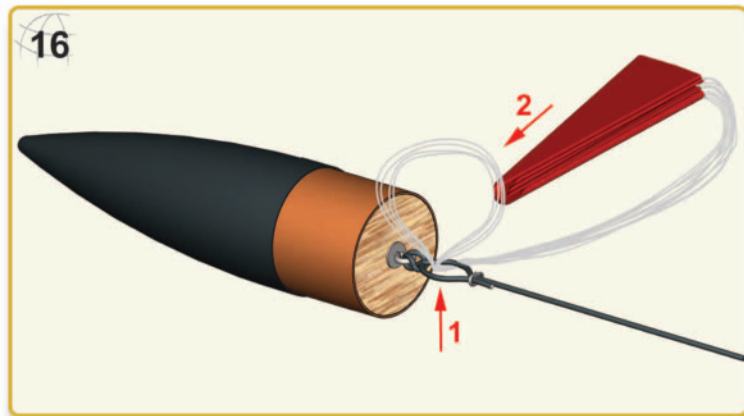

-  Weiße Schnur und Gummiseil an einander festknoten.
-  Tie the white cord and elastic cord together.
-  Attacher le cordon blanc et le cordon élastique ensemble.
-  Ate el cordón blanco y el cordón elástico juntos.
-  Legare il cavo bianco e il cavo elastico insieme.



-  Fädeln Sie die Schlaufen der Fallschirmleinen durch die Schlaufe des Gummiseils und ziehen Sie durch diese gemeinsame Schlaufe den Fallschirms hindurch. Die Leinen sollten etwa gleich lang sein.
-  Pass the shroud line loops of the pre-sewn parachute through the eyelet of the elastic cord. Pass parachute through the loop ends and pull lines tightly against the eyelet.
-  Passer les boucles des suspentes du parachute pré-cousu à travers l'œillet du cordon élastique. Glisser le parachute à travers les extrémités de la boucle et tirer les lignes fermement contre l'œillet.
-  Pase los bucles de la línea de protección del paracaídas precosido a través del ojal del cordón elástico. Pase el paracaídas a través de los extremos del bucle y tire de las líneas firmemente contra el ojal.
-  Passare le funicelle pre-cucite del paracadute attraverso l'occhiello dell'ogiva, dove è legato il cavo elastico. Passare il paracadute attraverso l'asola formata dalle funicelle e tirarle strettamente contro l'occhiello dell'ogiva.

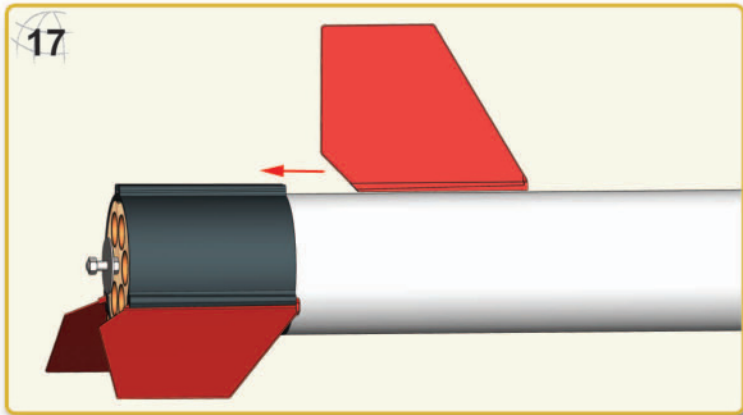

Germany Die Flossen entsprechend der konischen Führung bis zum Anschlag in die Nuten des Heckteils stecken. Klebstoff wird nicht benötigt.

United Kingdom Slide the fins in to the V-shaped grooves of the fin can accordingly until they reach the stop. Glue is not required.

France Faire glisser les ailettes dans les rainures en forme de V jusqu'à ce qu'elles atteignent la butée. De la colle n'est pas nécessaire.

Spain Deslice las aletas hacia los surcos en forma de V de la aleta hasta que lleguen al tope. No se requiere pegamento.

Italy Inserire le alette nelle scanalature del supporto alette fino in fondo. Non è necessario incollare.

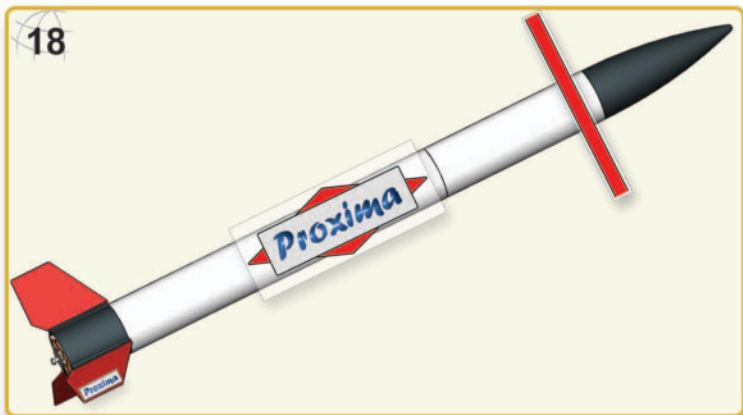

Germany Die Aufkleber gemäß Abbildung anbringen. Eventuelle Luftblasen von innen nach außen streichen.

United Kingdom Apply stickers as shown on picture. Smooth out air bubbles from center to edge.

France Appliquer des autocollants comme indiqué sur la photo. Lisser les bulles d'air centre vers le bord.

Spain Aplicar pegatinas como se muestra en la foto. Suavice las burbujas de aire del centro al borde.

Italy Applicare le decal adesive come mostrato in figura. Eliminate le bolle d'aria premendo dal centro verso i bordi della decal.

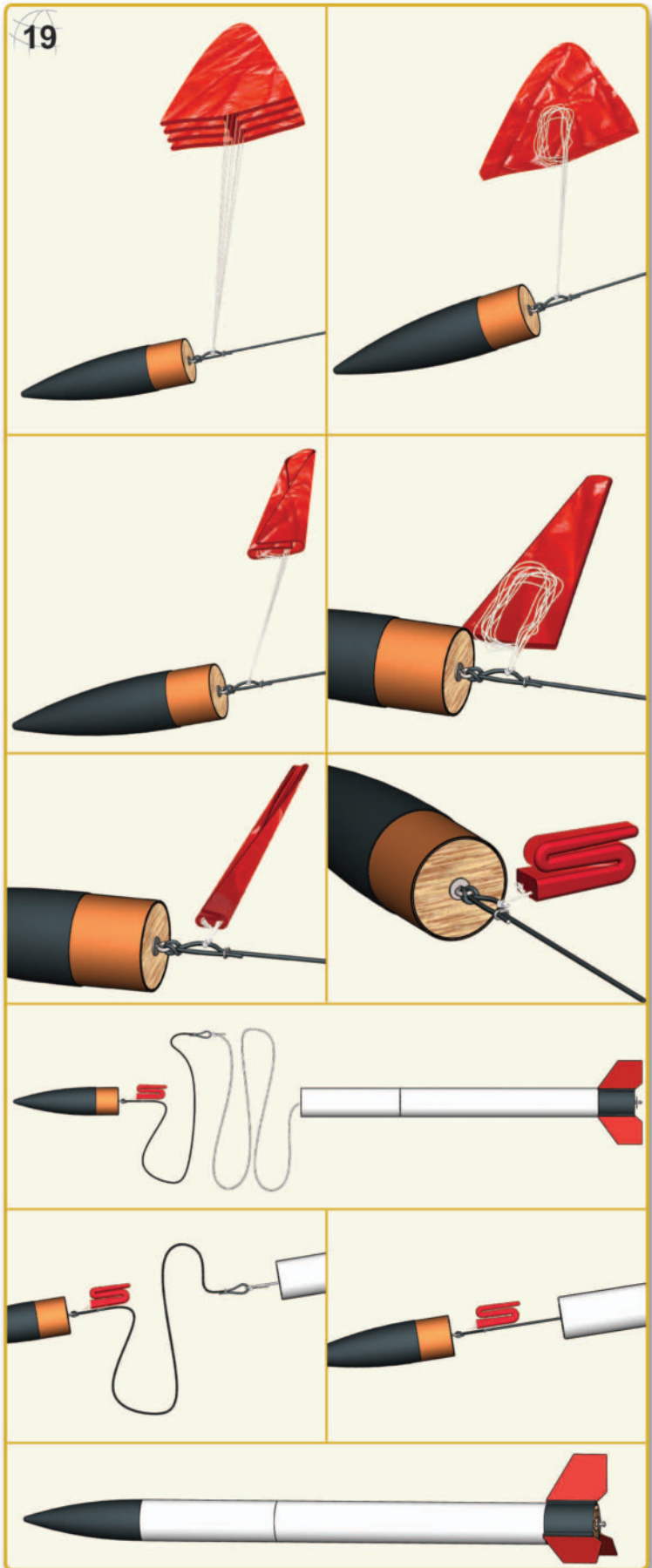

Germany Den Fallschirm gemäß der abgebildeten Schritte zusammenpacken.

United Kingdom Fold and pack the parachute according to the displayed steps.

France Pliez et emballez le parachute comme les étapes affichées.

Spain Doblar y embalar el paracaídas de acuerdo con los pasos que se muestran.

Italy Piegate e imballare il paracadute insieme come le istruzioni illustrate.