

Aermacchi MB-339 60–86N Military

Almost-Ready-To-Fly

HANGAR 9®

Instruction Manual
Bedienungsanleitung
Manuel d'utilisation
Manuale di Istruzioni



ARF



HAN3390B

Scan the QR code and select the Manuals and Support quick links from the product page for the most up-to-date manual information.

Scannen Sie den QR-Code und wählen Sie auf der Produktseite die Quicklinks Handbücher und Unterstützung, um die aktuellsten Informationen zu Handbücher.

Scannez le code QR et sélectionnez les liens rapides Manuals and Support sur la page du produit pour obtenir les informations les plus récentes sur le manuel.

Scannerizzare il codice QR e selezionare i Link veloci Manuali e Supporto dalla pagina del prodotto per le informazioni manuali più aggiornate.

Updated 04/2024

HORIZON
H O B B Y

NOTICE

All instructions, warranties and other collateral documents are subject to change at the sole discretion of Horizon Hobby, LLC. For up-to-date product literature, visit horizonhobby.com or towerhobbies.com and click on the support or resources tab for this product.

MEANING OF SPECIAL LANGUAGE

The following terms are used throughout the product literature to indicate various levels of potential harm when operating this product:

WARNING: Procedures, which if not properly followed, create the probability of property damage, collateral damage, and serious injury OR create a high probability of superficial injury.

CAUTION: Procedures, which if not properly followed, create the probability of physical property damage AND a possibility of serious injury.

NOTICE: Procedures, which if not properly followed, create a possibility of physical property damage AND a little or no possibility of injury.



WARNING: Read the ENTIRE instruction manual to become familiar with the features of the product before operating. Failure to operate the product correctly can result in damage to the product, personal property and cause serious injury.

This is a sophisticated hobby product. It must be operated with caution and common sense and requires some basic mechanical ability. Failure to operate this Product in a safe and responsible manner could result in injury or damage to the product or other property. This product is not intended for use by children without direct adult supervision. Do not attempt disassembly, use with incompatible components or augment product in any way without the approval of Horizon Hobby, LLC. This manual contains instructions for safety, operation and maintenance. It is essential to read and follow all the instructions and warnings in the manual, prior to assembly, setup or use, in order to operate correctly and avoid damage or serious injury.

Age Recommendation: Not For Children Under 14 Years. This Is Not A Toy.

SAFETY WARNINGS AND PRECAUTIONS

Read and follow all instructions and safety precautions before use. Improper use can result in fire, serious injury and damage to property.

Components

Use only with compatible components. Should any compatibility questions exist, please refer to the product instructions, component instructions or contact the appropriate Horizon Hobby office.

Flight

Fly only in open areas to ensure safety. It is recommended flying be done at radio control flying fields. Consult local ordinances before choosing a flying location.

Batteries

Always follow the manufacturer's instructions when using and disposing of any batteries. Mishandling of Li-Po batteries can result in fire causing serious injury and damage.

Turbine Safety

Follow any turbine safety procedures as outlined in the manual for your particular turbine. Additional details can be found at the AMA website. (<https://www.modelaircraft.org/system/files/documents/510-A.pdf>)

Small Parts

This kit includes small parts and should not be left unattended near children as choking and serious injury could result.

SAFE OPERATING RECOMMENDATIONS

- Inspect your model before every flight to ensure it is airworthy.
- Be aware of any other radio frequency user who may present an interference problem.
- Always be courteous and respectful of other users in your selected flight area.
- Choose an area clear of obstacles and large enough to safely accommodate your flying activity.
- Make sure this area is clear of friends and spectators prior to launching your aircraft.
- Be aware of other activities in the vicinity of your flight path that could cause potential conflict.
- Carefully plan your flight path prior to launch.
- Abide by any and all established AMA National Model Aircraft Safety Code.

BEFORE STARTING ASSEMBLY

- Remove parts from bag.
- Inspect fuselage, wing panels, rudder and stabilizer for damage.
- If you find damaged or missing parts, contact your place of purchase.
- Charge transmitter and receiver batteries.
- Center trims and sticks on your transmitter.
- For a computer radio, create a model memory for this particular model.
- Bind your transmitter and receiver, using your radio system's instructions.

NOTICE: Rebind the radio system once all control throws are set. This will keep the servos from moving to their endpoints until the transmitter and receiver connect. It will also guarantee the servo reversal settings are saved in the radio system.

IMPORTANT FEDERAL AVIATION ADMINISTRATION (FAA) INFORMATION



Use the QR code below to learn more about the **Recreational UAS Safety Test (TRUST)**, as was introduced by the 2018 FAA Reauthorization Bill. This free test is required by the FAA for all recreational flyers in the United States. The completed certificate must be presented upon request by any FAA or law enforcement official.



If your model aircraft weighs more than .55lbs or 250 grams, you are required by the FAA to register as a recreational flyer and apply your registration number to the outside of your aircraft. To learn more about registering with the FAA, use the QR code below.

IMAGES WITHIN THE MANUAL

The trim scheme and colors shown in this manual have been updated. Refer to the website product pages for the most up-to-date information.

TABLE OF CONTENTS

Notice.....	2
Meaning of Special Language.....	2
Safety Warnings and Precautions.....	2
Safe Operating Recommendations.....	2
Before Starting Assembly.....	2
Important Federal Aviation Administration (FAA) Information.....	2
Images within the manual.....	2
Replacement Parts.....	3
Required for Completion.....	4
Tools Required.....	4
Required Adhesives.....	4
Building Precautions.....	4
Transportation and Storage.....	4
Checking Blind Nuts.....	4
Printed Covering Notes.....	4
Flap Hinging.....	5
Aileron Control Horn and Hinging.....	6
Aileron Servo Installation.....	7
Flap Servo Installation.....	9
Elevator Hinging.....	12
Rudder Hinging.....	12
Rudder Servo Installation.....	12
Elevator Servo Installation.....	13
Main Retract Installation.....	13
Nose Gear Retract Installation.....	14
Battery, Receiver and Retract Module Installation.....	14
Fuel Tank Assembly.....	15
Elevator and Rudder Extension Installation.....	17
Turbine Installation.....	17
Fin Installation.....	18
Stabilizer Installation.....	18
Joining the Fuselage.....	19
Wing Installation.....	19
Intake Installation.....	20
Scale Accessories.....	20
Center of Gravity.....	21
Nose weight.....	21
Control Throws.....	21
Mixing.....	22
Preflight Checklist.....	22
Daily Flight Checks.....	22
Limited Warranty.....	22
Warranty and Service Contact Information.....	23
Instructions for Disposal of WEEE by Users in the European Union.....	23
Academy of Model Aeronautics National Model Aircraft Safety Code.....	24
Building Notes.....	24

REPLACEMENT PARTS

Item #	Description
HAN339001B	Fuselage: Aermacchi MB-339 60-86N; Military
HAN339002B	Wing Set: Aermacchi MB-339 60-86N; Military
HAN339003B	Fin and Rudder: Aermacchi MB-339 60-86N; Military
HAN339004B	Stabilizer and Elevators: Aermacchi MB-339 60-86N; Military
HAN339005	Retract Set: Aermacchi MB-339 60-86N
HAN339006	Retract Controller: Aermacchi MB-339 60-86N
HAN339007B	Canopy Hatch with Cockpit: Aermacchi MB-339 60-86N; Military
HAN339008B	Canopy Only: Aermacchi MB-339 60-86N; Military
HAN339009	Joiner Tube Set: Aermacchi MB-339 60-86N
HAN339010B	Air Intake Set: Aermacchi MB-339 60-86N; Military
HAN339011B	Tip Tank Set: Aermacchi MB-339 60-86N; Military
HAN339012	Stainless Tailpipe: Aermacchi MB-339 60-86N
HAN339013	Fuel Tank: Aermacchi MB-339 60-86N
HAN339014B	Hardware Set: Aermacchi MB-339 60-86N; Military
HAN339015	Retract Motor: Aermacchi MB-339 60-86N
HAN339016	Nose Wheel; 65mm: Aermacchi MB-339 60-86N
HAN339017	Main Wheel w/ Brake; 65mm (1): Aermacchi MB-339 60-86N
HAN339018	Main Struts (2): Aermacchi MB-339 60-86N; Sport
HAN339020B	Fuselage Hatch, Upper: Aermacchi MB-339 60-86N; Military
HAN339021B	Fuselage Hatch, Lower: Aermacchi MB-339 60-86N; Military
HAN339022	Main Tire Set (2): Aermacchi MB-339 60-86N
HAN339023B	Ventral Fin Set: Aermacchi MB-339 60-86N; Military
HAN339024B	Decal Sheet: Aermacchi MB-339 60-86N; Military
HAN339026	Spring Shaft: Aermacchi MB-339 60-86N
HAN339029	Retract Set: Aermacchi MB-339 60-86N; Military
HAN339030	Main Gear Retract Unit: Aermacchi MB-339 60-86N; Military
HAN339031	Nose Gear Retract Unit: Aermacchi MB-339 60-86N
HAN339031	Nose Gear Retract Unit: Aermacchi MB-339 60-86N; Military
HAN339032	Nose Strut Pivot Shaft: Aermacchi MB-339 60-85N; Military
HAN339033	Nose Gear Strut: Aermacchi MB-339 60-85N; Military
HAN339034	Main Gear Strut Set: Aermacchi MB-339 60-85N; Military

REQUIRED FOR COMPLETION

# Required	Item #	Description
1	DUB674	Super Strength Standard Servo Arms: JR
1	DUB675	Super Strength Standard Servo Arms: HRC
2	SPMA3002	Heavy-Duty Servo Extension 9-inch
1	SPMA3003	Heavy-Duty Servo Extension 12-inch
9	SPMA3004	Heavy-Duty Servo Extension 18-inch
3	SPMA3007	Heavy-Duty Servo Extension 48-inch
1	SPMAR14400T	AR14400T 14 Channel PowerSafe Telemetry Receiver
4	SPMSA5080	A5080 MT/HS Mini Digital HV Servo (elevators, rudder and nose steering)
4	SPMSA6320	A6320 H-T/H-S Brushless HV Servo (ailerons and flaps)
3	SPMX20002SRX	7.4V 2000mAh 2S 15C Smart LiPo Receiver Battery: Universal Receiver, IC3(Receiver x2 and Retracts x1)
1	SPMX32003SLFRX	9.9V 3200mAh 3S 15C Smart LiFe ECU Battery: Universal Receiver, IC3 (Turbine)
1		60-86N Turbine
1	KGTU150	Air Trap
1	HAN116	Fuel Filler with "T" Fitting and Overflow Fitting

TOOLS REQUIRED

Description
Drill and tap set, metric
Drill bit set, Imperial or Metric
Epoxy brushes
Felt-tipped pen
Hemostats
Hex wrench set, Imperial and Metric
Hobby knife with #11 blade
Hook and loop straps
Hook and loop tape
Isopropyl alcohol
Low-tack tape
Mixing sticks
Needle nose pliers
Nut driver set, Imperial and Metric
Paper towels
Pencil
Petroleum jelly
Phillips screwdriver: #1, #2
Pin vise
Ruler
Sandpaper
Scissors

TOOLS REQUIRED

Description
Side cutters
Square
Tap handle
Tie wraps
Toothpicks
Wire stripper

REQUIRED ADHESIVES

Description
15-minute epoxy
30-minute epoxy
Canopy Glue
Thin CA
Medium CA
Threadlock, low and high strength

BUILDING PRECAUTIONS

Prepare the work surface prior to beginning the build. The surface should be soft and free of any sharp objects. We recommend resting the airframe parts on a soft towel or pit mat to prevent scratching or denting the surface of the aircraft.

TRANSPORTATION AND STORAGE

Use the three-view drawing on page 90 to determine how much room will be required to transport and store your model. We also recommend the use of wing and stabilizer bags to help protect these surfaces during transport and storage. The control horns and linkages can cause damage to other surfaces even when placed in storage bags. Always transport and store the wings and stabilizer so the linkages do not contact other panels to prevent damage.

CHECKING BLIND NUTS

When building the aircraft, you will be required to thread machine screws into blind nuts. We recommend pre-threading the screws to make sure the blind nuts are clear of any debris. If the screws do not thread in easily, clear the threads using the appropriate tap and tap handle.

PRINTED COVERING NOTES

- The covering used on your model has the color and markings printed directly on the film.
- The covering has a self-adhesive backing. Heat can be applied to shrink the covering, use indirect heat so as to not damage the film. Use a covering iron on low and place a piece of parchment paper or covering backing between the model and covering iron to disperse the heat. A heat gun can also be used to shrink the covering. Apply heat sparingly (2-3 seconds), and use a glove to press the covering into concave areas.
- Use only mild cleaning agents on the printed finish. Denatured alcohol is the most aggressive agent we recommend, but test on an inconspicuous area first. Prolonged use will remove the printed detail.
- Use tape with care. Anything other than low-tack tape can remove the finish, particularly on edges.
- Avoid contact with raw fuel. Prolonged exposure to fuel or chemicals may damage to the printed covering.
- Remove exhaust residue as soon as practical to avoid staining or damaging of the finish.

FLAP HINGING

1. Remove the flap and flap hinges from the wing panel.

→ The hinges are not glued to the wing or flap.

→ Optional: Apply a piece of white covering for a more finished appearance.

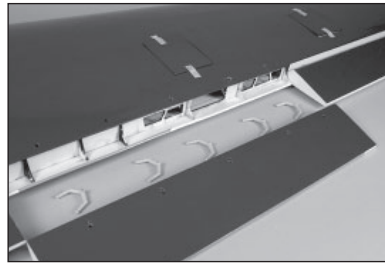

2. Use a hobby knife and covering iron to seal the covering into the recessed control horn mounting area on the leading edge of the flap.



3. Check the hinges to make sure they operate freely. Adjust the tension of the screw if any hinges do not move freely. Apply a small amount of petroleum jelly to the hinge flex points to prevent adhesive from entering the hinge.

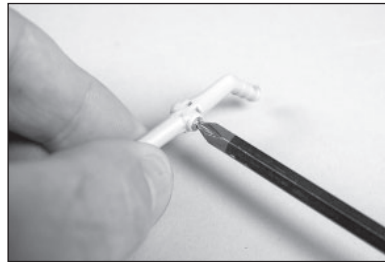

4. Check the fit of the flap to the wing using the hinges. The flap will align with the wing root. The hinge gap will be equal along the length of the flap.

→ Do not apply any adhesives until instructed to do so.

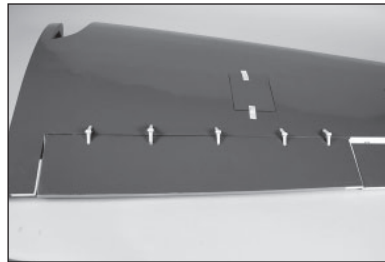

5. Check the gaps between the aileron and flap, and the wing root and flap. The flap will also align with the trailing edge at the aileron and wing root. The flap and wing lower surfaces will align.



6. Remove the flap and hinges. Inject adhesive into each of the hinge pockets of the flap.

→ Deluxe Materials Aero Tech Epoxy (DLMAD64) is recommended.

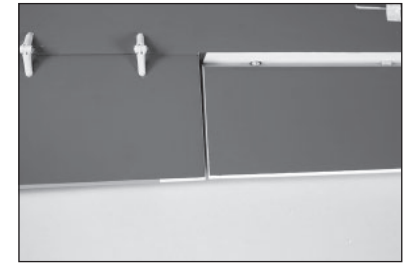

7. Inject adhesive into each of the hinge pockets of the wing.



8. Apply a small amount of adhesive to each hinge where it will enter the flap and wing.

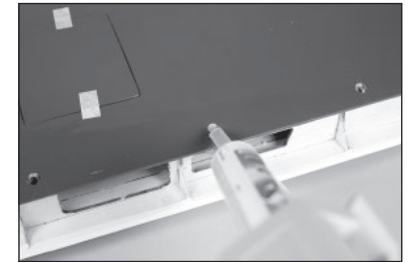

9. Place the hinges in the flap, then join the flap to the wing. Check the alignment as outlined in Step 5.

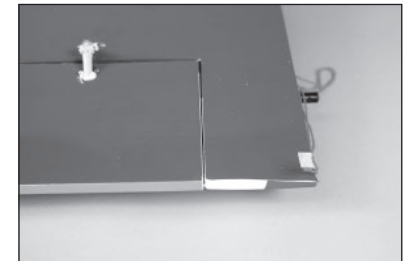
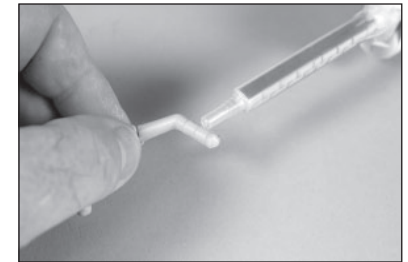

10. Use a paper towel and isopropyl alcohol to remove any excess adhesive. Use low-tack tape to hold the flap in position until the adhesive fully cures.

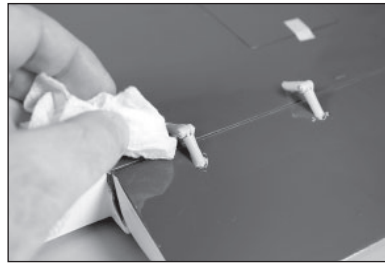

AILERON CONTROL HORN AND HINGING

11. Remove the aileron and aileron hinges from the wing.

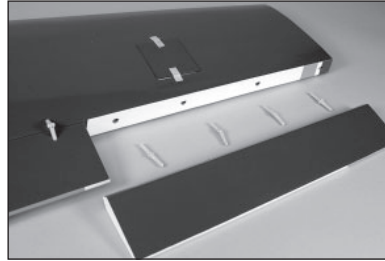

12. Lightly rub a finger over the bottom of the aileron to locate the mounting slots for the aileron control horns. Use a hobby knife and #11 blade to remove the covering for the aileron control horns.



13. Lightly sand the area of the aileron control horns where they fit into the aileron. (The aileron control horns are the longest horns included.)

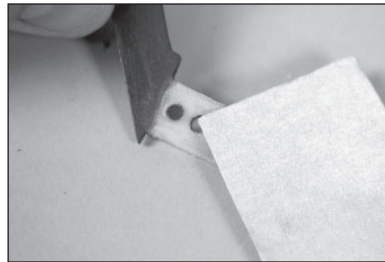

14. Use a paper towel and isopropyl alcohol to remove any oils or debris from the control horn. Prepare all four aileron control horns.



15. Test fit the aileron control horn. They should fit completely into the slot as shown. If they don't fit, use a file to enlarge the slot. Do not force the horn into place.



16. Snap the aluminum ball into the plastic ball end.

- Apply a drop of light machine oil to the ball to allow it to move freely in the plastic ball end.

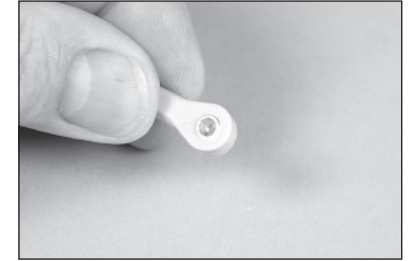

17. Slide an M3 x 15 button head machine screw into the ball. It may be necessary to use a small round file to remove any burrs from inside the aluminum ball. Prepare two ball ends.

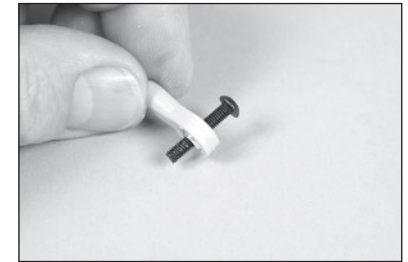

18. Slide an M3 washer on the M3 x 15 button head machine screw. Pass the screws into one of the control horns, then slide the ball end on the screw.

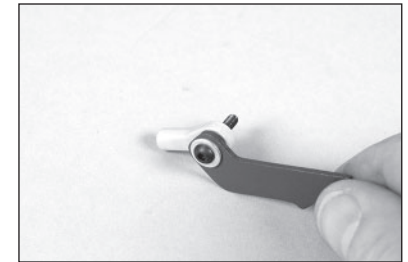

19. Slide the remaining control horn on the M3 x 15 button head machine screw. Secure the assembly using an M3 washer and an M3 locknut.

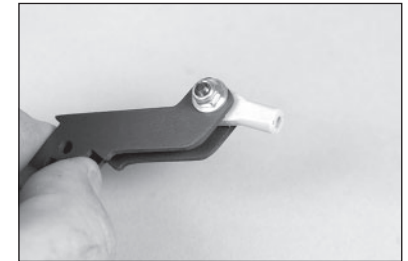

20. Slide the control horn base on the bottom of the control horn assembly.

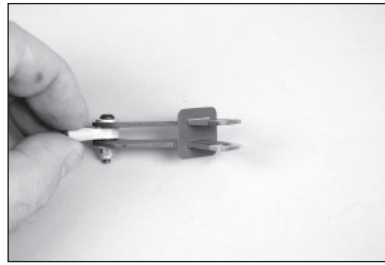

21. Fit the assembly into the slots in the aileron.



22. Place low-tack tape around the control horn base. This will help keep excess epoxy off the aileron.



23. Remove the assembly and mix 1/2 ounce (15ml) of 30-minute epoxy. Apply epoxy in the control horn slots.

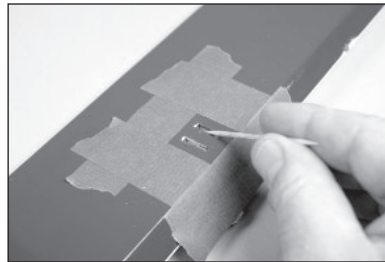

24. Apply epoxy to all the surfaces of the control horns that will contact the exposed wood of the aileron.

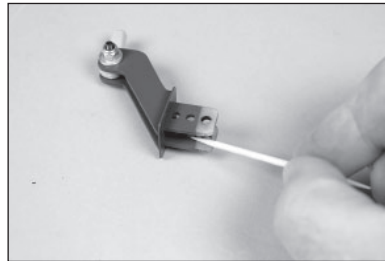

25. Fit the assembly into the aileron. Use a paper towel and isopropyl alcohol to remove any excess epoxy. Allow the epoxy to cure, then remove the tape.

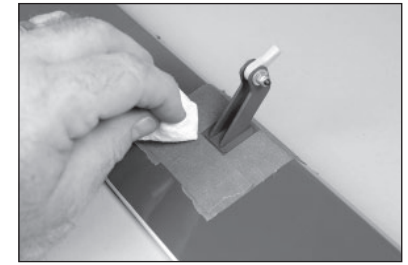

26. Hinge the ailerons using the same technique outlined for the flap hinges. Make sure the aileron is aligned with the flap.

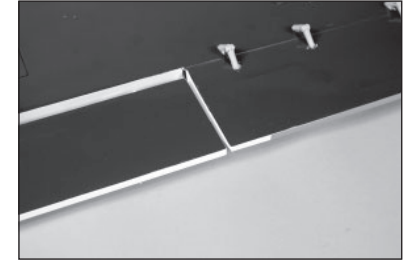

27. Make sure hinge gap is consistent along the entire length of the aileron. Use low-tack tape to hold the aileron in position until the adhesive has fully cured.

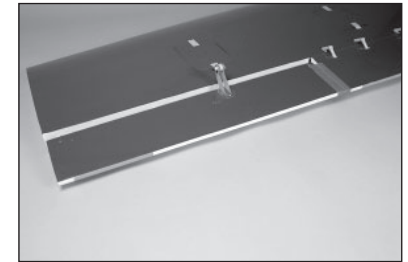

- Trial fitting the tip tank at this stage allows for the installation of the aileron and verification that the aileron will not come in contact with the tip tank.

AILERON SERVO INSTALLATION

28. Remove the covering for the servo arm in the aileron servo cover using a hobby knife and #11 blade.

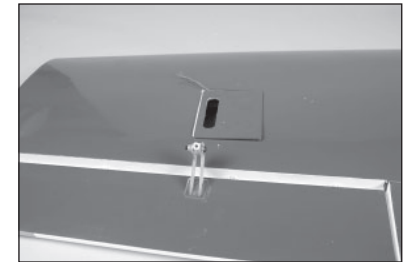

29. Place the aileron servo on the cover and use a felt-tipped pen to mark the locations for the mounting screws. The servo output will face forward.

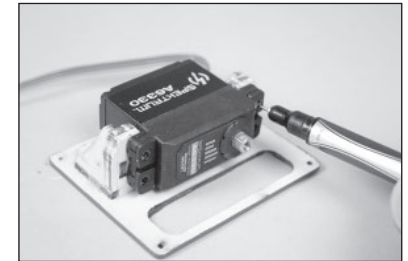

- 30.** Remove the servo and use a pin vise with a 1/16-inch (1.5mm) drill bit to drill the four servo mounting holes.

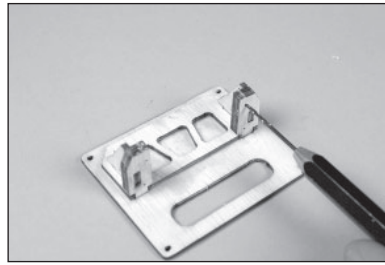

- 31.** Thread a servo mounting screw into each hole, then remove the screws.

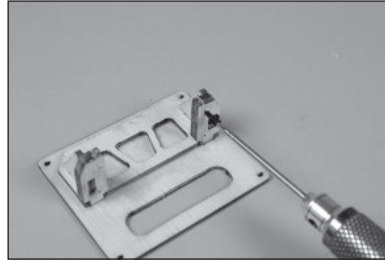

- 32.** Apply 1–2 drops of thin CA in each hole to harden the surrounding wood. Allow the CA to fully cure before proceeding.

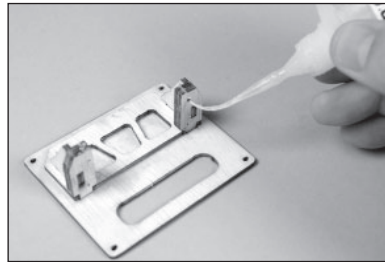

- 33.** Mount the servo using the screws provided with the servo. Center the servo and attach the servo arm perpendicular to the servo centerline. Remove any arms that will interfere with the operation of the servo.

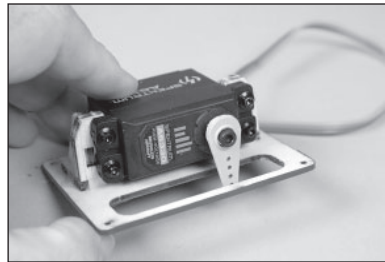

- 34.** When connecting the clevis to the servo arm, use the hole that is 5/8 inch (16mm) from the center of the servo arm.

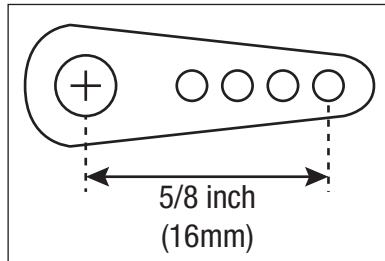

- 35.** Secure a 12-inch (300mm) servo extension to the servo lead using a Servo Connector Clip (SPMA3054).

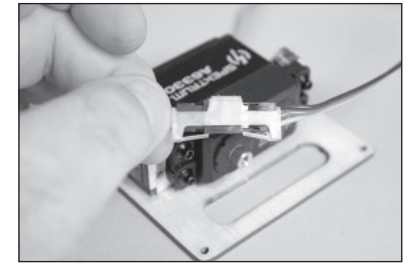

- 36.** Tie the string inside the wing to the end of the extension.

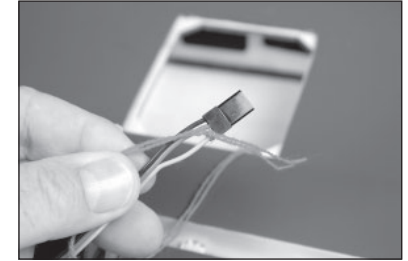

- 37.** Remove the cover for the flap servo. Use the string to pull the extension to the opening for the flap servo.

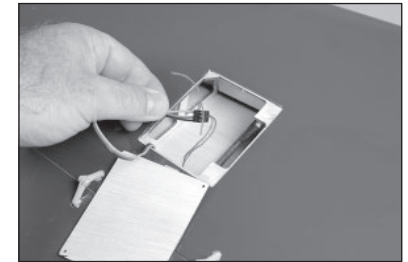

- 38.** Use a toothpick or hobby knife with a #11 blade to puncture the aileron servo cover for the mounting screws.

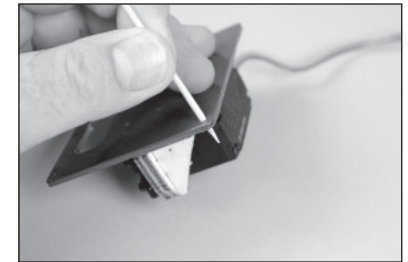

- 39.** Place the aileron servo cover in position and drill through the mounting locations and into the wing using a pin vise and 3/64-inch (1.2mm) drill bit.

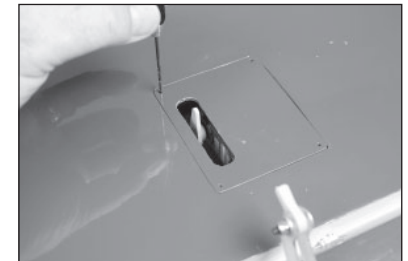

40. Use a #1 Phillips screwdriver to thread an M2 x 8 self-tapping screw into each of the holes. Remove the screws before proceeding.

→ Do not apply too much force when installing these screws, as it may damage the wooden servo hatch frame.



41. Apply 1–2 drops of thin CA in each hole to harden the surrounding wood. Allow the CA to fully cure before proceeding.

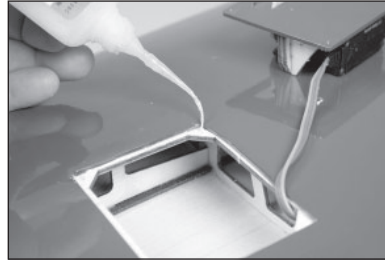

42. Secure the aileron servo cover using a #1 Phillips screwdriver and four M2 x 8 self-tapping screws.

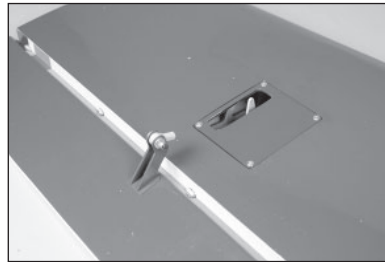

43. Slide a silicone retainer on the metal clevis. Thread the clevis on the 70mm threaded rod (on the end with the nut) until the end of the threaded rod is visible between the forks of the clevis.

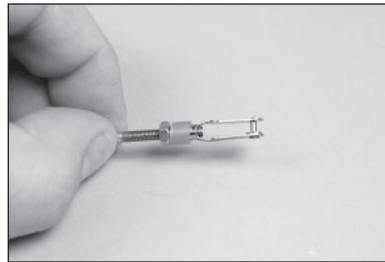

44. Remove the ball from the aileron control horn. Assemble the linkage so the length is 3¾ inches (95mm).

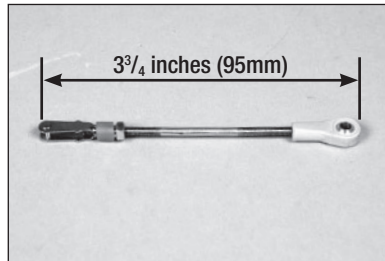

45. Attach the ball end to the control horn, then the clevis to the servo arm. With the radio system on and the aileron servo centered, adjust the linkage to center the aileron. Once adjusted, slide the silicone retainer over the forks of the clevis.

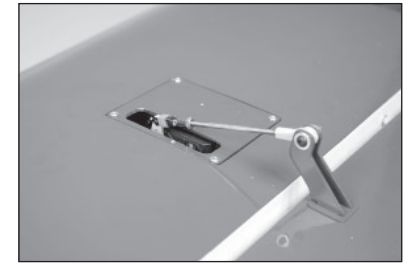

FLAP SERVO INSTALLATION

→ Before starting the flap servo installation, ensure the Flap System travel is zero for all switch positions.

46. Snap the aluminum ball into the plastic ball end.

→ Apply a drop of light machine oil to the ball to allow it to move freely in the plastic ball end.

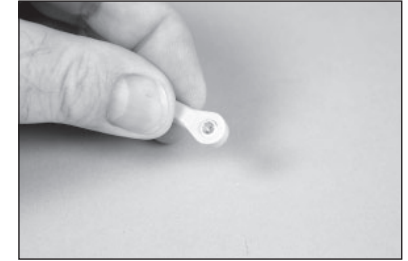

47. Slide an M3 x 15 button head machine screw into the ball. It may be necessary to use a small round file to remove the any burrs from inside the aluminum ball. Prepare four ball ends.

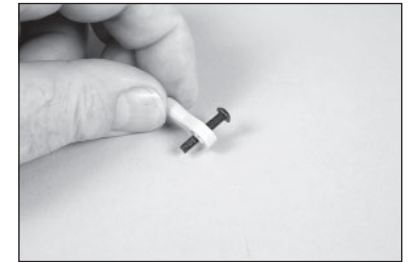

48. Remove any tape from the wing and flap. Assemble the flap linkage using two prepared ball ends and an 80mm threaded rod. Thread the ball ends equally on the threaded rod until the length is approximately 4¼ inches (108mm).

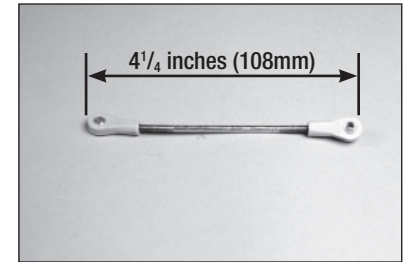

49. Center the flap servo using the radio system. Fit the flap servo arm on the servo so it is perpendicular to the servo centerline.

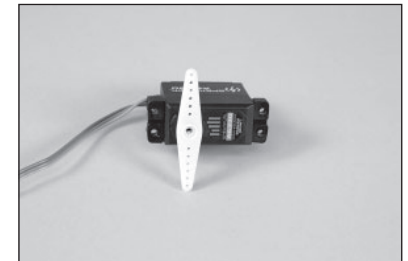

50. Place the flap servo into position with the output forward. Use side cutters to remove the excess servo arm extending out of the servo opening.

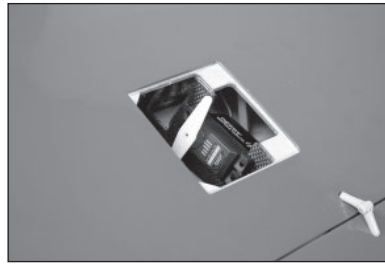

51. Attach the ball end to the servo arm using an M3 x 15 machine screw, M3 washer and M3 locknut. Tighten the hardware using a 2mm hex wrench and 5.5mm nut driver. Make sure not to overtighten the hardware.

- The washers must be installed as shown to prevent the ball from popping out of the ball end.
- Trim any excess servo arm extending beyond the ball end.
- When connecting the clevis to the servo arm, use the hole that is 5/8 inch (16mm) from the center of the servo arm.

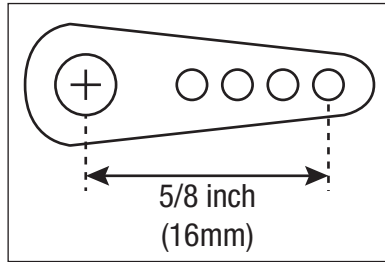

52. Install the flap servo with the output forward. Use the hardware included with the servo.

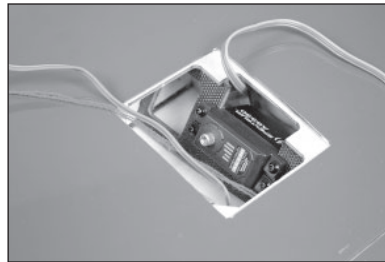

53. Guide the servo lead for the flap and aileron through the wing to the wing root.

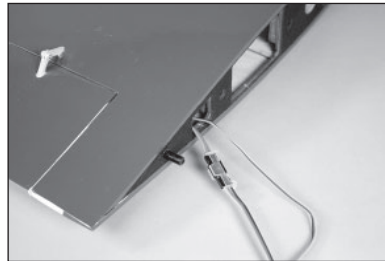

54. Center the servo using the radio system. Place the servo arm on the servo so it is one spline toward the trailing edge of the wing.

- Do not secure the servo arm to the servo until instructed to do so.

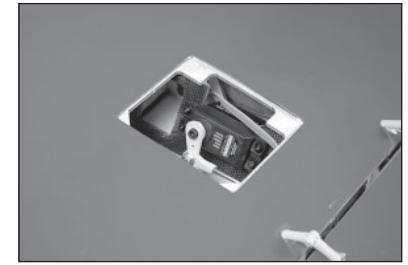

55. Position the linkage so it is perpendicular to the flap hinge line.



56. While holding the linkage, deflect the flap. Use a felt-tipped pen to mark the location of the ball end on the bottom of the wing.

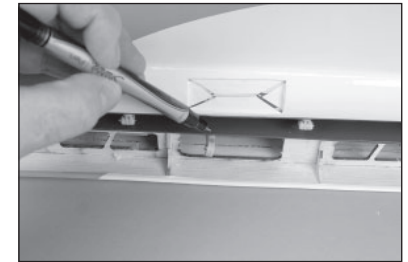

57. Use a felt-tipped pen to transfer the mark onto the flap and into flap control horn mounting area.

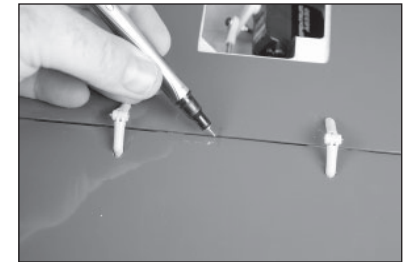

58. Position the flap control horn on the flat area of the flap, centered with the mark made in the previous step. Slide the flap control horn toward the bottom of the flap with the flat portion of the control horn facing the bottom of the wing. Mark the location of the flap horn mounting screws using a felt-tipped pen.



- 59.** Place the horn aside. Use a 1/16-inch (1.5mm) drill bit to drill the two holes for the flap control horn mounting screws.

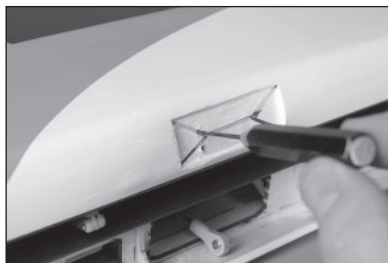

- 60.** Use a #1 Phillips screwdriver to thread an M3 x 14 self-tapping screw into each hole. Remove the screws before proceeding.

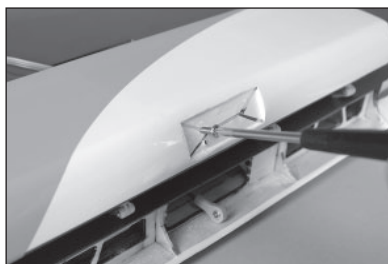

- 61.** Place 2–3 drops of thin CA in each hole. Allow the CA to fully cure before proceeding.



- 62.** Secure the flap control horn to the flap using two M3 x 14 self-tapping screws and a #1 Phillips screwdriver. Note the orientation of the flap control horn.



- 63.** Secure the ball link to the flap control horn using an M3 x 15 machine screw and M3 washer. Use a 2mm hex wrench to tighten the screw.



- The servo horn can be removed from the servo to manipulate the linkage.

- 64.** Adjust the linkage for the mid flap position of 1 inch (25mm).

- Once adjusted, secure the servo arm to the servo using the hardware included with the servo.

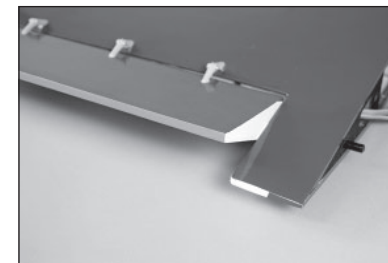

- 65.** Set the travel on the transmitter to the flaps up position. Adjust the values at the transmitter to align the flap to the wing trailing edge.



- 66.** Set the travel on the transmitter to achieve full flap deflection of 2 3/4 inch (70mm).

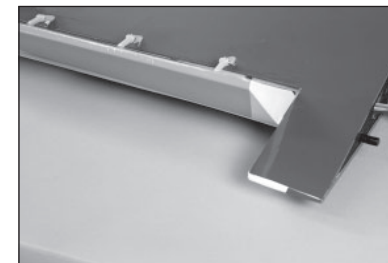

67. Attach the servo cover to the wing using four M2 x 8mm self-tapping screws.

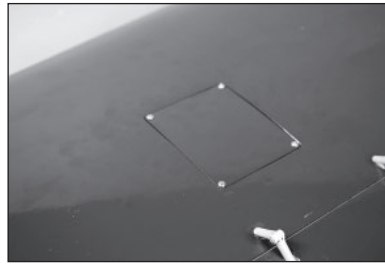

ELEVATOR HINGING

68. Separate the elevator from the stabilizer. Set the hinges aside.

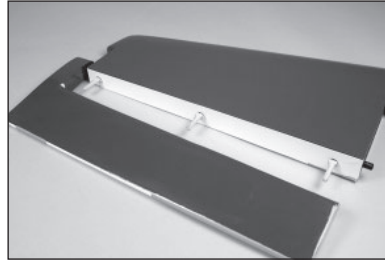

69. Install the control horn for the elevator using the techniques used for the aileron control horn.



70. Use the same technique as the flap hinges to secure the elevator hinges. Make sure to remove any excess adhesive from the hinges using a paper towel and isopropyl alcohol. Use low-tack tape to hold the elevator in position until the adhesive has fully cured.



RUDDER HINGING

71. Separate the rudder from the fin. Set the hinges aside.

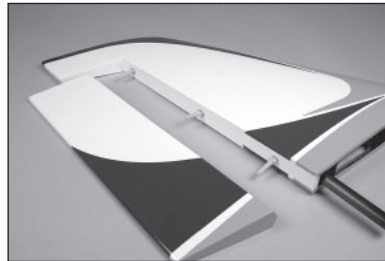

72. Install the control horn for the rudder using the techniques used for the aileron control horn.

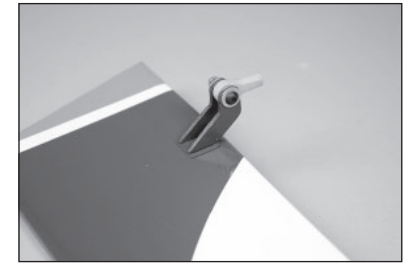

73. When installing the rudder hinges, note that the bottom hinge has been shortened to fit behind the fin joiner tube.

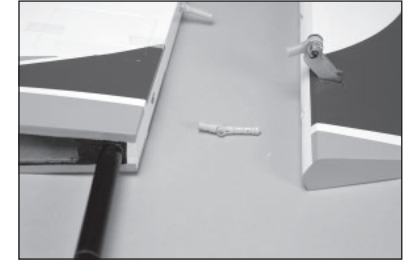

74. Use the same technique as the flap hinges to secure the rudder hinges. Make sure to remove any excess adhesive from the hinges using a paper towel and isopropyl alcohol. Use low-tack tape to hold the rudder in position until the adhesive has fully cured.

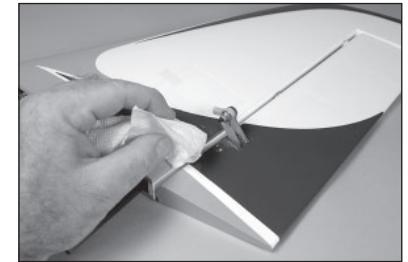

RUDDER SERVO INSTALLATION

75. Mount the rudder servo following the instructions in the aileron servo installation. The output of the rudder servo will face forward.

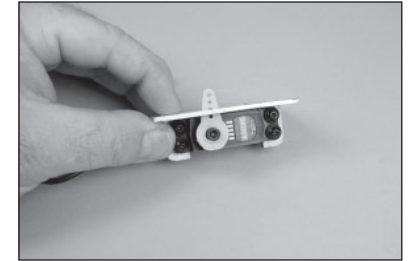

76. Secure the rudder servo in the fin following the instructions in the aileron servo installation section.

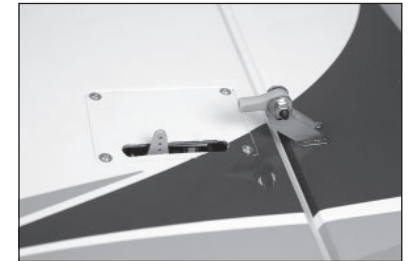

77. Assemble the rudder servo linkage. Use a 35mm threaded rod and adjust the linkage to an overall length of 65mm. Adjust the length of the linkage as necessary to center the rudder with the radio system on.

→ When connecting the ball end to the servo arm, use the hole that is 13/16 inch (20mm) from the center of the servo arm.



ELEVATOR SERVO INSTALLATION

78. Use a hobby knife and #11 blade to remove the covering for the elevator servo arm.

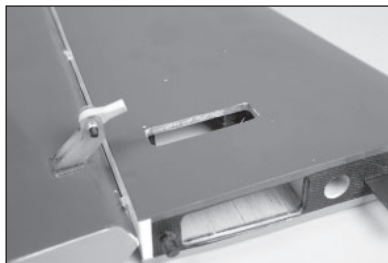

79. Mount the elevator servo in the stabilizer with the servo output facing forward.

→ Caution: Use care when locating the servo mounting holes so they are evenly spaced from the notch for the servo lead.



80. Assemble the elevator servo linkage following the instructions in the aileron servo installation. Use a 40mm threaded rod and adjust the linkage to an overall length of 65mm. Adjust the length of the linkage as necessary to center the elevator with the radio system on.

→ When connecting the clevis to the servo arm, use the hole that is 13/16 inch (20mm) from the center of the servo arm.

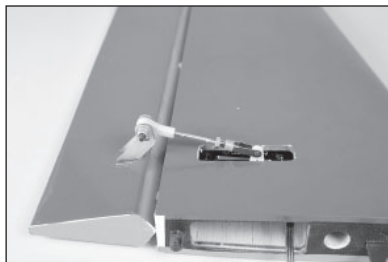

MAIN RETRACT INSTALLATION

81. Assemble an adapter to power the retract module. Use the connector supplied with the retract module and a connector compatible to the battery chosen to power the module.

→ Make sure to double check the polarity, as reverse polarity will damage the retract unit beyond repair.



82. Use a hobby knife or sandpaper to sand a slight taper on each of the plugs on the leads (included with the retract module) that will connect to the receiver to the retract module.



83. Remove the covering from the retract well on the bottom of the wing using a hobby knife with a #11 blade. Leave enough covering to seal into the wheel well. Use a covering iron to seal the covering around the opening.

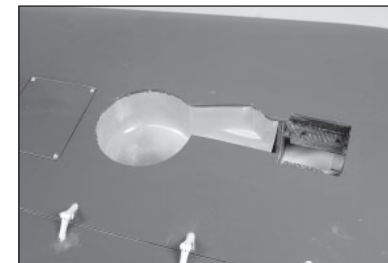

84. Route the brake lead and control lead from the retract into the wing.

→ The excess lead can be coiled and secured with a zip tie in the wing root.



85. Retrieve the leads from the same location as the flap and aileron leads. Make sure to label the leads so they can be identified when assembling the model for flight.



86. Prepare the retract mounting screws by sliding a 4mm lock washer, then a 4mm washer on the M4 x 20 socket head cap screws. Prepare all four mounting screws.



87. Secure the retract in the wing using the four screws prepared in the previous step and a 3mm hex wrench.

→ Use threadlock on the screws to prevent them from vibrating loose.

→ Do not overtighten the retract mounting screws.

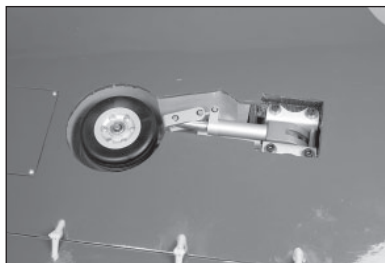

88. Check the operation of the retract using the retract module. A test button is located on the module, or the module can be connected to the receiver to check the retract operation.



NOSE GEAR RETRACT INSTALLATION

89. Remove the canopy from the forward fuselage. Set the canopy aside in a safe location.

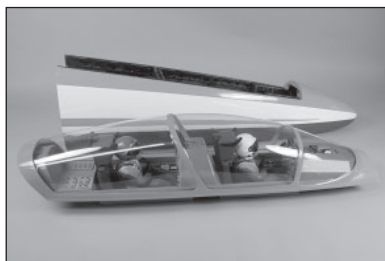

90. Mount the steering servo in the retract servo opening using four M3 x 12 button head screws. Apply a drop of threadlock on each screw, then tighten the screws using a 2mm hex wrench.

→ Some servos may require the orientation to be reversed to avoid contacting the retract unit. To do so may require a different length pushrod.



91. Assemble the steering linkage and attach it to the servo arm using an M3 x 15 button head screw, M3 washer and M3 lock nut. Use a 2mm hex wrench and 5.5mm nut driver.

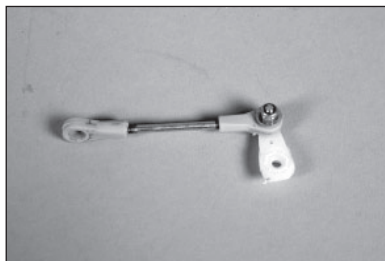

92. Snap the ball on the steering arm of the retract. Center the steering servo and adjust the length of the linkage to center the nose gear.

→ Make sure to adjust the servo travel so equal deflection is achieved in each direction. Also make sure the servo is not over traveling as this may damage the ball attached to the nose leg.



93. Fit the retract into the forward fuselage. Make sure all the leads are inside the fuselage and not between the retract frame and fuselage.

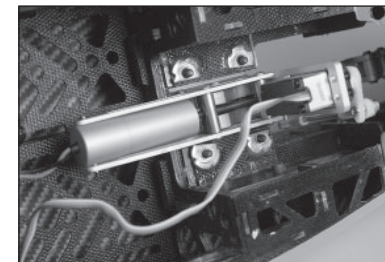

94. Route the leads for the retract and servo on opposite sides of the fuselage.

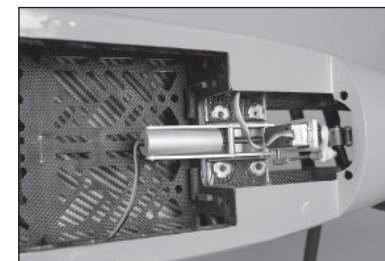

95. Secure the retract using four 4mm lock washers, four 4mm washers and four M4 x 20 socket head cap screws. Tighten the screws using a 3mm hex wrench.

→ Use threadlock on the screws to prevent them from vibrating loose.

→ Do not overtighten the retract mounting screws.

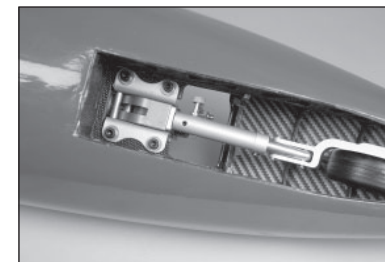

BATTERY, RECEIVER AND RETRACT MODULE INSTALLATION

96. Mount the batteries for the receiver and retract module in the front of the fuselage using hook and loop tape, and hook and loop straps.

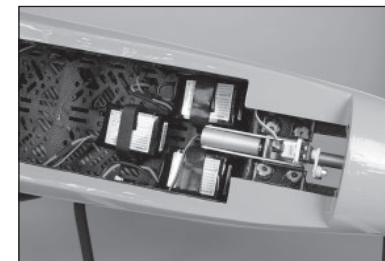

97. The retract module can be mounted forward of the aft edge of the nose section. Make sure access to the connecting bolts are not blocked. Use a switch between the retract battery and retract module so the retract system can be switched on or off.

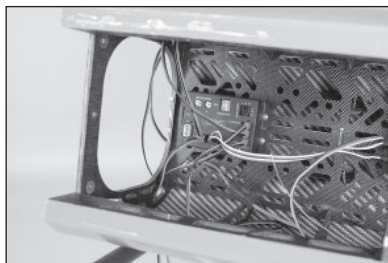

98. Mount the receiver in the fuselage following the instructions provided with the receiver.

→ The leads between the retract module and receiver can be connected, as well as the receiver batteries and nose gear steering.

→ Connect the leads for the main gear retracts and brakes, as well as the connections to the receiver.

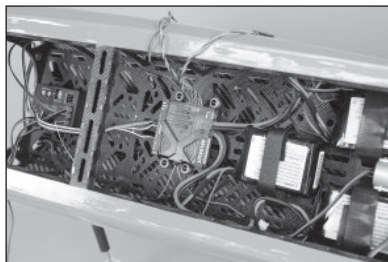

99. Mount the receiver switch in a convenient location in the fuselage. One of the remote receivers can be secured in the forward section of the forward fuselage using hook and loop tape.

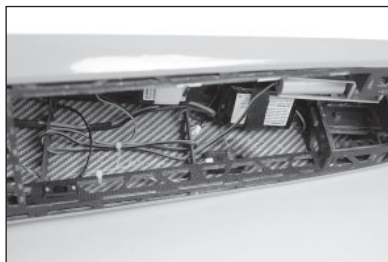

100. Mount a second remote receiver in the fuselage using hook and loop tape. Make sure the antennas are oriented in different directions.



FUEL TANK ASSEMBLY

101. Locate the rubber stopper, aluminum backplate and aluminum cap.



102. Slide a long tube and a short tube through the rubber stopper. (The center hole is for the screw that secures the assembly in the tank.) Fit the aluminum backplate on the tubes from the unflanged end of the stopper. The aluminum front plate slides on the tubes from the flanged end of the stopper.

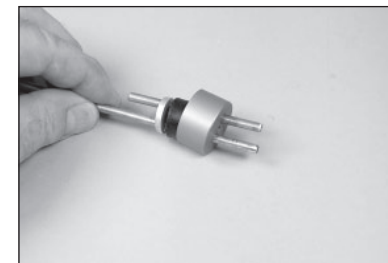

103. Use a tubing bender to bend the longer (vent) tube upwards.



104. Check the bend in the tubing to make sure it does not touch the top of the tank.

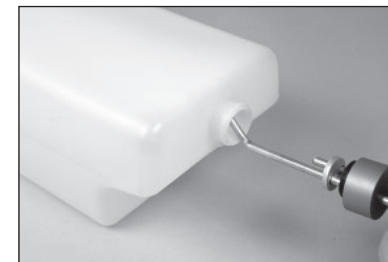

105. Use a soldering iron and solder to create an area on each of the tubes (both outside, and the unbent tube inside the tank) so the fuel tubing can be secured to the tubes.

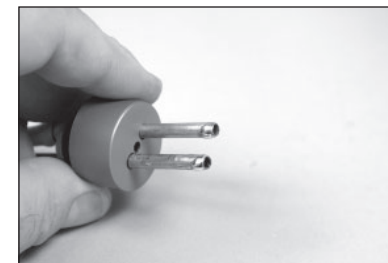

106. Cut a piece of fuel tubing and slide it on the clunk line for the fuel tank. Fit the clunk and measure the length shown. Adjust the length of the tubing to achieve the measurement.

→ Check the clunk is free of obstructions before connecting it to the tubing.

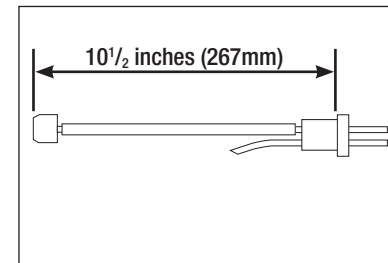

107. Use a wire tie to secure the fuel line to the brass fuel line.

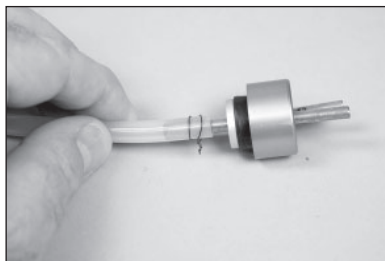

108. Use a wire tie to secure the fuel line to the clunk.

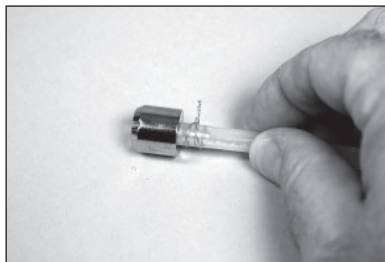

109. Fit the stopper in the tank and check that the clunk can move freely in the tank. Adjust if necessary. Secure the stopper using the M3 x 25 socket head cap screw. Tighten the screw using a 2.5mm hex wrench.



→ Do not overtighten the screw and damage the fuel tank.

110. Remove the hatch from the bottom of the rear fuselage and set it aside in a safe location.



111. Remove the hatch from the top of the rear fuselage and set it aside in a safe location.

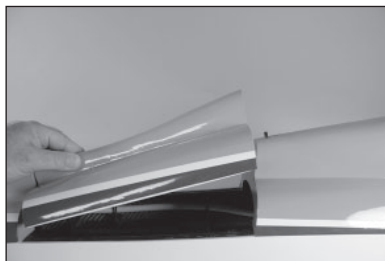

112. Mount the fuel tank tray in the fuselage from the bottom using the four knurled screws.

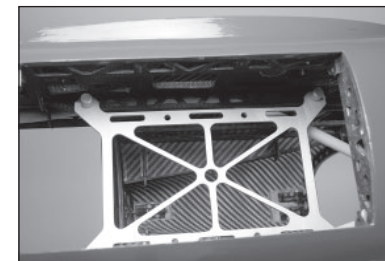

113. Pass the three tie wraps around the fuel tank tray so the fuel tank can be secured to the fuel tank tray.

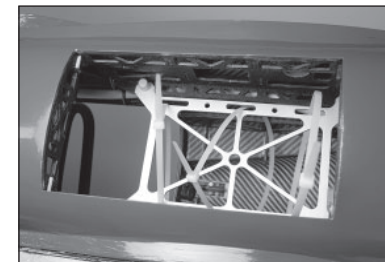

114. Slide the fuel tank into the fuselage. Use a small amount of silicone adhesive between the tray and tank to keep it from sliding on the tray during flight.

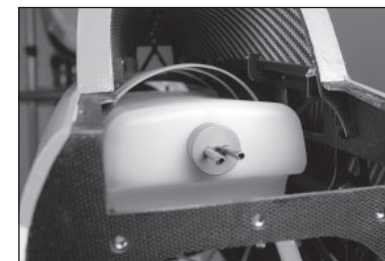

115. Adjust the position of the tank so the top hatch can be installed.



116. Secure the tank using the tie wraps. Trim the excess using side cutters.



117. Remove the covering for the fill and vent fittings using a hobby knife and #11 blade. Mount the fittings and connect the lines from the tank.

→ It may be necessary to enlarge the holes to install the fittings.

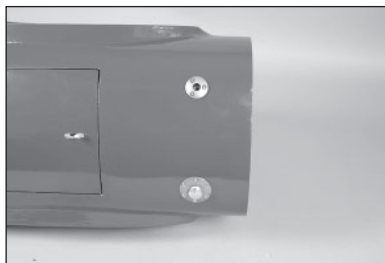

ELEVATOR AND RUDDER EXTENSION INSTALLATION

118. Locate the servo wire routing sleeve in the rear fuselage in the fin location. Tie the string to a 48 inch (1200mm) extension.



119. Wrap tape around the connection between the plug and string to make pulling the extension through the sleeve easier.



120. Use the string to pull the extension through the sleeve. Be careful not to break the string.

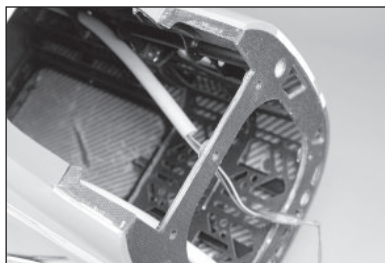

121. Locate the servo routing sleeve in the rear fuselage in the stabilizer location. Tie the string to two 48 inch (1200mm) extensions. Make sure the plugs connect to the receiver.



122. Use the string to pull the extensions through the sleeve. Be careful not to break the string.

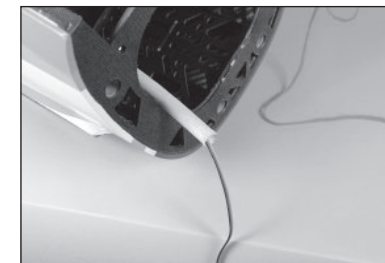

123. Slide the servo routing sleeves as far back as possible. Mark the sleeves at the bulkhead so the positioning can be checked before each flying session. Use tie wraps to secure the sleeves to the structure above the location for the thrust tube, so they don't come in contact with the exhaust tube during the operation of your model.

TURBINE INSTALLATION

124. Fit the exhaust guard to the rear of the fuselage so it equally covers the fuselage. Secure the guard using two M3 x 12 self-tapping screws.

→ Failure to fit the exhaust guard will result in heat damage to the wood and covering above the tailpipe at the rear of the fuselage.

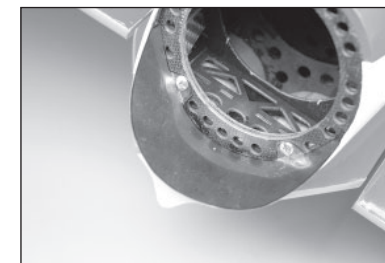

125. Slide the exhaust tube into the rear fuselage from the front of the fuselage.

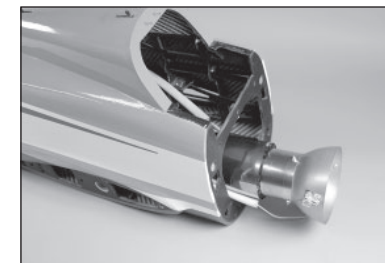

126. Align the end of the exhaust tube so it extends 1/4 to 1/2 inch (6mm to 13mm) beyond the fuselage former at the rear.

→ It may be necessary to slide a thin steel ruler (or similar) between the exhaust tube and opening in the fuselage to aid the tailpipe fitting through the end fuselage former. This is designed to be a snug fit.

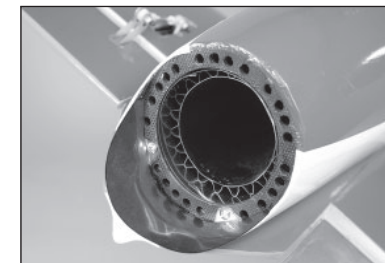

- 127.** Space the exhaust tube equally between the sides of the fuselage. Secure the tube using four M3 x 12 self-tapping screws.

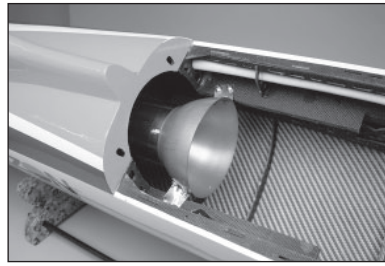

- 128.** Position the turbine so the distance between the tail cone and exhaust tube match the recommendations from the turbine manufacturer.

→ The mounting rails can be modified to fit a variety of turbines.

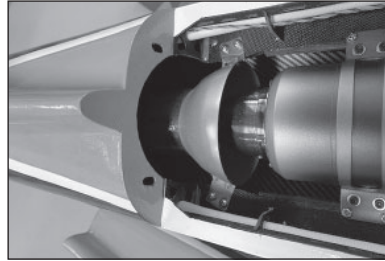

- 129.** Position the turbine in accordance to the distance relative to the tailpipe stated in the operations manual of your turbine manufacturer.



- 130.** Mount the fuel pump in the fuselage and connect any fuel lines necessary for the operation of the turbine. Connect the vent line from the tank. Secure all connections using wire ties.

→ Do not use tie wraps to secure the fuel lines.

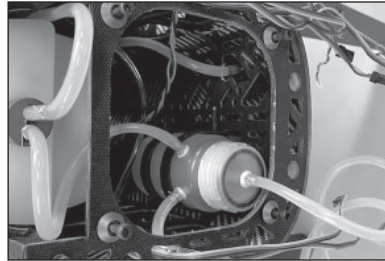

FIN INSTALLATION

- 131.** Secure the lead from the rudder servo and extension using a commercially available retainer.

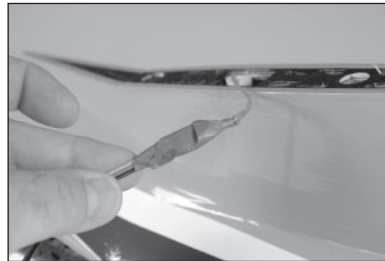

- 132.** Mix 1/2 ounce (15ml) of 30-minute epoxy. Use an epoxy brush to apply epoxy in the tubes in the fuselage for the fin and to the surrounding wood.

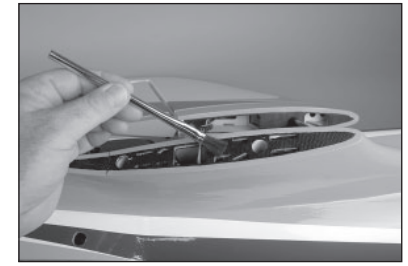

- 133.** Fit the fin into position. Place a small piece of plastic in the hinge line and along the bottom of the rudder to prevent gluing the rudder to the fuselage. Remove any excess epoxy using a paper towel and isopropyl alcohol.



STABILIZER INSTALLATION

- 134.** Insert the stabilizer tube in the socket in the rear of the fuselage. Center the tube in the fuselage.

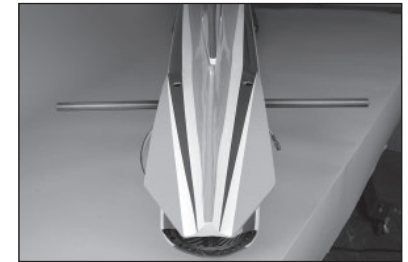

- 135.** Connect the lead from the elevator servo and extension using a commercially available fastener. Slide the stabilizer on the tube. Use a 3mm hex wrench to tighten the screw that secures the stabilizer to the fuselage.

→ The screw may require loosening to install the stabilizer.

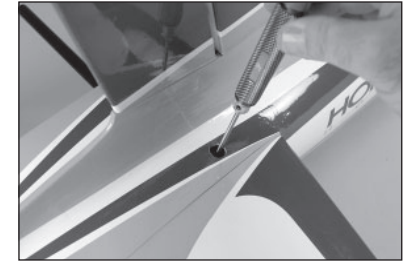

- 136.** Insert the stabilizer screw grommet using a small amount of silicone adhesive.

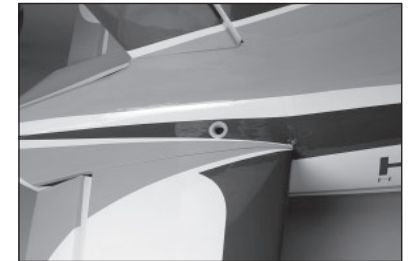

JOINING THE FUSELAGE

137. Slide the four fuselage joining tubes into the front half of the fuselage.

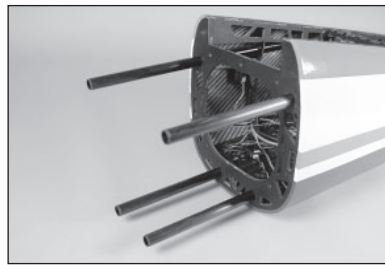

138. Prepare the five screws that secure the forward fuselage to the rear fuselage by sliding a tapered washer on an M4 x 20 socket head cap screw.



139. Slide the forward fuselage into position on the rear fuselage.



140. Secure the fuselage section using the five screws prepared earlier. Tighten the screws using a 3mm hex wrench.

- Use threadlock to keep the screws from vibrating loose.
- Check the screws periodically to ensure they remain secure.

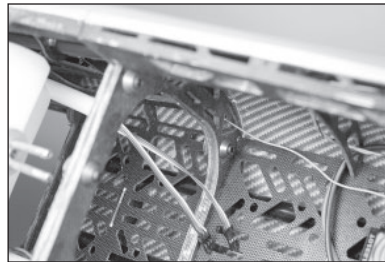

141. Mount the remote receiver above the fuel tank using hook and loop tape. Connect any extensions for the flaps, ailerons, retracts and brakes and route them through the fuselage.



142. Place the canopy hatch in position on the fuselage.



WING INSTALLATION

143. Slide the wing tube into the socket in the wing. Do not force the tube in farther than it will easily slide.



144. Slide the tube into the socket in the fuselage. Connect the leads for the aileron and flap to the extensions. Guide the leads for the retract and brake into the fuselage.

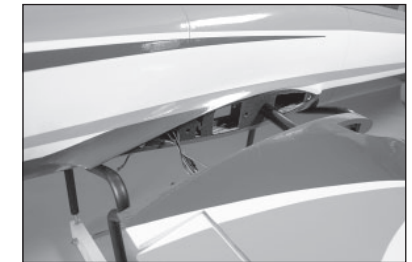

145. Slide the wing against the fuselage.

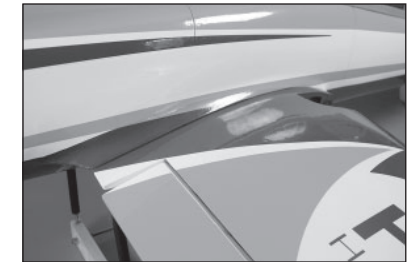

146. Use the two 1/4-20 x 2-inch nylon bolts to secure the wing to the fuselage.

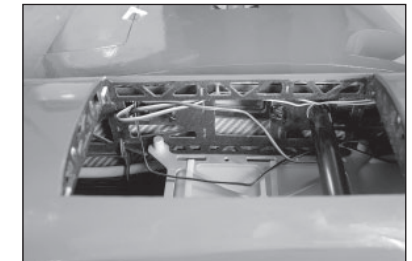

147. Connect the leads for the retract and brake inside the fuselage.

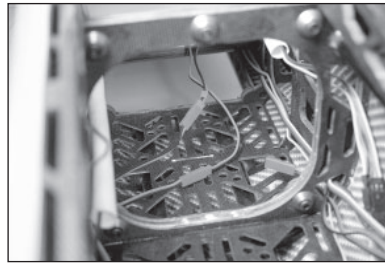

INTAKE INSTALLATION

148. Fit the intake to the wing. There will be space of 1/4-inch (6mm) at the rear corner near the fuselage.

→ The top of the intake is longer than the bottom.

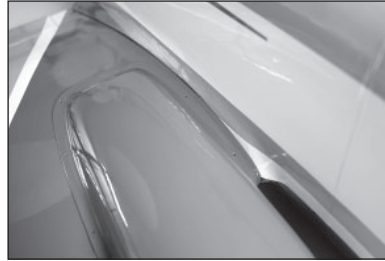

149. Use a pin vise and 1/16-inch (1.5mm) to drill the locations in the intake into the wing. Remove the intake and thread an M2 x 8 self-tapping screw into each hole. Remove the screws and place a drop of thin CA in each hole. Once the CA has fully cured, secure the intake to the wing using twelve M2 x 8 self-tapping screws.

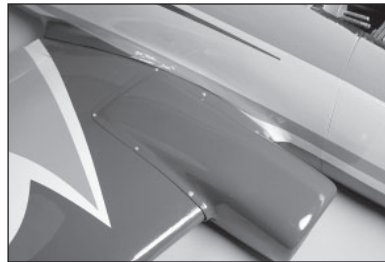

SCALE ACCESSORIES

150. Prepare the wing tip tank bolts by sliding a 4mm lock washer on the M4 x 20 socket head cap screws.



151. Attach the tip tank using the screws and a 3mm hex wrench.

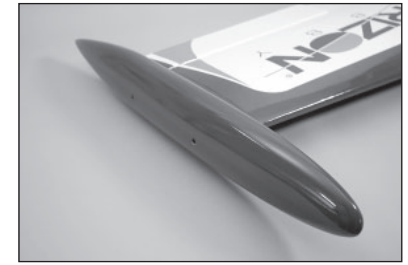

152. Use a hobby knife and #11 blade to remove the covering for the VOR blade antenna in the fin. Glue the antenna to the fin using medium CA. Use a square to make sure the antenna are aligned correctly on both sides of the fin.

→ The antenna are cosmetic and their installation is optional.

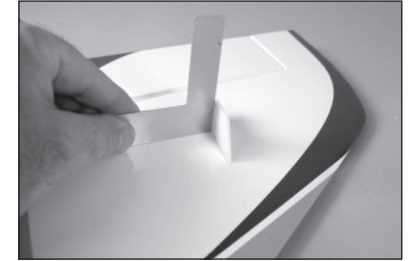

153. Slide a 4mm lock washer and 4mm washer on the M4 x 20 socket head cap screw for the ventral fin attachment. Prepare all four screws.



154. Use the screws and a 3mm hex wrench to attach the ventral fins to the bottom of the fuselage.

→ Remove the ventral fins for transport.

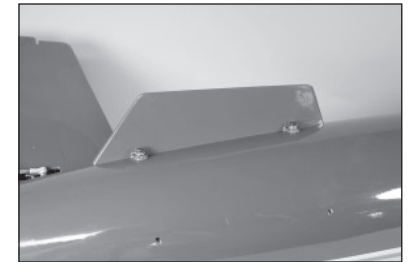

CENTER OF GRAVITY

An important part of preparing the aircraft for flight is properly balancing the model. The Center of Gravity range supplied here is a guideline based on testing. Deviation from the measurements we provide is possible and may result in a model that suits your flying style better. Start with the recommended Center of Gravity, then feel free to experiment with different balance points. We advise adjusting progressively and cautiously.

1. Assemble the model and ready it for flight. Make sure to connect the leads to the appropriate leads from the receiver. Make sure the leads are not exposed before tightening any hardware. Your model should be flight-ready before balancing.
2. The overall CG range for this model is 5–6 inches (127–152mm). We recommend starting in this range, then adjusting to suit your particular flying style.
3. When balancing your model, make sure it is assembled and ready for flight. Support the plane inverted, with the landing gear extended, at the marks made on the wing with your fingers or a commercially available balancing stand.

NOSE WEIGHT

A build with typical components results in needing between 0–8 ounces of nose weight.

The model is most accurately balanced inverted.

 **CAUTION:** You must adjust your aircraft's center of gravity and balance your model properly before attempting flights.

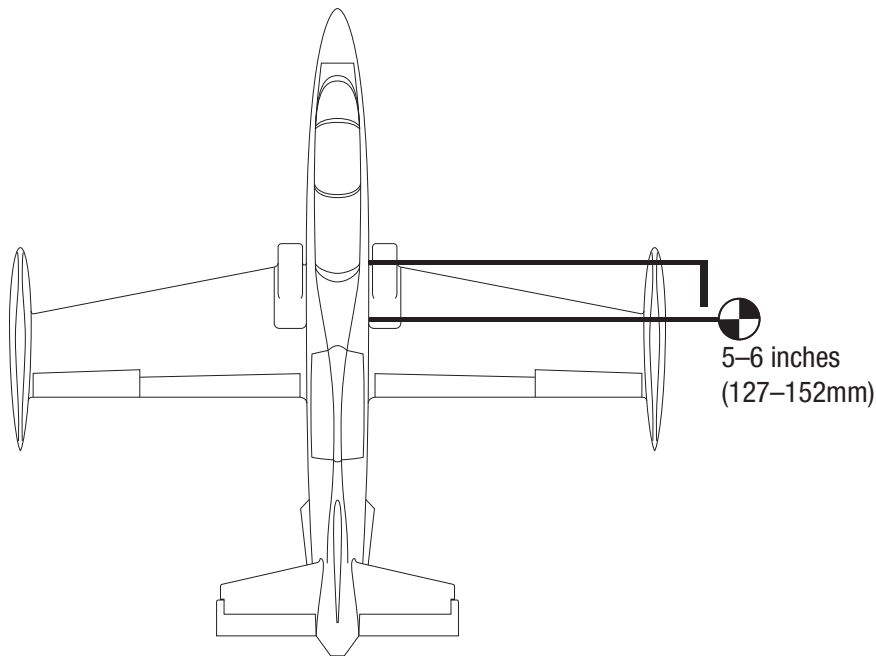

CONTROL THROWS

1. Turn on the transmitter and receiver of your model. Check the movement of the rudder using the transmitter. When the stick is moved to the right, the rudder should also move right. Reverse the direction of the servo at the transmitter if necessary.
2. Check the movement of the elevator with the radio system. Moving the elevator stick toward the bottom of the transmitter will make the elevator move up.
3. Check the movement of the ailerons with the radio system. Moving the aileron stick to the right will make the right aileron move up and the left aileron move down.
4. Use a ruler to adjust the throw of the elevator, ailerons and rudder.

Surface	Rate	Exponential	Direction	Throw
Aileron	High	20%	Up	1 ³ / ₈ inch (35mm)
			Down	1 inch (25mm)
	Low	15%	Up	1 inch (25mm)
			Down	25/32 inch (20mm)
Elevator	High	20%	Up	25/32 inch (20mm)
			Down	25/32 inch (20mm)
	Low	15%	Up	19/32 inch (15mm)
			Down	19/32 inch (15mm)
Rudder	High	20%	Left	2 ¹⁷ / ₃₂ inch (65mm)
			Right	2 ¹⁷ / ₃₂ inch (65mm)
	Low	15%	Left	1 ⁹ / ₁₆ inch (40mm)
			Right	1 ⁹ / ₁₆ inch (40mm)
Flaps			Partial	1 inch (25mm)
			Full	2 ¹ / ₄ inch (57mm)

Flap Throw

The full flap position creates a lot of drag, slowing the model very quickly. Test at a safe altitude.

MIXING

Flap to Elevator Compensation

There is no precise number for down trim required when flaps are applied. This can vary slightly from plane to plane and personal preference. Use the measurements provided as a starting point and adjust as necessary.

With partial flap set at 1 inch (25mm), mix 3/32-inch (2mm) of down elevator.

With full flap set at 2 1/4 inches (57mm), mix 3/16-inch (5mm) of down elevator.

A flight mode setting is very useful for this aspect of setup as it allows independent trim adjustment for each flap setting in flight. This allows for in-flight adjustments and not having to land to adjust via trial and error. Most modern computer radios offer flight mode trimming.

PREFLIGHT CHECKLIST

- Charge the transmitter, receiver, retract and ECU batteries. Follow the instructions provided with the charger. Follow all manufacturer's instructions for your electronic components.
- Check the radio installation and make sure all control surfaces (aileron, elevator, rudder, and flaps) move correctly (i.e., the correct direction and with the recommended throws).
- Check all the hardware (control horns, servo horns, and clevises) to make sure they are secure and in good condition.
- Prior to each flying session (and especially with a new model), perform a range check of your radio system. See your radio manual for the recommended range and instructions for your particular radio system.

DAILY FLIGHT CHECKS

- Check the battery voltage of the transmitter battery. Do not fly below the manufacturer's recommended voltage. Doing so can cause your aircraft to crash.
- Check all hardware (linkages, screws, nuts, and bolts) prior to each day's flight. Ensure that binding does not occur and that all parts are properly secured.
- Ensure all surfaces are moving in the proper manner.
- Perform a ground range check before each day's flying session.
- All servo leads and switch harness plugs should be secured in the receiver.

LIMITED WARRANTY

What this Warranty Covers

Horizon Hobby, LLC, (Horizon) warrants to the original purchaser that the product purchased (the "Product") will be free from defects in materials and workmanship at the date of purchase.

What is Not Covered

This warranty is not transferable and does not cover (i) cosmetic damage, (ii) damage due to acts of God, accident, misuse, abuse, negligence, commercial use, or due to improper use, installation, operation or maintenance, (iii) modification of or to any part of the Product, (iv) attempted service by anyone other than a Horizon Hobby authorized service center, (v) Product not purchased from an authorized Horizon dealer, (vi) Product not compliant with applicable technical regulations, or (vii) use that violates any applicable laws, rules, or regulations.

OTHER THAN THE EXPRESS WARRANTY ABOVE, HORIZON MAKES NO OTHER WARRANTY OR REPRESENTATION, AND HEREBY DISCLAIMS ANY AND ALL IMPLIED WARRANTIES, INCLUDING, WITHOUT LIMITATION, THE IMPLIED WARRANTIES OF NON-INFRINGEMENT, MERCHANTABILITY AND FITNESS FOR A PARTICULAR PURPOSE. THE PURCHASER ACKNOWLEDGES THAT THEY ALONE HAVE DETERMINED THAT THE PRODUCT WILL SUITABLY MEET THE REQUIREMENTS OF THE PURCHASER'S INTENDED USE.

Purchaser's Remedy

Horizon's sole obligation and purchaser's sole and exclusive remedy shall be that Horizon will, at its option, either (i) service, or (ii) replace, any Product determined by Horizon to be defective. Horizon reserves the right to inspect any and all Product(s) involved in a warranty claim. Service or replacement decisions are at the sole discretion of Horizon. Proof of purchase is required for all warranty claims. SERVICE OR REPLACEMENT AS PROVIDED UNDER THIS WARRANTY IS THE PURCHASER'S SOLE AND EXCLUSIVE REMEDY.

Limitation of Liability

HORIZON SHALL NOT BE LIABLE FOR SPECIAL, INDIRECT, INCIDENTAL OR CONSEQUENTIAL DAMAGES, LOSS OF PROFITS OR PRODUCTION OR COMMERCIAL LOSS IN ANY WAY, REGARDLESS OF WHETHER SUCH CLAIM IS BASED IN CONTRACT, WARRANTY, TORT, NEGLIGENCE, STRICT LIABILITY OR ANY OTHER THEORY OF LIABILITY, EVEN IF HORIZON HAS BEEN ADVISED OF THE POSSIBILITY OF SUCH DAMAGES. Further, in no event shall the liability of Horizon exceed the individual price of the Product on which liability is asserted. As Horizon has no control over use, setup, final assembly, modification or misuse, no liability shall be assumed nor accepted for any resulting damage or injury. By the act of use, setup or assembly, the user accepts all resulting liability. If you as the purchaser or user are not prepared to accept the liability associated with the use of the Product, purchaser is advised to return the Product immediately in new and unused condition to the place of purchase.

Law

These terms are governed by Illinois law (without regard to conflict of law principals). This warranty gives you specific legal rights, and you may also have other rights which vary from state to state. Horizon reserves the right to change or modify this warranty at any time without notice.

WARRANTY SERVICES

Questions, Assistance, and Services

Your local hobby store and/or place of purchase cannot provide warranty support or service. Once assembly, setup or use of the Product has been started, you must contact your local distributor or Horizon directly. This will enable Horizon to better answer your questions and service you in the event that you may need any assistance. For questions or assistance, please visit our website at www.horizonhobby.com, submit a Product Support Inquiry, or call the toll free telephone number referenced in the Warranty and Service Contact Information section to speak with a Product Support representative.

Inspection or Services

If this Product needs to be inspected or serviced and is compliant in the country you live and use the Product in, please use the Horizon Online Service Request submission process found on our website or call Horizon to obtain a Return Merchandise Authorization (RMA) number. Pack the Product securely using a shipping carton. Please note that original boxes may be included, but are not designed to withstand the rigors of shipping without additional protection. Ship via a carrier that provides tracking and insurance for lost or damaged parcels, as Horizon is not responsible for merchandise until it arrives and is accepted at our facility. An Online Service Request is available at http://www.horizonhobby.com/content/service-center_render-service-center. If you do not have internet access, please contact Horizon Product Support to obtain a RMA number along with instructions for submitting your product for service. When calling Horizon, you will be asked to provide your complete name, street address, email address and phone number where you can be reached during business hours. When sending product into Horizon, please include your RMA number, a list of the included items, and a brief summary of the problem. A copy of your original sales receipt must be included for warranty consideration. Be sure your name, address, and RMA number are clearly written on the outside of the shipping carton.

NOTICE: Do not ship LiPo batteries to Horizon. If you have any issue with a LiPo battery, please contact the appropriate Horizon Product Support office.

Warranty Requirements

For Warranty consideration, you must include your original sales receipt verifying the proof-of-purchase date. Provided warranty conditions have been met, your Product will be serviced or replaced free of charge. Service or replacement decisions are at the sole discretion of Horizon.

Non-Warranty Service

Should your service not be covered by warranty, service will be completed and payment will be required without notification or estimate of the expense unless the expense exceeds 50% of the retail purchase cost. By submitting the item for service you are agreeing to payment of the service without notification. Service estimates are available upon request. You must include this request with your item submitted for service. Non-warranty service estimates will be billed a minimum of ½ hour of labor. In addition you will be billed for return freight. Horizon accepts money orders and cashier's checks, as well as Visa, MasterCard, American Express, and Discover cards. By submitting any item to Horizon for service, you are agreeing to Horizon's Terms and Conditions found on our website http://www.horizonhobby.com/content/service-center_render-service-center.

ATTENTION: Horizon service is limited to Product compliant in the country of use and ownership. If received, a non-compliant Product will not be serviced. Further, the sender will be responsible for arranging return shipment of the un-serviced Product, through a carrier of the sender's choice and at the sender's expense. Horizon will hold non-compliant Product for a period of 60 days from notification, after which it will be discarded.

10/15

WARRANTY AND SERVICE CONTACT INFORMATION

Country of Purchase	Horizon Hobby	Contact Information	Address
United States of America	Horizon Service Center (Repairs and Repair Requests)	servicecenter.horizonhobby.com/RequestForm/	2904 Research Road Champaign, IL 61822
	Horizon Product Support (Product Technical Assistance)	productsupport@horizonhobby.com 877-504-0233	
	Sales	websales@horizonhobby.com 800-338-4639	
European Union	Horizon Technischer Service	service@horizonhobby.eu	Hanskampring 9 D 22885 Barsbüttel, Germany
	Sales: Horizon Hobby GmbH	+49 (0) 4121 2655 100	

INSTRUCTIONS FOR DISPOSAL OF WEEE BY USERS IN THE EUROPEAN UNION



This product must not be disposed of with other waste. Instead, it is the user's responsibility to dispose of their waste equipment by handing it over to a designated collections point for the recycling of waste electrical and electronic equipment. The separate collection and recycling of your waste equipment at the time of disposal will help to conserve natural resources and ensure that it is recycled in a manner that protects human health and the environment. For more information about where you can drop off your waste equipment for recycling, please contact your local city office, your household waste disposal service or where you purchased the product.

EU Manufacturer of Record:

Horizon Hobby, LLC
2904 Research Road
Champaign, IL 61822 USA

EU Importer of Record:

Horizon Hobby GmbH,
Hanskampring 9
D 22885 Barsbüttel, Germany



E328

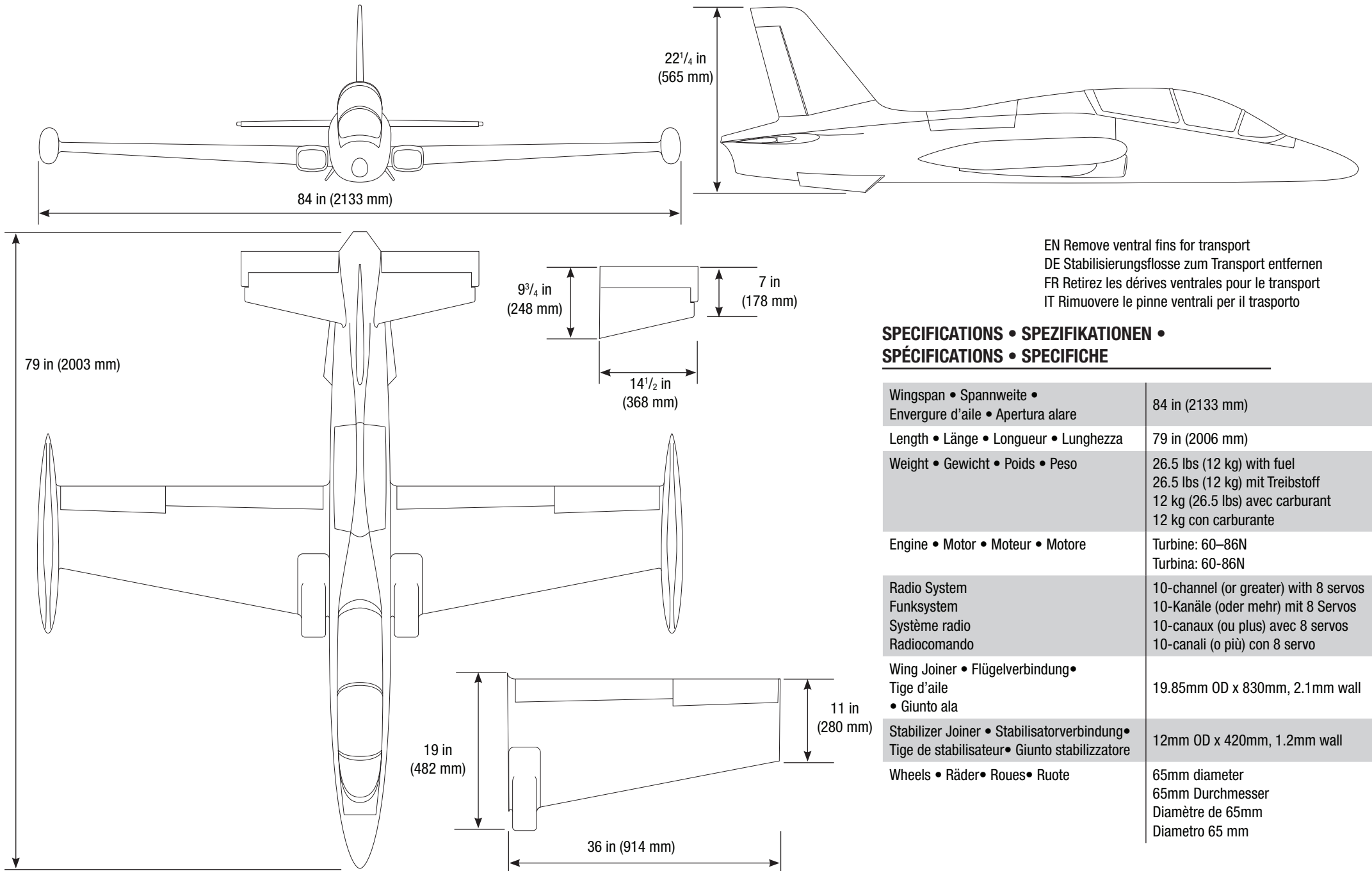

EN Remove ventral fins for transport
 DE Stabilisierungsflosse zum Transport entfernen
 FR Retirez les dérives ventrales pour le transport
 IT Rimuovere le pinne ventrali per il trasporto

**SPECIFICATIONS • SPEZIFIKATIONEN •
 SPÉCIFICATIONS • SPECIFICHE**

Wingspan • Spannweite • Envergure d'aile • Apertura alare	84 in (2133 mm)
Length • Länge • Longueur • Lunghezza	79 in (2006 mm)
Weight • Gewicht • Poids • Peso	26.5 lbs (12 kg) with fuel 26.5 lbs (12 kg) mit Treibstoff 12 kg (26.5 lbs) avec carburant 12 kg con carburante
Engine • Motor • Moteur • Motore	Turbine: 60–86N Turbina: 60-86N
Radio System Funksystem Système radio Radiocomando	10-channel (or greater) with 8 servos 10-Kanäle (oder mehr) mit 8 Servos 10-canaux (ou plus) avec 8 servos 10-canali (o più) con 8 servo
Wing Joiner • Flügelverbindung • Tige d'aile • Giunto ala	19.85mm OD x 830mm, 2.1mm wall
Stabilizer Joiner • Stabilisatorverbindung • Tige de stabilisateur • Giunto stabilizzatore	12mm OD x 420mm, 1.2mm wall
Wheels • Räder • Roues • Ruote	65mm diameter 65mm Durchmesser Diamètre de 65mm Diametro 65 mm



© 2024 Horizon Hobby, LLC.

Hangar 9, AS3X, Avian, IC3, and the Horizon Hobby logo are trademarks or registered trademarks of Horizon Hobby, LLC.

The Spektrum trademark is used with permission of Bachmann Industries, Inc.

All other trademarks, service marks and logos are the property of their respective owners.

Updated 04/2024

793434 HAN3390B