

ORION

2.4GHz RTR RACE-READY SAILBOAT



SPECIFICATIONS:

- Total length: 465mm
- Beam: 150mm
- Mast height: 637mm
- Overall height: 920mm
- Sail area (main): 7.39 dm²
- Sail area (jib): 3.78 dm²
- Sail area (overall): 11.17 dm²
- Fiberglass pipe mast and booms
- Zinc alloy ballast and ABS keel
- Plastic molded boat stand
- Servo: 37g standard sail servo and 9g rudder servo
- 2.4GHz 2CH digital proportional radio control system
- Hull material: plastic molded hull (decal stickers and painting)
- RTR total weight: 950g

INSTRUCTION MANUAL THIS MODEL IS NOT A TOY!

THESE INSTRUCTIONS SHOULD BE READ BY A SUPERVISING ADULT

2.4GHz RTR ORION V2 RACE-READY SAILBOAT

Model No:8803V2

IMPORTANT :

1. This is not a toy. Assembly and operating of this boat requires adult supervision.
2. Please take time to read the instructions carefully and completely before attempting to operate your model.
This manual contains the instructions you need to safely build, operate and maintain your R/C sailboat.

CONTENTS OF SET



Main & Jib sails



Hull installed with servos & battery box



2.4GHz 2CH Digital Proportional Transmitter



rudder



keel



ballast



Masthead swivel with "S" hook



boat stand



two pcs of M4 nuts



2pcs "S" hook



Dyneema Cord



Long mast



Main Boom & Jib Boom



Forestay fitting tube



Mast fitting tube



Short mast



Rudder arm set



1.5mm Allen Key



2.5mm Allen Key



Cloth Deck Patch



Metal backstay crane



Cord bowsie



slot-head screwdriver (not included)

ITEMS REQUIRED FOR COMPLETION

- 4 x "AA" alkaline batteries for transmitter (not included)
- 4 x "AA" alkaline batteries for receiver (not included)

SPARE PART LIST

To order ORION V2 spare parts, use the part numbers in the spare parts list that follows.

PART NO.	DESCRIPTION
880304	ABS keel with screws
880305	360g standard ballast
880306	Standard mast set
880307	Jib boom & fitting
880308	Main boom kicker assembly & fittings
880311	Sail servo and servo arm
880312	9g rudder servo
880313	Servo plastic tray
880314	Pushrod with rubber bellow
880315	Switch rod w/ rubber bellow & switch connector set
880316	Rudder
880318	J2C03 Transmitter and receiver set
880319	Plastic molded boat stand
880321	Cloth deck patch (PK4)
880322	Orion V2 hull with black color painting(no decals)
880323	Orion V2 decal stickers
880324	Orion V2 standard sails set
880505	Fin box and mast fitting
880510	Sheeting pulley block
880511	1m Sheeting elastic
880516	Receiver
880519	Winch line rubber cap (pk2)
880529	Masthead fitting
880532	Deck eyes (PK10)
880533	Mainsail luff rings (pk10)
880535	Aluminum alloy rudder arm set
880536	Rubber bung (PK4)
880537	Jib boom counterbalance weight (PK4)
881507	5m dyneema cord white
881538	Molded black color silicone tube (Pk20)
881210	Bowsie(PK10)

ORION BOAT STAND ASSEMBLY STEPS

Take boat stand fittings out of box and assemble them as photos shown.

1. Insert two ABS pipes into one under boat stand as photo 1 shown.
2. Join one upper boat stand and one under boat stand together with two assembled ABS pipes as photo 2 shown.
3. Insert two lateral ABS pipes into already assembled boat stand respectively as photo 3 shown.

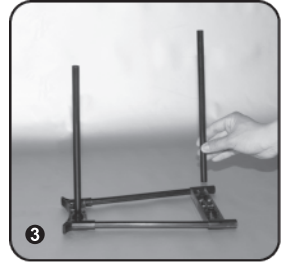
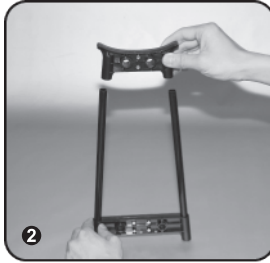
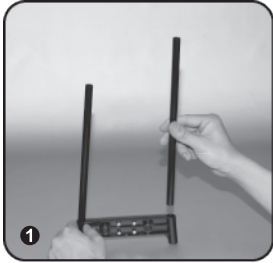

4. Assemble the other boat stand the same way as step 1 and step 2.
5. Interlink two assembled boat stands well as photo 4 shown.
6. Stick two included EVA to two upper boat stands as photo 5 shown, photo 6 is the assembled completely boat stand

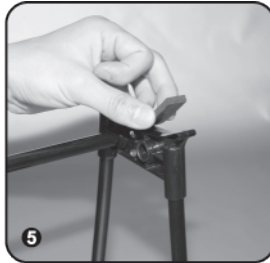
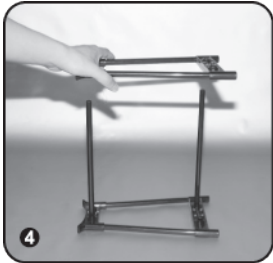

KEEL & BALLAST & RUDDER ASSEMBLY

Take the keel, ballast and rudder out of box and assemble them as photos shown.

1. Secure keel and ballast with M4 nut and screw driver.
2. Secure keel and hull with M4 nut and screw driver.
3. Insert the rudder shaft up through the bottom of the stern of hull. Notice the rudder's direction. Use 2.5mm allen key to secure the rudder shaft on the rudder arm. Make sure rudder can freely rotate and the gap for up and down is no more than 0.5mm;

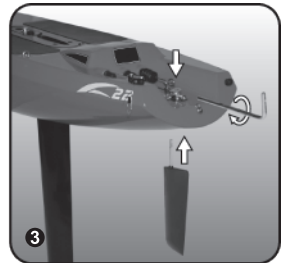
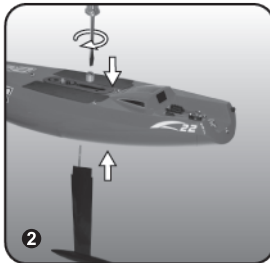
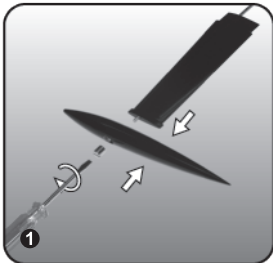

4. Pushrod go through clevis on rudder arm,make sure rudder is on the center line of hull,then use 2.5mm allen key to tighten clevis screw.



MAIN SAIL RIGGING

1. Use the cord which attached to Silicone ring "SR1" to thread through eyelet on bottom of main boom bearing from back side to front side, then through eyelet on top of main boom bearing, then through eyelet in bottom left corner of mainsail, lastly attach it to eyelet on top of main boom bearing. Keep the distance between mainsail and main boom around 10mm.
2. Use the cord which attached to Silicone ring "SR4" and through "SR5" to attach it to eyelet on bottom right corner of mainsail, notice the gap between bottom sail and boom tube is around 15mm. You could adjust the mainsail shape by moving the "SR4" position.
3. Use mast fitting tube (longer side) to thread through bearing on main boom,insert mast fitting tube in main mast mount as shown. see page 6.
4. Thread three mainsail luff rings through long mast. see page 6.
5. Insert long mast in mast fitting tube (shorter side). see page 6.
6. Thread metal backstay crane through mast head swivel and insert in short mast. Short mast joint with forestay fitting tube. see page 6.
7. Insert short mast with forestay fitting tube into long mast. see page 6.
8. Use S hook on mast head swivel to attach eyelet on mainsail tip. see page 6.
9. Cut a length of Dyneema cord at around 1000mm,attach it to metal backstay crane eyelet, the other end of cord thread through a bowsie's two holes in proper order, through stern S hook then attach cord to the end eyelet of bowsie. adjust cord bowsie to pull cord tight and straight. see page 6.
10. Move silicone ring "SR1" on main boom to pull main sail tight. you could adjust the mainsail shape by moving silicone ring "SR5" on main boom. Use 1.5mm allen key to rotate the brass compression strut to adjust the angle between main boom and mast. So that the main boom could pull the bottom right corner of mainsail tight. But remember not to pull mainsail too tight. see page 6.

MAIN BOOM RIGGING

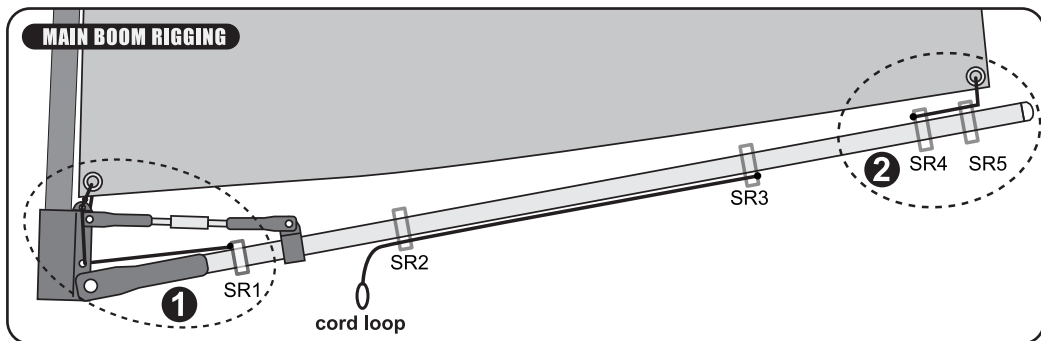

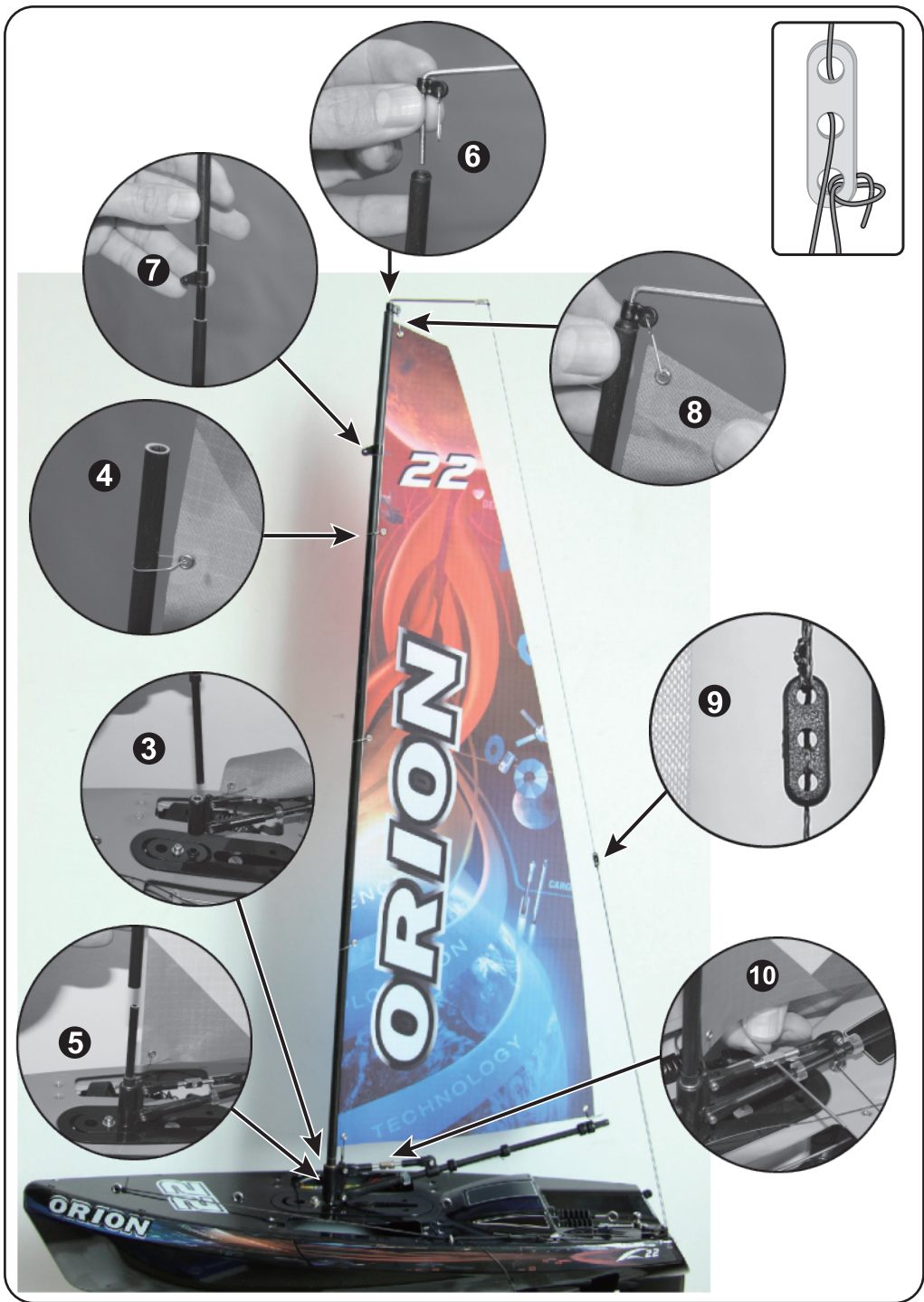

JIB BOOM RIGGING

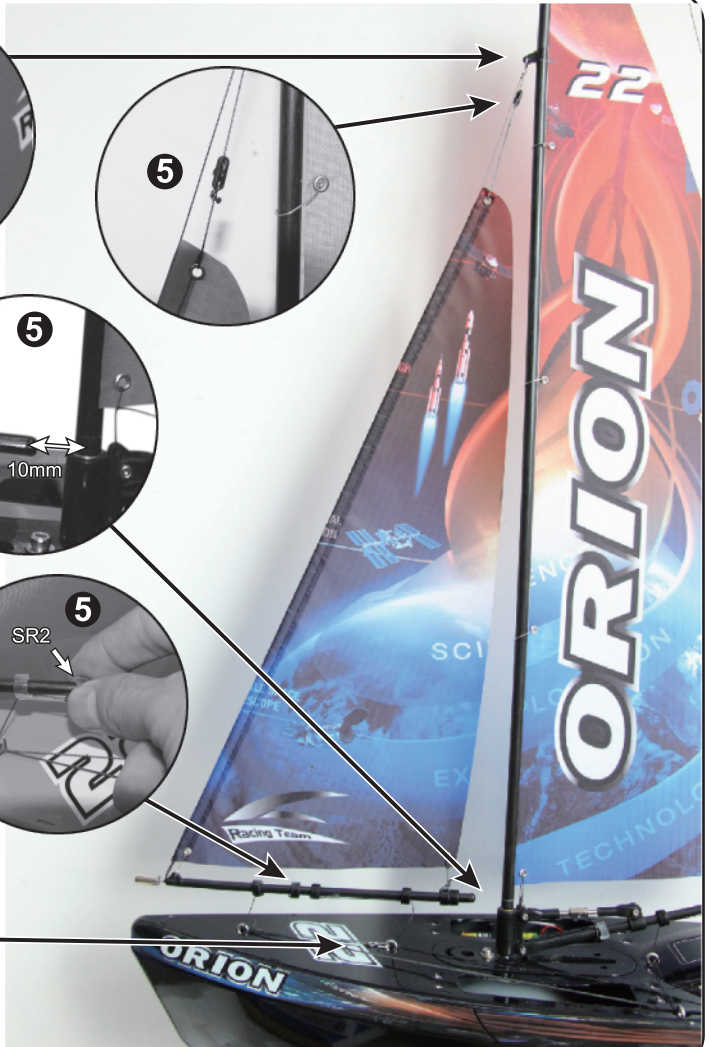
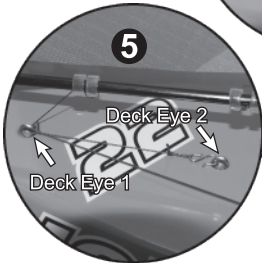
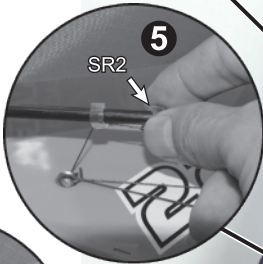
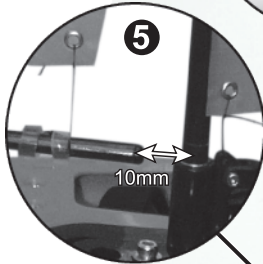
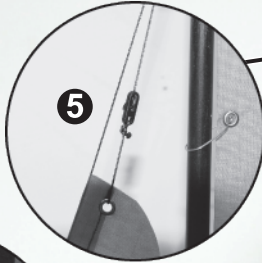
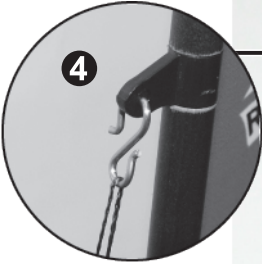

1. Use forestay cord loop to loop around jib weight shaft.
2. Use "S"hook to attach to eyelet in bottom left corner of jib sail.
3. Use the cord which attached to silicone ring "SR5" and through "SR6" to attach it to eyelet on bottom right corner of jibsail. notice the gap between bottom sail and boom tube is around 10mm. You could adjust the jibsail shape by moving the "SR5" position.
4. Use S hook which is supplied in tool bag to attach the forestay cord with eyelet in forestay fitting.
5. There is cord which is already attached to silicone ring "SR2" on JIB BOOM and thread through silicone ring "SR1" on JIB BOOM. Use the loop on the other end of this cord to thread through DECK EYE 1, use S hook which is supplied in tool bag to attach the cord loop with DECK EYE 2. This arrangement allows rigs to be changed quickly and easily. Now adjust bowsie on forestay cord and "SR2" position on JIB BOOM to pull jib sail tight and make sure jib boom end is around 10mm distance to mast.
6. You could adjust the JIB SAIL shape by moving silicone ring "SR6" on JIB BOOM.

INSTALL 4 PCS "AA" ALKALINE BATTERIES IN YOUR TRANSMITTER

Install two control sticks before installing 4 pcs "AA" batteries.



Always use fresh AA alkaline battery in the transmitter.

1. Ensure transmitter "POWER" switch is in the off position.
2. Slide off the battery door on the back of the transmitter.
3. Install 4 fresh "AA" alkaline batteries into the molded battery compartment of transmitter. Noting correct location (polarity + or -)
4. Re-install the battery door onto the back of transmitter.

IMPORTANT NOTE: It is very important to keep the throttle stick at its lowest position before switch on transmitter.

So that when you install batteries for receiver, radio and boat are activated only on the condition that throttle stick is at its lowest position.

5. Switch "POWER" on, green indicator light is on. Otherwise, check the above processes again to reinstall batteries.



INSTALL 4 PCS "AA" ALKALINE BATTERIES IN RECEIVER

IMPORTANT NOTE: Always switch on the transmitter before switch on the receiver and always switch off the receiver before switch off the transmitter.

Install 4 AA alkaline batteries into battery box of Orion:

1. Push down the throttle stick (left stick) to the lowest position as shown, then switch on the transmitter;
2. Take battery box out of hull.

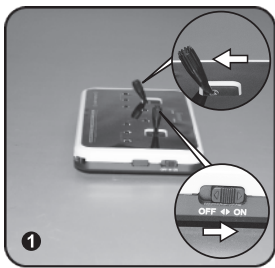

3. Install 4 pieces of "AA" Alkaline batteries into the the receiver box,make sure the correct polarity,then reposition the battery box into the original position and fix it tightly again with velcro strap.
4. Switch on the receiver by pushing the pushrod forward to position "on". This moment the receiver green light will be on,and steering servo and sailing servo in boat are under control correspondingly of radio control.

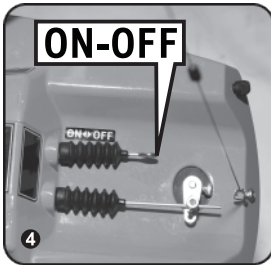
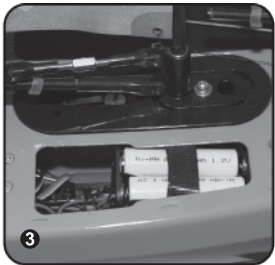

MAIN BOOM & JIB BOOM RIGGING

1. Now sail control stick (left stick) push down till the end, the sail servo pull cord tight. Pull out Switch rod to switch off receiver and switch off transmitter as well.
2. Use cord loop on MAIN BOOM to thread through DECK EYE 3, DECK EYE 4 then attach to CLIP. Make sure MAIN BOOM is pulled as on the centerline of hull. If not, adjust silicone ring "SR2" and "SR3" to pull MAIN BOOM tight.
3. Use cord loop on JIB BOOM to thread through DECK EYE 2 then attach to CLIP. Adjust silicone ring "SR3" and "SR4" on JIB BOOM to make sure rear-end of JIB BOOM is moved away from MAST at 25mm-30mm.
4. Lastly stick the two pcs of cloth material deck patch to seal the deck on hull.

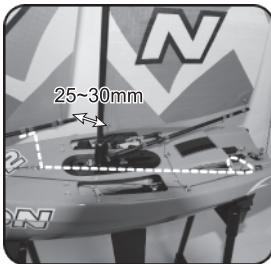
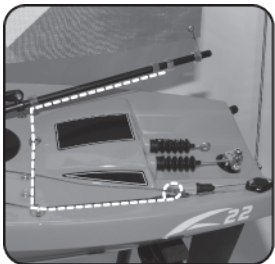

IMPORTANT NOTE:

Always keep the cloth deck patch clean when you peel off the patch to exchange batteries. If you use the deck patch properly, it can be reused many times and can seal well the deck to keep hull watertight. If found the deck patch not sealable after many times use, please purchase new deck patch replacement (Part No.#880321)

TRANSMITTER & RECEIVER BINDING

The binding process effectively ties the transmitter and receiver together. Under normal circumstances, both items are supplied like this from the factory. If, however, you find that your transmitter and receiver are not bound (receiver's red LED will turn on), you should do the following:

1. Make sure throttle stick (Left Stick) is pushed down till the end, switch on transmitter.
2. Take receiver battery box out of hull, install 4 pieces of "AA" batteries into battery box in correct polarity, then locate back battery box and fix it well with velcro strap.
3. Switch on the receiver by pushing the pushrod forward to position "on".
4. Press down the "BIND" button on the receiver and release, the receiver's green light will flash and then turn to solid on, this indicate that binding process has been operated successfully and the receiver will now accept commands from the transmitter.

Note: During binding process, transmitter and receiver should be no more than one meter apart and no other similar devices should be within 10 meters. If the receiver's GREEN light is flashing, indicating a binding failure, Please repeat the binding process above.

PREPARATIONS FOR SAILING

Before sailing your ORION for the first time, Always switch on the transmitter before switch on the receiver and always switch off the receiver before switch off the transmitter.

Following the procedures to check the radio and sailboat's function:

1. ORION is supplied with 2.4GHz 2CH radio system. Please see following function of the transmitter.
2. For sail control stick, when stick is in position A, accordingly, the main boom and jib boom are in the position of A as shown. When stick is in the position of B, accordingly, the main boom and jib boom are in the position of B as shown.
3. You may also adjust the sail servo neutral by pressing the sail neutral position trim button up or down.
4. For rudder control stick, rudder turn left when rudder control stick is pushed to the left. Rudder turn right when rudder control stick is pushed to the right.
5. You may also adjust the rudder servo neutral by pressing the rudder neutral position trim button left or right.

TRANSMITTER & RECEIVER BINDING

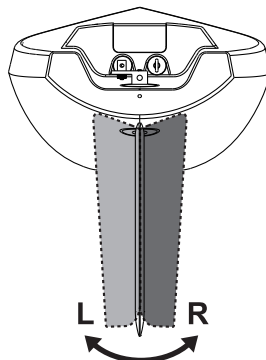
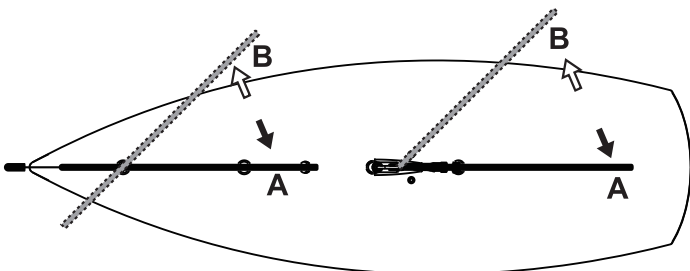
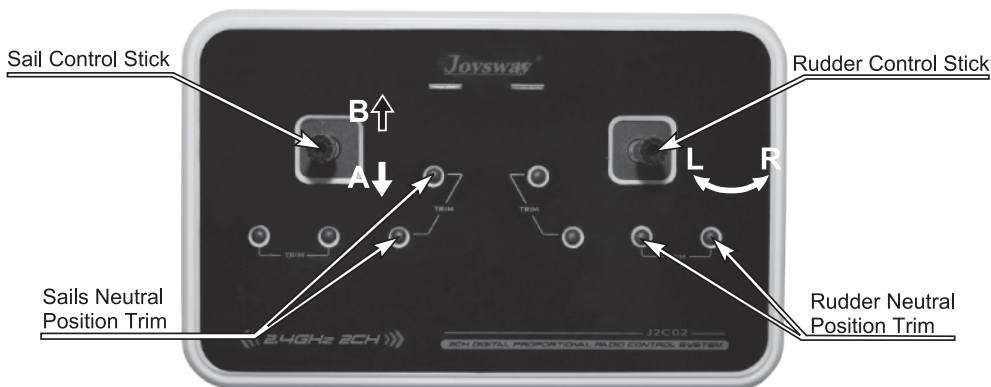

SAILING THE ORION

Unlike propeller driven boats that you basically point and accelerate, sailboats present an interesting challenge. Sailing requires constant reaction to water movements, any wind gusts, and any wind direction changes. These reactions then require adjustment of the rudder and sails in order to find the best possible course. There is no substitute for actual "on-the-water" experience and after your first couple of outings you may want to read through this manual again in order to help you to gain a better understanding of the "art" of sailing. While learning to sail, it is a good idea to pick up on as much sailing terminology as possible. This will make it easier to grasp some aspects.

How To Sail ORION

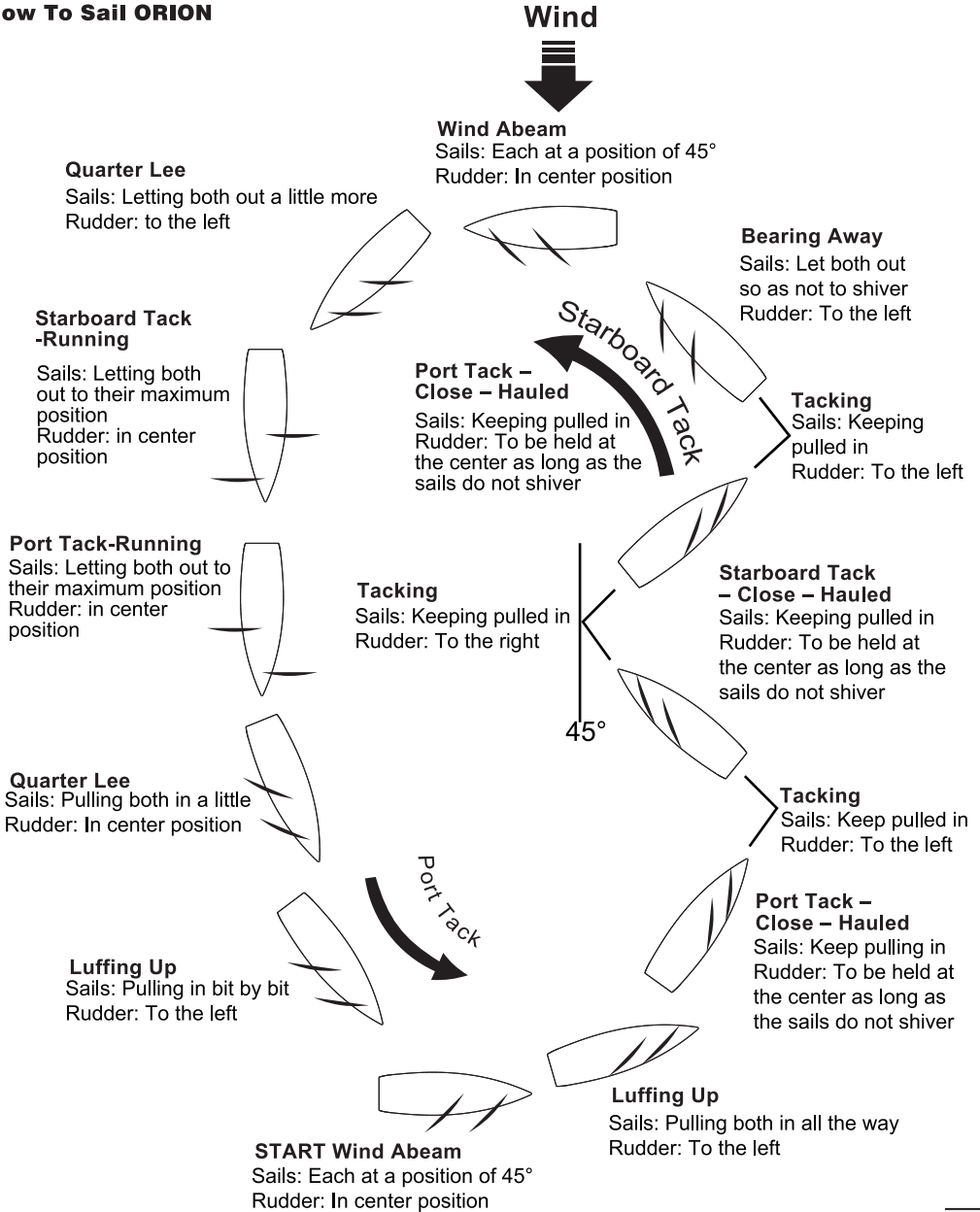

IMPORTANT NOTICE:

1. Sail your ORION only in still bodies of water. Never sail your boat in running water such as streams or rivers, as it is easy to lose control of your boat.
2. Do not sail ORION in heavy winds.
3. Never attempt to swim after a stalled or stuck boat! Wait patiently for the wind currents to return the boat to shore.
4. After running, remove the deck and allow the interior of the boat to dry out completely. If you neglect to do this, it may result in corrosion of the electronic components.



FCC REQUIREMENT



This device complies with Part 15 of the FCC Rules. Operation is subject to the following two conditions: (1) This device may not cause harmful interference, and (2) This device must accept any interference received, including interference that may cause undesired operation.

CAUTION: Changes or modifications to this product not expressly approved by the party responsible for compliance may void the user's authority to operate the equipment.