

TRAIL PROVEN OFF-ROAD PERFORMANCE

SCX10™

SCX10 II™ TRAIL HONCHO

1/10th SCALE ELECTRIC 4WD - READY TO RUN



www.axialracing.com



AXIAL BUMPER TO BUMPER ONE (1) YEAR LIMITED WARRANTY

Axial's warranty center, Hobby Services, guarantees this kit to be free from defects in materials and workmanship for one (1) year from the date of purchase. Axial will repair or replace, at the discretion of Hobby Services, Axial will repair or replace any incorrectly made part. Your receipt or invoice at the time of purchase is your proof of purchase and is required for Axial to honor any warranty. Axial reserves the right to change or modify this warranty without notice. This warranty does not cover damages due to normal wear and tear, users' failure to perform routine maintenance, user error of assembly or installation, modifications, misuse, crash damage or the addition of aftermarket parts or optional parts.

Repair or replacement of the product by Hobby Services is the sole and exclusive remedy for any loss or damages.

Neither Axial nor Hobby Services are liable under this limited warranty for any incidental, consequential, indirect or special damages, including without limitation, loss of profits or other economic damages.

Note: Purchasing products from unauthorized retailers may void the warranty and prevent support and service.

INTERNATIONAL CUSTOMER WARRANTY

Please contact the dealer where the purchase was made. If your Axial product purchase was made through an on-line retailer, any warranty issues must be taken care of by that retailer. Axial assumes no responsibility for Axial products sold internationally by on-line retailers outside of your home country/region.

SPECIFICATIONS & DESCRIPTION CHANGES

All information found in this manual is subject to change without notice. Visit Axialracing.com for the latest updates and information regarding your model. Axial maintains no responsibility for inadvertent errors in this manual or on the box art.

WARRANTY REPAIRS CONTACT

Hobby Services
3002 N. Apollo Drive Suite 1
Champaign, IL 61822
ATTN: Service Department
Phone: 877-64-AXIAL (877-642-9425)
8:00 am – 5:00 pm Central Time M-F
E-mail: service@axialracing.com

CAUTIONS



To prevent serious personal injury and/or property damage, operate all remotely controlled models in a responsible manner as outlined herein.

CHOOSE THE RIGHT PLACE TO OPERATE YOUR R/C MODEL.

- Do not run on public streets or highways. This could cause serious accidents, personal injuries, and/or property damage.
- Never run R/C models near people or animals.
- To avoid injury, do not run in confined spaces.
- Do not run where loud noises can disturb others, such as hospitals and residential areas.
- Never run indoors. There is a high risk of fire and/or damage.

INSPECT YOUR MODEL BEFORE OPERATION.

- Make sure that all screws and nuts are properly tightened. It is also a good idea to use removable thread lock wherever metal screws go into metal, especially for engine mounts and the engine pilot shaft.
- Always use fresh batteries for your transmitter and for your receiver to avoid losing control of the model.
- Always test the brakes and throttle before starting your engine to avoid losing control of the model.

AFTER OPERATION OF YOUR R/C MODEL

- Disconnect battery in vehicle first, then turn off transmitter, this will prevent runaways.
- Be careful when handling batteries, they will be hot after running.
- Replace any batteries that have been dented or have frayed wires, short circuits can cause fire.
- Be sure to keep your R/C model clean and free of excess dirt and grease, this will increase the life.

VORSICHT!



Um Verletzungen an Personen und/oder Sachschäden zu vermeiden, sollten alle ferngesteuerten Modelle sorgfältig und verantwortungsbewusst bedient werden, wie nachfolgend beschrieben.

Wählen Sie den richtigen Platz zum Fahren

- Fahren Sie niemals auf öffentlichen Straßen. Dies könnte Verkehrsunfälle, Personenschäden oder Sachschäden verursachen.
- Fahren Sie niemals in der Nähe von anderen Personen oder Tieren.
- Fahren Sie niemals auf belebten Straßen.
- Fahren Sie nie in der Nähe von Wohnhäusern oder Krankenhäusern. Der Lärm könnte andere Personen stören.
- Fahren Sie niemals in Innenräumen. Dort könnte etwas beschädigt werden.

Überprüfen Sie Ihr Modell, bevor Sie es in Betrieb nehmen.

- Gehen Sie sicher, dass alle Schrauben und Muttern festgezogen sind. Verwenden Sie überall dort Schrauben-Sicherungslack, wo Metallschrauben in ein Metallgewinde greifen, besonders bei den Motorhaltern.
- Um Störungen zu vermeiden, benutzen Sie immer voll geladene Akkus in Ihrem Sender und Empfänger.
- Bevor Sie den Motor starten, sollten Sie immer die Funktion der Bremse und des Gashebels testen.

Nach Betrieb des RC Modells:

- Zuerst den Empfänger abdrehen, dann den Sender abdrehen um unkontrolliertes Durchgehen zu vermeiden.
- Seien Sie vorsichtig mit gebrauchten Akkus, sie können nach dem Gebrauch heiß sein.
- Ersetzen Sie Akkus/Batterien die beschädigt sind oder schadhafte Kabel aufweisen, sie können Kurzschlüsse oder Feuer verursachen.
- Halten Sie Ihr Fahrzeug sauber und entfernen Sie Schmutz und Schmierfett, damit erhöhen Sie die Lebensdauer Ihres Modells.

PRECAUTIONS



Afin d'éviter toutes blessures corporelles et/ou dommages environnants, veuillez procéder en toute responsabilité comme indiqué ci-dessous

Choisir le lieu adéquat pour faire rouler votre modèle.

- Ne jamais rouler dans les rues ou sur les routes ouvertes au publique. Ceci peut provoquer de graves accidents.
- Ne jamais rouler près de personnes ou d'animaux.
- Pour éviter les blessures, ne pas rouler dans des espaces confinés.
- Ne jamais rouler où le bruit peut déranger, comme aux abords des hôpitaux ou des quartiers résidentiels.
- Ne jamais rouler à l'intérieur: les gaz d'échappement sont nocifs.

Controler votre modèle avant chaque utilisation.

- Vérifier que les vis et les écrous sont bien serrés. Il est très fortement conseillé d'utiliser du frein filet pour bloquer les vis qui sont en contact avec du métal et tout particulièrement les vis du moteur.
- Toujours utiliser des batteries bien chargées pour l'émission et la réception.
- Toujours vérifier les freins et la commande des gaz avant de démarrer.

Après l'Opération De Votre Modèle de R/C

- Le virage du récepteur premier, alors virage de l'émetteur, ceci empêchera des fugitifs.
- Faire attention en contrôlant des piles, ils auront chaud après avoir couru.
- Remplacer n'importe quelles piles qui ont été cabossées ou a éraillé des fils, les court-circuits peuvent causer le feu.
- Etre sûr de garder votre modèle de R/C nettoie et libère de terre et la graisse supplémentaires, ceci augmentera la vie.

Problem
Problem
Problème

Cause
Grund
Cause

Remedy
Lösung
Remède

Does not move
Das Auto fährt nicht
Le véhicule ne bouge pas

Batteries are not installed properly in the transmitter.
Die Batterien sitzen nicht korrekt im Sender.
Les piles ne sont pas placées correctement dans l'émetteur.

Weak or no battery in model.
Leerer oder kein Akku im Auto.
Batterie faible ou non installée

Damaged motor.
Kaputter Motor.
Moteur endommagé

Frayed or broken wiring.
Beschädigte Verkabelung.
Câble dénudé ou coupe

ESC is shut down by heat protection circuit.
Notabschaltung des Reglers wegen Überhitzung.
Le système ESC est fermé par le circuit de protection thermique.

Make sure batteries are properly installed.
Legen Sie die Batterien korrekt ein.
Positionnez correctement les piles dans l'émetteur.

Install charged battery.
Einbauen eines geladenen Akkus.
Mettez en place une batterie chargée

Replace with new motor.
Austausch durch einen neuen Motor.
Remplacez par un nouveau moteur

Splice and insulate wiring completely.
Erneuern und isolieren Sie die kaputte Stelle.
Faites une épissure et isolez complètement le câble.

Stop driving immediately, do not drive the car until the Speed Controller cools down.
Fahren Sie nicht weiter. Warten Sie bis der Fahrten regler abgekühlt ist.
Arrêtez immédiatement de conduire, ne pilotez pas la voiture tant que le contrôleur de vitesse n'a pas refroidi.

No Control.
Keine Kontrolle über das Auto
Pas de contrôle

Improper antenna on transmitter or model.
Zu kurze Antenne am Sender oder Auto.
Antenne inadéquate sur l'émetteur ou le véhicule

Weak or no batteries in transmitter or model.
Leere oder keine Batterien im Sender oder Auto.
Batterie faible ou absente dans l'émetteur ou le véhicule.

Neutral position or trim is incorrect.
Neutralposition oder Trimmung sind verstellt.
La position neutre est incorrecte ou le trim n'est pas réglé.

Are the receiver and battery connections properly connected?
Sind der Empfänger und die Batterieverbindungen ordentlich verbunden?
Son conectadas apropiadamente las conexiones del receptor y la batería?

Install charged or fresh batteries.
Einbauen voller Batterien.
Mettez des batteries rechargées ou neuves.

Fully extend antenna.
Ziehen Sie die Antenne vollständig aus.
Dépliez complètement l'antenne.

Adjust the steering trim.
Stellen Sie die Lenkungstrimmung neu ein.
Réglez le trim de direction.

Check receiver and battery connections.
Prüfen Sie Empfänger und Batterieverbindungen.
Compruebe conexiones de batería y receptor.

Steering and Throttle Function Reversed.
Lenkung und Gas funktionieren genau verkehrt herum.
Direction et accélération inverses.

Servo reverse switch is in wrong position.
Servorichtungs-Schalter ist in der falschen Position.
L'interrupteur de marche arrière du servo est dans la mauvaise position

Please check that the wires from ESC to motor are connected properly.
Bitte überprüfen Sie, ob die Kabel vom Regler zum Motor richtig sitzen.
Veillez vérifier que les fils allant de l'ESC au moteur sont correctement raccordés.

Set to correct position.
Satz, Position zu korrigieren
Vérifiez la position correcte

Check to make sure motor and ESC are properly connected.
Kontrolle sich zu vergewissern, dass Motor und ESC ordentlich verbunden sind.
Le contrôle pour assurer que le moteur et ESC est convenablement connecté.

Included items / Im Baukasten enthalten / Outils inclus dans le kit

Radio control car
Ferngesteuertes Modellauto
Voiture radio-commandée

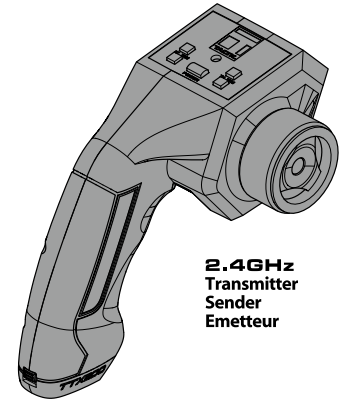
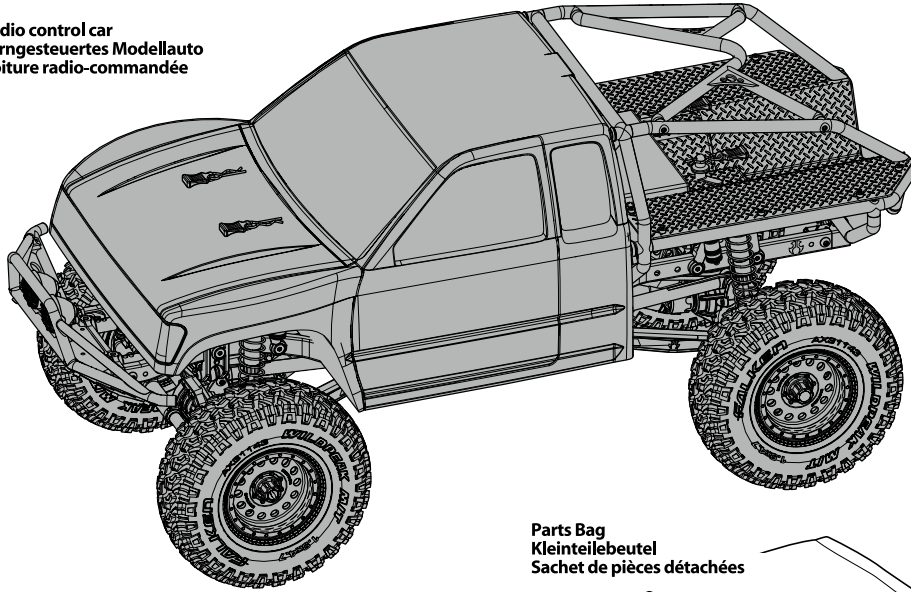

2.4GHz
Transmitter
Sender
Emetteur

Parts Bag
Kleinteilebeutel
Sachet de pièces détachées

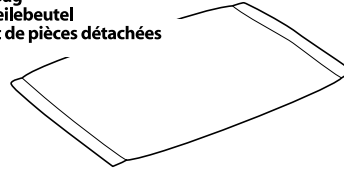

Cross wrench
Steckschlüssel
Clé à tube

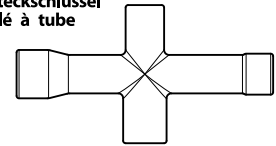

Equipment needed / Benötigtes Zubehör / Equipement nécessaire

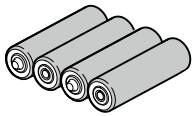

x4

4 AA Alkaline Dry Batteries.
4 St. AA Trockenbatterien.
4 piles type R6 pour votre
radio commande.

Li-Po or Ni-MH Battery Pack
Akku-Pack
Pack de batterie

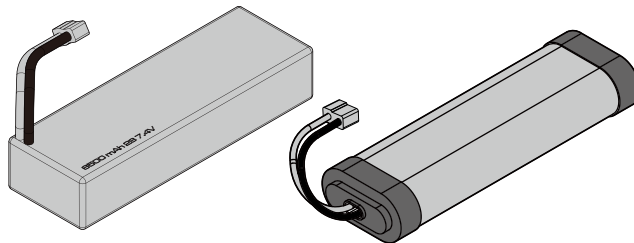

T-Style Battery Connector Required.

Charger
Ladegerät
Chargeur

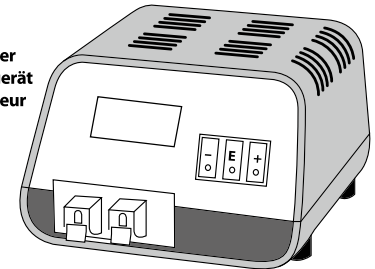

Tools Recommended / Benötigte Werkzeuge / Outillage

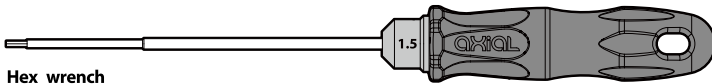

Hex wrench
Inbusschlüssel
Clé Allen

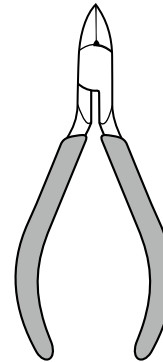
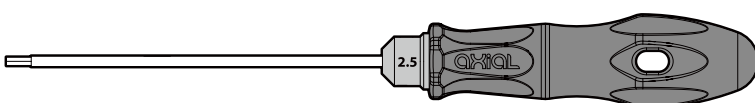
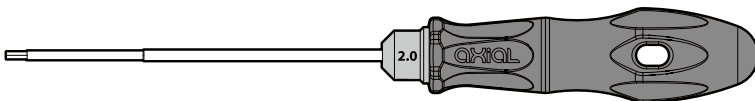

Side cutter
Seitenschneider
Pinces coupantes

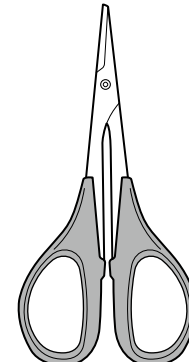

Curved scissors
Schere
Ciseaux

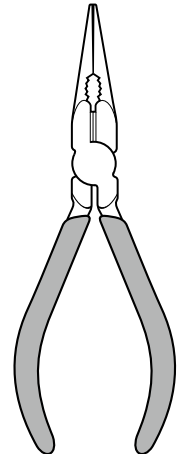

Long nose pliers
Flachzange
Pinces à becs longs

Modeling knife
Modelliermesser
Couteau de modéliste

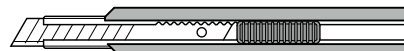

Charge your battery / Laden des Fahrakkus / Chargement de la batterie

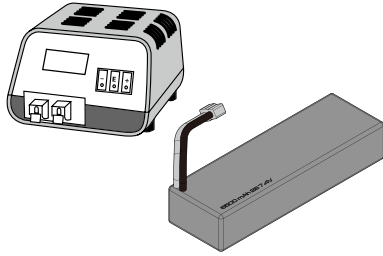

Follow the manufacturer's directions for the charger you purchased to properly charge your batteries.

Folgen Sie den Herstelleranweisungen für den Auflader Ihres gekauften ordentlich, Ihre Batterien zu laden.

Suivre les directions de fabricants pour le chargeur votre a acheté convenablement pour charger vos piles.

Make sure charger is correct for battery type selected for use. Examples: Do NOT charge Lipo batteries with Nickel Metal Hydride charger. Do NOT charge Nickel Cadmium batteries Lipo charger.

Stellen Sie sicher, Ladegerät ist korrekt für Batterietyp zur Verwendung ausgewählt. Beispiele: Laden Sie keine Lipo-Akkus mit Nickel-Metall-Hydrid-Ladegerät. Laden Sie keine Nickel-Cadmium-Akkus Lipo Ladegerät.

Assurez-vous que le chargeur est correcte pour le type de batterie sélectionné à l'emploi. Exemples: Ne pas charger les batteries Lipo avec chargeur hydrure métallique de nickel. Ne chargez pas les batteries au nickel-cadmium Lipo chargeur.

1. Turn on the transmitter.

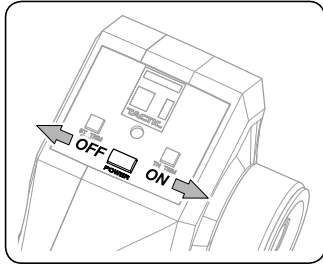

2. Remove the body clips and body. Install the battery and secure with Hook and Loop Strap.

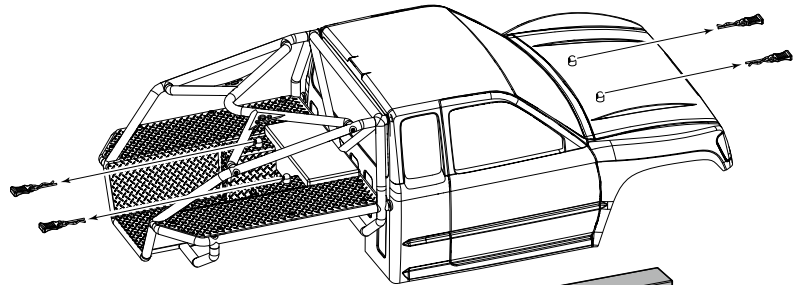

3. Connect the battery to ESC. Re-attach the body with body clips.

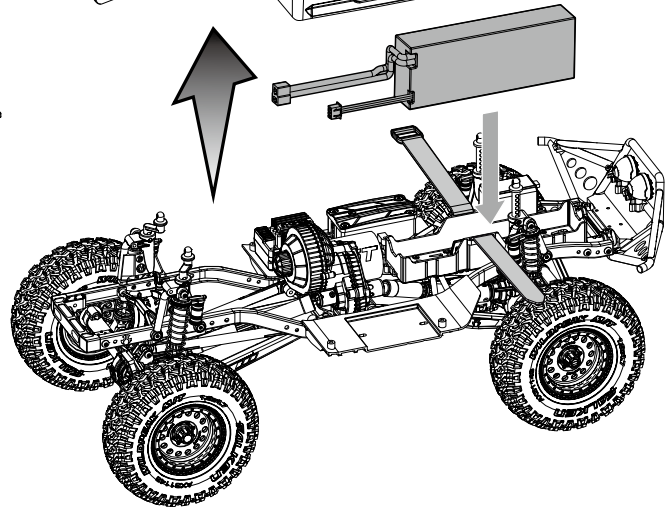
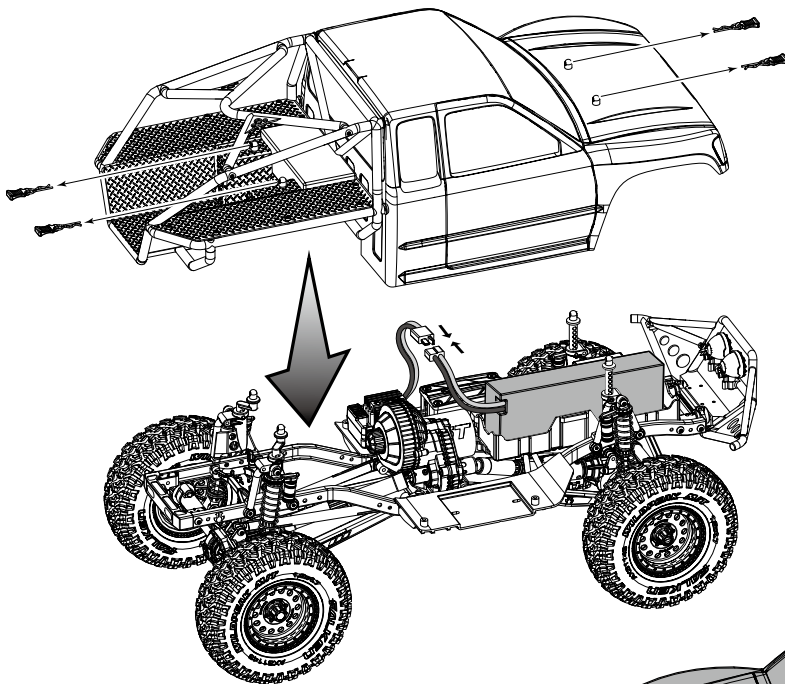

Note:
Power to the vehicle is controlled by connecting / disconnecting the battery. Always make sure to disconnect battery when not in use.

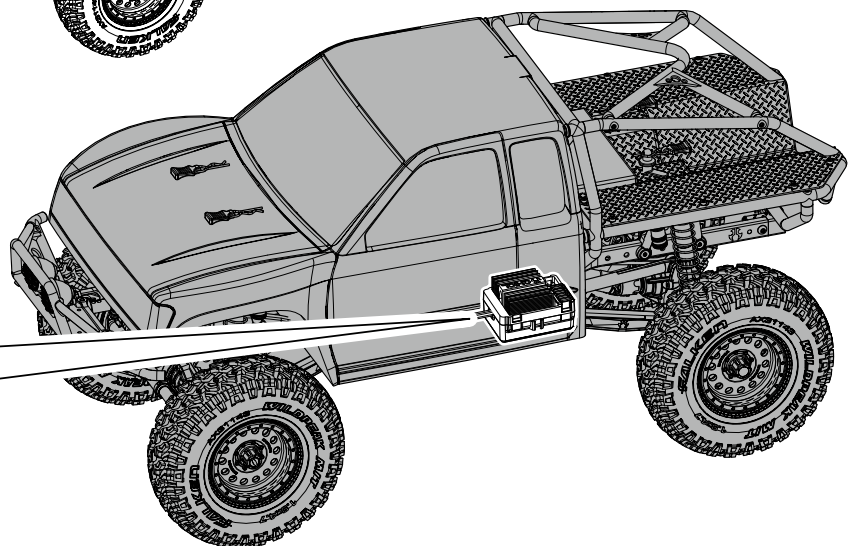
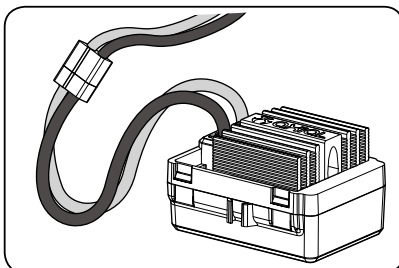

Top View Parts

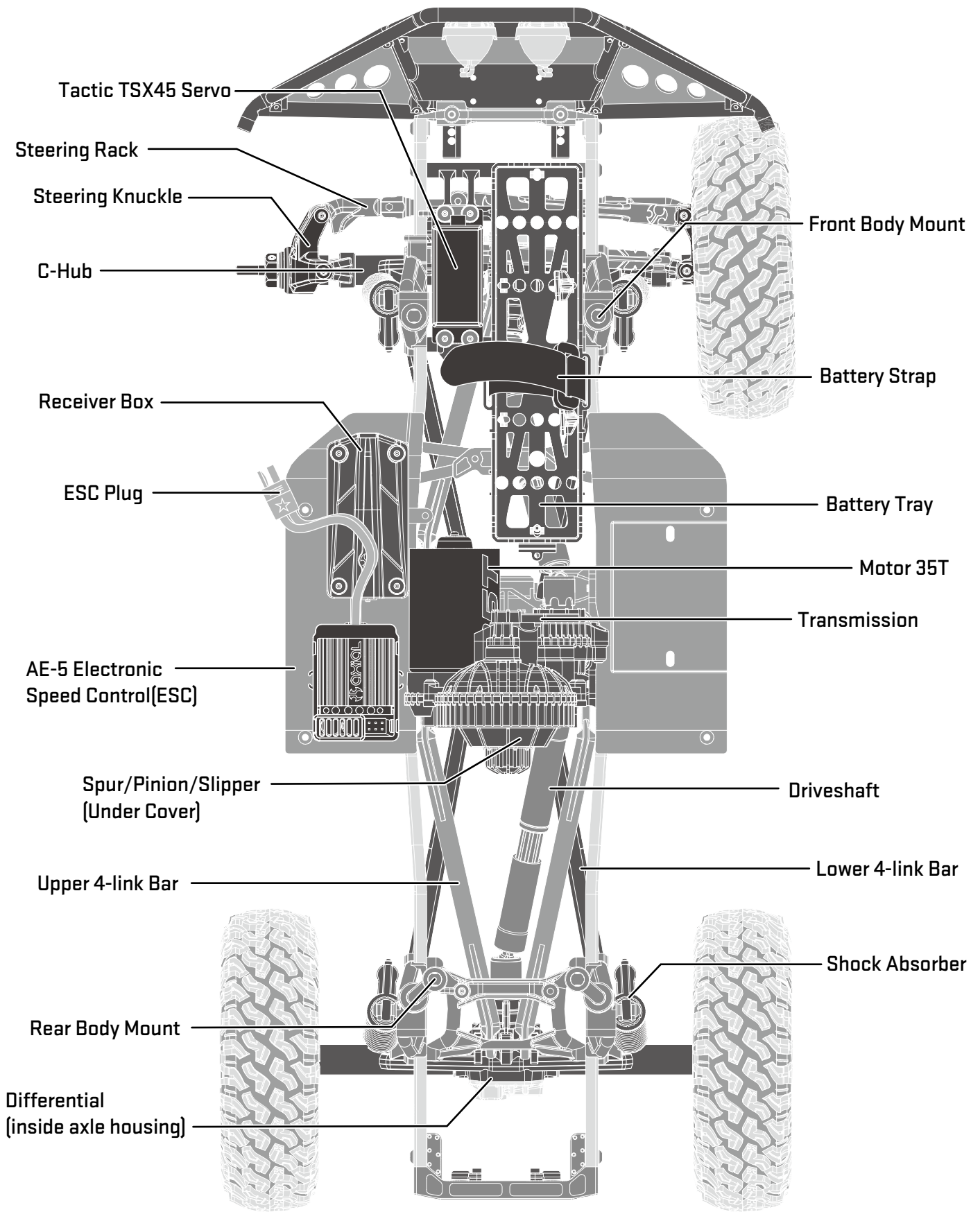

Getting-Started Checklist

The following checklist is a guide for getting you vehicle running for the first time.

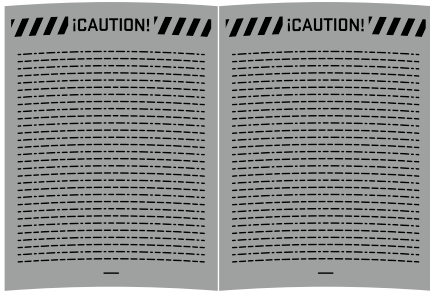

Read 'Cautions' in Manual. (Page 2)

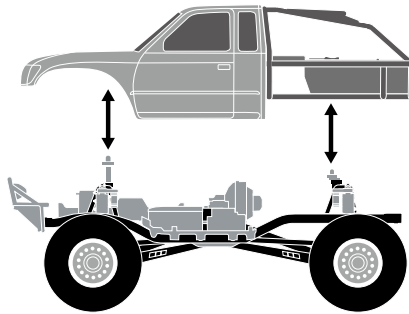

Familiarize yourself with vehicle and its components.

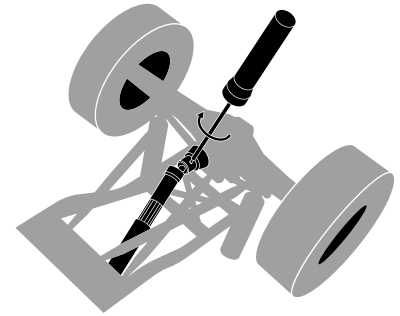

Even though the vehicle is new check driveshaft setscrews and other screws to make sure they are tight from the factory.

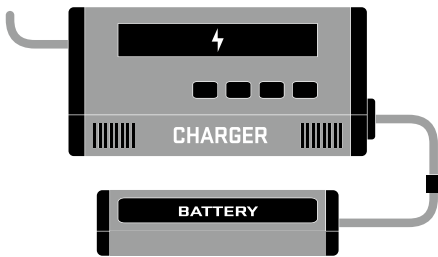

Charge battery pack. (Page 4)

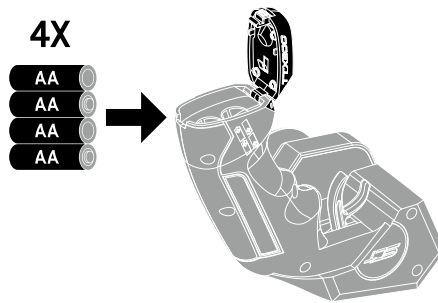

Install 4X AA batteries into Transmitter. (Page 7)

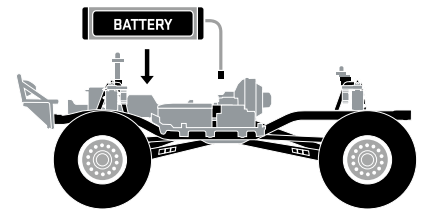

Install battery pack in vehicle. (Page 4)

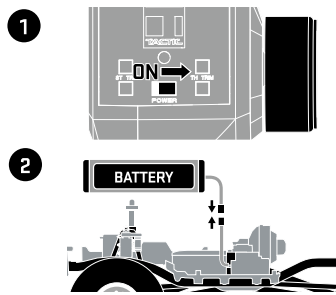

Turn on transmitter first, then plug in battery. (power ESC) (Page 4)

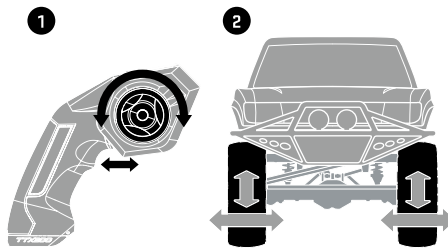

Check to make sure steering and throttle operation work correctly. (Page 7)



Range check radio system. (Page 7)

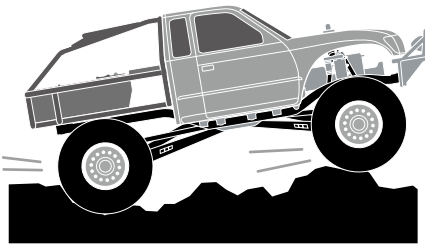

Drive vehicle, challenge yourself and have fun!

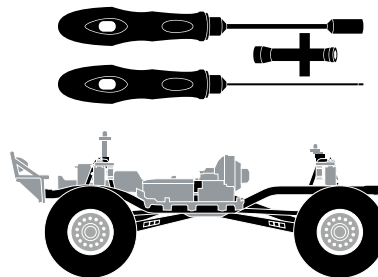

Maintain vehicle. (Page 7)

Range-Checking Your Radio System

The radio system should be checked before operating the vehicle to ensure it's operating properly and has adequate range.



1. Turn on the transmitter and then connect the battery in the vehicle.
2. Have a friend hold the vehicle while keeping hands and loose clothing away from moving parts.
3. Walk away until you are at the farthest distance you plan to operate the vehicle.
4. Steer the vehicle back and forth and throttle both forward and reverse making sure there is no erratic behavior.
5. If any erratic behavior is exhibited do not operate the vehicle, call customer service for further assistance.



RANGE-CHECKING FOR DISTANCE

Maintaining Your Vehicle

Just like a full size car or truck your RC vehicle must undergo periodic maintenance in order to ensure peak running performance. Preventative maintenance will also help avoid needless breakages which could result in costly repairs. Below are some suggestions to properly maintain your vehicle.

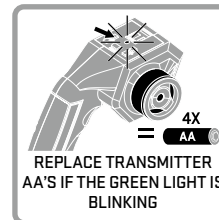
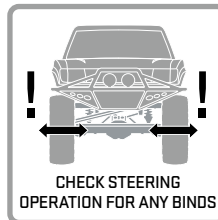
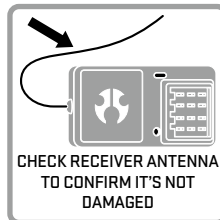
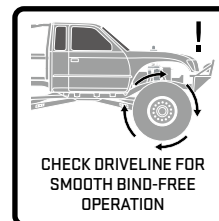
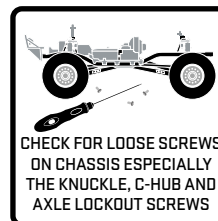
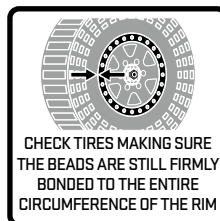
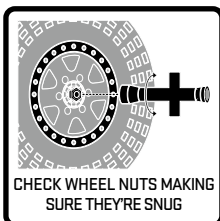
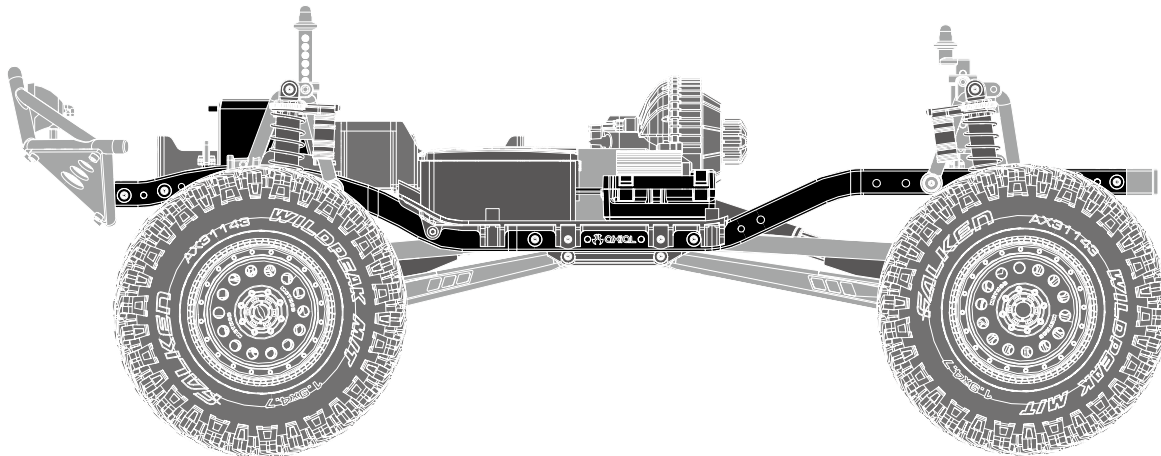
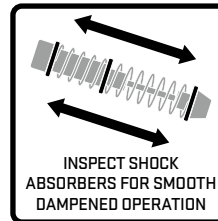
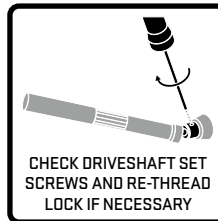
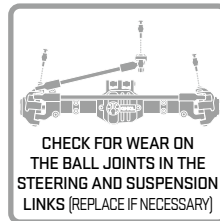
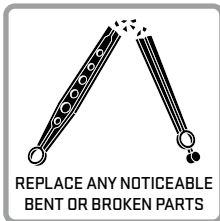

Battery Tray



AX31373
M2.6x8mm x3

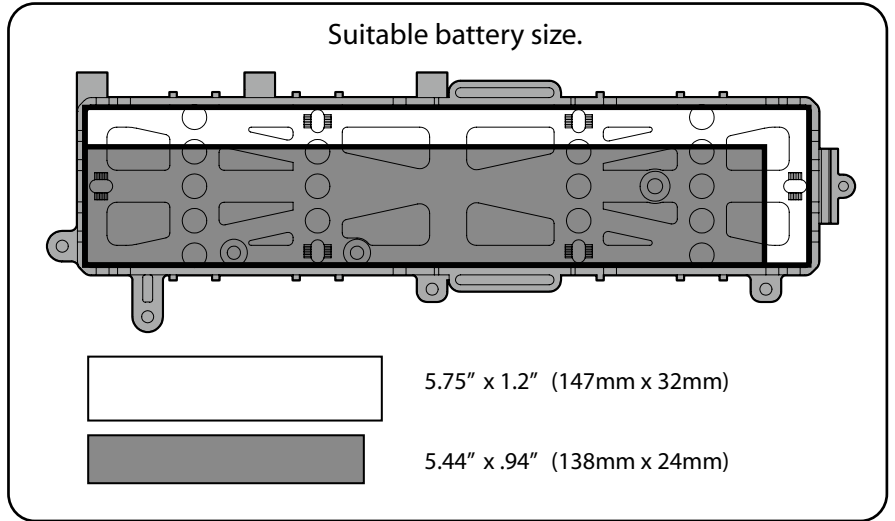
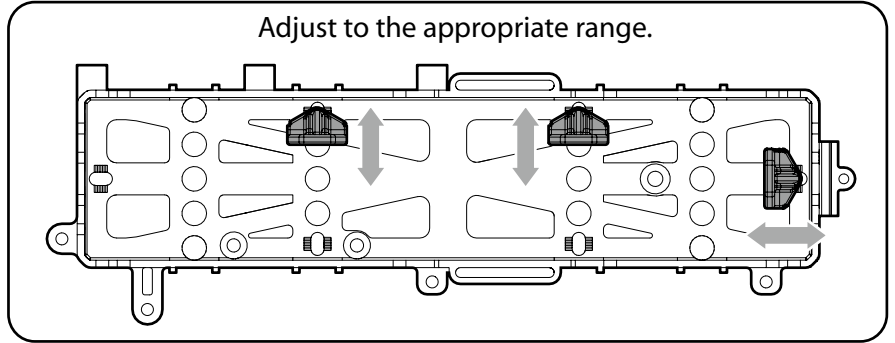
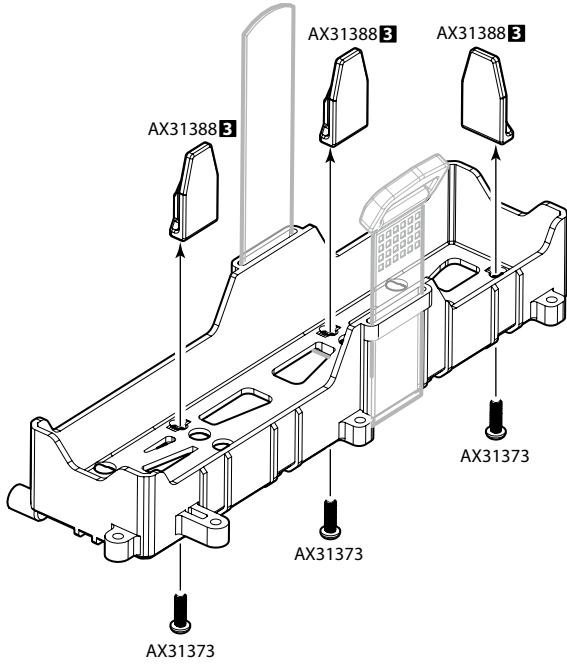

Gear Ratio / Getriebeübersetzung

SCX10 II Spur/Pinion Gear Ratio Chart - LCX Transmission							
Spur	12	13	14	15	16	17	18
56	45.50	42.00	39.00	36.40	34.13	32.12	30.33
60	48.75	45.00	41.79	39.00	36.56		

AE-5L Forward/Reverse EAS w/ Drag Brake

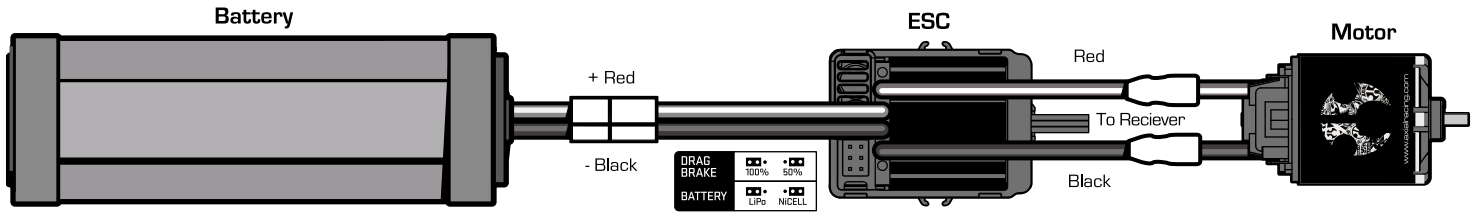

Setup:

Throttle calibration should not be needed out-of-the-box. However in order to make the throttle range of different transmitters, the calibration of the ESC is necessary:

- Mount the ESC in an area that is well ventilated and isolated from vibration and shock.
- Connect the ESC motor wires to the motor red-red & black-black.
- Plug the receiver with into the throttle channel on the receiver. The black negative wire should be towards the outside of the receiver.
- Before plugging the battery into the ESC, make sure your transmitter is on and the throttle trim is set at zero.
- Connect the battery to the ESC, this will turn on the ESC.
- Test forward and reverse control using the transmitter.
- To calibrate the ESC, make sure the transmitter is on and the throttle control is at neutral.
- Connect the battery to the ESC and wait 3 seconds to let the ESC initiate a self-test and automatic throttle calibration. When the ESC is ready to run a long beep sound will be emitted from the motor. Always disconnect the battery when the vehicle is not in use.
- Connecting the 2 LED wires to the ESC. The wires should color match.

Notes:

- Drag Brake set to 100% from the factory.
- LiPo Cut-Off is set to "ON" from the factory.

Specifications:

Input Voltage:	2-3S LiPo, 5-9 Cells NiMH/NiCd
Size:	46,5mm x 34mm x 28,5mm
Weight:	70g
Motor Limit:	12T 2S / 18T 3S
On-Resistance FET:	.002
Rated/Peak Current:	180A
Braking Current:	90A
BEC Voltage/A:	6.0V 3.0A Peak
PWM Frequency:	1KHz

Beep Sound and LED Status:

1 Short Beep:	Battery is NiMH/NiCd
2 Short Beeps:	Battery is 2S Lipo
3 Short Beeps:	Battery is 3S Lipo
1 Long Beep:	Self-test and throttle calibration is OK and ESC is ready to run



CONNECT THE BATTERY PACK JUST BEFORE DRIVING AND DISCONNECT IT IMMEDIATELY AFTER.
 ALWAYS MAKE SURE YOU ARE CONNECTING THE ESC TO A PROPER POWER SOURCE THAT HAS THE CORRECT VOLTAGE & POLARITY. INCORRECT VOLTAGES OR REVERSED POLARITY WILL DAMAGE THE ESC.
 ONCE THE BATTERY PACK IS CONNECTED, HANDLE THE MODEL WITH EXTREME CARE, MAKE SURE YOU ARE CLEAR OF ALL ROTATING PARTS.

4 LED White & Red Light String

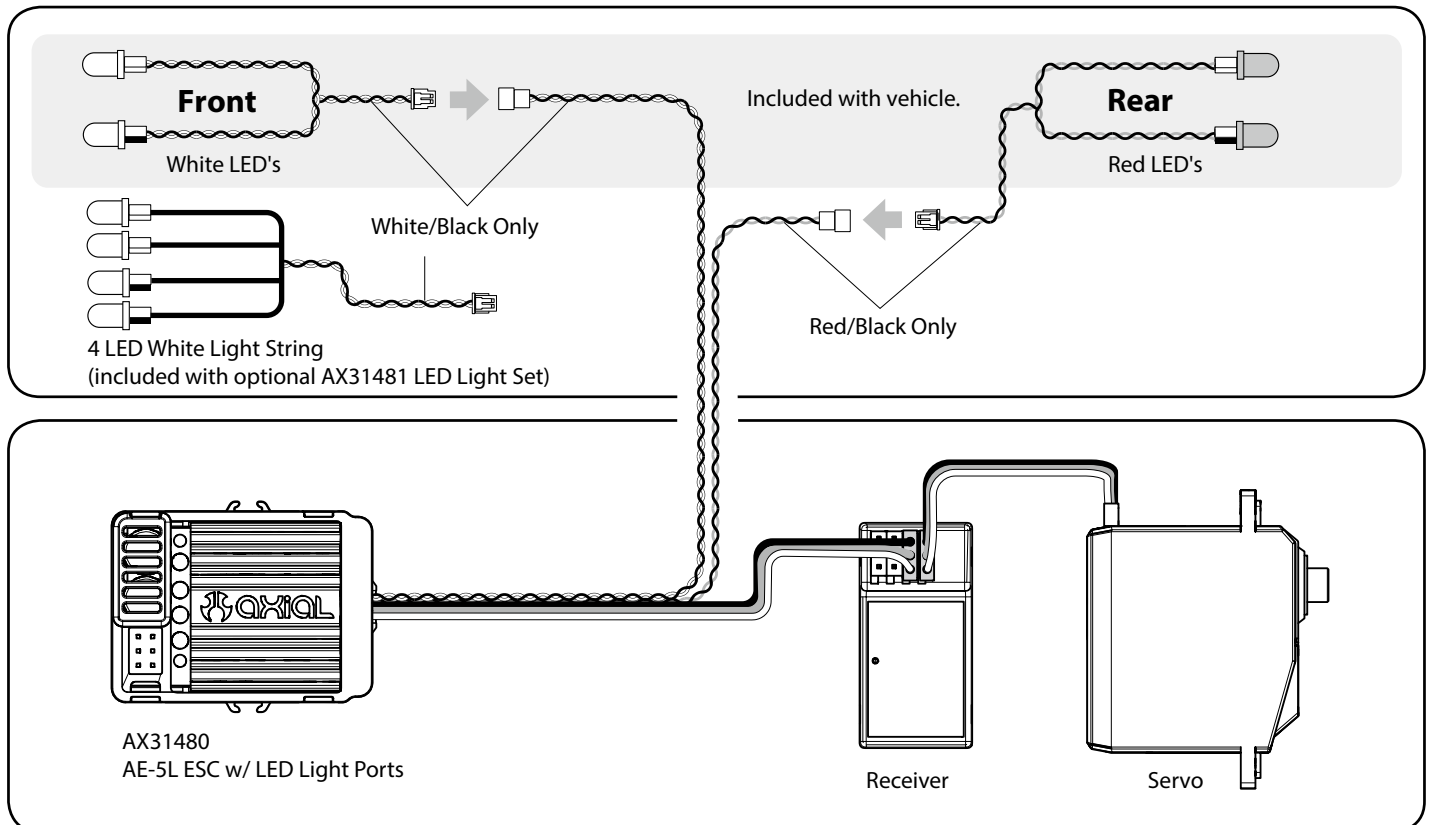

Parts Reference / Übersicht aller Teile / Référence des pièces

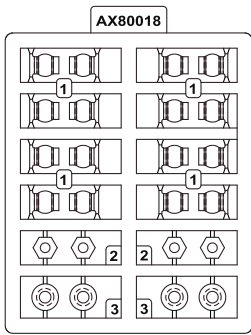

AX80018
Hardware Parts Tree **x2**

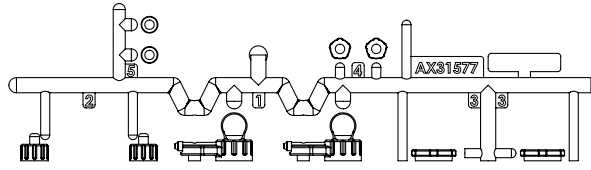

AX31577
Shock Cap Parts Tree **x2**

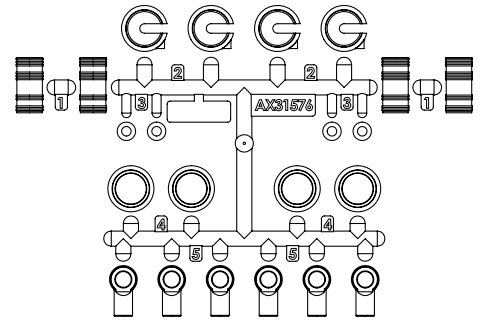

AX31576
10mm Shock Parts Tree **x1**

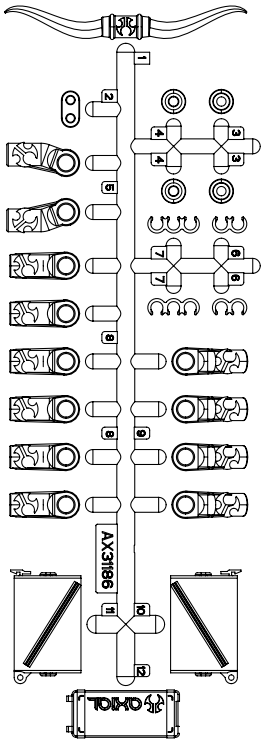

AX31186
M4 Rod End Set **x1**

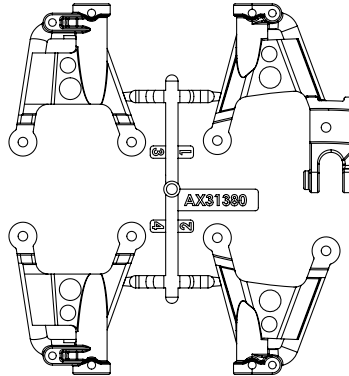

AX31380
SCX10 II Shock Hoops **x1**

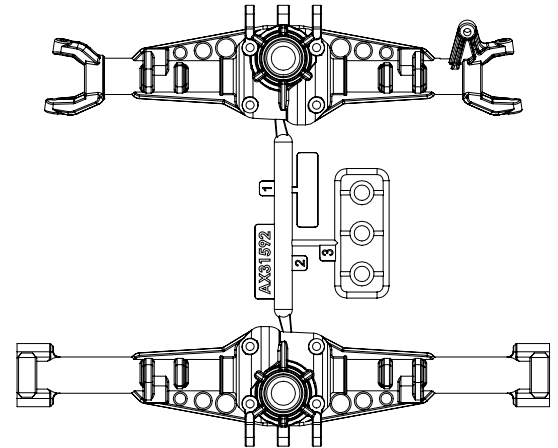

AX31592
AR44 Solid Axle Housing (Front and Rear) **x1**

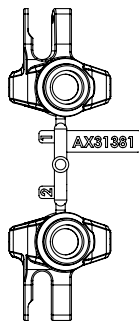

AX31381
AR44 Steering Knuckles **x1**

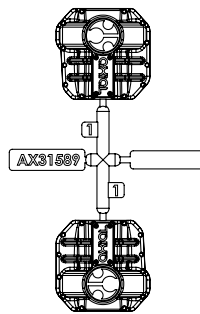

AX31589
AR44 Differential Covers (Red) **x1**

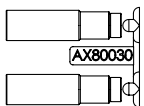

AX80030
61-90mm Shock Body **x2**

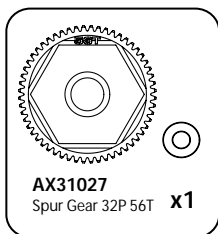

AX31027
Spur Gear 32P 56T **x1**

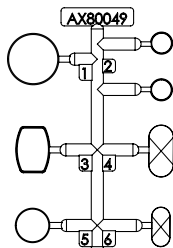

AX80049
LED Lens Set - Clear **x2**

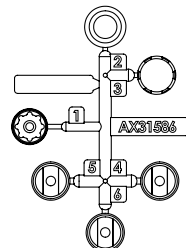

AX31586
WB8-HD Standard Driveshaft **x2**

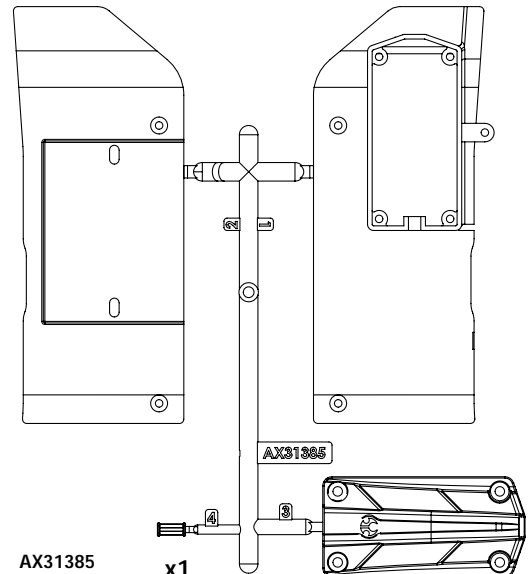

AX31385
SCX10 II Side Plates **x1**

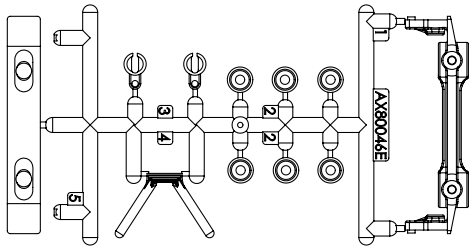

AX80046
1/10th Scale Truggy Bed Set **x1**

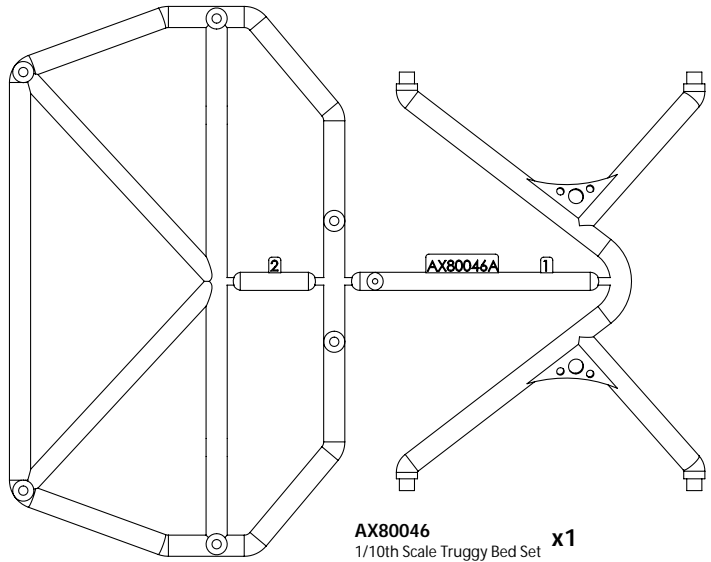

AX80046
1/10th Scale Truggy Bed Set **x1**

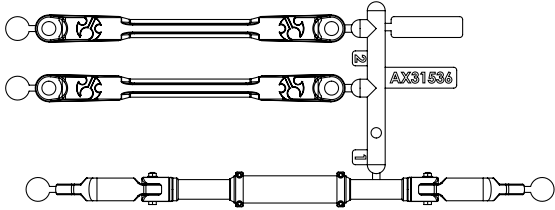

AX31536
SCX10 II Steering Link **x1**

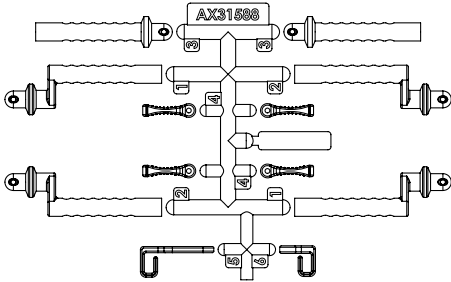

AX31588
Body Mount Set **x1**

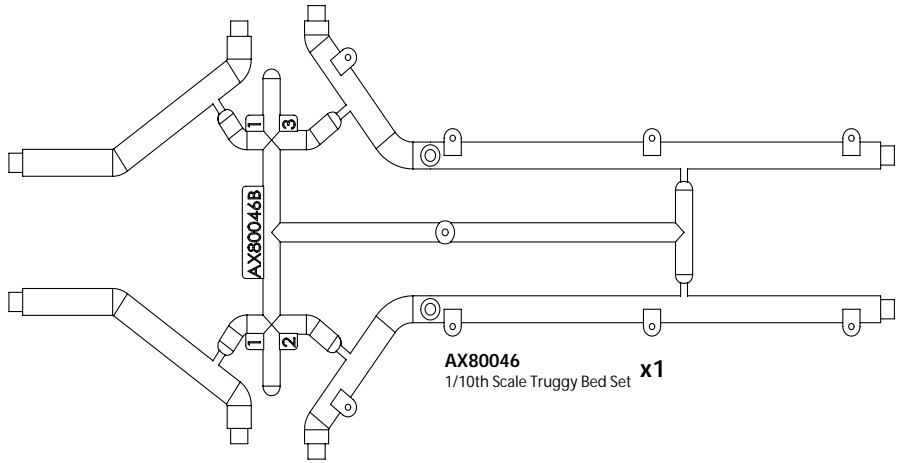

AX80046
1/10th Scale Truggy Bed Set **x1**

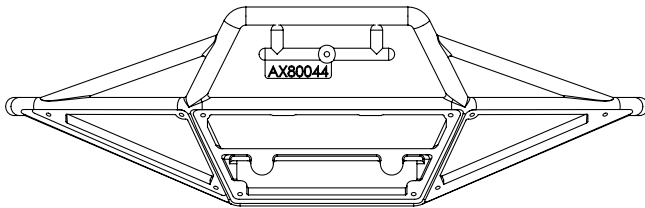

AX80044
Axial SCX10
Tube Bumper Parts Tree **x1**

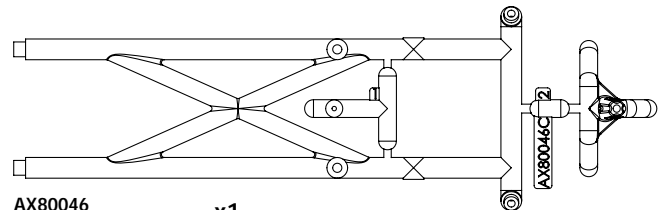

AX80046
1/10th Scale Truggy Bed Set **x1**

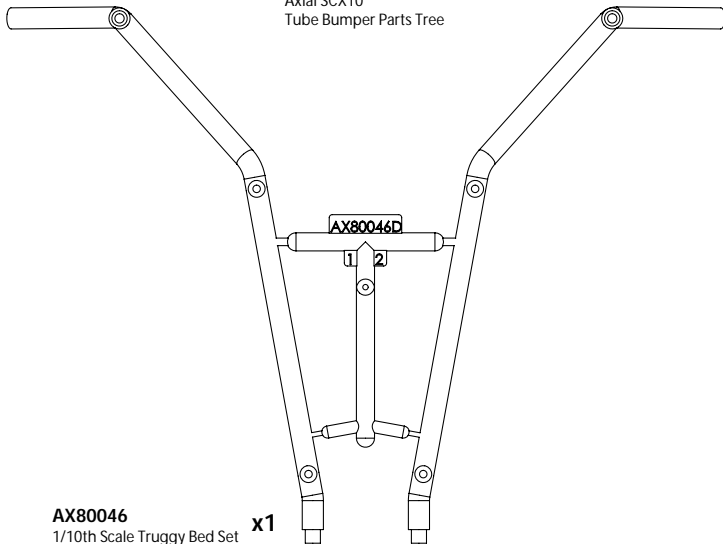

AX80046
1/10th Scale Truggy Bed Set **x1**

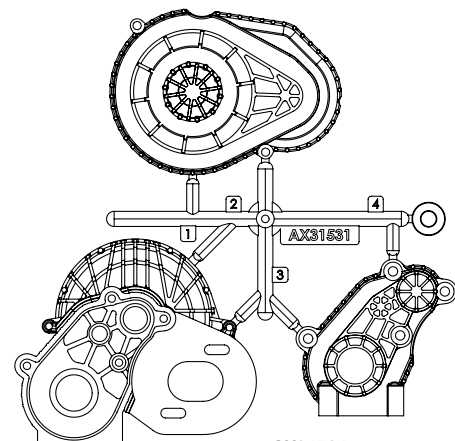

AX31531
LCX Transmission Case (Silver) **x1**

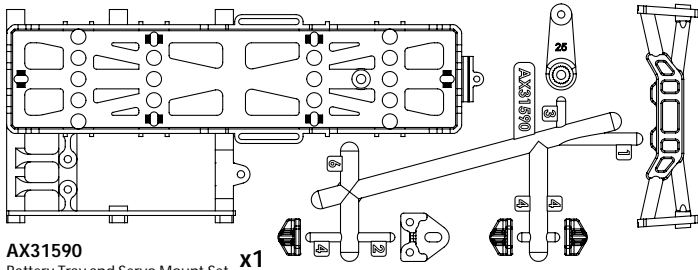

AX31590
Battery Tray and Servo Mount Set **x1**

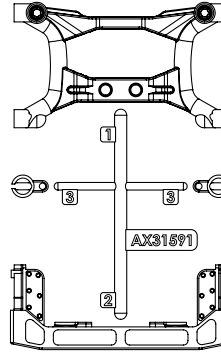

AX31591
Chassis Brace Set **x1**

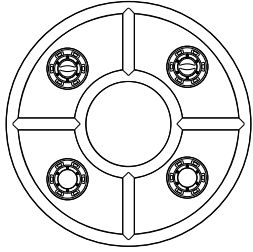

AX8079
Hub Cover Set - Black **x1**

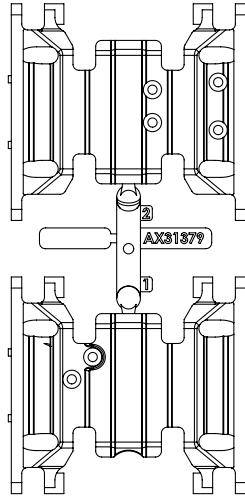

AX31379
SCX10 II Skid Plates **x1**

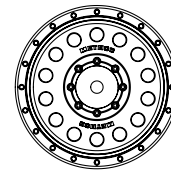

AX31541
1.9 Method MR307 Hole Wheels - Black **x4**

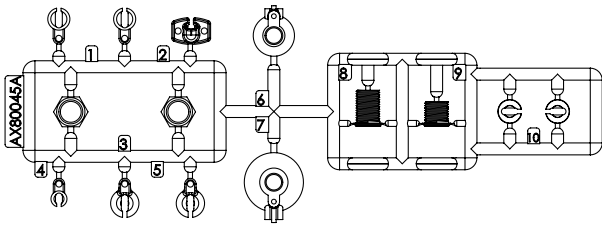

AX80045
Light Bucket Set **x2**

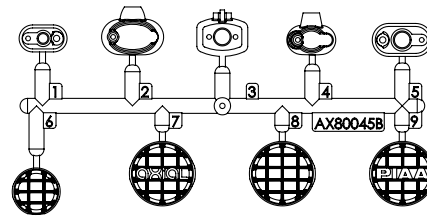

AX80045
Light Bucket Set (Black) **x2**

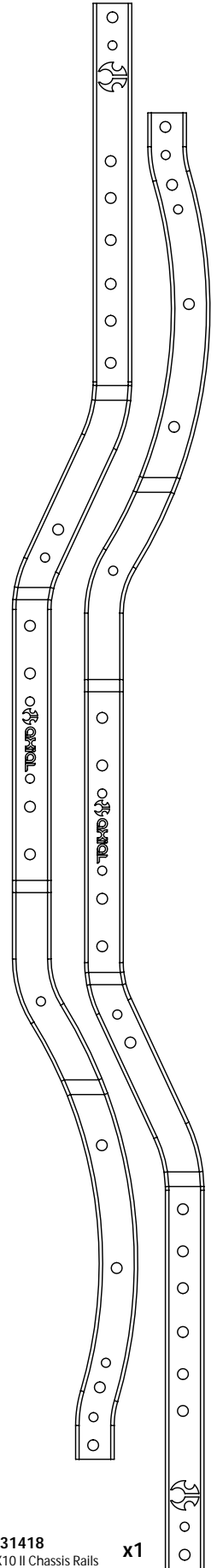

AX31418
SCX10 II Chassis Rails **x1**

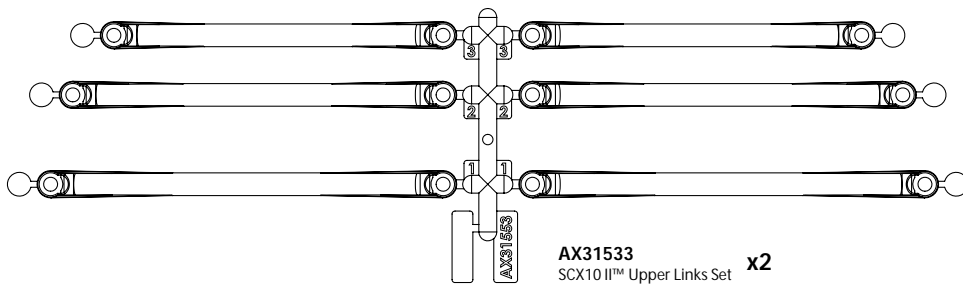

AX31533
SCX10 II™ Upper Links Set **x2**

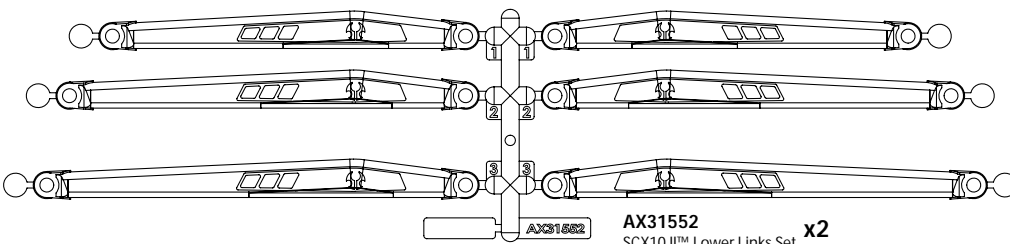

AX31552
SCX10 II™ Lower Links Set **x2**

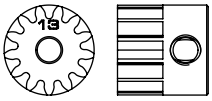

AX30724
Pinion Gear 32P 13T **x1**

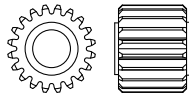

AX30394
20T Drive Gear **x1**

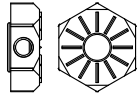

AX30427
Narrow 12mm Aluminum Hub **x4**



AX30413
Slipper spring 8.5x12 **x1**

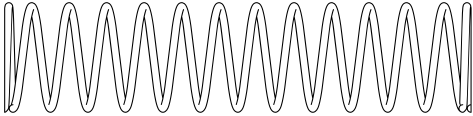

AX31145
Spring 12.5x60mm 2.63 lbs/in - (Yellow) **x2**

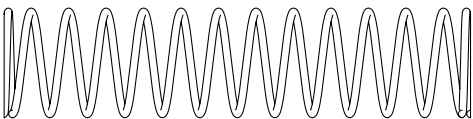

AX31441
Spring 12.5x60mm 1.13 lbs/in - (White) **x2**

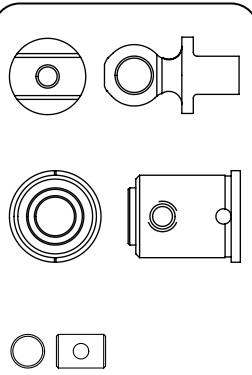

AX31148
WB8-HD Driveshaft Coupler Set **x4**

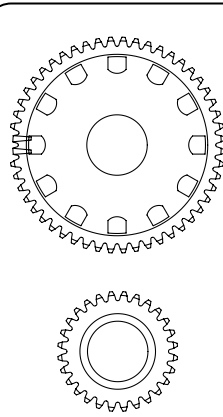

AX80010
Gear Set 52T/28T **x1**

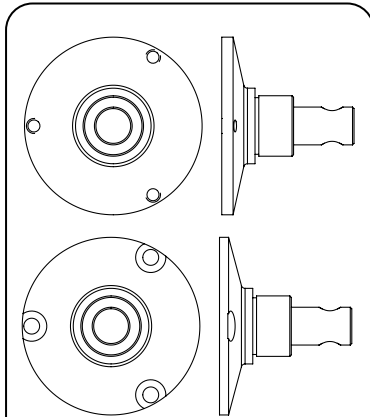

AX30435
Steel Outdrive Shaft **x1**

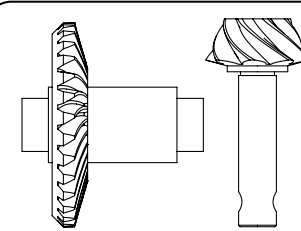

AX31530
AR44 Locker Bevel Gear Set 30T/8T **x2**

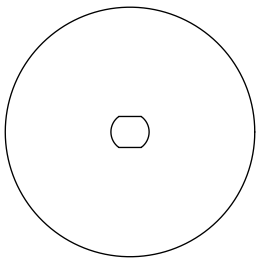

AX31026
Slipper Plate Washer 33x5x1.5mm **x2**

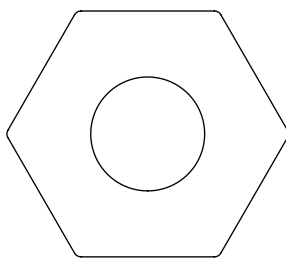

AX31068
Slipper Pad 32.8x15.2x1mm **x2**

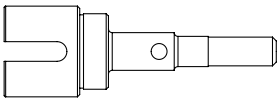

AX31471
Axle 12x36mm **x2**

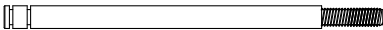

AX30146
Shock Shaft 3x50mm **x4**

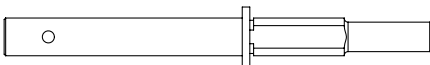

AX31539
Slipper Drive Gear Shaft **x1**

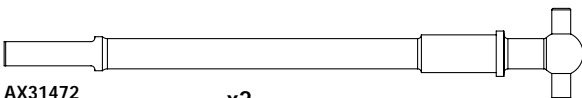

AX31472
Solid Axle Dogbone 6x73.5mm **x2**

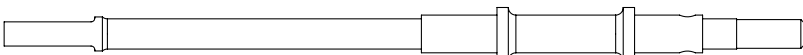



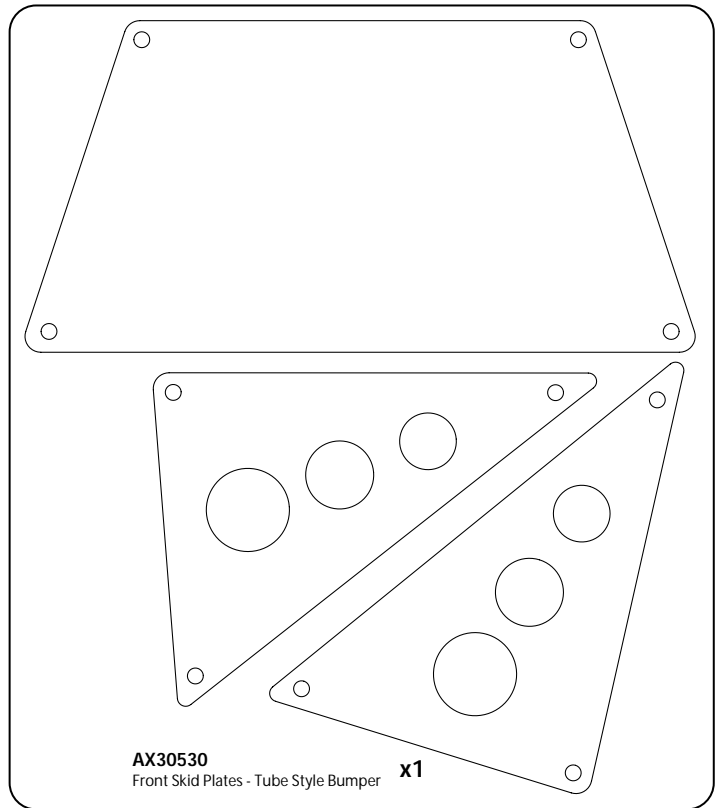



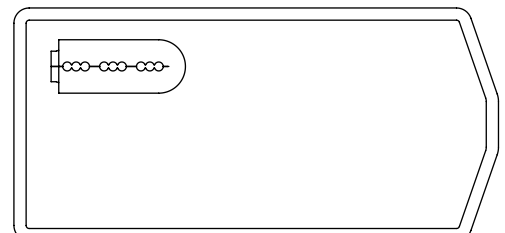



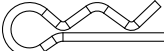



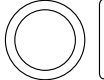











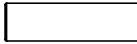













AX31408
AR44 Straight Axle Shaft 5x106mm **x2**

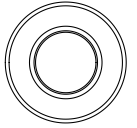

AX30530
Front Skid Plates - Tube Style Bumper **x1**

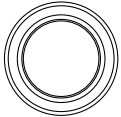

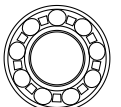
AX31083
Radio Box Seals **x1**

	AXA1179 O-Ring 2.5x1.5mm	x8		AXA1059 6mm Body Clip	x4		AXA1070 Washer 3x6x0.5mm	x1
	AXA1201 O-Ring 3x2mm	x2		AXA0286 Screw Shaft M4x12mm	x8		AXA013 M2x6mm Hex Socket Cap Head	x31
	AXA1163 O-Ring 7x1mm	x4		AXA176 Screw Shaft M3x2.5x13mm	x2		AXA0023 M2.6x8mm Cap Head	x2
	AX30162 Pin 1.5x8mm	x1		AXA176 Screw Shaft M3x2.5x13mm	x2		AX31399 M2.6x18mm Hex Socket Cap Head	x8
	AX30163 Pin 2x10mm	x4		AXA180 M3x3mm Set Screw	x4		AXA0109 M3x10mm Oversized Flat Hex Socket	x6
	AX31028 PIN 2.0 x11	x4		AXA291 M4x4mm Set Screw	x1		AXA144 M3x8mm Hex Socket Flat Head	x5
	AX30190 Shaft 5x18	x1		AX31403 M3x4x10mm Hex Socket Button Head Shoulder Screw	x4		AX31120 M3x10mm Hex Socket Flat Head	x4
	AXA1392 E2 e-clip	x8		AX31373 M2.6x8mm Hex Socket Button Head	x5		AXA146 M3x12mm Hex Socket Flat Head	x12
	AXA1045 M4 Nylon Lock Nut	x5		AXA0113 M3x6mm Hex Socket Button Head	x5		AXA148 M3x18mm Hex Socket Flat Head	x4
	AXA1053 M3 Nylon Lock Nut	x1		AXA114 M3x8mm Hex Socket Button Head	x2		AXA115 M3x10mm Hex Socket Button Head	x10
	AXA1218 Bearing 5x10x4mm	x4		AXA116 M3x12mm Hex Socket Button Head	x1		AXA117 M3x15mm Hex Socket Button Head	x19
	AXA1221 Bearing 5x11x4mm	x8		AXA118 M3x18mm Hex Socket Button Head	x3		AXA1260 M2.5x12mm Hex Socket Tapping Flat Head	x2
	AXA1225 Bearing 8x16x5mm	x2		AXA119 M3x20mm Hex Socket Button Head	x1		AXA468 M3x18mm Hex Socket Tapping Flat Head	x4
	AXA1230 Bearing 10x15x4mm	x2		AXA120 M3x25mm Hex Socket Button Head	x2		AXA469 M3x20mm Hex Socket Tapping Flat Head	x2
	AX31406 Bearing 7x14x3.5mm	x4						
	AX31407 Bearing 5x14x5mm	x2						

Parts List

Part #	Description	Part #	Description
AX30146	Shock Shaft 3x50 (2pcs)	AXA1070	Washer 3x6x0.5mm (10pcs)
AX30162	Pin 1.5x8mm (6pcs.)	AXA114	M3x8mm Hex Socket Button Head (Black) (10pcs)
AX30163	Pin 2.0x10mm (6pcs.)	AXA115	M3x10mm Hex Socket Button Head (Black) (10pcs)
AX30190	Shaft 5x18 (2pcs.)	AXA116	M3x12mm Hex Socket Button Head - Black (10pcs)
AX30394	20T Drive Gear	AXA1163	O-Ring 7x1mm (10pcs)
AX30413	Slipper spring 8.5x12 165 lbs/in - Black (2pcs)	AXA117	M3x15mm Hex Socket Button Head (Black) (10pcs)
AX30427	Narrow 12mm Aluminum Hub - Black (4pcs)	AXA1179	O-Ring 2.5x1.5mm (10pcs)
AX30435	Steel Outdrive Shaft Set (2pcs)	AXA118	M3x18mm Hex Socket Button Head - Black (10pcs)
AX30530	Front Skid Plates - Tube Style Bumper - Silver Aluminum (3pcs)	AXA119	M3x20mm Hex Socket Button Head (Black) (10pcs)
AX30724	Pinion Gear 32P 13T (3mm shaft)	AXA120	M3x25mm Hex Socket Button Head (Black) (10pcs)
AX31026	Slipper Plate Washer 33x5x1.5mm (2pcs)	AXA1218	Bearing 5x10x4mm (2pcs)
AX31027	Spur Gear 32P 56T	AXA1221	Bearing 5x11x4mm (2pcs)
AX31028	Pin 2.0x11mm (6pcs)	AXA1225	Bearing 8x16x5mm (2pcs)
AX31068	Slipper Pad 32.8x15.2x1mm (2pcs)	AXA1230	Bearing 10x15x4mm
AX31083	Radio Box Seals	AXA1260	M2.5x12mm Hex Socket Tapping Flat Head (Black) (10pcs)
AX31120	M3x10mm Hex Socket Flat Head (Black) (10pcs)	AXA1392	E2 e-clip (10pcs)
AX31143	1.9 Falken Wildpeak M/T - R35 Compound (2pcs)	AXA144	M3x8mm Hex Socket Flat Head (Black) (10pcs)
AX31145	Spring 12.5x60mm 2.63 lbs/in - Medium (Grey) (2pcs)	AXA146	M3x12mm Hex Socket Flat Head - Black (10pcs)
AX31148	WB8-HD Driveshaft Coupler Set	AXA148	M3x18mm Hex Socket Flat Head (Black) (10pcs)
AX31186	M4 Rod End Set	AXA176	Screw Shaft M3x2.5x12mm (10pcs)
AX31312	35T Electric Motor	AXA180	M3x3mm Set Screw (Black) (10pcs)
AX31373	M2.6x8mm Hex Socket Button Head (Black) (10pcs)	AXA291	M4x4mm Set Screw (Black) (6pcs.)
AX31379	SCX10 II Skid Plates	AXA434	M3x8mm Hex Socket Tapping Button Head (Black) (10pcs)
AX31380	SCX10 II Shock Hoops	AXA435	M3x10mm Hex Socket Tapping Button Head (Black) (10pcs)
AX31381	AR44 Steering Knuckles	AXA436	M3x12mm Hex Socket Tapping Button Head (Black) (10pcs)
AX31385	SCX10 II Side Plates	AXA468	M3x18mm Hex Socket Tapping Flat Head (Black) (10pcs)
AX31397	WB8-HD Shorty Driveshaft	AXA469	M3x20mm Hex Socket Tapping Flat Head (Black) (10pcs)
AX31398	M2.6x12mm Cap Head (Black) (10pcs)		
AX31403	M3x4x10mm Hex Socket Button Head Shoulder Screw (Black) (6pcs)		
AX31406	Bearing 7x14x3.5mm (2pcs)		
AX31407	Bearing 5x14x5mm (2pcs)		
AX31408	AR44 Straight Axle Shaft 5x106mm (2pcs)		
AX31418	SCX10 II Chassis Rails (2pcs)		
AX31441	Spring 12.5x60mm 1.13 lbs/in - (White) (2pcs)		
AX31471	Axle 12x36mm (2pcs)		
AX31472	Solid Axle Dogbone 6x73.5mm (2pcs)		
AX31480	AE-5L ESC w/LED Ports and Lights (2 White, 4 White, 2 Red)		
AX31481	AE-5L LED Light Set (2 White, 4 White, 2 Red)		
AX31530	AR44 Locker Bevel Gear Set 30T/8T		
AX31531	LCX Transmission Case (Silver)		
AX31536	SCX10 II Steering Link		
AX31539	Slipper Drive Gear Shaft		
AX31540	Flat Bed Insert - .040" (Clear)		
AX31541	1.9 Method MR307 Hole Wheels - Black (2pcs)		
AX31546	Trail Honcho Truck Body - .040" Uncut (Clear)		
AX31552	SCX10 II™ Lower Links Set		
AX31553	SCX10 II™ Upper Links Set		
AX31576	Shock Parts		
AX31577	Shock Caps		
AX31586	WB8-HD Standard Driveshaft		
AX31588	Body Mount Set		
AX31589	AR44 Differential Covers (Red)		
AX31590	Battery Tray and Servo Mount Set		
AX31591	Chassis Brace Set		
AX31592	AR44 Solid Axle Housing (Front and Rear)		
AX80010	Gear Set		
AX80018	Hardware Parts Tree		
AX80030	61-90 Schock Body Set		
AX80044	SCX10 Tube Bumper Parts Tree		
AX80045	Light Bucket Set (Black)		
AX80046	1/10th Scale Truggy Bed Set		
AX80049	LED Lens Set - Yellow/Clear (4pcs)		
AX8079	Hub Cover Set - Black (4pcs)		
AXA0023	M2.6x8mm Cap Head (Black) (10pcs)		
AXA0109	M3x10mm Oversized Flat Hex Socket (Black) (10pcs)		
AXA0113	M3x6mm Hex Socket Button Head (Black) (10pcs)		
AXA013	M2x6 mm Cap Head (Black) (10pcs)		
AXA0286	Screw Shaft M4x2.5x12mm (6pcs)		
AXA1045	M4 Nylon Lock Nut (Black) (10pcs)		
AXA1053	M3 Nylon Locking Hex Nut (Black) (10pcs)		
AXA1059	6mm Body clip (Black) (10pcs)		

Option Parts

Part #	Description	Part #	Description
AX04032	AX10 Ridgecrest Body - .040" (Clear)	AX31394	JCROffroad Vanguard Spare Tire Carrier
AX04033	2012 Jeep Wrangler Unlimited Rubicon™ Body - .040" (Clear) - Body Only	AX31395	JCROffroad Roof Rack
AX04034	2012 Jeep Wrangler Unlimited Rubicon™ Roof - .040" (Clear)	AX31396	Winch Spool and Servo Mounts
AX04035	2012 Jeep Wrangler Unlimited Rubicon™ Body - .040" (Clear) - Complete	AX31412	1.9 BFGoodrich All-Terrain T/A KO2 - R35 Compound (2pcs)
AX04038	Jeep® Wrangler Rock Racer Body - .040" (Clear) - Body Only	AX31437	AR44 Differential Cover and Link Mounts (Black)
AX04039	AX10 Deadbolt Body - .040" (Clear) - Body Only	AX31438	AR44 Locked Axle Set (Front or Rear) (Complete)
AX08138	1.9 Walker Evans Street Wheel - Black (2pcs)	AX31439	SCX10 Transmission Set (Complete)
AX08140	1.9 Walker Evans Street Wheel - Chrome/Black (2pcs)	AX31440	SCX10 Transmission 2-Speed Gear Set
AX12016	1.9 Ripsaw Tires - R35 Compound (2pcs)	AX31441	Spring 12.5x60mm 1.13 lbs/in - (White) (2pcs)
AX12019	1.9 Maxxis Trepador Tires - R35 Compound (2pcs)	AX31442	Spring 12.5x60mm 3.03 lbs/in - (Blue) (2pcs)
AX24003	20T Electric Motor	AX31443	Spring 12.5x60mm 1.70 lbs/in - (Green) (2pcs)
AX24004	Axial 27T Electric Motor	AX31444	Spring 12.5x60mm 0.70 lbs/in - (Red) (2pcs)
AX24007	Axial 55T Electric Motor	AX31465	SCX10 II Front Links Set (Aluminum)
AX24010	Brushless 2900KV Electric Motor	AX31466	SCX10 II Rear Links Set (80mm, 94mm, 101.5mm) (Aluminum)
AX24250	AE-1 Forward/Reverse ESC	AX31467	M4x128mm Steel Links (2pcs)
AX24251	Axial NVS - Night Visions System	AX31468	M4x80mm Steel Links (2pcs)
AX24252	Axial Double LED Light String (White LED)	AX31469	M4x103mm Steel Links (2pcs)
AX24253	Axial Double LED Light String (Red LED)	AX31470	M4x124.5mm Steel Links (2pcs)
AX24254	Axial Double LED Light String (Orange LED)	AX31473	M4x92mm Steel Links (2pcs)
AX24255	Axial Single LED Light String (White LED)	AX31474	M4x114mm Steel Links (2pcs)
AX24256	Axial 5 LED Light String (White LED)	AX4010	Axial Dingo Truck Body - .040" uncut (Clear)
AX24257	Simple LED Controller w/LED lights (4 white and 2 Red)	AX4010R	Axial Dingo Truck Body - .040" uncut (Clear) - Body Only
AX24258	4 LED Light String (White LED)	AX4025	Axial Trail Honcho Truck Body - .040" uncut (Clear) w/Molded Rear Cage
AX24259	Axial AE-2 Forward/Reverse ESC w/Drag Brake	AX4025R	Axial Trail Honcho Truck Body - .040" uncut (Clear) - Body Only
AX24260	AE-3 Vanguard ESC	AX80037	Interior Details Parts Tree - Black
AX30090	Axial 61-90mm Aluminum Shock Set - 7mm Piston (2pcs)	AX80038	Exterior Detail Parts Tree - Black
AX30103	Icon 61-90mm Aluminum Shock Set - 7mm piston (2pcs)	AX80039A	1/10th Scale Front Plate Bumper Set
AX30114	Axial Hard Anodized Aluminum Shock Reservoir (2pcs)	AX80039B	1/10th Scale Rear Plate Bumper Set
AX30115	Axial Hard Anodized Aluminum Pre-load collar (2pcs)	AX80040	1/10th Scale Fender Flare Set (2pcs)
AX30117	Axial Hard Anodized Aluminum Shock Body 10x38mm (2pcs)	AX80041	1/10th Scale Rock Rails Set (2pcs)
AX30130	Icon Clear Anodized Aluminum Shock Body 10x38mm (2pcs)	AX80044	SCX10 Tube Bumper Parts Tree
AX30131	Icon Clear Anodized Aluminum Shock Reservoir (2pcs)	AX80045	Light Bucket Set (Black)
AX30132	Machined Shock Piston 7mm - 1.5x3 (4pcs)	AX80047	Interior Details Parts Tree - Chrome
AX30200	Spring 12.5x20mm 3.6 lbs/in - Super Soft (Red) - (2pcs)	AX80048	Exterior Detail Parts Tree - Chrome
AX30201	Spring 12.5x20mm 4.32 lbs/in - Soft (White) - (2pcs)	AX80049	LED Lens Set - Yellow/Clear (4pcs)
AX30202	Spring 12.5x20mm 5.44 lbs/in - Medium (Green) - (2pcs)	AX80085	Universal Mount 5 Bucket Light Bar (Black)
AX30203	Spring 12.5x20mm 6.53 lbs/in - Firm (Yellow) - (2pcs)	AX80086	Light Bar Lenses (Clear) (5pcs)
AX30204	Spring 12.5x20mm 7.95 lbs/in - Super Firm (Blue) - (2pcs)	AX80115	Light Bar Lens Grills (Axial, PIAA, Un-Marked)
AX30205	Spring 12.5x40mm 2.7 lbs/in - Super Soft (Red) - (2pcs)	AX80126	SCX10 Poison Spyder JK RockBrawler Rear Bumper and Tire Carrier
AX30206	Spring 12.5x40mm 3.6 lbs/in - Soft (White) - (2pcs)	AX80128	Wheel Hub Adapters (2pcs Narrow, 2pcs Wide)
AX30207	Spring 12.5x40mm 4.08 lbs/in - Medium (Green) - (2pcs)	AX8080	Hub Cover Set - Satin Chrome (4pcs)
AX30208	Spring 12.5x40mm 5.44 lbs/in - Firm (Yellow) - (2pcs)	AX8087	1.9 8 Hole Beadlocks - Black (2pcs)
AX30209	Spring 12.5x40mm 6.81 lbs/in - Super Firm (Blue) - (2pcs)	AX8088	1.9 8 Hole Beadlocks - Satin Chrome (2pcs)
AX30547	1.9 Internal Wheel Weight Ring 43g/1.5oz (2pcs)	AX8122	1.9 Beadlock Ring - Grey (2pcs)
AX30548	1.9 Internal Wheel Weight Insert 9g/0.33oz (4pcs) (for use with AX30547)	AX8127	1.9 Rock Beadlock Ring - Grey (2pcs)
AX30709	Universal 5 Bucket Light Bar Set	AXA1046	M4 Serrated Nylon Lock Nut (Blue) (4pcs)
AX30834	Aluminum Servo Horn 23T	AXA1076	Cap Head Washer M3x10mm (4pcs)
AX30835	Aluminum Servo Horn 24T	AXA1101	Cone Washer 3x6.9x2mm (6pcs)
AX30836	Aluminum Servo Horn 25T	AXA1104	Cone Washer 3x6.9x2mm - Orange (6pcs)
AX31047	Brushless 3150KV Electric Motor	AXA1105	Cone Washer 3x6.9x2mm - Grey (6pcs)
AX31093	1.9 BFGoodrich Krawler T/A - R35 Compound (2pcs)	AXA1331	Flanged Ball 3x5.8x7mm (6pcs)
AX31094	1.9 Black Rock CRC Wheels - Black (2pcs)	AXA1412	0.5x6mm Spacer - Grey (6pcs)
AX31097	3 Port High Output LED Controller	AXA1413	1x6mm Spacer - Grey (6pcs)
AX31098	8 LED Light String (White LED)	AXA1414	2x6mm Spacer - Grey (6pcs)
AX31143	1.9 Falken Wildpeak M/T - R35 Compound (2pcs)	AXA1415	3x6mm Spacer - Grey (6pcs)
AX31144	AE-5 Waterproof Forward/Reverse ESC w/Drag Brake	AXA1416	4x6mm Spacer - Grey (6pcs)
AX31152	Universal Rigid Light Bar Set	AXA1417	5x6mm Spacer - Grey (6pcs)
AX31176	Spawn Body - .040" (Clear)	AXA1418	6x6mm Spacer - Grey (6pcs)
AX31250	M4 Serrated Nylon Lock Nut (Black) (10pcs)	AXA1419	7x10mm Post - Grey (2pcs)
AX31267	Jeep® NuKizer 715 Body - .040" (Clear)	AXA1420	7x15mm Post - Grey (2pcs)
AX31268	Jeep® Mighty FC Body - .040" (Clear)	AXA1421	7x20mm Post - Grey (2pcs)
AX31312	35T Electric Motor	AXA1422	7x25mm Post - Grey (2pcs)
AX31314	Aluminum Shock Body 12x47.5mm (Clear Anodized) (2pcs)	AXA1423	7x30mm Post - Grey (2pcs)
AX31325	2.2 BFGoodrich Baja T/A KR2 Tires - R35 Compound (2pcs)	AXA1424	7x35mm Post - Grey (2pcs)
AX31326	2.2 Walker Evans Wheels - Black (2pcs)	AXA1425	7x40mm Post - Grey (2pcs)
AX31329	35T Trail Breaker Electric Motor (Rebuildable)	AXA1426	7x45mm Post - Grey (2pcs)
AX31330	55T Trail Breaker Electric Motor (Rebuildable)	AXA1427	7x50mm Post - Grey (2pcs)
AX31337	2000 Jeep® Cherokee Body - .040" (Clear) - Body Only	AXA1428	7x55mm Post - Grey (2pcs)
AX31338	Trail Breaker Electric Motor Rebuild Kit	AXA1429	7x60mm Post - Grey (2pcs)
AX31392	JCROffroad Vanguard Front Bumper	AXA1430	7x65mm Post - Grey (2pcs)
AX31393	JCROffroad Vanguard Rear Bumper	AXA1431	7x70mm Post - Grey (2pcs)



EXPLORE

facebook.com/axialinc | twitter.com/axialrc | youtube.com/axialvideos | flickr.com/axialrc