

MODEL 64077-3

XO-1

TRAXXAS
OWNER'S MANUAL

TABLE OF CONTENTS

- 3 SAFETY PRECAUTIONS
- 6 BEFORE YOU PROCEED
- 7 TOOLS, SUPPLIES, AND REQUIRED EQUIPMENT
- 8 ANATOMY OF THE XO-1
- 9 QUICK START: GETTING UP TO SPEED
- 10 TRAXXAS TQi RADIO SYSTEM
- 18 ADJUSTING THE ELECTRONIC SPEED CONTROL
- 19 DRIVING YOUR MODEL
- 20 BASIC TUNING ADJUSTMENTS
- 23 MAINTAINING YOUR MODEL
- 25 ADVANCED TUNING ADJUSTMENTS
- 28 DRIVING 100MPH
- 31 TQi ADVANCED TUNING GUIDE

Thank you for purchasing the XO-1™. This model is capable of extreme performance and high speeds unsurpassed by any other R/C vehicle, with the durability and ease of use that are hallmarks of Traxxas' Ready-To-Race® models. The included TQi 2.4GHz transmitter with the Traxxas Link™ Wireless Module is ready to accept your Apple® iPhone®, iPad®, iPod touch®, or Android™ device and the Traxxas Link application for a new level of tuning sophistication and convenience.

This manual contains the instructions you will need to operate and maintain your model so that you can enjoy it for years to come. We know you're excited about getting your new model on the road, but it's very important that you take some time to read through the Owner's Manual. This manual contains all the necessary setup and operating procedures that will allow you to unlock the performance potential that Traxxas engineers designed into your model.

Be sure to read and follow ALL precautions and warnings in this manual, on all documents enclosed with your model, and on all labels or tags attached to your model or model's accessories. They are there to educate you on how to operate your model safely and how to get maximum life and performance from your model.

Even if you are an experienced R/C enthusiast, it's important to read and follow the procedures in this manual and all accompanying documents. Thank you again for going with Traxxas. We work hard every day to assure you receive the highest level of customer satisfaction possible. We truly want you to enjoy your new model!

FCC Compliance

This device contains a module that complies with the limits for a Class B digital device as described in part 15 of the FCC rules. Operation is subject to the following two conditions: (1) This device may not cause harmful interference, and (2) this device must accept any interference received, including interference that may cause undesired operation.

The limits for a Class B digital device are designed to provide reasonable protection against harmful interference in residential settings. This product generates, uses and can radiate radio frequency energy, and, if not operated in accordance with the instructions, may cause harmful interference to radio communications. The user is cautioned that changes or modifications not expressly approved by the party responsible for compliance could void the user's authority to operate the equipment.

Canada, Industry Canada (IC)

This Class B digital apparatus complies with Canadian ICES-003 and RSS-210. This device complies with Industry Canada license exempt RSS standard(s). Operation is subject to the following two conditions: This device may not cause interference, and this device must accept any interference, including interference that may cause undesired operation of the device.

Radio Frequency (RF) Exposure Statement

This equipment complies with radio frequency exposure limits set forth by FCC and Industry Canada for an uncontrolled environment. This equipment should be installed and operated with a minimum distance of 20 centimeters between the radiator and your body or bystanders and must not be co-located or operating in conjunction with any other antenna or transmitter.

TQi Radio System

Operation Frequency: 2414~2453 MHz

Maximum Radio Frequency Power: Maximum Peak Power 9.7 dBm

Traxxas High-Current Connector

Operation Frequency: 13.56 MHz

Maximum Radio Frequency Power: Maximum Peak Power -29.27 dBuA/m @ 10m

Traxxas Support

Traxxas support is with you every step of the way. Refer to the next page to find out how to contact us and what your support options are.



Quick Start

This manual is designed with a Quick Start path that provides an overview of the necessary procedures to get your model up and running. The Quick Start is NOT a substitute for reading the entire manual. The Quick Start is merely intended to direct you to sections of the manual to more quickly familiarize yourself with the basics of this model's operation. Do not run the model without thoroughly reading all of the instructions, warnings, and precautions supplied with your model. Pay particular attention to the warnings in the beginning and throughout the remainder of this manual. The Quick Start guide is located on page 9.



REGISTERING YOUR MODEL

In order to serve you better as our customer, please register your product within 10 days of your purchase online at Traxxas.com/register.

Traxxas.com/register

Entire contents ©2020 Traxxas. Traxxas, Ready-To-Race, Ready-To-Win, XO-1 and ProGraphix are trademarks or registered trademarks of Traxxas. Other brand names and marks are the property of their respective holders and are used only for purposes of identification. No part of this manual may be reproduced or distributed in print or electronic media without the express written permission of Traxxas. Specifications are subject to change without notice.

Traxxas
6250 Traxxas Way
McKinney, Texas 75070
Phone: 972-549-3000
Toll-free: 1-888-TRAXXAS

Internet:
Traxxas.com
E-mail:
support@Traxxas.com



WARNING!

RISK OF FIRE, INJURY, OR DEATH



Experts Only! This product is not a toy. This product carries our highest skill level rating, 10, and is not intended for use by children or minors under the age of 16. Individuals under the age of 18 require responsible adult supervision during operation and maintenance. The XO-1 is only intended to be owned and operated by experienced users, with advanced skills, and expert driving ability. Responsibility, maturity, and common sense are required. This model must be treated with absolute respect and caution to ensure the safety of yourself and others around you. It must only be driven at its top speed on a closed course such as a racetrack or drag strip where there are safety barricades and pedestrian access controls. Operating the XO-1 in a careless, unsafe manner, without adequate care and preparation, can result in collisions with catastrophic consequences such as serious injury or death. Know your limits. Be honest with yourself about your true ability and be certain you have a location where you can safely run the model.

The XO-1 is designed for use with LiPo batteries. LiPo batteries have a severe risk of fire and injury if they are improperly handled, abused, or misused. User must read and understand all included instructions, warnings, and precautions regarding the handling, care, and use of LiPo batteries. A LiPo balance charger (such as the Traxxas EZ-Peak Plus (part #2970) or the Traxxas EZ-Peak Dual (part #2972), each sold separately) is required to charge the batteries. Consult Traxxas or your hobby dealer if you do not know what a LiPo balance charger is. **NEVER USE A NIMH OR NICAD CHARGER TO CHARGE LIPO BATTERIES AS THIS CAN CAUSE FIRE RESULTING IN PROPERTY DAMAGE, AND/OR PERSONAL INJURY OR DEATH.**

Liability Statement:

This product is surrendered by Traxxas to the purchaser with the understanding that the purchaser accepts the responsibility that driving this model and using the enclosed accessories in a careless, improper, or unsafe manner can result in serious injury or death. Also, the purchaser assumes all liability resulting from any misuse, unsafe handling, failure to follow instructions, or any action that constitutes a violation of any applicable laws or regulations. Traxxas, and all Traxxas suppliers and component makers, shall not be liable for personal injury, loss of property, or loss of life resulting from the use of this product under any circumstances, including intentional, reckless, negligent, or accidental behavior. Traxxas, and all Traxxas suppliers and component makers, shall also not be liable for any special, indirect, incidental, or consequential damages arising out of the assembly, installation, or use of their products or any accessory or chemical required to use their products. By the act of operating/using the product, the user accepts all resulting liability and releases Traxxas, and all Traxxas suppliers and component makers, of any and all liability associated with its use.

If you as the user do not accept liability of ownership, Traxxas requests that you do not use this product. Do not open any of the enclosed materials. Return the model to your hobby dealer. **Your hobby dealer absolutely cannot accept an item for return or exchange after it has been run or is otherwise no longer in as-new condition.**

All information contained in this manual is subject to change without notice. Traxxas reserves the right to make changes and improvements to products without incurring any obligation to incorporate such improvements into products previously sold.

Safety Is Your Responsibility!



All instructions and precautions outlined in this manual should be strictly followed to ensure safe operation of your model.



All of us at Traxxas want you to safely enjoy your new model. The precautions outlined in this manual should be strictly followed to help ensure safe operation. You alone must see that the instructions are followed and the precautions are adhered to.



The XO-1 is optimized for use with LiPo batteries. LiPo batteries have a severe risk of fire and injury if they are improperly handled, abused, or misused. User must read and understand all included instructions, warnings, and precautions regarding the handling, care, and use of LiPo batteries. A LiPo balance charger (such as the Traxxas EZ-Peak® Dual, part #2972, or the Traxxas EZ-Peak® Live Dual, part #2973, each sold separately) is required to charge LiPo batteries. DO NOT charge LiPo batteries with a NiMH Charger. Read the additional warnings for LiPo batteries on Page 5 of this manual.

- Because your model is controlled by radio, it is subject to radio interference from many sources that are beyond your control. Since radio interference can cause momentary losses of radio control, always allow a safety margin in all directions around the model in order to prevent collisions.
- Range test your radio system in the area that you will be running the model to ensure that you have range that covers the area you want to drive. After range testing, drive slowly in the area at first to make sure there is no interference that can cause momentary lapses of control.



Always use new batteries in your model to maximize signal power output and range.

- The motors, batteries, and speed control can become hot during use. Be careful to avoid getting burned.
- Choose the right location to drive. Your model is absolutely not intended for use on public roads or congested areas where its operation can conflict with or disrupt pedestrian or vehicular traffic.



Only drive the XO-1 on a closed course with safety barricades and pedestrian access controls. This is to prevent the possibility of injury or death resulting from collision with the model by another human being or animal.

- Do not drive the XO-1 by yourself. Bring a friend along to act as a spotter to alert you if a person or animal is approaching your driving course.
- Do not operate your model at night, or anytime your line of sight to the model may be obstructed or impaired in any way.
- Do not drive the model close to you where a mistake or loss of control could cause the model to collide with you or any spectator.
- Inspect the area you will be driving in for uneven or broken pavement and debris of any sort. Debris and poor road surfaces could cause damage and/or loss of control of the model.
- Always carefully inspect your model for damage or loose components before running. Do not drive the model if it is damaged in any way. Tighten any loose hardware. Tighten the wheel nuts before each running session and periodically check the tightness of the wheel nuts while you are running.
- Never pick up the model by its tires or wheels. Always keep your hands safely clear of moving parts whenever the batteries are plugged in.
- Keep the XO-1 stored with the batteries removed, out of the reach of children and protected from access by any other unauthorized driver. Lock the power system whenever the model is stored to prevent access to its full 100mph capability by unauthorized drivers.
- Always disconnect the batteries in the model when it is not in use. Never store the vehicle with batteries in the model, as this can cause a fire leading to property damage, serious personal injury, or even death.
- Most importantly, use good common sense at all times.

This list of warnings and precautions is not comprehensive. Be sure to read this entire manual and note other more detailed warnings and precautions contained within.



WARNING! CAUTION! DANGER!

FIRE HAZARD! Before use, read and follow all manufacturer's charging and handling instructions, warnings and precautions! Lithium Polymer batteries pose a severe risk of fire if not properly handled and charged per the manufacturer's instructions. Never allow children under the age of 14 to charge batteries without the supervision of a responsible, knowledgeable adult.

- While charging, always place the battery in a fire retardant/fire proof container and on a non-flammable surface such as concrete.
- ALWAYS charge batteries in a well-ventilated area.
- REMOVE flammable items and combustible materials from the charging area.
- ONLY use a Lithium Polymer (LiPo) balance charger with a balance adapter to charge LiPo batteries.
- NEVER leave batteries unattended while charging.
- If any battery or cell is damaged in any way, do NOT charge, discharge, or use the battery.
- BEFORE you charge, ALWAYS confirm that the charger settings exactly match the battery type (chemistry), specification and configuration to be charged.
- DO NOT exceed the maximum recommended charge rate.
- DO NOT disassemble, crush, short circuit or expose to flame or other source of ignition.



WARNING - Lithium Polymer (LiPo) batteries are significantly more volatile than other rechargeable batteries. Charging and discharging batteries has the potential for fire, explosion, serious injury, and property damage if not performed per the instructions.

ONLY use a LiPo Balance charger specifically designed for LiPo batteries. Traxxas recommends our EZ-Peak Plus Charger (part #2970) or EZ-Peak Dual Charger (part #2972), each sold separately. Never use NiMH- or NiCad-type chargers or charge modes to charge LiPo batteries. The use of a NiMH or NiCad charger or charge mode will damage the batteries and may cause fire and personal injury.

NEVER charge or use a LiPo battery or pack that shows any kind of damage or deformity. Swelling is a sign of internal damage. If a battery becomes swollen, deformed or appears damaged, DO NOT CHARGE. Follow the disposal instructions below to properly and safely dispose the battery.

NEVER allow children under the age of 14 to charge batteries without the supervision of a responsible, knowledgeable adult.

ALWAYS inspect your LiPo batteries carefully before charging. Look for any loose leads or connectors, damaged wire insulation, damaged cell packaging, impact damage, fluid leaks, swelling (a sign of internal damage), cell deformity, missing labels, or any other damage or irregularity. If any of the above conditions are observed, DO NOT CHARGE or use the battery pack. Follow the "BATTERY DISPOSAL INSTRUCTIONS" included and safely dispose of the battery.

DO NOT let any exposed battery contacts or wires touch each other. This will cause the battery to short circuit and create the risk of fire.

ALWAYS charge batteries in a flame retardant/fire proof container.

NEVER charge batteries, in your model, on wood, cloth, carpet or on any other flammable surfaces. Keep a chemical fire extinguisher in nearby in case of fire.

DO NOT store or charge LiPo batteries with or around other batteries or battery packs of any type, including other LiPos. Store and transport your LiPo batteries in a cool dry place. DO NOT store in direct sunlight. DO NOT allow the storage temperature to exceed 140°F/60°C or the cells may be damaged and risk of fire created.

DO NOT disassemble LiPo cells and charge.

DO NOT attempt to build your own LiPo battery Pack from loose cells.

STORE battery packs safely out of the reach of children and pets.

ALWAYS proceed with caution and use good common sense at all times.

BATTERY CHARGING AND DISCHARGING PRECAUTIONS

Charging and discharging LiPo batteries, unlike other batteries, has a greater risk of fire resulting in personal injury and property loss.

Traxxas Power Cell LiPo iD batteries feature innovative balance leads that are integrated into the connector and isolate each cell in a pack and charge each cell independently. This ensures that all cells balance equally and discharge at the same rate during use. **Always use a balance charger with all Traxxas Power Cell LiPo iD battery packs. Traxxas recommends the EZ-Peak Plus Charger (part #2970) or the EZ-Peak Dual Charger (part #2972), each sold separately.**

Always make sure that your charger settings match those listed on the battery pack label. Improper battery information inputting will result in battery damage and create a serious risk of fire.

DO NOT leave the charger and battery unattended while charging, discharging, or anytime the charger is ON. If there are any signs of a malfunction, unplug the power source to stop the charging process immediately.

If at any time during the charging or discharging process the battery begins to balloon or swell, discontinue charging (or discharging) immediately. Quickly and safely disconnect the battery, then place it in a safe, open area away from flammable materials to observe it for at least 30 minutes. Continuing to charge or discharge a battery that has begun to balloon or swell can result in a fire. A battery that has ballooned or swollen even a small amount must be removed from service permanently.

Make sure charger settings match the battery type and specifications. Refer to the battery label for the proper cell count and charging amperage setting.

- Battery Chemistry
- Maximum Charge Rate
- Cell Configuration
- Voltage

Make sure the battery connections are connected in the correct polarity. Black is negative (-) and red is positive (+). A wrong connection will damage the battery and create a serious risk of fire.

Any time a battery gets hot to the touch during the charging process (temperature greater than 110°F / 43°C), discontinue charging immediately and disconnect the battery from the charger.

Never charge LiPo battery packs in series or parallel. Charge each battery pack individually only. Charging packs in series or parallel may result in improper charger cell recognition, and an improper charging rate that may lead to overcharging, cell imbalance, cell damage, and fire. We recommend using the Traxxas EZ-Peak Plus or EZ-Peak Dual when charging your LiPo batteries. The Traxxas EZ-Peak Plus and EZ-Peak Dual are specifically designed to automatically peak charge individual pack cells (up to 6 cell packs) with convenience and ease.

DO NOT attempt to charge a battery with low voltage below 2.8V per cell.

DO NOT exceed the maximum recommended charging rate.

Never charge a LiPo battery to more than 4.2 Volts per cell. Any cell that is charged to a voltage higher than 4.2V can be damaged and potentially catch fire. **Never "trickle" charge a LiPo battery. Trickle charging at even the lowest possible rate will cause the cells within the battery to charge beyond 4.2V, resulting in cell damage and potential fire.**

DO NOT charge a 2S (7.4V nominal) battery to more than 8.4V.
DO NOT charge a 3S (11.1V nominal) battery to more than 12.6V.

The Battery's temperature is important. Use the following temperature ranges as guidelines:

- Charge Temp Range: 32 - 110°F / 0-43°C
- Discharge Temp Range: 32 - 140°F / 0-60°C

For optimum performance in cold climates, warm the pack to 100°F/37°C before use. After use or discharging, the battery must cool to ambient temperature before charging.

BATTERY DISPOSAL INSTRUCTIONS

1. Discharge battery pack to 2.8 Volts per cell or less.
2. Fill a bucket with enough water to submerge the battery pack completely.
3. Add salt to the water until no more salt will dissolve; the water is now saturated with salt.
4. Place the battery pack in the bucket and leave submerged in the salt-water solution for 24 hours.
5. Remove the battery pack from the salt water and test the voltage with a voltmeter.
6. If the voltage does not read 0.0 Volts, re-submerge and re-test until the voltage reads 0.0 Volts.
7. Once the battery pack has been discharged to 0.0 Volts, it is safe to dispose.
8. Recycle by calling RBRC at 1-800-8-BATTERY (1-800-8-228-8379) for the nearest recycling drop off location.

The XO-1 features a Castle Creations Brushless System pre-installed from the factory. The XO-1 is manufactured by Traxxas and is backed by full Traxxas factory support. The installed Mamba Monster Extreme power system (electronic speed control, motor, on/off switch) is manufactured by Castle Creations. Traxxas will direct warranty claims and related support for the power system directly to Castle Creations and those claims will be subject to Castle Creations' warranty and service terms. Traxxas does not provide direct service and support for the installed power system. If you cannot accept this product support arrangement, do not run the model or open any of the enclosed materials. Return the model to your hobby dealer. **Note that your hobby dealer absolutely cannot accept an item for return or exchange after it has been run or is otherwise no longer in as-new condition.**



Note: The Power System is **NOT WATERPROOF**.

Do not expose the power system to any type of water, condensation, or moisture. Water damage voids warranty coverage.

Warnings, Helpful Hints, & Cross-References

Throughout this manual, you'll notice warnings and helpful hints identified by the icons below. Be sure to read them!



An important warning about personal safety or avoiding damage to your model and related components.



Special advice from Traxxas to make things easier and more fun.



Refers you to a page with a related topic.

Support

If you have any questions about your model or its operation, call the Traxxas Technical Support line toll-free at: **1-888-TRAXXAS (1-888-872-9927)***

Technical support is available Monday through Friday from 8:30am to 9:00pm central time. Technical assistance is also available at Traxxas.com. You may also e-mail customer support with your question at support@Traxxas.com. Join thousands of registered members in our online community at Traxxas.com.

Traxxas offers a full-service, on-site repair facility to handle any of your Traxxas service needs. Maintenance and replacement parts may be purchased directly from Traxxas by phone or online at BuyTraxxas.com. You can save time, along with shipping and handling costs, by purchasing replacement parts from your local dealer.

Do not hesitate to contact us with any of your product support needs. We want you to be thoroughly satisfied with your new model!

TOOLS, SUPPLIES, AND REQUIRED EQUIPMENT

Your model comes with a set of specialty metric tools. You'll need to purchase other items, available from your hobby dealer, to operate and maintain your model.

SUPPLIED TOOLS AND EQUIPMENT*



Shock wrench



Suspension multi-tool



4-way wrench



17mm wheel wrench



8mm/4mm wrench



1.5mm "L" wrench



2.0mm "T" wrench



2.5mm ball driver



2.5mm "T" wrench



5mm "L" wrench



34-Tooth Pinion Gear
see page 28



100mph Splitter
see page 28

REQUIRED EQUIPMENT (SOLD SEPARATELY)



4 AA alkaline batteries



LiPo Balance Charger
EZ-Peak Dual recommended (part#2972)



Two battery packs with Traxxas High-Current Connectors
(Traxxas Power Cell LiPo iD batteries recommended, see page 13)

REQUIRED FOR 100MPH OPERATION (SEE PAGE 28)



- Optional Pinion Gear
- 100mph Splitter
- TQi transmitter with Traxxas Link™ Wireless Module
- Internet-enabled Apple® iPhone®, iPad®, iPod touch®, or Android™ device (*sold separately*)
- Traxxas Link application



For more information on batteries, see *Use the Right Batteries* on page 13.





Recommended Equipment
These items are not required for the operation of your model, but are a good idea to include in any R/C toolbox:

- Safety glasses
- Traxxas Ultra Premium Tire Glue, part #6468 (CA glue)
- Hobby knife
- Side cutters and/or needle nose pliers
- Philips screwdriver
- Soldering iron

*Equipment style are subject to change and may vary from images.

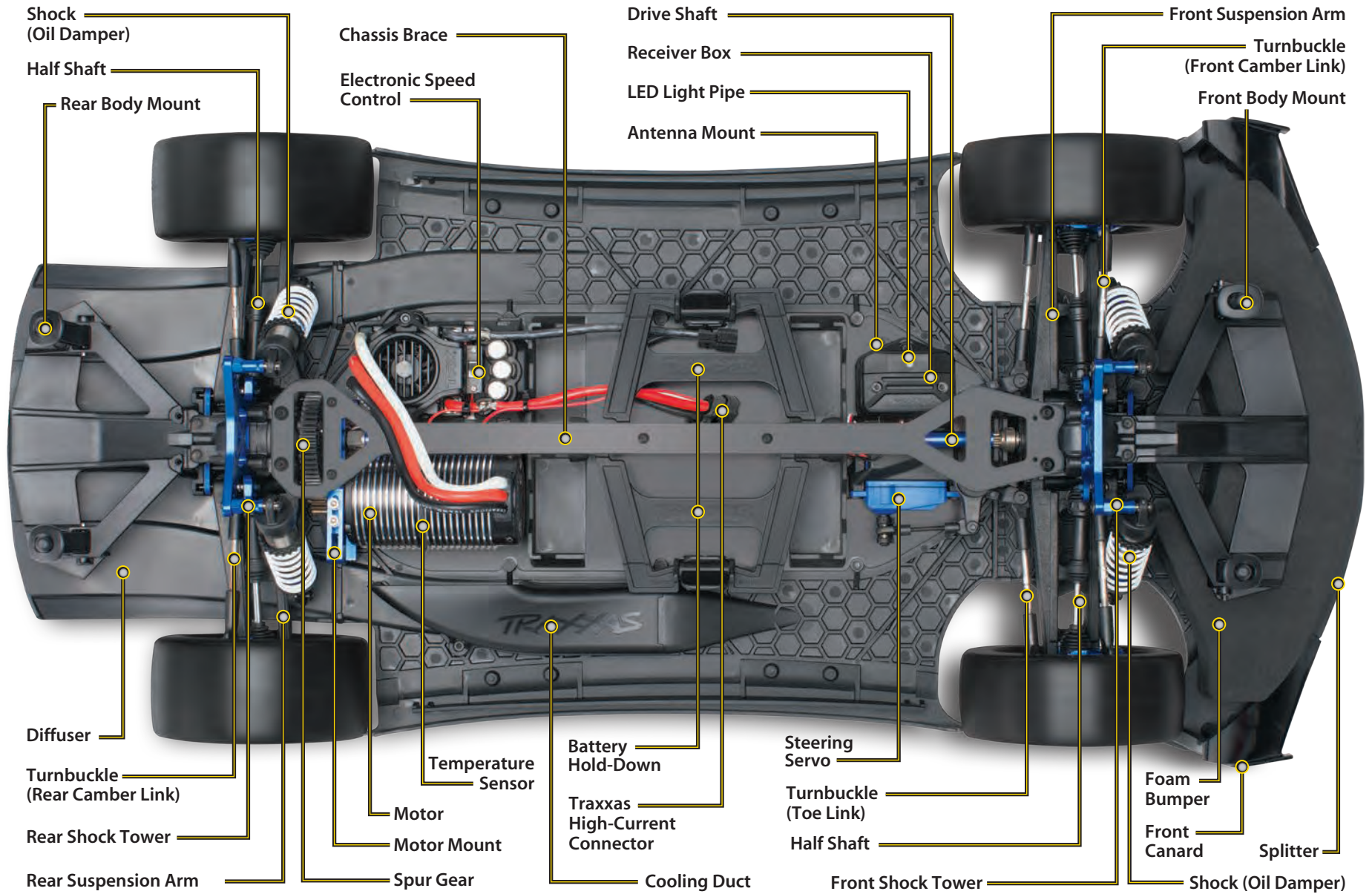
ANATOMY OF THE XO-1



 The following guide is an overview of the procedures for getting your model running. Look for the Quick Start logo on the bottom corners of Quick Start pages.

1. Read the safety precautions beginning on page 3

For your own safety, understand where carelessness and misuse could lead to property damage, fire, personal injury, or death. Safety is your responsibility.

2. Charge two battery packs • See page 13

Your model requires two battery packs and a compatible battery charger. LiPo batteries are recommended for the best performance. Never use a NiMH or NiCad charger to charge LiPo batteries.

3. Install batteries in the transmitter • See page 13

The transmitter requires 4 new AA alkaline batteries.

4. Install the battery packs in the model • See page 14

Your model requires two fully charged battery packs.

5. Turn on the radio system • See page 15

Make a habit of turning the transmitter on first, and off last.

6. Check servo operation • See page 16

Make sure the steering servo is working correctly.

7. Range test the radio system • See page 16

Follow this procedure to make sure your radio system works properly at distance and that there is no interference from outside sources.

8. Detail your model • See sidebar, page 10

Apply other decals if desired.

9. Drive your model • See page 19

Driving tips and adjustments for your model.

10. Maintaining your model • See page 23

Follow these critical steps to maintain the performance of your model and keep it in excellent running condition.



The Quick Start is NOT a substitute for reading the entire manual. The Quick Start is merely intended to direct you to sections of the manual to more quickly familiarize yourself with the basics of this model's operation. Do not run the model without thoroughly reading all of the instructions, warnings, and precautions supplied with your model. Pay particular attention to the warnings in the beginning and throughout the remainder of this manual.

Look for the Quick Start logo at the bottom of Quick Start pages.





Applying the Decals

The main decals for your model have been applied at the factory. The decals are printed on self-adhesive clear mylar and are die-cut for easy removal. Use a hobby knife to lift the corner of a decal and lift it from the backing.

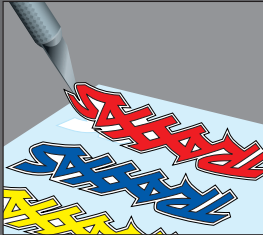

To apply the decals, place one end down, hold the other end up, and gradually smooth the decal down with your finger as you go. This will prevent air bubbles. Placing both ends of the decal down and then trying to smooth it out will result in air pockets. Look at the photos on the box for typical decal placement.

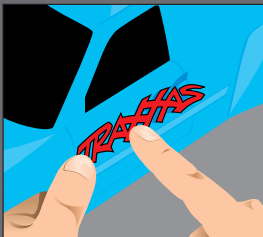

INTRODUCTION

Your model includes the latest Traxxas TQi 2.4GHz transmitter with Traxxas Link™ Model Memory. The transmitter's easy-to-use design provides instant driving fun for new R/C enthusiasts, and also offers a full complement of pro-level tuning features for advanced users – or anyone interested in experimenting with the performance of their model. The steering and throttle channels feature adjustable Exponential, End Points, and Sub-Trims. Steering and braking Dual Rate are also available. Many of the next-level features are controlled by the Multi-Function knob, which can be programmed to control a variety of functions. The detailed instructions (page 31) and Menu Tree (page 34) included in this manual will help you understand and operate the advanced functions of the new TQi radio system. For additional information and how-to videos, visit Traxxas.com.

RADIO AND POWER SYSTEM TERMINOLOGY

Please take a moment to familiarize yourself with these radio and power system terms. They will be used throughout this manual. A detailed explanation of the advanced terminology and features of your new radio system begins on page 31.

2.4GHz Spread Spectrum – This model is equipped with the latest R/C technology. Unlike AM and FM systems that require frequency crystals and are prone to frequency conflicts, the TQi system automatically selects and locks onto an open frequency, and offers superior resistance to interference and “glitching.”

Balance Charger – A LiPo battery contains individual cells (for example, Traxxas Power Cell LiPo 3S batteries each have three cells). A balance charger monitors the voltage of each cell and charges the cells equally. This assures maximum performance and battery life by preventing individual cells within the pack from over-charging. Traxxas recommends the EZ-Peak Plus or EZ-Peak Dual balance chargers for Traxxas Power Cell LiPo iD batteries.

BEC (Battery Eliminator Circuit) - The BEC can either be in the receiver or in the ESC. This circuit allows the receiver and servos to be powered by the main battery pack in an electric model. This eliminates the need to carry a separate pack of 4 AA batteries to power the radio equipment.

Brushless Motor - A D/C brushless motor replaces the brushed motor's traditional commutator and brush arrangement with intelligent electronics that energize the electromagnetic windings in sequence to provide rotation. Opposite of a brushed motor, the brushless motor has its windings (coils) on the perimeter of the motor can and the magnets are mounted to the spinning rotor shaft.

Cogging - Cogging is a condition sometimes associated with brushless motors. Typically it is a slight stutter noticed when accelerating from a stop. It happens for a very short period as the signals from the electronic speed control and the motor synchronize with each other.

Current - Current is a measure of power flow through the electronics, usually measured in amps. If you think of a wire as a garden hose, current is a measure of how much water is flowing through the hose.

ESC (Electronic Speed Control) - An electronic speed control is the electronic motor control inside the model. Electronic speed controls use power more efficiently than mechanical speed controls so that the batteries run longer. An electronic speed control also has circuitry that prevents loss of steering and throttle control as the batteries lose their charge.

Frequency band - The radio frequency used by the transmitter to send signals to your model. This model operates on the 2.4GHz direct-sequence spread spectrum.

kV Rating - Brushless motors are often rated by their kV number. The kV rating equals no-load motor rpm with 1 volt applied. The kV increases as the number of wire turns in the motor decreases. As the kV increases, the current draw through the electronics also increases.

LiPo – Abbreviation for Lithium polymer batteries. This type of battery chemistry provides the maximum possible performance for your model. However, LiPo batteries are not for novice users and require specific charging and handling to provide reliable and safe operation. Follow all the warnings and precautions in this manual before charging the batteries and operating your model.

mAh – Abbreviation for milliamp hour. A measure of the capacity of the battery pack. The higher the number, the longer the battery will last between recharges.

Neutral position - The standing position that the servos seek when the transmitter controls are at the neutral setting.

NiMH - Abbreviation for nickel-metal hydride, the most common radio-control battery type. NiMH packs have lower current handling ability and less capacity than LiPo packs, but are generally lower in cost and provide reliable performance.

Receiver - The radio unit inside your model that receives signals from the transmitter and relays them to the servos.

Resistance - In an electrical sense, resistance is a measure of how an object resists or obstructs the flow of current through it. When flow is constricted, energy is converted to heat and is lost.

Rotor - The rotor is the main shaft of the brushless motor. In a brushless motor, the magnets are mounted to the rotor, and the electromagnetic windings are built into the motor housing.

Sensor - Device in the model that gathers data for telemetry such as temperature, voltage or RPM.

Sensored - Sensored refers to a type of brushless motor that uses an internal sensor in the motor to communicate rotor position information back to the electronic speed control.

Sensorless - Sensorless refers to a brushless motor that uses advanced instructions from an electronic speed control to provide smooth operation. Additional motor sensors and wiring are not required.

Servo - Small motor unit in your model that operates the steering mechanism.

Telemetry - Describes the capability for the model to provide real-time information such as speed, temperature, RPMs, and voltage back to the transmitter for display.

Transmitter - The hand-held radio unit that sends throttle and steering instructions to your model.

Traxxas Link - Apple® iPhone®/iPad®/iPod touch® y Android™ application that provides access to telemetry data and adjustments in the TQi radio system. Sold separately in the Apple App StoreSM or on Google Play™.

Trim - The fine-tuning adjustment of the neutral position of the servos, made by adjusting the throttle and steering trim knobs on the face of the transmitter. **Note:** The Multi-Function knob must be programmed to serve as a throttle trim adjustment.

Thermal Shutdown Protection - Temperature sensing electronics used in the electronic speed control detect overloading and overheating of the transistor circuitry. If excessive temperature is detected, the unit automatically shuts down to prevent damage to the electronics.

2-channel radio system - The TQi radio system, consisting of the receiver, the transmitter, and the servos. The system uses two channels: one to operate the throttle and one to operate the steering.

Voltage - Voltage is a measure of the electrical potential difference between two points, such as between the positive battery terminal and ground. Using the analogy of the garden hose, while current is the quantity of water flow in the hose, voltage corresponds to the pressure that is forcing the water through the hose.

IMPORTANT RADIO SYSTEM PRECAUTIONS

- For maximum range, always point the front of the transmitter toward the model.
- Do not kink the receiver's antenna wire. Kinks in the antenna wire will reduce range.
- DO NOT CUT any part of the receiver's antenna wire. Cutting the antenna will reduce range.
- Extend the antenna wire in the model as far as possible for maximum range. It is not necessary to extend the antenna wire out of the body, but wrapping or coiling the antenna wire should be avoided.
- Do not allow the antenna wire to extend outside the body without the protection of an antenna tube, or the antenna wire may get cut or damaged, reducing range. It is recommended to keep the wire inside the body (in the antenna tube) to prevent the chance of damage.



To prevent loss of radio range, do not kink or cut the black wire, do not bend or cut the metal tip, and do not bend or cut the white wire at the end of the metal tip.

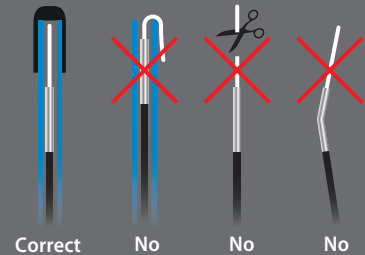



Castle Creations Motor Specifications

Type:
1717 Sensorless brushless
RPM/volt (kV): 1650
Magnet type:
Ultra High-Temperature
Sintered Neodymium
Connection type :
6.5mm bullet
Wire size: 10 Gauge
Max RPM: 45,000
Diameter: 50mm (1.97")
Length: 85mm (3.35")
Weight: 594g (20.96oz)

ESC/Motor Wiring Diagram

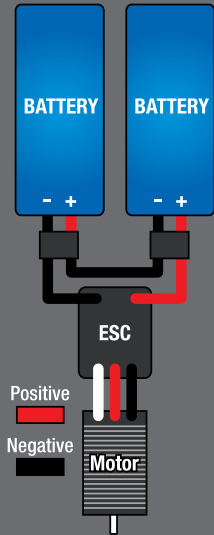

Your model is equipped with the TQi 2.4GHz transmitter with the Traxxas Link™ Wireless Module. The transmitter has two channels for controlling your throttle and steering. The receiver inside the model has 5 output channels. Your model is equipped with one servo and an electronic speed control.

TRANSMITTER AND RECEIVER



MODEL WIRING DIAGRAM

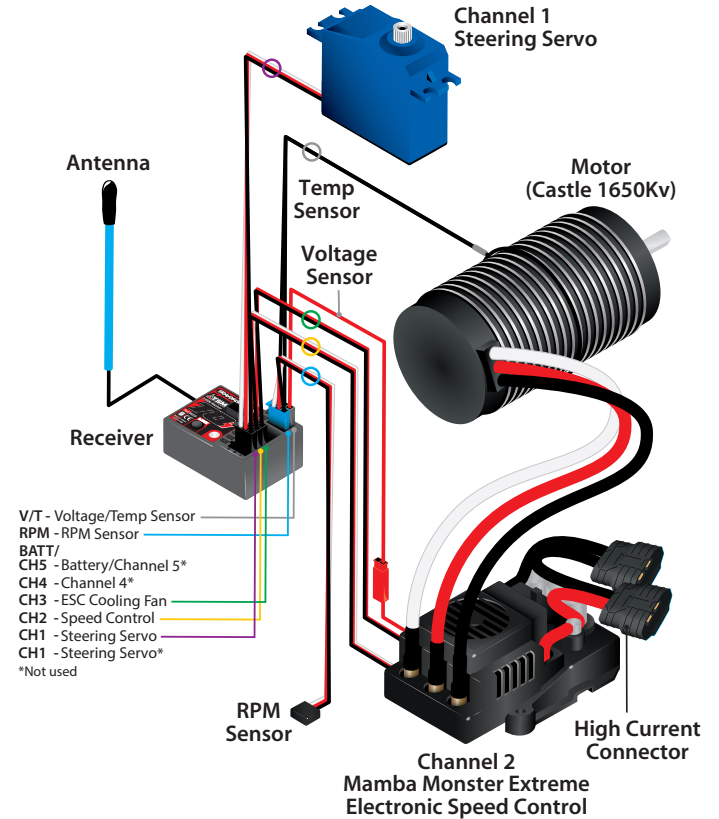

INSTALLING TRANSMITTER BATTERIES

Your TQi transmitter uses 4 AA batteries. The battery compartment is located in the base of the transmitter.



1. Remove the battery compartment door by pressing the tab and sliding the door open.
2. Install the batteries in the correct orientation, as indicated in the battery compartment.
3. Reinstall the battery compartment door and snap it closed.
4. Turn on the transmitter and check the status LED for a solid green light.

If the status LED flashes red, the transmitter batteries may be weak, discharged, or possibly installed incorrectly. Replace with new batteries. The status LED does not indicate the charge level of the battery pack installed in the model. Refer to the troubleshooting section on page 32 for more information on the transmitter status LED codes.

SELECTING BATTERIES FOR YOUR MODEL

Your model does not include batteries or a charger. Two identical batteries equipped with Traxxas High Current connectors are required. The XO-1 may be operated with NiMH batteries, but LiPo batteries will provide the best performance, and 3s LiPo batteries are required to operate the XO-1 at maximum speed. Traxxas Power Cell iD® batteries are strongly recommended for maximum performance and safer charging.

The following chart lists available Power Cell batteries for your model:

LiPo Batteries

- 2872X 5000 mAh 11.1v 3-Cell (3S) 25C LiPo Battery
- 2843X 5800 mAh 7.4v 2-Cell (2S) 25C LiPo Battery
- 2857X 6400 mAh 11.1v 3-Cell (2S) 25C LiPo Battery
- 2869X 7600 mAh 7.4v 2-Cell (2S) 25C LiPo Battery
- 2878X 8400 mAh 11.1v 3-Cell (3S) 25C LiPo Battery*
- 2854X 10000 mAh 7.4v 2-Cell (2S) 25C LiPo Battery*

*Requires TRX Battery Expansion Kit 6426X and 6427X (battery tray relocation required)



WARNING: FIRE HAZARD!

Users of Lithium Polymer (LiPo) batteries must read the Warnings and Precautions beginning on page 3. You **MUST** use a LiPo charger for LiPo batteries or battery damage with the potential for fire will result.

Note: When operating the XO-1 with 2s LiPo or NiMH batteries and stock gearing, the top speed is 35+mph. **The included optional high-speed pinion gear is not recommended for use with 2s LiPo or NiMH batteries.** You can achieve speeds of 50+mph with 2s 5000mAh or larger LiPo batteries by installing an accessory 21-tooth, Mod 1.0 (metric pitch) pinion gear.

SELECTING A CHARGER FOR YOUR MODEL

Make certain you choose the correct type of charger for the batteries you select. Traxxas recommends you choose a genuine Traxxas EZ-Peak® iD charger for safer charging and maximum battery life and performance.

Charger	Part No.	NiMH Compatible	LiPo Compatible	Battery iD	Max. Cells
EZ-Peak Plus, 4 amps	2970	YES	YES	YES	3s
EZ-Peak Live, 12 amps	2971	YES	YES	YES	4s
EZ-Peak Dual, 8 amps	2972	YES	YES	YES	3s
EZ-Peak Live Dual, 26+ amps	2973	YES	YES	YES	4s



Use the Right Batteries

Your transmitter uses AA batteries. Use new alkaline batteries (part #2914). Do not use rechargeable AA batteries to power the TQi transmitter, as they will not provide sufficient voltage for optimum transmitter performance.

Caution: Discontinue running your model at the first sign of weak batteries (flashing red light on the transmitter) to avoid losing control.



If the status LED doesn't light green, check the polarity of the batteries. If you see any other flashing signal from the LED, refer to the chart on page 32 to identify the code.





Battery Compartment Specs:

- 49.5mm (1.95") wide x 155mm (6.10") long (stock) or 135mm (5.31") long
- Height with stock strap: 23mm (.91") or 25mm (.94")

Note: There is some flex with the battery strap. It is possible to fit slightly taller batteries in the compartment.

INSTALLING & REMOVING THE BATTERY PACKS

The XO-1's battery compartments can accommodate a variety of LiPo battery configurations. From the factory, the compartments are set up for Traxxas Power Cell 5000mAh 3S packs. The number on each side of the hold-down indicates the battery height in millimeters that the hold-down can accommodate. Note that one side is labeled "23mm/38mm" and other side is labeled "25mm/40mm".



Always remove the batteries from the model before recharging.

Battery Compartment Height Chart

The chart below show the heights available through various hold-down and retainer combinations. *Parts in bold are sold separately.*

Height (mm)	Hold-Down Part Number	Retainer Part Number
20	#6426X	#6427
23	#6426	#6427
25	#6426	#6427
28	#6426X	#6427
35	#6426X	#6427X
38	#6426	#6427X
40	#6426	#6427X
43	#6426X	#6427X

Removing the Battery Packs

1. Unplug the High Current Connectors.
2. Flex the retainer away from the center of the chassis.
3. Lift up the battery hold-down, and pull it away from the chassis.
4. Repeat for the opposite battery.

Installing the Battery Packs

1. Insert the battery into the tray with the High Current Connector positioned towards the rear of the car.
2. Insert the hold-down into the lower set of holes in the center support. If you are installing Traxxas Power Cell 5000mAh 3S batteries, the hold-downs should be oriented so the side labeled "25mm/40mm" is facing up.
3. Align the hold-down over the retainer and press down until it snaps into place.
4. Repeat for the opposite battery.
5. When you are ready to drive, connect the High Current Connectors to the speed control.

Adjusting The Battery Compartment Length

The XO-1's battery compartments are configured for batteries that are 155mm long. The compartments' rear battery cup can be moved forward 20mm to accommodate 135mm battery packs. To configure the compartments for 135mm packs, remove the 3x10mm countersunk screws, and reinstall the battery cup using these screws in the rear set of holes in the battery cup.

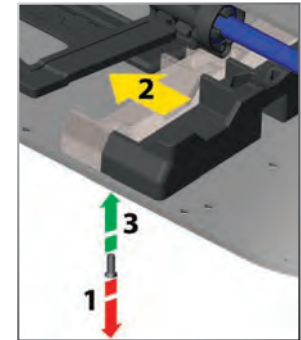

The Traxxas High Current Connector

Your model is equipped with the patented Traxxas High-Current Connector. Standard connectors restrict current flow and are not capable of delivering the power needed to maximize the output of brushless power systems.



The Traxxas connector's gold-plated terminals with a large contact surfaces ensure positive current flow with the least amount of resistance. Secure, long-lasting, and easy to grip, the Traxxas connector is engineered to extract all the power your battery has to give.



RADIO SYSTEM CONTROLS



RADIO SYSTEM RULES

- Always turn your TQi transmitter on first and off last. This procedure will help to prevent your model from receiving stray signals from another transmitter, or other source, and running out of control. Your model has electronic fail-safes to prevent this type of malfunction, but the first, best defense against a runaway model is to always turn the transmitter on first and off last.
- Always use new or freshly charged batteries for the radio system. Weak batteries will limit the radio signal between the receiver and the transmitter. Loss of the radio signal can cause you to lose control of your model.



- In order for the transmitter and receiver to bind to one another, the receiver in the model must be turned on within 20 seconds of turning on the transmitter. The transmitter LED will flash fast red indicating a failure to link. If you miss it, simply turn off the transmitter and start over.
- Always turn on the transmitter before plugging in the battery.

RADIO SYSTEM BASIC ADJUSTMENTS

Steering Trim

The electronic steering trim located on the face of the transmitter adjusts the neutral (center) point of the steering channel.

Note: Traxxas Stability Management (TSM) must be completely turned off while adjusting steering trim. See page 17 for TSM adjustments.



Multi-Function Knob

The Multi-Function knob can be programmed to control a variety of functions. From the factory, the Multi-Function knob controls Traxxas Stability Management (TSM).

For more detail on TSM, refer to page 17.



Remember, always turn the TQi transmitter on first and off last to avoid damage to your model.



Automatic Fail-Safe

The TQi transmitter and receiver are equipped with an automatic fail-safe system that does not require user programming. In the event of signal loss or interference, the throttle will return to neutral and the steering will hold its last commanded position. If Fail-Safe activates while you are operating your model, determine the reason for signal loss and resolve the problem before operating your model again.



Stop immediately at the first sign of weak batteries. Never turn the transmitter off when the battery pack is plugged in. The model could run out of control.



Using Reverse: While driving, push the throttle trigger forward to apply brakes. Once stopped, return the throttle trigger to neutral. Push the throttle trigger forward again to engage proportional reverse.

USING THE RADIO SYSTEM

The TQi Radio System has been pre-adjusted at the factory. The adjustment should be checked before running the model, in case of movement during shipping. Here's how:

1. Turn the transmitter switch on. The status LED on the transmitter should be solid green (not flashing).
2. **Elevate the model on a block or a stand so that all the tires are off the ground.** Make sure your hands are clear of the moving parts of the model.
3. Plug the battery packs in the model into the speed control.
4. Switch the model on by sliding the power switch on top of the speed control to the "on" position. The speed control will play a descending tone, then beep once for each LiPo cell it detects. With Traxxas Power Cell 3S batteries installed, the speed control will beep six times (two 3-cell batteries = 6 cells).

Do not operate your model if the number of cells you have installed does not match the number of cells detected by the speed control.

5. Turn the steering wheel on the transmitter back and forth and check for rapid operation of the steering servo. Also, check that the steering mechanism is not loose or binding. If the steering operates slowly, check for weak batteries.
6. When looking down at the model, the front wheels should be pointing straight ahead. If the wheels are turned slightly to the left or right, turn off TSM (see page 17) and slowly adjust the steering trim control on the transmitter until they are pointing straight ahead; then, return the Multi-Function knob to the desired TSM setting.
7. Gently operate the throttle trigger to ensure that you have forward and reverse operation, and that the motor stops when the throttle trigger is at neutral. **Warning: Do not apply full throttle in forward or reverse while the model is elevated.**
8. Once adjustments are made, turn the model off first (using the switch on the speed control), then turn off the transmitter.



Range-Testing the Radio System

Before each running session with your model, you should range-test your radio system to ensure that it operates properly.

1. Turn on the radio system and check its operation as described in the previous section.
2. Have a friend hold the model. Make sure hands and clothing are clear of the wheels and other moving parts on the model.
3. Walk away from the model with the transmitter until you reach the farthest distance you plan to operate the model.
4. Operate the controls on the transmitter once again to be sure that the model responds correctly.
5. Do not attempt to operate the model if there is any problem with the radio system or any external interference with your radio signal at your location.

Higher Speeds Require Greater Distance

The faster you drive your model, the more quickly it will near the limit of radio range. At 102mph, XO-1 covers 150 feet each second! It's a thrill, but use caution to keep your model in range.

No matter how fast or far you drive your model, always leave adequate space between you, the model, and others. Never drive directly toward yourself or others. Think about where the model will go if you lose control of it. Make sure there are no people or animals in those areas.

TQi Binding Instructions

For proper operation, the transmitter and receiver must be electronically 'bound.' **This has been done for you at the factory.** Should you ever need to re-bind the system or bind to an additional transmitter or receiver, follow these instructions. **Note:** the receiver must be connected to a 4.8-6.0v (nominal) power source for binding, and the transmitter and receiver must be within 5 feet of each other.

1. Press and hold the transmitter's SET button as you switch on the transmitter. The transmitter's LED will flash red slowly.
2. Press and hold the receiver's LINK button as you switch on the speed control.
3. When the transmitter and receiver's LEDs turn solid green, the system is bound and ready for use. Confirm that the steering and throttle operate properly before driving your model.

TRAXXAS STABILITY MANAGEMENT (TSM)



Traxxas Stability Management or TSM allows you to experience all the speed and acceleration that was engineered into your Traxxas model by helping you to maintain control of the vehicle in low-

traction situations. TSM helps provide straight ahead full-throttle acceleration on slippery surfaces, without fishtailing, spinouts, or loss of control. TSM also dramatically improves braking control. High speed cornering and control is also made possible as TSM makes corrections for you, without intruding on your fun, or creating unexpected side effects.

The Multi-Function knob on the TQi transmitter has been programmed to control TSM. The recommended (default) setting for TSM is to rotate the knob to the 12:00 position (the zero mark on the dial).



Turn the knob clockwise to increase assistance; turn the knob counterclockwise to decrease assistance. Turn the knob counterclockwise to its stop to turn TSM completely off.

Note: TSM is deactivated automatically when driving or braking in reverse.



When driving on surfaces with some traction, decrease the TSM setting to allow the vehicle to feel more “loose” for power sliding, drifting, and so on. On surfaces with very little traction (loose dirt, smooth concrete, ice/snow), increase TSM to maximize acceleration and control.

Drive with TSM on and off to test how it is making your control of the vehicle easier and more precise. For more information, visit Traxxas.com/tsm.

Note: TSM must be completely turned off while adjusting steering trim.

SETTING UP THE ANTENNA

The receiver antenna has been set up and installed from the factory. The antenna is secured by a 3x4mm set screw. To remove the antenna tube, simply remove the set screw with the included 1.5mm wrench.

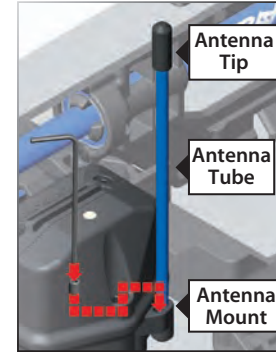

When reinstalling the antenna, first slide the antenna wire into the bottom of the antenna tube until the white tip of the antenna is at the top of the tube under the black cap. Next, insert the antenna tube into the mount while making sure that the antenna wire is in the slot in the antenna mount; then, install the set screw next to the antenna tube. Use the supplied 1.5mm wrench to tighten the screw just until the antenna tube is securely in place. Do not overtighten. **Do not bend or kink the antenna wire! See the sidebar for more information. Do not shorten the antenna tube.**

! To prevent loss of radio range, do not kink or cut the black wire, do not bend or cut the metal tip, and do not bend or cut the white wire at the end of the metal tip.

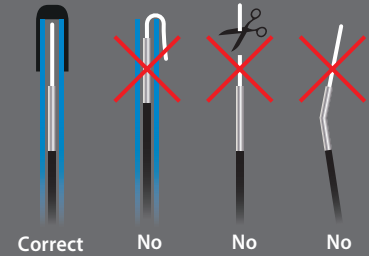



Mamba Monster Extreme Specs

Cells:
18 NiCD / NiMH 6s LiPo

Resistance:
0.0003 Ohms per phase

Brake :
Proportional with adjustable curve

Reversible:
Yes - with lockout

Low Voltage Cutoff:
Programmable

Case Size:
2.2" x 1.9" x 1.4"

Weight with Wires:
121g

Connector Type:
6.5mm bullet

Refer to the included Castle Driver's Ed Guide instruction manual for full speed control operation details.



The Castle Creations Mamba Monster Extreme speed control should not need reprogramming with normal use. However, if you install a different radio system in your model, or change the transmitter's throttle-neutral setting from 50/50 to 70/30, you will need to reprogram the speed control. Follow these instructions to reprogram the speed control:

1. Install the batteries of your choice in the battery compartment, and plug the batteries into the speed control.
2. Switch on your transmitter.
3. Hold full throttle while you switch on the Mamba Monster Extreme controller. After a few seconds, you will hear multiple tones and the RED LED will shine.
4. Hold full brake. After a few seconds, you will hear multiple tones and the YELLOW LED will shine.
5. Release the trigger to the neutral position. After a few seconds, you will hear multiple tones and ALL THE LEDs will shine.
6. Wait a few more seconds for the speed control to "arm", indicated by a double tone. You are now ready to drive.

Disconnect Batteries After Use



Warning: Risk of Fire! Always disconnect the batteries from the speed control when you are finished using your vehicle. The switch on the speed control only shuts off power to the receiver and servos. The speed control continues to draw power as long as it is plugged in and may over-discharge your batteries if they are left connected to the speed control. Over-discharging your batteries can cause the LiPo batteries to "puff," damaging them permanently. Never charge a swollen or puffed battery pack as this can cause a fire that can lead to property damage and/or personal injury or death.

Now it's time to have some fun! This section contains instructions on driving and making adjustments to your model. Before you go on, here are some important precautions to keep in mind.



The instructions that follow are for operating the model up to its electronically-limited top speed of 50mph. Additional registration, setup steps and precautions are required before operating your model at its maximum, unrestricted speed. Read, understand, and follow all the steps beginning on page 28 before unlocking your model's full-power setting and operating it at speeds over 50mph.

- Allow the model to cool for a few minutes between runs. This is particularly important when using high capacity battery packs that allow extended periods of running. Monitoring temperatures will extend the lives of the batteries and motor.
- Do not continue to operate the model with low batteries or you could lose control of it. Indications of low battery power include slow operation, sluggish servos (slow to return to center), or ESC shutdown due to the Cutoff Voltage. Stop immediately at the first sign of weak batteries. When the batteries in the transmitter become weak, the power light will begin to flash red. Stop immediately and install new batteries.
- Do not drive the model at night, on public streets, or in large crowds of people.
- If the model becomes stuck against an object, do not continue to run the motor. Remove the obstruction before continuing. Do not push or pull objects with the model.
- Because the model is controlled by radio, it is subject to radio interference from many sources beyond your control. Since radio interference can cause momentary losses of control, allow a safety margin of space in all directions around the model in order to prevent collisions.
- Use good, common sense whenever you are driving your model. Intentionally driving in an abusive and rough manner will only result in poor performance and broken parts. Take care of your model so that you can enjoy it for a long time to come.
- High performance vehicles produce small vibrations which may loosen hardware over time. Frequently check wheel nuts and other screws on your vehicle to ensure that all hardware remains properly tightened.

About Run Time

A large factor affecting run time is the type and condition of your batteries. The milliamp hour (mAh) rating of the batteries determines how large their "fuel tank" is. A 5000mAh battery pack will theoretically run twice as long as a 2500mAh sport pack. Because of the wide variation in the types of batteries that are available and the methods with which they can be charged, it's impossible to give exact run times for the model.

Another major factor which affects run time is how the model is driven. Run times may decrease when the model is driven repetitively from a stop to top-speed and with repetitive hard acceleration.

Tips for Increasing Run Time

- Use batteries with the highest mAh rating you can purchase.
- Read and follow all maintenance and care instructions provided by the manufacturer of your batteries and charger.
- Keep the electronic speed control cool. Make certain airflow to the speed control is unimpeded.
- Use the correct Cutoff Voltage setting for your battery (*refer to the included Castle Driver's Ed Guide for instructions*). Cutoff Voltage can be off for maximum NiMH battery runtime. Never use LiPo batteries while Cutoff Voltage is turned off.
- Lower your gear ratio. Installing a smaller pinion or larger spur gear will lower your gear ratio, causing less power draw from the motor and battery, and reducing overall operating temperatures.
- Maintain your model. Do not allow dirt or damaged parts to cause binding in the drivetrain. Keep the motor clean.

mAh Ratings and Power Output

The mAh rating of the battery can effect your top speed performance. The higher capacity battery packs experience less voltage drop under heavy load than low mAh rated packs. The higher voltage potential allows increased speed until the battery begins to become discharged.



DO NOT operate your model in wet conditions

Your new Traxxas model features a waterproof steering servo and receiver box, but the electronic speed control, motor, and the model itself are not waterproof or water resistant. Do not operate the model in wet conditions, including wet pavement. Do not run the model through puddles. Operating this model on wet surfaces will reduce control and may damage the electronics, resulting in loss of control.





All of the toe links are installed on the model so the left-hand thread indicators point to the same direction. This makes it easier to remember which way to turn the wrench to increase or decrease toe link length (the direction is same at all four corners). Note that the groove in the hex indicates the side of the toe link with the left-hand threads.

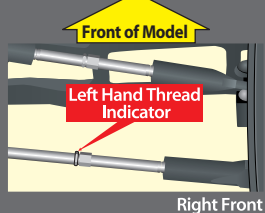
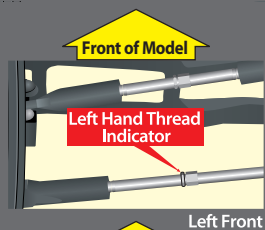

Rear toe can be adjusted by flipping the rear carriers left to right, and vice versa. Stock configuration is 3.5° of toe-in. In the optional position, toe-in is 1.5°.

Once you become familiar with driving your model, you might need to make adjustments for better driving performance

Adjusting Gear Mesh

Incorrect gear mesh is the most common cause of stripped spur gears. Gear mesh should be checked and adjusted anytime a gear is replaced, or if excessive gear noise is heard. To adjust gear mesh, follow these steps:

1. Remove the right rear wheel using the supplied 17mm wheel wrench.
2. Loosen the two 3x15 motor-mount cap screws.
3. Using your 1.5mm hex driver, turn the mesh-adjustment set screw counterclockwise to tighten the gear mesh. If needed, apply gentle pressure to the motor to help the pinion slide closer to the spur gear for a 'tighter' gear mesh. Turn the set-screw clockwise to move the pinion away from the spur gear to 'loosen' the gear mesh. When properly set, there should be just a 'tick' of free play between the pinion and spur gears.

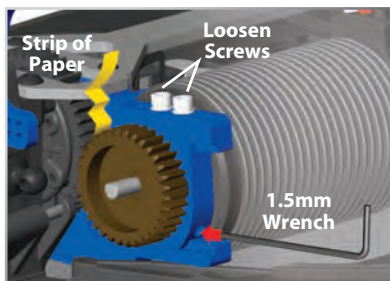

4. Tighten the two 3x15 motor-mount cap screws to hold the adjustment.

Tip: a strip of notebook paper can be inserted between the pinion and spur gears to help set gear mesh. Before tightening the motor-mount screws, insert the paper strip between the pinion and spur gear. Adjust the pinion so it is completely meshed with the spur gear, then tighten the motor mount screws. When the paper is removed, you should have the required 'tick' of free play.

Adjusting the Toe-in

Geometry and alignment specs play an important roll in your model's handling. Take the time to set them correctly. Turn off TSM (see page 17); then, set the steering trim on your transmitter to neutral. Now, adjust your servo and tie rods so that both wheels are pointing straight ahead and are parallel to each other (0° toe-in). This will ensure the same amount of steering in both directions.

For increased stability, add 1°- 2° of toe-in to each front wheel. Use the turnbuckles to adjust the alignment.



Factory Toe-In Settings

Front: 1°
Rear: 3.5° toe-in each side

Adjusting the Camber

The camber angle of both the front and rear wheels can be adjusted with the camber links (upper turnbuckles). Use a square or right-angle triangle to set the camber accurately. Adjust the front wheels to 1°- 2° of negative camber. In the rear, adjust the wheels to 1°- 2° of negative camber. These adjustments should be set with the model positioned at its normal ride height.



Factory Static Camber Settings

Front: 1° negative camber each side
Rear: 1° negative camber each side

Springs

The front and rear springs on the model have identical spring rates. The springs' pre-load can be adjusted by turning the spring pre-load adjuster. Adjusting the pre-load changes the ride height. Adjust the pre-load so that the ride height at the front of the model is 15mm, and the ride height at the rear of the model is 18mm.

Use stiffer springs to reduce bottoming out the chassis, reduce body lean, control brake dive, and provide a firmer, more responsive feel. Increasing the spring rate will increase the responsiveness of the suspension. This may be beneficial in some conditions, but may make the car feel twitchy or 'nervous' in others. Decreasing spring rate decreases the responsiveness of the suspension, making it easier to drive. When changing springs on the model it should not be necessary to re-adjust the spring pre-load. The accessory springs have been designed so the ride height should be the same before and after changing springs.

Optional springs available from Traxxas are listed below. Refer to your parts list for a complete part number listing. Higher rate springs are stiffer. Springs can be identified by stripes of color on one end.

Optional Springs

Stripe Color	Spring Rate	Stripe Color	Spring Rate
○ Double Pink	1.4 N/mm (8.0 lb/in)	○ White	2.9 N/mm (16.6 lb/in)
● Double Blue	1.6 N/mm (9.1 lb/in)	● Orange	3.2 N/mm (18.3 lb/in)
● Double Green	1.8 N/mm (10.3 lb/in)	● Green	3.5 N/mm (20 lb/in)
● Double Black	2.0 N/mm (11.4 lb/in)	● Gold	3.8 N/mm (21.7 lb/in)
● Double Purple	2.3 N/mm (13.1 lb/in)	● Tan	4.1 N/mm (23.4 lb/in)
● Yellow	2.6 N/mm (14.8 lb/in)	● Black	4.4 N/mm (25.1 lb/in)

All above springs are red springs. Stock springs are 1.6N/mm white springs.

Ride Height

Ride height can be adjusted by turning the spring pre-load adjusters on the shock bodies. Turn the adjusters to the left to raise the ride height. Turn them to the right to lower the ride height. When adjusting spring pre-load, be sure to change the adjustment equally on the left and right sides so the suspension remains balanced. Optimum ride height is 15mm clearance between the front of the chassis and the ground, and 18mm between the rear of the chassis and the ground. Always set the ride height so the chassis has a slight forward rake, with the rear ride height slightly higher than the front ride height.

Lower Shock Mounting Positions

In the out-of-the-box configuration, the shocks are installed in the furthest hole out on the front and rear suspension arms. It is not recommended to alter the shock position on the control arm. The shocks have been internally limited (front only) and spring rates chosen to work perfectly with the hole position in the suspension arm.

Upper Shock Mounting Positions

The upper shock mounting positions can be used to provide small changes in the suspension stiffness when changing spring rates is too drastic of a change. Placing the upper shock mount inwards on the shock tower one hole will soften the suspension slightly. Be careful to recheck your ride height as this adjustment will change the ride height of the vehicle.

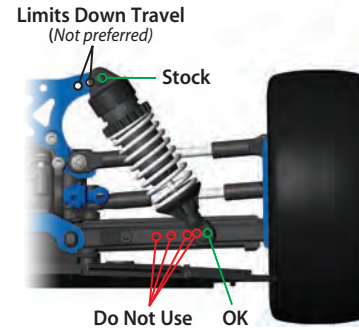

Shock Oil

The 4 oil-filled shocks (dampers) effectively control the suspension movement by preventing the wheels and tires from continuing to "bounce" after rebounding from a bump. Changing the oil in the shocks can vary the suspension damping effect. Changing the oil to a higher viscosity oil will increase damping. Lowering the viscosity of the oil will cause the suspension damping to be reduced. Damping should be increased (with higher viscosity oil) if the model is bottoming easily over rougher surfaces. Damping should be decreased (with thinner viscosity oil) if the model is hopping over small bumps and feels unstable. The viscosity of shock oil is affected by extremes in operating temperature; an oil of certain viscosity will become less viscous at higher temperatures and more viscous at lower temperatures. Operating in regions with cold temperatures may require lower viscosity oil.

From the factory, the shocks are filled with SAE-80W silicone oil. Only use 100% silicone oil in the shock.

Replacing Shock Oil

For easier service, the shocks should be removed from the vehicle and disassembled to change the oil.

1. Remove the lower spring retainer and shock spring.
2. Remove the upper shock cap using the shock wrench and suspension multi tool.



Important: The shocks are assembled at the factory with a center-to-center distance (between the rod end balls) of 87mm front and 83mm rear. Any time the shocks are removed and disassembled, this distance should be checked to ensure proper operation of the suspension.



Shock Piston Sizes

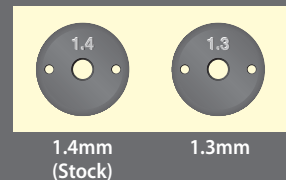



The Power System is NOT WATERPROOF. Do not expose the power system to any type of water, condensation, or moisture.

3. Empty the used shock oil from the shock body.
4. Fill the shock with new silicone shock oil up to the top of the shock body.
5. Slowly move the piston up and down (always keeping it submerged in oil) to release the air bubbles. Let the shock sit for a few minutes to allow any remaining air bubbles to surface.
6. Slowly thread the upper cap with the installed shock bladder onto the shock body with the suspension multi tool. The excess oil will bleed out of the small hole in the shock cap.
7. Tighten the shock cap until snug. Use the included steel shock wrench to hold onto the shock body while tightening.

Centering Your Servo

If you have removed the servo horn from your model's steering servo, or the servo has been removed for service or cleaning, the servo must be re-centered prior to installation of the servo horn or installation of the servo in the model.

1. Remove the servo horn from the steering servo.
2. Connect the steering servo to channel 1 on the receiver. Connect the electronic speed control (ESC) to channel 2. The white wire on the servo lead is positioned towards the receiver's LED.
3. Turn the transmitter power switch on. Make certain the transmitter's batteries are not depleted.
4. Turn off TSM (see page 17).
5. Turn the transmitter's steering trim knob to the center "0" position.
6. Disconnect the black and white motor wires to prevent the motor from turning during the next steps. Connect a fresh battery pack to the speed control and turn on the ESC. The servo's output shaft will automatically jump to its center position.
7. Install the servo horn onto the servo output shaft. The servo horn should face toward the center of the chassis and be perpendicular to the servo body.
8. Check servo operation by turning the steering wheel back and forth to ensure that the mechanism has been centered properly and you have equal throw in both directions. Use the transmitter's steering trim knob to fine-tune the position of the servo horn so the model tracks straight when the steering wheel is at neutral.

RECEIVER BOX: MAINTAINING A WATERTIGHT SEAL Removing and Installing Radio Gear

The unique design of the receiver box allows the removal and installation of the receiver without losing the ability to maintain a watertight seal in the box. The patent-pending wire clamp feature gives you the ability to also install aftermarket radio systems and maintain the watertight features of the receiver box.

Removing the Receiver

1. Remove the wire clamp by removing the two 2.5x8mm cap screws.
2. To remove the cover, remove the two 3x10mm button-head cap screws.
3. Unplug the servo cables from the receiver and remove the receiver.

Receiver Installation

1. Thread the servo wires and antenna through the cover.
2. Using double-sided adhesive foam tape, install the receiver into the box.

Note: For best performance, it is recommended that the receiver be installed in the original orientation as shown.

3. Install the cover onto the box making sure the O-ring is properly seated into the groove in the receiver box so that the cover will not pinch it or damage it in any way.
4. Install the cover and tighten the 3x10mm button-head cap screws securely.
5. Push the extra servo wires into the box.
6. Install the wire clamp and secure with the two 2.5x8mm cap screws.



If you have questions or need technical assistance, call Traxxas at

1-888-TRAXXAS

(1-888-872-9927) (U.S. residents only)

Your model requires timely maintenance in order to stay in top running condition. **The following procedures should be taken very seriously.**

Frequently inspect the vehicle for obvious damage or wear. Look for:

1. Cracked, bent, or damaged parts.
2. Check the wheels and steering for binding.
3. Check the operation of the shock absorbers.
4. Check the wiring for any frayed wires or loose connections.
5. Check the mounting of the receiver and servo(s) and speed control.
6. Check the tightness of the wheel nuts with a wrench.
7. Check the operation of the radio system, especially the condition of the batteries.
8. Check for any loose screws in the chassis structure or suspension.
9. Check the operation of the steering servo and ensure that it is not binding.
10. Inspect the gears for wear, broken teeth, or debris lodged between the teeth.
11. Check the tires to make sure they are firmly bonded to the wheels.
12. Check tires for excessive wear. Replace the tires if the inner belting is exposed.
13. Check the antenna wire for any kinks or damage that could shorten the radio range.

Other periodic maintenance:

- **Cush Drive™:** The Cush Drive system does not require maintenance, but it should be inspected periodically. If the Cush Drive develops play (spur gear movement that does not also move the drive shaft), disassemble the Cush Drive and inspect the elastomer element (part #6465) for damage and replace if necessary.
- **Chassis:** Keep the chassis clean of accumulated dirt and grime. Periodically inspect the chassis for damage.
- **Suspension:** Periodically inspect the model for signs of damage such as bent or dirty suspension pins, bent turnbuckles, loose screws, and any signs of stress or bending. Replace components as needed.
- **Steering:** Over time, you may notice increased looseness in the steering system. The tie rod ends may wear out from use (parts #2742 and #5525). Replace these components as needed to restore factory tolerances.



• **Motor temp sensor:**

The motor temperature sensor is installed at the factory to provide accurate telemetry data and thermal overload protection for the motor. If you remove the temperature sensor for vehicle maintenance, be certain to reinstall it correctly. The sensor should be installed so the thermistor (the small component at the top of the temperature sensor loop) is on the 'top' of the motor (the side where the wires exit the motor). The sensor should also be centered on the motor. To find the center of the motor, simply count eleven cooling fins from either end of the motor. If the sensor is installed incorrectly, inaccurate or false readings will be sent to the speed control, and your model's performance may be compromised. **Do not operate the XO-1 without the temperature sensor. If the sensor is missing or incorrectly installed, overheating and permanent motor damage may occur. Damage caused by overheating is not covered by the limited warranty.**



- **Shocks:** Keep the oil level in the shocks full. Use only 100% pure silicon shock oil to prolong the life of the seals. If you are experiencing leakage around the top of the shock, inspect the bladder in the top cap for signs of damage or distortion from overtightening. If the bottom of the shock is leaking, then it is time for a rebuild. The Traxxas rebuild kit for two shocks is part #5562.
- **Driveline:** Inspect the driveline for signs of wear such as worn drive yokes, dirty axle half shafts, and any unusual noise or binding. Inspect driveshafts for cracks or twisting. The dustboots must remain intact. All CV joints must rotate smoothly. Inspect the spur gear for wear and check the tightness of set screws in the pinion gears. Tighten, clean, or replace components as needed.

Storage

When you are through running the model for the day, blow it off with compressed air or use a soft bristled paint brush to dust-off the vehicle.

Always lock the power system and disconnect and remove the battery from the model whenever the model is stored. If the model will be stored for a long time, then also remove the batteries from the transmitter.



Always wear eye protection when using compressed air or spray cleaners and lubricants.



High performance vehicles generate small vibrations while driving. These vibrations may loosen hardware over time and require attention. Always check your wheel nuts and other hardware and tighten or replace when necessary.



Always use the proper length motor bolts. The standard motor mounting bolts are 4x12mm. Using motor bolts that are too long can interfere with the motor's rotation and damage the motor's internals!

Suspension and Cush Drive Assembly removal

Your model was designed with ease of disassembly in mind. The entire front and rear suspension assemblies can be removed from the chassis fully intact with the removal of only a few screws. Refer to the exploded views included in the Service and Support Guide for complete assembly diagrams.

- **Removing the front suspension module**

1. Remove the four 4x15 countersunk screws from the underside of the chassis.
2. Remove the two 4x18 button head screws from the front of the chassis brace.
3. Remove the 3x15 button head screws from the steering servo horn.
4. Pull the front suspension assembly away from the chassis.

- **Removing the rear suspension module
(Cush Drive Assembly removal)**

1. Remove the two 3x25 countersunk screws from the underside of the chassis.
2. Remove the two 3x15 countersunk screws from the underside of the chassis.
3. Remove the two 4x12 button head screws from the chassis brace.
4. Pull the rear suspension assembly away from the chassis.
5. Remove the Cush Drive (removing the two 3x10 button head screws that thread into the motor mount through the chassis brace may help flex the chassis brace out of the way).

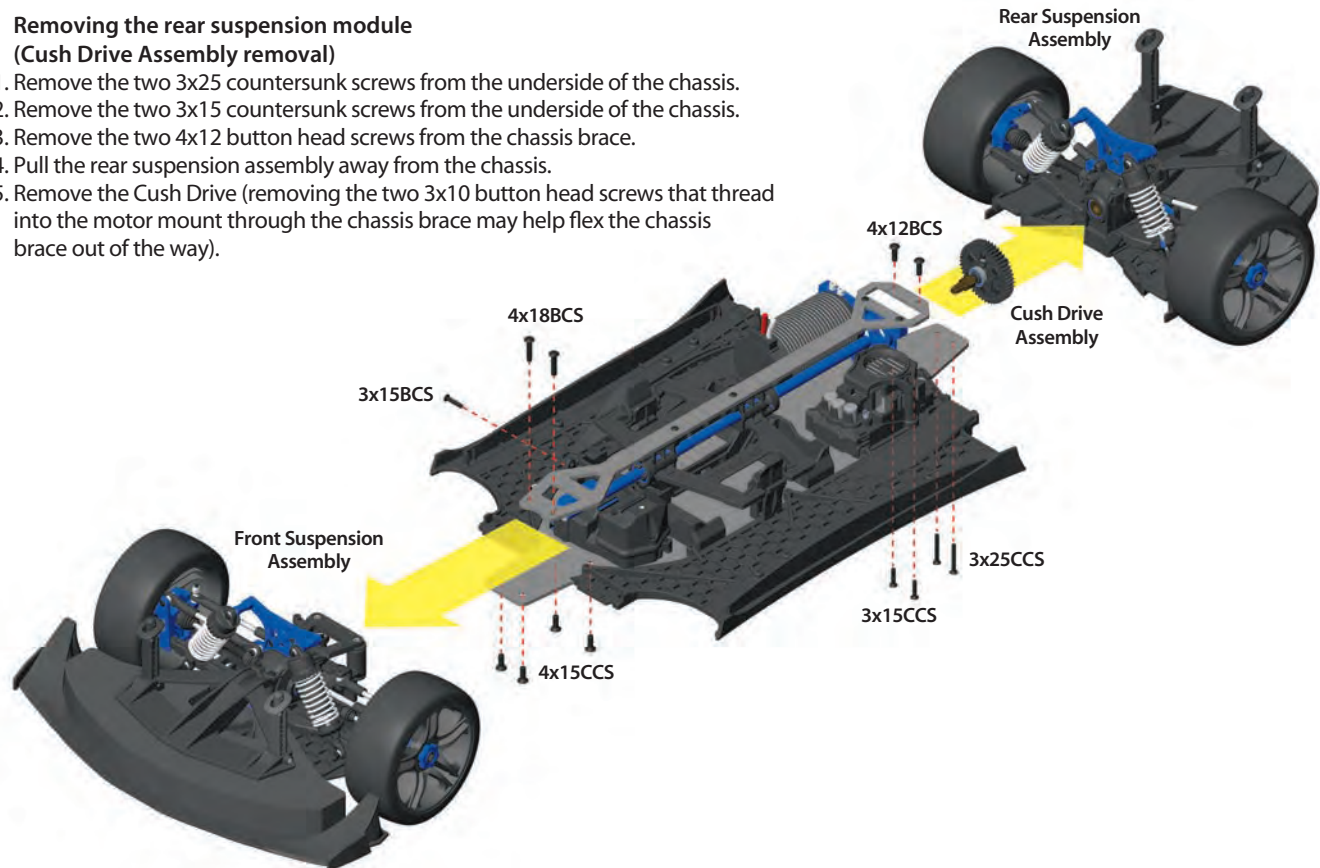

CAMBER GAIN

Your model has provisions for adjusting the camber gain geometry of the front and rear suspension. “Camber gain” refers to an increase in camber angle as the suspension is compressed. The camber gain of the vehicle can be changed inside or outside by moving the camber link attachment to a different horizontal mounting position. Adjusting the camber gain will alter the tire contact patch as the suspension is compressed. Making the camber link shorter (outside holes) will increase the camber gain. This makes the vehicle more stable over bumps, but reduces traction on smooth surfaces. Lengthening the camber links (inside holes) has the opposite effect.

• Front Camber Gain

To increase the camber gain on the front suspension, move the inner camber link ends out to Position 1. Position 2 is the stock setting.

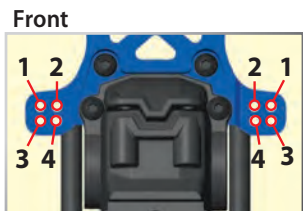

• Rear Camber Gain

To increase the camber gain on the rear suspension, move the inner camber link ends out to Position 3. Position 4 is the stock setting.

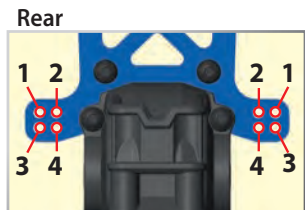

Once you make adjustments to the camber gain, re-adjust the static camber to the original specifications (page 20).

ROLL CENTER

Your model has provisions for adjusting the roll center geometry of the front and rear suspension. Roll center refers to the virtual axis around which the chassis will roll when subjected to cornering forces. The roll center of the vehicle can be raised by mounting the inner ends of the camber links in a lower position. Raising the roll center will effectively increase the roll stiffness of the vehicle (similar to installing swaybars). Adding roll resistance to one end of the vehicle will tend to add traction to the opposite end. For example, increasing roll resistance in the rear will provide more traction for the front wheels and potentially

more steering. Raising the roll center on the front and rear equally will increase overall roll resistance without changing the handling balance. The default factory locations are designed to make the model easier and more forgiving to drive and less likely to oversteer in turns.

• Front Roll Center

To lower the roll center on the front suspension, raise the inner camber link ends from position 4 to position 2, or from position 3 to position 1.

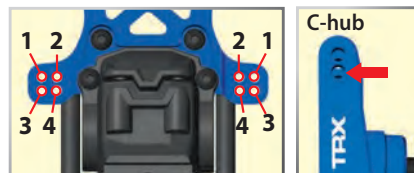

To lower the roll center further, move the outer camber link ends to the lower position on the C-hub.

• Bump Steer Correction

“Bump steer” refers to unwanted steering inputs caused by suspension movement. Your model’s suspension geometry is designed to minimize bump-steer. If you are using the upper hole on the C-hub (image A) and either of the two lower holes on the shock tower (positions 3 or 4 in “Front” image), the tie rod ball should be oriented with the large flat end on top (stock position - image B). When using any other combination of camber link attachment points, the tie rod ball should be oriented with the large flat end on the bottom (C).

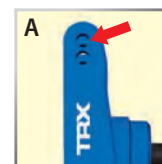

• Rear Roll Center

To lower the roll center on the rear suspension, raise the inner camber link ends from position 4 to position 2, or from position 3 to position 1.

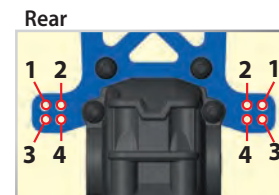

Once you make adjustments to the roll center, re-adjust the static camber to stock specifications (page 20).

Gearing Compatibility Chart:

The chart below shows recommended gear combination ranges for your model.

		Spur Gear		
		46	50	54
Pinion Gear	11	-	12.94	13.97
	12	-	11.86	12.81
	13	10.07	10.95	11.82
	14	9.35	10.16	10.98
	15	8.73	9.49	10.25
	16	8.18	8.89	9.61
	17	7.70	8.37	9.04
	18	7.27	7.91	8.54
	19	6.89	7.49	8.09
	20	6.55	7.12	7.68
	21	6.23	6.78	7.32
	22	5.95	6.47	6.99
	23	5.69	6.19	6.68
	24	5.46	5.93	6.40
	25	5.24	5.69	6.15
	26	5.04	5.47	5.91
	27	4.85	5.27	5.69
28	4.68	5.08	5.49	
29	4.51	4.91	5.30	
30	4.36	4.74	-	
31	4.22	4.59	-	
32	4.09	4.45	-	
33	3.97	4.31	-	
34	3.85	-	-	

- Stock Out of Box Setup, 50mph with 3S LiPo batteries.
- Fits, but extended running is not recommended. See warnings!
- Included optional gearing, for high-speed running only, 100mph. Not recommended for use with 2S LiPo or NiMH batteries.
- Does not fit.
- Fits, will reduce top speed but increase run time.

GEARING

Changing the gearing allows you to fine tune the speed of the model and control the temperatures of the battery packs and motor. Use a lower gear ratio (numerically larger) to reduce current draw and temperatures. Use a higher gear (numerically lower) to increase top speed. Use the following formula to calculate the overall ratio for combinations not listed on the gear chart:

$$\frac{\text{\# Spur Gear Teeth}}{\text{\# Pinion Gear Teeth}} \times 2.85 = \text{Final Gear Ratio}$$

When using higher gear ratios, it is important to monitor the temperatures of the battery and motor. If the battery is extremely hot (150°F), and/or the motor is too hot to touch (200°F), your model is probably over-gearred and drawing too much current. This temperature test assumes that the model is close to factory stock weight and operates freely with no excessive friction, dragging, or binding, and the battery is fully charged and in good condition. **Note:** Check and adjust gear mesh if a spur and/or pinion gear is changed.

This model is equipped with a Traxxas/Castle Creations Big Block motor. The gear combination that comes stock on each model provides good overall acceleration and top speed. If you want more top speed, install the included optional large pinion gear (more teeth). **The included optional large pinion gear is intended for high-speed running ONLY! This gearing is not recommended for repetitive starting and stopping.**

Repetitive starting and stopping with the high-speed gear will result in motor overheating. The speed control's thermal overload protection system will shut down power in the event of severe overheating. The model will operate normally once the speed control reaches safe operating temperature. To prevent motor overheating, only use recommended gearing and only drive in the manner prescribed for those gear ratios.

Warning! Do not drive the model at lower speeds in a confined space, with repetitive starting and stopping, with the gear ratios in the yellow and red zones shown in the chart at left. This will cause the motor to overheat, resulting in permanent damage to the motor. **Overheating is not covered by the limited warranty.** A thermal overload sensor is installed to help protect against catastrophic overheating. The speed control will flash its red and yellow LEDs to indicate the motor is being overheated, but this should not be relied upon as an absolute failsafe.

TUNING THE SEALED GEAR DIFFERENTIALS

The action of the your model's front and rear gear differentials can be tuned for different driving conditions and performance requirements, without major disassembly or removal of the suspension system.

From the factory, the differentials are sealed to maintain consistent long-term performance. Changing the oil in the differential with either lower or higher viscosity oil will vary the performance characteristics of the differentials. Changing to a higher viscosity oil in the differential will reduce the tendency for motor power to be transferred to the wheel with the least traction. You may notice this when making sharp turns on slick surfaces. The unloaded wheels on the inside of the turn have the least traction and tend to spin up to extremely high rpms. Higher viscosity (thicker) oil causes the differential to act like a limited-slip differential, distributing more equal power to the left and right wheels.

Your model will generally benefit from higher viscosity oil when being driven on low traction surfaces. **Note:** Heavier oil will allow power to be transferred even with one or more tires off the ground. This can make the vehicle more likely to overturn on high-traction surfaces.

From the factory, the front differential is filled with SAE 100,000W viscosity silicone oil. The rear differential is filled with SAE 10,000W.

Only use silicone oil in the differentials. Traxxas offers SAE 10,000W, 30,000W, and 50,000W viscosity oil (see your parts list). The differentials have to be removed from the vehicle and disassembled to change/replace oil.

Follow the steps below to access and refill the front and rear differentials:

Front differential:

1. Remove the three 4x15mm countersunk screws that fasten the body mount to the splitter.
2. Remove the two 4x30mm countersunk screws from the underside of the chassis.
3. Remove the 3x15mm button head screws that fasten the body mount to the differential case. Set the body mount aside.
4. Remove the 3x15mm button head screw from the front tie bar and remove the tie bar from the vehicle.

Front Differential Removal

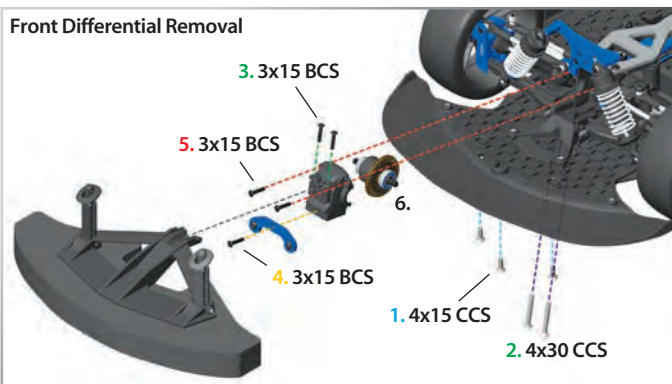

5. Remove the two 3x15mm button head screws from the differential cover and set the differential cover aside.
6. Remove the two screw pins that fasten the driveshafts to the differential output.
7. Installation is the reverse of above.

Rear differential:

1. Remove the two 3x25mm countersunk screws from the underside of the chassis.
2. Remove the two 3x15mm button head screws from the differential case, set the splitter/rear body mount assembly aside.
3. Remove the 3x15mm button head screw from the rear tie bar and set aside.

Rear Differential Removal

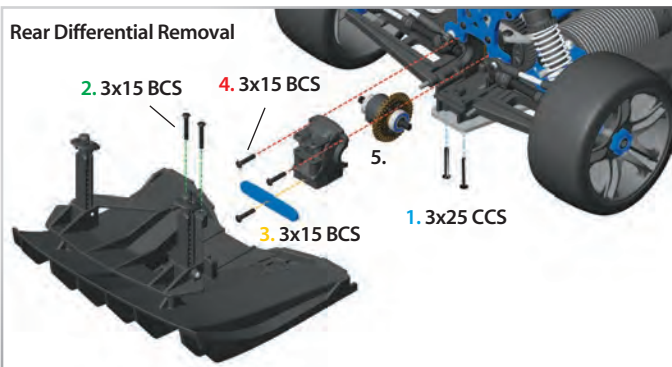

4. Remove the two 3x15mm button head screws from the differential cover and set the differential cover aside.
5. Remove the two screw pins that fasten the driveshafts to the differential output.
6. Installation is the reverse of above.

Refilling the differential:

1. Remove the four 2.5x12mm screws from the differential case and carefully pull the differential case halves apart. Work over a towel to collect any fluid that drips from the differential.
2. Drain the fluid from the differential. You may wish to remove the spider gears from the differential to make this easier.
3. Place the spider gears back into the differential case, if you removed them. Fill the differential case with fluid until it the spider gears are submerged half way.
4. Rejoin the differential case halves, using care to align the screw holes. Be sure the rubber gasket is in place, or the differential may leak.
5. Install the 2.5x12mm screws and tighten securely.



If you have questions or need technical assistance, call Traxxas at

1-888-TRAXXAS

(1-888-872-9927) (U.S. residents only)

WARNING!
RISK OF INJURY OR DEATH



Experts Only! This product is not a toy. This product carries our highest skill level rating, 10, and is not intended for use by children or minors under the age of 16. Individuals under the age of 18 require responsible adult supervision during operation and maintenance. The XO-1 is only intended to be owned and operated by experienced users with advanced skills and expert driving ability. Responsibility, maturity, and common sense are required. This model must be treated with absolute respect and caution to ensure the safety of yourself and others around you. It must only be driven at its top speed on a closed course such as a racetrack or drag strip where there are safety barricades and pedestrian access controls. Operating the XO-1 in a careless, unsafe manner, without adequate care and preparation, can result in collisions with catastrophic consequences such as serious injury or death. Know your limits. Be honest with yourself about your true ability and be certain you have a location where you can safely run the model.

Now that you are familiar with the operation of the XO-1 in “out-of-the-box” trim, it’s time to explore the upper limits of its performance capability. *Before you unlock the power system and outfit your model for full-power operation, make certain you have fully read and understand the warnings and precautions starting on page 3.*

If you have questions about the XO-1, please contact Traxxas at 1-888-TRAXXAS or e-mail us at support@Traxxas.com

Installing the High-Speed Pinion

1. Remove the right rear wheel. This will make it easier to adjust the gear mesh.
2. Remove the right rear shock’s upper mounting screw and pivot it away from the chassis to allow clearance for the pinion when you remove the motor.
3. Remove the 3x8mm cap screw and lift the motor cooling duct off the chassis.
4. Remove the 3x15mm cap screws and slide the motor out of the motor mount. You do not need to unplug the motor from the speed control or remove the motor temperature sensor.
5. Loosen the 4x4mm set screw in the pinion and slide the pinion off the motor’s output shaft.
6. Install the high-speed pinion on the motor’s output shaft. Do not tighten the set screw yet.
7. Turn the shaft so the pinion’s set screw faces up. With the 2mm driver installed in the pinion’s set screw, slide the pinion toward the motor mount until the driver fits into the slot in

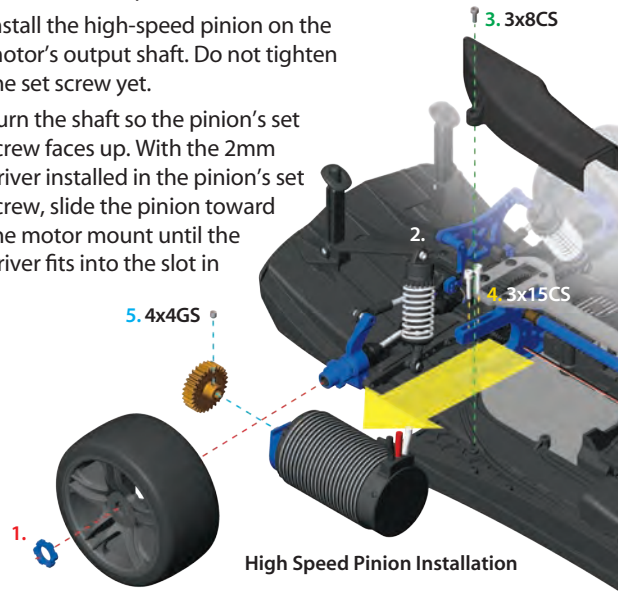

the motor mount. This sets the pinion’s offset from the motor for proper mesh with the spur gear. Tighten the set screw.

8. Reinstall the motor and cooling duct. Follow the steps on page 20 to properly set the gear mesh.

Installing the 100mph Splitter

The 100mph splitter with canards is required for 100mph running. DO NOT run the XO-1 at 100mph without the splitter. It provides downforce and stability. Failure to install the 100mph Splitter may result in a loss of control at high speed.

Remove the two 3x10mm countersunk screws and the center 4x15mm countersunk screws that attach the splitter extension to the splitter mount. Loosening the two outer 4x15mm countersunk screws attaching the front body mount to the splitter mount will aid in removing the splitter extension. Remove the splitter extension and store it with the other accessories for your model. Install the 100mph splitter extension and reinstall the 3x10mm and 4x15mm screws. Retighten the outer 4x15mm screws to complete the installation.

Stock Splitter Removal



100mph Splitter Installation



Unlocking the Power System for 100mph Running

The XO-1 is “locked” to limit its top speed to 50mph. To access the model’s full power capability and 100+mph top speed, you must “unlock” the power system. *This requires an internet-enabled Apple® iPhone®, iPad®, iPod touch®, or Android™ device; the Traxxas Link™ application (available in the Apple App StoreSM or on Google Play™); and a valid e-mail address that you can access.*

Follow the steps below to unlock the speed control:

1. Download and install the Traxxas Link application from the App Store.
2. Open the Traxxas Link application and touch the *Unlock* icon. Follow the prompts to register your model. You will be asked to accept the terms of use and provide an e-mail address. Make certain you can access the address you provide.
3. The application will send you an e-mail to confirm your registration information. Open the e-mail and follow the confirmation link.
4. The Traxxas Link application will now permit you to unlock the power system’s full power capability. Touch the *Unlock* icon to unlock the model.

You may lock the power system at any time without a connection to the internet. Lock the power system anytime the model will be stored to prevent top speed access by unauthorized drivers. You will need your e-mail address and an internet connection to unlock the power system again later. Supplying your e-mail address will prevent you from having to re-register the product.

Pairing the TQi Transmitter with Traxxas Link Wireless Module and the Traxxas Link App for the first time:

1. Turn the transmitter switch on.
2. Open the Traxxas Link App on your mobile device. Touch the Garage button, and then touch the Wireless Module button (A).

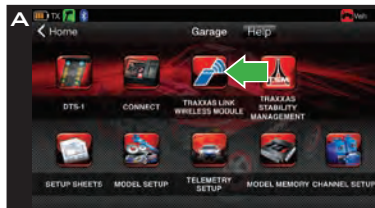

3. Press the button on the Traxxas Link Wireless Module. The blue LED on the module will blink (B).
4. Within 10 seconds, touch the “Search for Traxxas Link Wireless Module” button on your mobile device (C).



5. The Bluetooth® icon in the status bar will turn blue, and the blue LED on the module will glow solid blue (D).



6. The Traxxas Link Wireless Module and the Traxxas Link App are now paired, and will automatically connect when the transmitter is turned on and the app is running.

DRIVING 100MPH

The XO-1 is the world’s first Ready-To-Race radio controlled car, capable of speed that exceeds 100mph. **Driving at 100mph should never be done casually or without careful thought and preparation. Operating the XO-1 in a careless, unsafe manner without adequate care and preparation can result in collisions with catastrophic consequences, such as serious injury or death. Know your limits and act accordingly.**

ALWAYS confirm each item on this checklist before operating your vehicle at maximum speed.

- Complete the inspection steps on page 23.
- Confirm the tires are firmly bonded to the rims and not excessively worn.
- Confirm you are on a **closed course** that is free of bystanders, vehicles, and obstructions.
- Confirm you have adequate radio range by performing a range test as described on page 16.
- Confirm the air is calm. **Do not attempt full-speed operation in windy conditions.**
- Operate the vehicle from a location that is off of the running surface. Choose a location that allows you to stand behind a wall or other barricade.



To experience all the features of the TQi transmitter with the Traxxas Link Wireless Module, you will need an Apple iPhone (4S and later versions), iPod touch (5th generation and later versions), iPad (3rd generation and later versions), iPad mini, or Android device (4.4 and later versions). You will also need the Traxxas Link application, which you can download from the Apple App Store or Google Play.

Download Now!



Apple, the Apple logo, iPhone, iPad, iPod touch, and iTunes are trademarks of Apple Inc., registered in the U.S. and other countries. App Store is a service mark of Apple Inc. Android and Google Play are trademarks of Google Inc.

The Bluetooth word mark and logos are registered trademarks owned by Bluetooth SIG, Inc., and any use of such marks by Traxxas is under license. Other trademarks and trade names are those of their respective owners.

WARNING!

RISK OF INJURY OR DEATH



Experts Only! This product is not a toy. This product carries our highest skill level rating, 10, and is not

intended for use by children or minors under the age of 16. Individuals under the age of 18 require responsible adult supervision during operation and maintenance. The XO-1 is only intended to be owned and operated by experienced users with advanced skills and expert driving ability. Responsibility, maturity, and common sense are required. This model must be treated with absolute respect and caution to ensure the safety of yourself and others around you. It must only be driven at its top speed on a closed course, such as a racetrack or drag strip, where there are safety barricades and pedestrian access controls. Operating the XO-1 in a careless, unsafe manner without adequate care and preparation can result in collisions with catastrophic consequences, such as serious injury or death. Know your limits. Be honest with yourself about your true ability and be certain you have a location where you can safely run the model.

Closed Course Only!

Location is the most important thing to consider when driving 100mph. Only drive the XO-1 at full speed on a closed course where there is no possibility for an animal, spectator or other person to wander into the path of the vehicle. As the owner and driver, you must take every possible precaution to ensure that there is absolutely no chance for the car to collide with another human being, or serious and even fatal injuries could result. Use a dragstrip or race course where there is great visibility, barricades, and pedestrian access control. Always think about what could happen if the car is driven out of control. Are people far enough away from it? Are there barricades to contain it? Can you see far enough to the left and right of your path to see if anyone is approaching? Where will the car go if you drive it out of range?

Never attempt to run the XO-1 at its maximum speed in the presence of children, animals (pets), or on any public thoroughfares where you do not have complete control over access by people and other vehicles. Always drive the car away from you for maximum speed and never drive at maximum speed with the car coming directly towards you.

Choosing a Closed Course For Your Model

The XO-1 requires 1000 feet of smooth, level surface to achieve its peak speed. Do not operate the XO-1 off-road. Walk the complete length of the course to ensure that there is no debris on the surface that could impact the car and cause a potential loss of control. At 100mph, the XO-1 is traveling approximately 150 feet per second. Make sure that there is plenty of room for steering corrections during the run and adequate room to slow and stop at the end of the run.

Driver Skill

The XO-1 is rated Skill Level 10, our highest skill level. This model is for experts only. The XO-1 is not for drivers under the age of 16. Drivers that are 16-18 years old must still be accompanied by a mature and responsible adult to confirm that the XO-1 is being operated safely and that all precautions are being taken. Advanced driving skills are required in order to safely operate the XO-1 at speeds above 50mph. Gradually work up to the top speed to become intimately familiar with the handling and driving characteristics of the car. Inexperienced drivers should simply leave the speed limiters in place until they acquire the skills necessary to reach maximum speed.

Car Inspection

As part of the responsibility of ownership, the XO-1 should be carefully inspected prior to driving at high speeds. Check to make sure that the electronics are in good working order and that the connections are secure. Make sure the radio system range is adequate and without interference in the area where you will be driving. Inspect the tires for proper gluing and damage. Inspect the mechanical and aero components for any damage. Tighten any loose hardware, paying special attention to the wheel nuts.

Wind and Weather

Aerodynamics play an important role in the performance of the XO-1. Choose a day and a location where the wind is calm to prevent crosswinds from interfering with your driving.

Performing a Maximum-Speed Run

Run the car the full length of the course at reduced speed to become familiar with the surface, the car, and the conditions. DO NOT just "go for it". Start with a 50mph pass (or slower) and gradually increase speed. What seems like a gentle dip at 50mph may greatly upset the car at 80mph. When you are ready to attempt maximum speed, apply the throttle slowly to ensure a smooth, straight launch. If steering corrections are necessary, make small inputs. Be careful not to over-control the car. At the end of the run, or anytime during the run if you feel you are not in complete control, apply the brakes gently to avoid locking the tires. If the brakes are locked up, there will not be any steering control. Rolling onto the brakes gently but firmly will slow the car down quickly. Locking the brakes eliminates control and results in greater stopping distances.

Storage

Once your speed control is unlocked, the XO-1 is capable of full speed at any time. Lock the power system whenever the model is stored to prevent unauthorized drivers from attempting 100mph runs. Make sure to store your XO-1 where children and unauthorized drivers cannot access and run the car without your knowledge.

The XO-1's TQi transmitter is equipped with the Traxxas Link™ Wireless Module. This innovative accessory transforms your Apple® iPhone®, iPad®, iPod touch®, or Android™ device into a powerful tuning tool that equips your TQi with an intuitive, high-definition, full-color graphical user interface.

Traxxas Link

The powerful Traxxas Link application (available in the Apple App StoreSM or on Google Play™) gives you complete control over the operation and tuning of your Traxxas model with stunning visuals and absolute precision. With the installed Traxxas Link telemetry sensors on the model, Traxxas Link displays real-time data, such as speed, RPM, temperature, and battery voltage.

Intuitive iPhone, iPad, iPod touch, and Android interface

Traxxas Link makes it easy to learn, understand, and access powerful tuning options. Control Drive Effects settings such as TSM assistance percentage; steering and throttle sensitivity; steering percentage; braking strength; and throttle trim by simply touching and dragging the sliders on the screen.

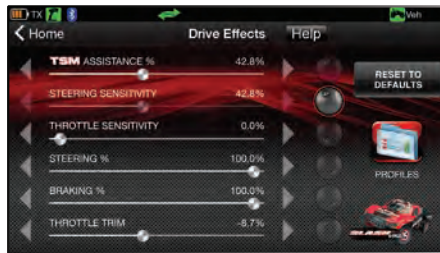

Tap and slide to adjust TSM, Steering Sensitivity, Throttle Trim, Braking Percent, and more!

Real-Time Telemetry

With the installed telemetry sensors, the Traxxas Link dashboard comes to life showing you speed, battery voltage, RPM, and temperature. Set threshold warnings and log maximums, minimums, or averages. Use the recording function to document your dashboard view, with sound, so that you can keep your eyes on your driving and not miss a single apex.



The customizable Traxxas Link dashboard delivers real-time rpm, speed, temperature, and voltage data.

Manage up to 30 Models with Traxxas Link

The TQi radio system automatically keeps track of what vehicles it has bound to and what settings were used for each--up to 30 models total! Traxxas Link provides a visual interface to name the models, customize their settings, attach profiles, and lock them into memory. Simply choose a model and any previously bound transmitter, power them up, and start having fun.

Available Tuning Adjustments

The following items can be adjusted most easily using your mobile device and the Traxxas Link app. All the features described below may also be accessed using the menu and set buttons on the transmitter and observing signals from the LED. An explanation of the menu structure follows on page 34.

Your Traxxas transmitter has a programmable Multi-Function knob that can be set to control various advanced transmitter functions (set to Traxxas Stability Management (TSM) by default, see page 17). Experiment with the settings and features to see if they can improve your driving experience.

Steering Sensitivity (Exponential)

The Multi-Function knob on the TQi transmitter can be set to control Steering Sensitivity (also known as exponential). The standard setting for Steering Sensitivity is "normal (zero exponential)," with the dial full left in its range of travel. This setting provides linear servo response: the steering servo's movement will correspond exactly with the input from the transmitter's steering wheel. Turning the knob clockwise from center will result in "negative exponential" and decrease steering sensitivity by making the servo less responsive near neutral, with increasing sensitivity as the servo nears the limits of its travel range. The farther you turn the knob, the more pronounced the change in steering servo movement will be. The term "exponential" comes from this effect; the servo's travel changes exponentially relative to the input from the steering wheel. The exponential effect is indicated as a percentage—the greater the percentage, the greater the effect. The illustrations below show how this works.

Normal Steering Sensitivity (0% exponential):

In this illustration, the steering servo's travel (and with it, the steering motion of the model's front wheels) corresponds precisely with the steering wheel. The ranges are exaggerated for illustrative purposes.

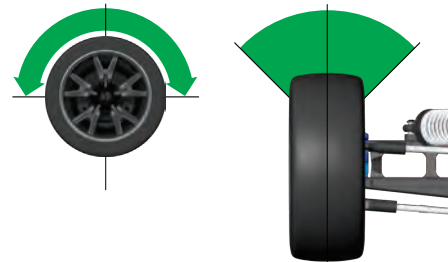

Decreased Steering Sensitivity (Negative Exponential):

By turning the Multi-Function knob clockwise, the steering sensitivity of the model will be decreased. Note that a relatively large amount of steering wheel travel results in a smaller amount of servo travel. The farther you turn the knob, the more pronounced the effect becomes. Decreased steering sensitivity may be helpful when driving on low-traction surfaces, when driving at high speed, or on tracks that favor sweeping turns where gentle steering inputs are required. The ranges are exaggerated for illustrative purposes.

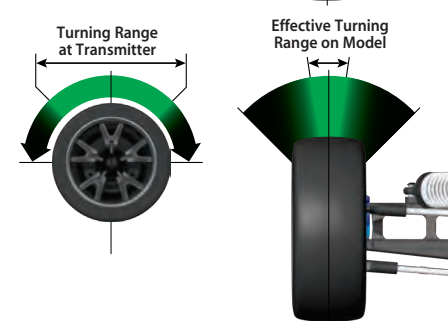



Throttle Trim Seek Mode

When the Multi-Function knob is set to throttle trim, the transmitter remembers the throttle trim setting. If the throttle trim knob is moved from the original setting while the transmitter is off, or while the transmitter was used to control another model, the transmitter ignores the actual position of the trim knob. This prevents the model from accidentally running away. The LED on the face of the transmitter will rapidly blink green and the throttle trim knob (Multi-Function knob) will not adjust the trim until it is moved back to its original position saved in memory. To restore throttle trim control, simply turn the Multi-Function knob either direction until the LED stops blinking.



Failsafe

Your Traxxas radio system is equipped with a built-in failsafe function that returns the throttle to its last saved neutral position in the event of a signal loss. The LED on the transmitter and the receiver will rapidly flash red.

Throttle Sensitivity (Throttle Exponential)

The Multi-Function knob can be set to control Throttle Sensitivity. Throttle Sensitivity works the same way as Steering Sensitivity, but applies the effect to the throttle channel. Only forward throttle is affected; brake/reverse travel remains linear regardless of the Throttle Sensitivity setting.

Steering Percentage (Dual Rate)

The Multi-Function knob can be set to control the amount (percentage) of servo travel applied to steering. Turning the Multi-Function knob fully clockwise will deliver maximum steering throw; turning the knob counter-clockwise reduces steering throw (**Note:** Turning the dial counter-clockwise to its stop will eliminate all servo travel). Be aware that the steering End Point settings define the servo's maximum steering throw. If you set Steering Percentage to 100% (by turning the Multi-Function knob fully clockwise), the servo will travel all the way to its selected end point, but not past it. Many racers set Dual Rate so they have only as much steering throw as they need for the track's tightest turn, thus making the car easier to drive throughout the rest of the course. Reducing steering throw can also be useful in making a car easier to control on high-traction surfaces, and limiting steering output for oval racing where large amounts of steering travel are not required.

Braking Percentage

The Multi-Function knob may also be set to control the amount of brake travel applied by the servo in a nitro-powered model. Electric models do not have a servo-operated brake, but the Braking Percentage function still operates the same way in electric models. Turning the Multi-Function knob full clockwise will deliver maximum brake throw; turning the knob counter-clockwise reduces brake throw (**Note:** Turning the dial counter-clockwise to its stop will eliminate all brake action).

Throttle Trim

Setting the Multi-Function knob to serve as throttle trim will allow you to adjust the throttle's neutral position to prevent unwanted brake drag or throttle application when the transmitter trigger is at neutral. **Note:** Your transmitter is equipped with a Throttle Trim Seek mode to prevent accidental runaways. See the sidebar for more information.

TRAXXAS LINK MODULE LED CODES

LED Color / Pattern	Name	Notes
Blue LED off	Connecting mode	Traxxas Link App is not running on a paired device.
Slow blue (0.5 sec on / 0.5 sec off)	Pairing mode	See page 29 for information on pairing the module with Traxxas Link App.
Solid blue	Connected	See page 15 for information on how to use your transmitter controls.

TRANSMITTER LED CODES

LED Color / Pattern	Name	Notes
Solid green	Normal Driving Mode	See page 15 for information on how to use your transmitter controls.
Slow red (0.5 sec on / 0.5 sec off)	Binding	See page 16 for more information on binding.
Flashing fast green (0.1 sec on / 0.15 sec off)	Throttle Trim Seek Mode	Turn the Multi-Function knob right or left until the LED stops flashing. See sidebar for more information.
Flashing medium red (0.25 sec on / 0.25 sec off)	Low Battery Alarm	Put new batteries in the transmitter. See page 13 for more information.
Flashing fast red (0.125 sec on / 0.125 sec off)	Link Failure / Error	Transmitter and receiver are no longer bound. Turn the system off and then back on to resume normal operation. Find source of the link failure (ie out of range, low batteries, damaged antenna).
Programming Patterns		
Counts out number (green or red) then pauses	Current menu position	See Menu Tree for more information.
x8 Fast green 8 times	Menu setting accepted (on SET)	
x8 Fast red 8 times	Menu SET invalid	User error such as trying to delete a locked model.

RECEIVER LED CODES

LED Color / Pattern	Name	Notes
Solid green	Normal Driving Mode	See page 15 for information on how to use your transmitter controls.
Slow red (0.5 sec on / 0.5 sec off)	Binding	See page 16 for more information on binding.
Flashing fast red (0.125 sec on / 0.125 sec off)	Fail-Safe / Low-Voltage Detect	Consistent Low-Voltage in the receiver triggers Fail-Safe so there is enough power to center the throttle servo before it completely loses power.

Steering and Throttle End Points

The TQi transmitter allows you to choose the limit of the servo's travel range (or its "end point") independently for left and right travel (on the steering channel) and throttle/brake travel (on the throttle channel). This allows you to fine-tune the servo settings to prevent binding caused by the servo moving steering or throttle linkages (in the case of a nitro car) farther than their mechanical limits. The end point adjustment settings you select will represent what you wish to be the servo's maximum travel; the Steering Percentage or Braking Percentage functions will not override the End Point settings.

Steering and Throttle Sub-Trim

The Sub-Trim function is used to precisely set the neutral point of the steering or throttle servo in the event that simply setting the trim knob to "zero" does not completely center the servo. When selected, Sub-Trim allows finer adjustment to the servo output shaft's position for precise setting of the neutral point. Always set the Steering Trim knob to zero before making final adjustment (if required) using Sub-Trim. If Throttle Trim has been previously adjusted, the Throttle Trim will need to be reprogrammed to "zero" before making final adjustment using Sub-Trim.

Setting Lock

Once you've adjusted all of these settings the way you like them, you may want to disable the Multi-Function knob so none of your settings can be changed. This is especially handy if you operate multiple vehicles with a single transmitter via Traxxas Link Model Memory.

Multiple Settings and the Multi-Function Knob

It is important to note that settings made with the Multi-Function knob are "overlaid" on top of each other. For example, if you assign the Multi-Function to adjust Steering Percentage and set it for 50%, then reassign the knob to control Steering Sensitivity, the transmitter will "remember" the Steering Percentage setting. Adjustments you make to Steering Sensitivity will be applied to the 50% steering throw setting you selected previously. Likewise, setting the Multi-Function knob to "disabled" will prevent the knob from making further adjustments, but the last setting of the Multi-Function knob will still apply.

TRAXXAS LINK MODEL MEMORY

Traxxas Link Model Memory is an exclusive, patent-pending feature of the TQi transmitter. Each time the transmitter is bound to a new receiver, it saves that receiver in its memory along with all the settings assigned to that receiver. When the transmitter and any bound receiver are switched on, the transmitter automatically recalls the settings for that receiver. There is no need to manually select your vehicle from a list of model memory entries.

Model Lock

The Traxxas Link Model Memory feature can store up to thirty models (receivers) in its memory. If you bind a thirty-first receiver, Traxxas Link Model Memory will delete the "oldest" receiver from its memory (in other words, the model you used the longest time ago will be deleted). Activating Model Lock will lock the receiver in memory so it cannot be deleted.

You may also bind multiple TQi transmitters to the same model making it possible to pick up any transmitter and any previously bound model in your collection and simply turn them on and drive. With Traxxas Link Model Memory, there is no need remember which transmitter goes with which model and there is never a need to have to select any model from a list of model memory entries. The transmitter and receiver do it all for you automatically.

To activate Model Lock:

1. Switch on the transmitter and receiver you wish to lock.
2. Press and hold MENU. Release when the status LED blinks green.
3. Press MENU three times. The status LED will blink green four times repeatedly.
4. Press SET. The status LED will blink green in single-flash intervals.
5. Press SET once. The status LED will blink red once repeatedly.
6. Press MENU once, the LED will blink red twice repeatedly.
7. Press SET, the LED will blink rapidly green. The memory is now locked. Press MENU and SET to return to driving mode.

Note: To unlock a memory, press SET twice at step 5. The LED will blink rapidly green to indicate the model is unlocked. To unlock all models, press MENU twice at step 6 and then press SET.

To delete a model:

At some point, you may wish to delete a model you no-longer drive from the memory.

1. Switch on the transmitter and receiver you wish to delete.
2. Press and hold MENU. Release when the status LED blinks green.
3. Press MENU three times. The status LED will blink green four times repeatedly.
4. Press SET once. The status LED will blink green once repeatedly.
5. Press MENU once. The status LED will blink green twice repeatedly.
6. Press SET. The memory is now selected to be deleted. Press SET to delete the model. Press and hold MENU to return to driving mode.



Starting Over: Restoring Factory Defaults

When programming your 2.4GHz transmitter, you may feel the need to start over with a clean slate. Follow these simple steps to restore the factory settings:

1. Turn transmitter off.
2. Hold both MENU and SET.
3. Turn transmitter on.
4. Release MENU and SET. The transmitter LED will blink red.
5. Press MENU once. The transmitter LED will blink red twice repeatedly.
6. Press SET to clear settings. The LED will turn solid green and the transmitter is restored to default.

MENU TREE

The Menu Tree below shows how to navigate through the TQi transmitter's various settings and functions. Press and hold MENU to enter the Menu Tree, and use the following commands to navigate through the menu and select options.

MENU: When you enter a menu, you always start at the top. Press MENU to move down the Menu Tree. When you reach the bottom of the tree, pressing MENU again will return you to the top.

SET: Press SET to move across the Menu Tree and select options. When an option is committed to the transmitter's memory, the status LED will rapidly blink green.

BACK: Press both MENU and SET to go back one level in the Menu Tree.

EXIT: Press and hold MENU to exit programming. Your selected options will be saved.

ECHO: Press and hold SET to activate the "echo" function. Echo will "play back" your current position on the Menu Tree should you lose your place. For example: If your current position is Steering Channel End Points, holding SET will cause the LED to blink green twice, green once, and then red three times. Echo will not alter your adjustments or change your position in the programming sequence.

Below is an example of how to access a function in the Menu Tree. In the example, the user is setting the Multi-Function knob to be a Steering % (Dual-Rate) control.

- To set the Multi-Function knob to control STEERING % (DUAL-RATE):
1. Switch the transmitter on.
 2. Press and hold MENU until the green LED lights. It will blink in single intervals.
 3. Press SET. The red LED will blink in single intervals to indicate Steering Sensitivity (Expo) has been selected.
 4. Press MENU twice. The red LED will blink three times repeatedly to indicate Steering % (Dual-Rate) has been selected.
 5. Press SET to select. The green LED will blink 8 times fast to indicate successful selection.
 6. Press and hold MENU to return to driving mode.

Restoring Factory Defaults:

Transmitter OFF	Hold both MENU and SET	Transmitter ON	Release MENU and SET red LED blinks	Press SET to clear settings. LED will turn solid green. Transmitter is restored to default
-----------------	------------------------	----------------	--	--

*Torque Control is a feature designed only for use with the power system in the Traxxas Funny Car Race Replica (Model #6907).

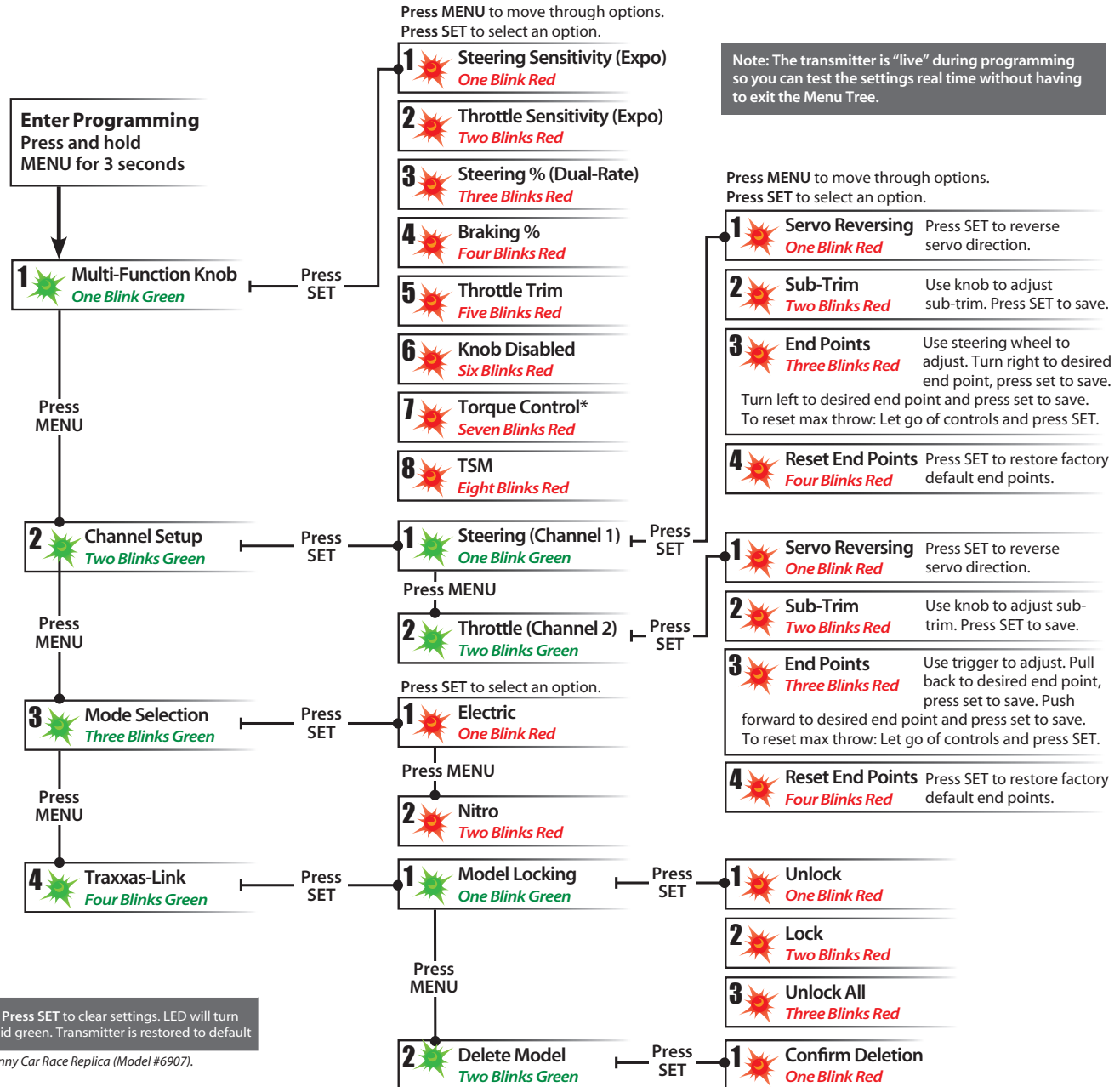

Note: The transmitter is "live" during programming so you can test the settings real time without having to exit the Menu Tree.

Set Multi-Function knob for STEERING SENSITIVITY (Expo)	Press/hold MENU green LED blinks	Press SET red LED blinks	Press SET to confirm green LED blinks (x8)	Press/hold MENU returns to driving mode						
Set Multi-Function knob for THROTTLE SENSITIVITY (Expo)	Press/hold MENU green LED blinks	Press SET red LED blinks	Press MENU to confirm red LED blinks (x2)	Press SET to select green LED blinks (x8)	Press/hold MENU returns to driving mode					
Set Multi-Function knob for STEERING DUAL RATE (%)	Press/hold MENU green LED blinks	Press SET red LED blinks	Press MENU twice red LED blinks (x3)	Press SET to select green LED blinks (x8)	Press/hold MENU returns to driving mode					
Set Multi-Function knob for BRAKING PERCENTAGE (%)	Press/hold MENU green LED blinks	Press SET red LED blinks	Press MENU 3 times red LED blinks (x4)	Press SET to select green LED blinks (x8)	Press/hold MENU returns to driving mode					
Set Multi-Function knob for THROTTLE TRIM	Press/hold MENU green LED blinks	Press SET red LED blinks	Press MENU 4 times red LED blinks (x5)	Press SET to select green LED blinks (x8)	Press/hold MENU returns to driving mode	Adjust the Multi-Function knob until the LED turns solid green.				
To LOCK the Multi-Function knob	Press/hold MENU green LED blinks	Press SET red LED blinks	Press MENU 5 times red LED blinks (x6)	Press SET to lock green LED blinks (x8)	Press/hold MENU returns to driving mode					
To REVERSE the direction of STEERING servo	Press/hold MENU green LED blinks	Press MENU green LED blinks (x2)	Press SET green LED blinks	Press SET red LED blinks	Press SET to reverse servo direction	Press/hold MENU returns to driving mode				
To set the SUB TRIM of the STEERING servo	Press/hold MENU green LED blinks	Press MENU green LED blinks (x2)	Press SET green LED blinks	Press SET red LED blinks	Press MENU red LED blinks (x2)	Use Multi-Function knob to set neutral	Press SET to save position	Press/hold MENU returns to driving mode		
To set the END POINTS of the STEERING servo	Press/hold MENU green LED blinks	Press MENU green LED blinks (x2)	Press SET green LED blinks	Press SET red LED blinks	Press MENU twice red LED blinks (x3)	Turn steering wheel to desired max left and right travel	Press SET to save each position	Turn steering wheel to test settings	IF END POINTS ARE OK: Press/hold MENU returns to driving mode	IF END POINTS NEED TO BE CHANGED: Press SET and repeat steps 6-8
To reset the END POINTS of STEERING servo to defaults	Press/hold MENU green LED blinks	Press MENU green LED blinks (x2)	Press SET green LED blinks	Press SET red LED blinks	Press MENU 3 times red LED blinks (x4)	Press SET to reset end points	Press/hold MENU returns to driving mode			
To REVERSE the direction of THROTTLE servo	Press/hold MENU green LED blinks	Press MENU green LED blinks (x2)	Press SET green LED blinks	Press MENU green LED blinks (x2)	Press SET red LED blinks	Press SET to reverse servo direction	Press/hold MENU returns to driving mode			
To set the SUB TRIM of the THROTTLE servo	Press/hold MENU green LED blinks	Press MENU green LED blinks (x2)	Press SET green LED blinks	Press MENU green LED blinks (x2)	Press SET red LED blinks	Press MENU red LED blinks (x2)	Use Multi-Function knob to set neutral	Press SET to save position	Press/hold MENU returns to driving mode	
To set the END POINTS of the THROTTLE servo	Press/hold MENU green LED blinks	Press MENU green LED blinks (x2)	Press SET green LED blinks	Press MENU green LED blinks (x2)	Press SET red LED blinks	Press MENU twice red LED blinks (x3)	Use throttle trigger to set desired max throttle or brake	Press SET to save Use trigger to test	IF END POINTS ARE OK: Press/hold MENU returns to driving mode	IF END POINTS NEED TO BE CHANGED: Press SET and repeat steps 7-9
To reset the END POINTS of THROTTLE servo to defaults	Press/hold MENU green LED blinks	Press MENU green LED blinks (x2)	Press SET green LED blinks	Press MENU green LED blinks (x2)	Press SET red LED blinks	Press MENU 3 times red LED blinks (x4)	Press SET to save position	Press/hold MENU returns to driving mode		

MENU TREE FORMULAS

To select functions and make adjustments to the TQi transmitter without referencing the menu tree, turn your transmitter on, find the function in the left column you wish to adjust, and simply follow the corresponding steps.



XO-1

MODEL 64077-3

TRAXXAS

OWNER'S MANUAL

6250 TRAXXAS WAY, MCKINNEY, TEXAS 75070

1-888-TRAXXAS