

HEXBUG®

VEX®
ROBOTICS



EXCAVATOR™

PARENT/GUARDIAN • PARENT/TUTEUR • PADRE/GUARDIÁN • RODZIC/OPIEKUN • VANHEMPI /HUOLTAJA • FÖRÄLDER / MÅLSMAN

Part Size • Taille de la pièce • Tamaño de la pieza •
Teilegröße • Dimensione parte • Wielkość części •
Osan koko • Delstorlek • Delstorrelse • Del Storrelse

Quantity • Quantité •
Cantidad • Menge •
Quantità • Ilość •
Määrä • Mängd •
Antall • Antal

1x

228-4133-004

1x5

Part Number • Numéro de pièce •
Número de la pieza • Teilenummer •
Numero di parte • Numer części •
Osanumero • Artikelnummer •
Delnummer • Del Nummer

Part View • Vue de la pièce •
Vista de la pieza • Teilansicht •
Vista parte • Widok części •
Ostittainen näkymä • Del bild •
Delvisning • Delvisning

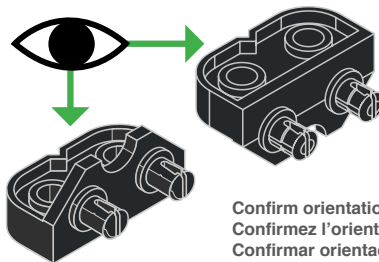

Confirm orientation
Confirmez l'orientation
Confirmar orientación
Ausrichtung prüfen
Confermare l'orientamento
Potwierdź orientację
Vahvista suunta
Bekräfta riktning
Bekräft retning
Sorg for, at de vender rigtigt

Alert Alerte Alerta Warnung Attenzione Ostrzeżenie Varoitus Varning Varsle Alarm	Correct Correcte Correcto Wahrung Attenzione Ostrzeżenie Varoitus Varning Varsle Alarm	Incorrect Incorrecte Incorrecto Falsch Non corretto Nieprawidłowo Väärä Fel Feil Forkert	Flip Retourner Voltear Umdrehen Capovolgere Przerzuc Käännä Vänd Vend Flip	Rotate Faire tourner Girar Drehen Ruotare Obróć Pyörittä Roter Roter Drej	Wind up Liquider Dar cuerda Aufziehen Nawiąć Kierrä Drag upp Trek opp Træk op	Notice Avis Aviso Hinweis Fare attenzione Zwróć uwagę Huomaa OBS Merknad Bemærk

Sticker Autocollant Calcomania Aufkleber Eličekta Naklejka Tarra Klistermärke Klistremerke Klistermærke	Zoom view Zoom Vista con zoom Zoom-Ansicht Vista con zoom Powiększenie Suurennettu näkymä Zoom vy Zoom-visning Zoom visning	Alternate view Autre vue Vista alternativa Andere ansicht Vista alternativa Widok alternatywny Vaihtoehtoinen näkymä Alternativ vy Alternativ visning Alternativ vinkel	Connectors Connecteurs Conectores Anschlüsse Connettori Złącza Liittimet Anslutningar Kontaktpunkter Stik	Electrical Électrique Eléctrico Elektrik Elettrico Elektryczne Sähköinen Elektrisk Elektrisk	Motion Déplacement Movimiento Bewegung Movimento Ruch Liike Rörelse Bevegelse Bevegelse	Structure Structure Estructura Struktur Struttura Konstrukcja Rakenne Struktur Struktur Bygning

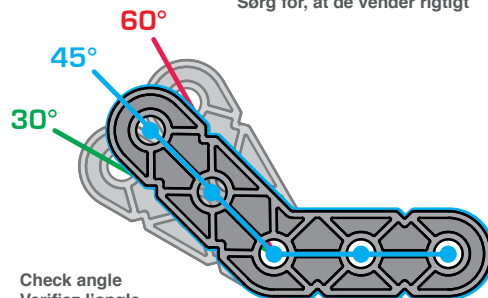

Check angle
Verifiez l'angle
Verificación de ángulo
Winkel prüfen
Controllare l'angolazione
Sprawdź kąt
Tarkista kulma
Kontrollera vinkel
Sjekk vinkel
Tjek vinklen

• ELTERN/ ERZIEHUNGSBERECHTIGTE • GENITORE/TUTORE
• VOKSEN/ VERGE • FORÆLDER/VÆRGE

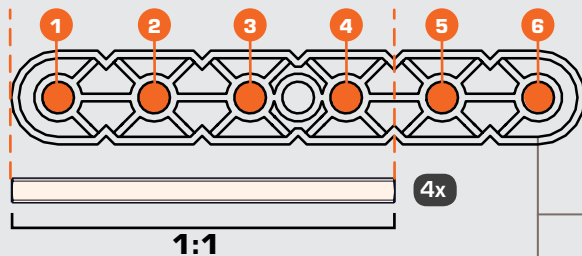

1x6

Count before you connect
Compter avant de connecter
Contar antes de conectar
Erst zählen, dann verbinden
Contare i pezzi prima di collegarli
Policz, zanim połączysz
Laske ennen kuin yhdistät
Räkna innan du sätter ihop
Tell før du kobler til
Tæl, før du samler

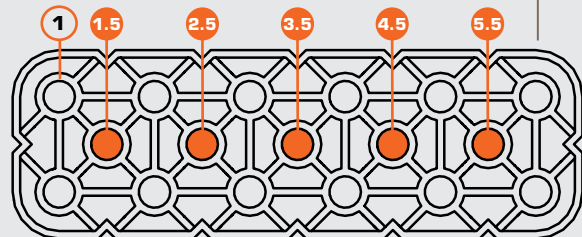

2x6

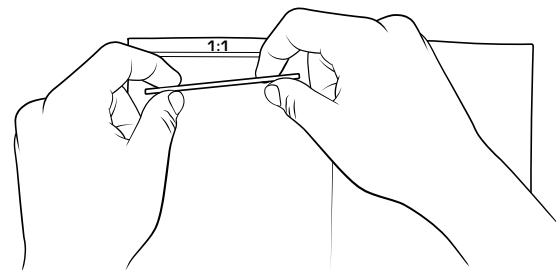

1:1

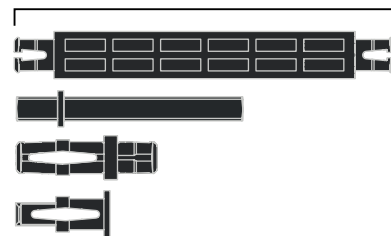

Check pieces against actual size in manual
Vérifiez les pièces contre leurs tailles réelles dans le manuel
Verificar partes contra tamaño real en el manual
Bauteile mit der originalgröße in der anleitung vergleichen
Controllare le dimensioni dei pezzi nel manuale rispetto alla grandezza naturale
Sprawdź elementy względem rzeczywistego rozmiaru w instrukcji
Tarkista kappaleiden todellinen koko vertaamalla ohjekirjaan
Kontrollera bitarnas storlek mot storleken i handboken
Sjekk delene mot faktisk størrelse i manualen
Tjek, om brikkerne passer med den rigtige størrelse i manualen

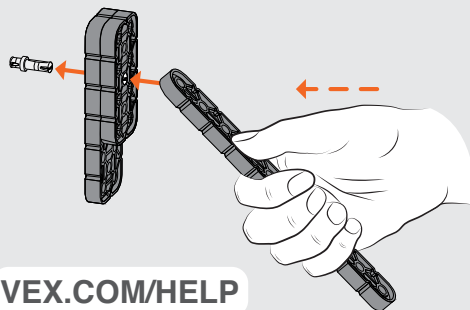

Remove connectors
Retirez connecteurs
Retirar conectores
Verbindungsstücke entfernen
Rimuovere i connettori
Wymij łączniki
Poista liittimet
Ta bort kopplingar
Fjern kontaktpunkter
Fjern koblingsdelene

VEX.COM/HELP

PARTS/ LES PIÈCES/ PARTES/ BAUTEILE/ PARTI/ CZESCI/ OSAT/ DELAR / DELER/ BYGGEDELE



3x

1x5

228-3449-004

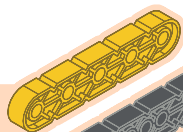

3x

1x6

228-3616-005

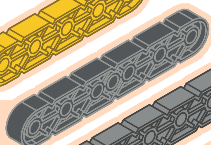

2x

1x7

228-3944-006

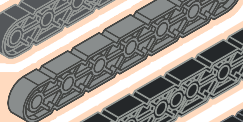

1x

1x8

228-3201-007

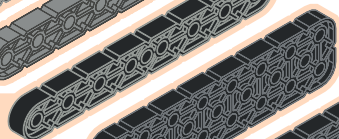

3x

2x8

228-3201-023

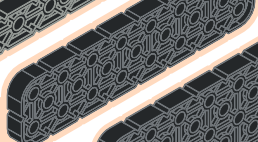

1x

3x8

228-3201-035

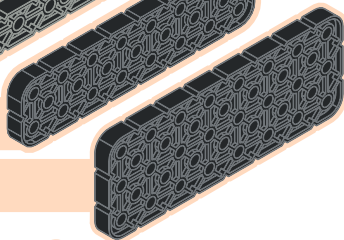

1x

228-3449-511

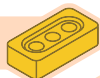

2x

228-3616-1601

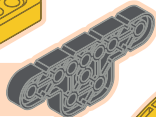

2x

228-3449-2108

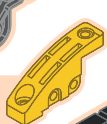

4x

228-3449-2109



1x

4x10

228-3201-044

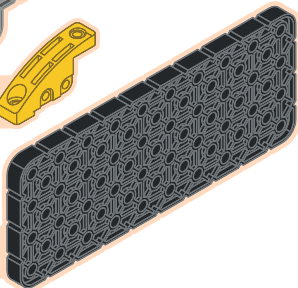

2x

2x3

228-3201-018

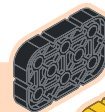

1x

2x4

228-3449-019

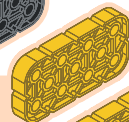

3x

2x6

228-3449-021

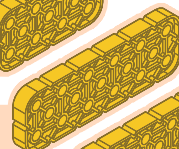

1x

3x6

228-3449-034

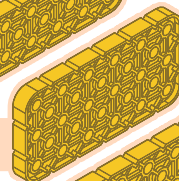

2x

228-3944-1909



1x

4x6

228-3449-042

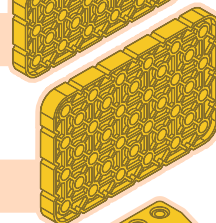

2x

228-3449-1705



10x

1x3

228-3449-002

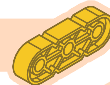

4x

228-2500-143



1x

4x8

228-3201-043

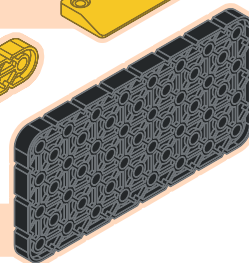

2x **3x3 30°**
228-3201-147

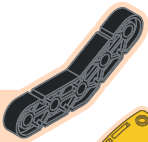

1x 228-3449-2135



8x 228-3944-154



4x **1x2**
228-3201-001



2x **4x12**
228-3201-045

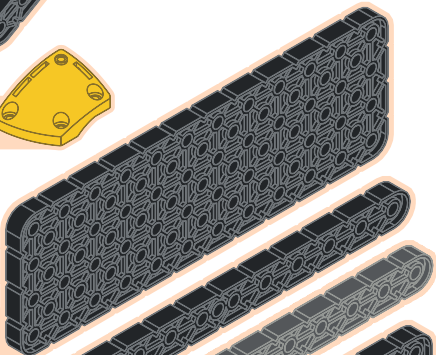

2x **1x12**
228-3201-011

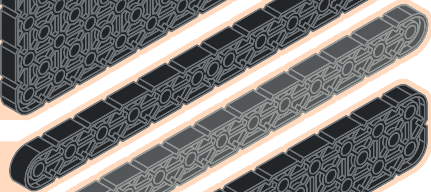

4x **1x13**
228-3616-012

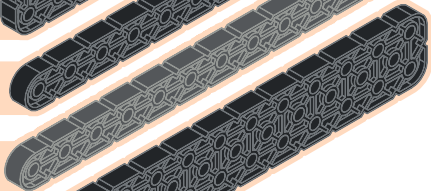

4x **2x12**
228-3201-026



1x 228-3449-2134

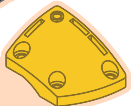

1x **3x5**
228-3201-150



1x 228-3944-1858

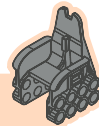

1x **4x4**
228-3616-040

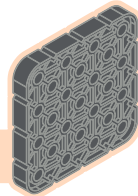

1x 228-3449-520

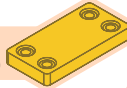

2x 228-3449-2101

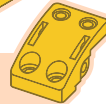

1x **2x3**
228-3201-145



2x **3x3 45°**
228-3449-148

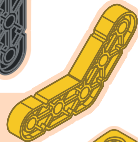

1x 228-3449-2100

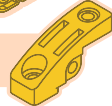

2x **2x2**
228-3201-017



5x **1x4**
228-3616-003

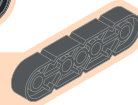

1x 228-3201-2029

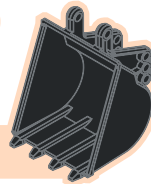

PARTS/ LES PIÉCES/ PARTES/ BAUTEILE/ PARTI/ CZESCI/ OSAT/ DELAR / DELER/ BYGGEDELE

3x

228-3201-175



1x

228-3201-1253

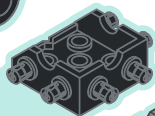

2x

228-3944-1254

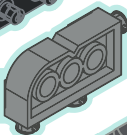

8x

228-3616-170



2x

228-3944-127

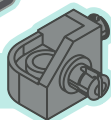

4x

228-3201-109



6x

228-3201-172



4x

228-3201-128

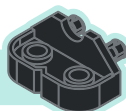

2x

228-3201-129



1x

228-3944-1251

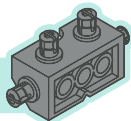

159x

1x1
228-3616-060



9x

1x2
228-3944-061

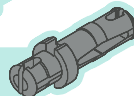

10x

2x2
228-3616-062

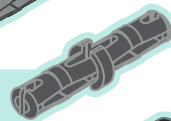

8x

0.25x
228-3201-063

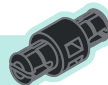

10x

0.5x
228-3944-064

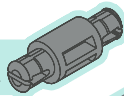

15x

2x
228-3201-067

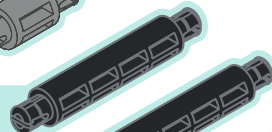

2x

3x
228-3201-069

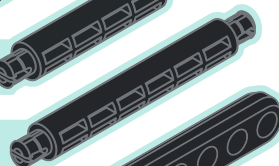

1x

1x4
228-3201-1548

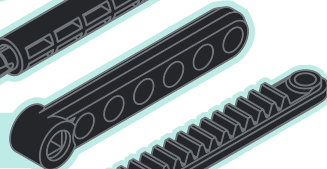

2x

1x6
228-3201-1472

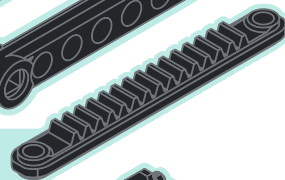

4x

228-3201-126



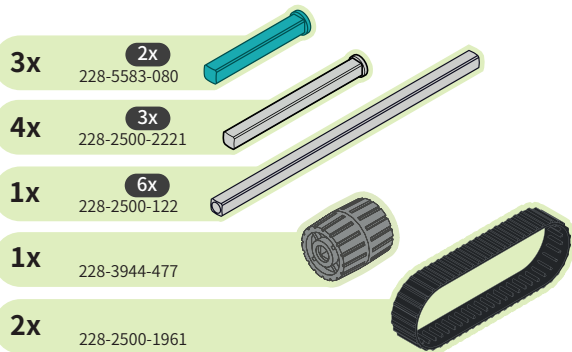
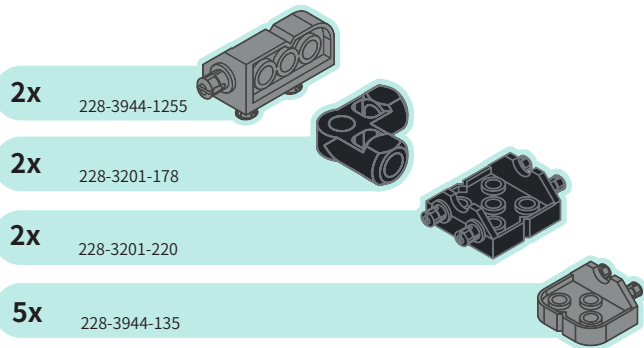

2x8



x3

4x8

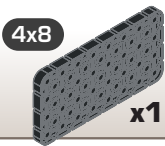

x1

1x1

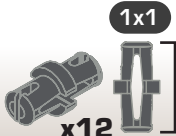

x12

1:1

2x3

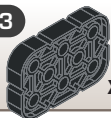

x2

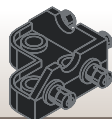

x4

1



2

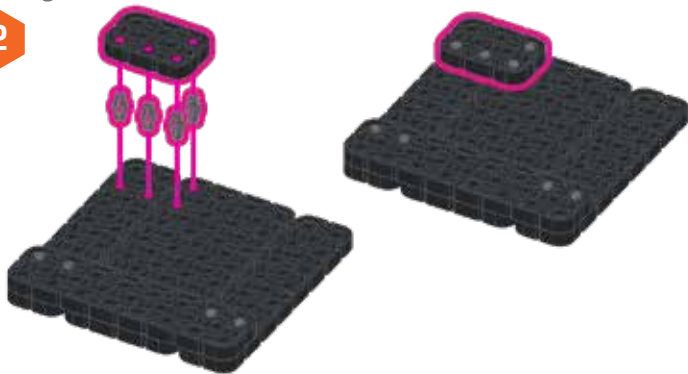

3

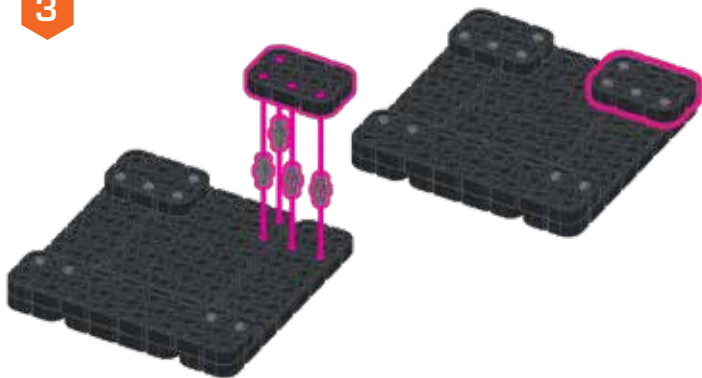

4

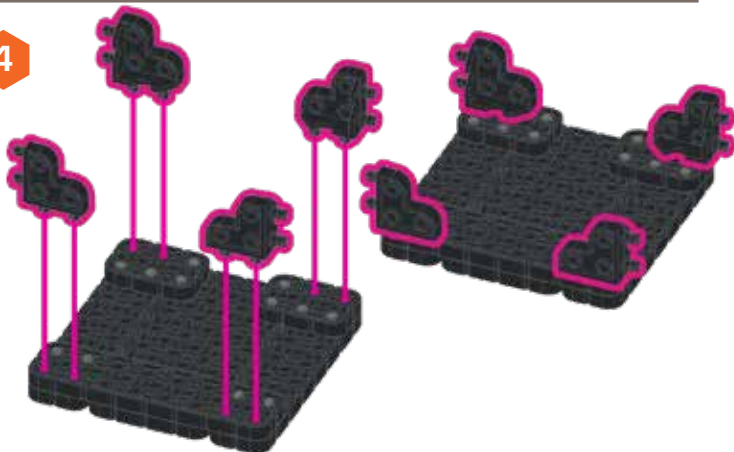

12t x2



2x x3



36t x1

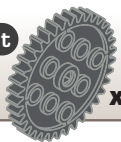

x1



12t x2



3x8 x1

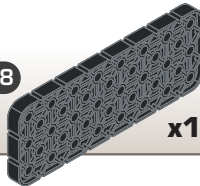

5

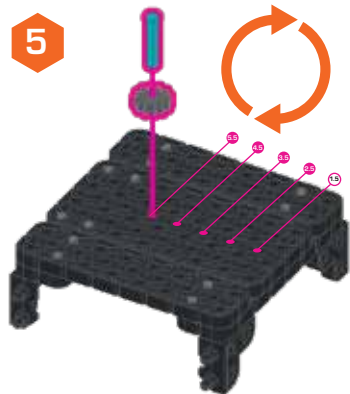

6

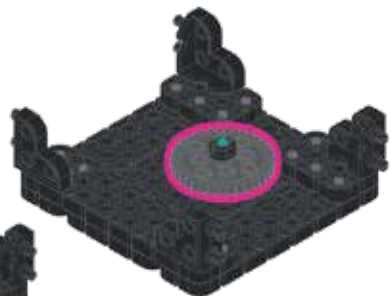
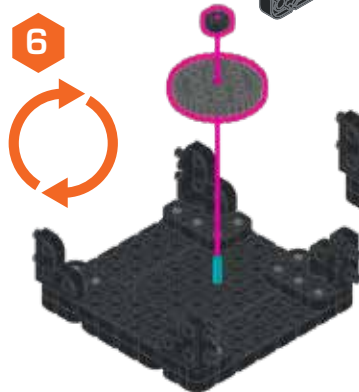

7

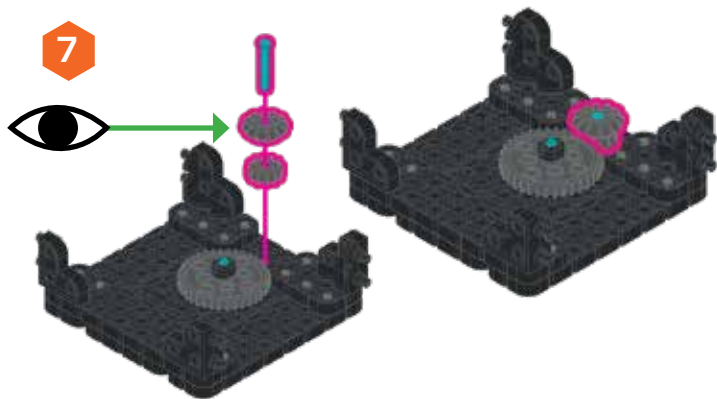

8

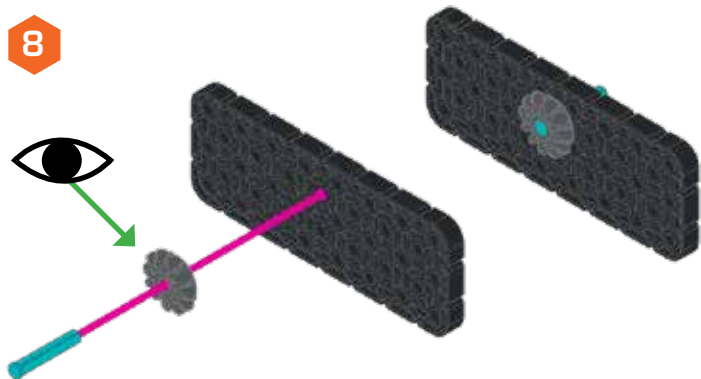

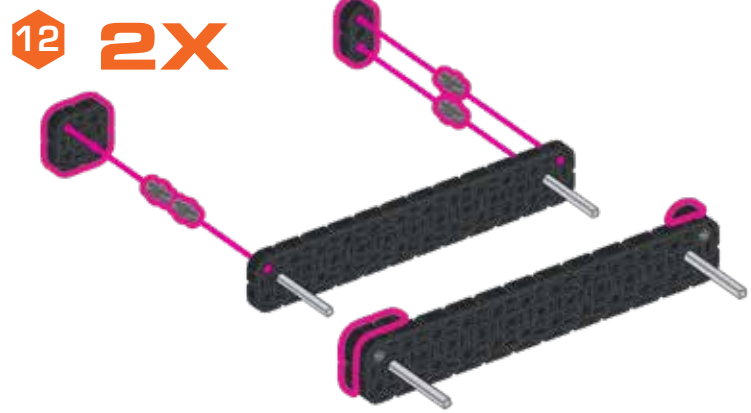
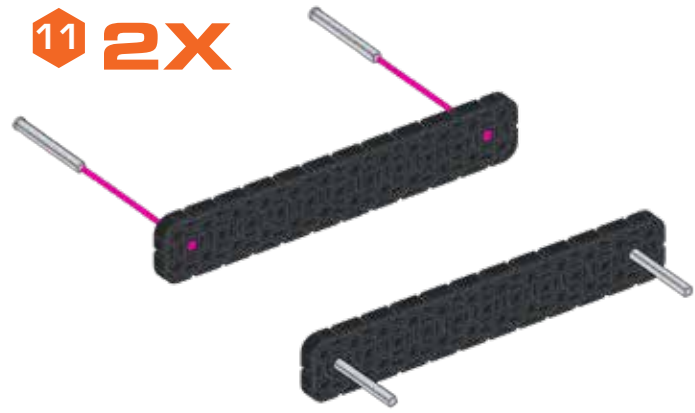
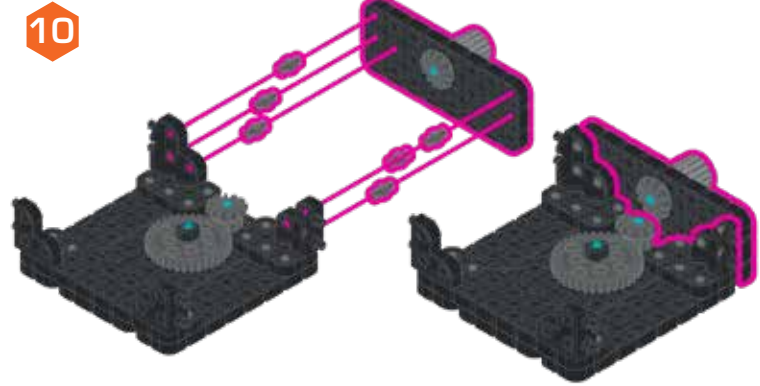
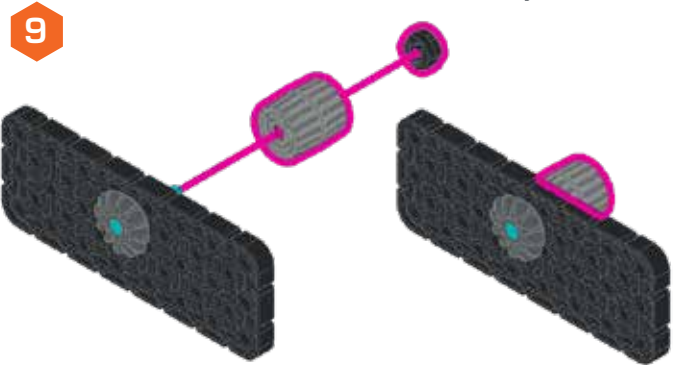
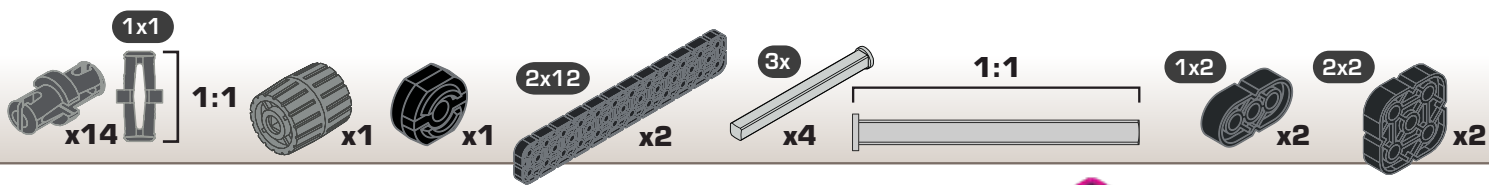

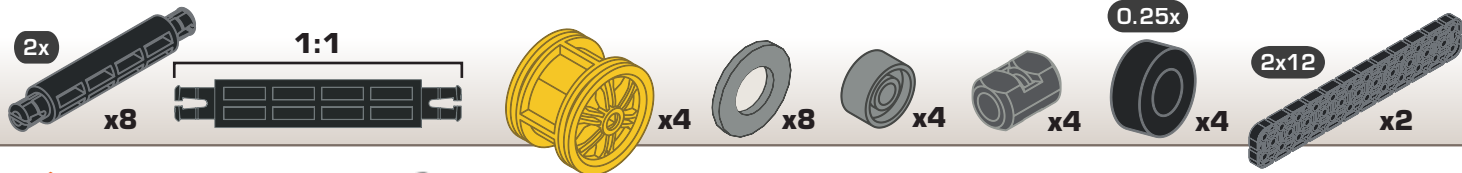

13 2X



14 2X

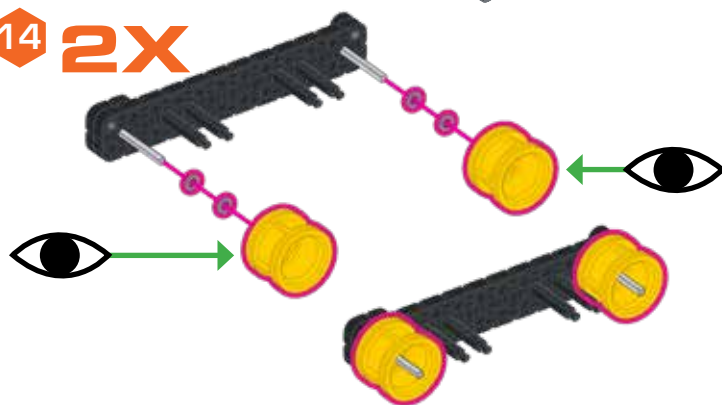

15 2X

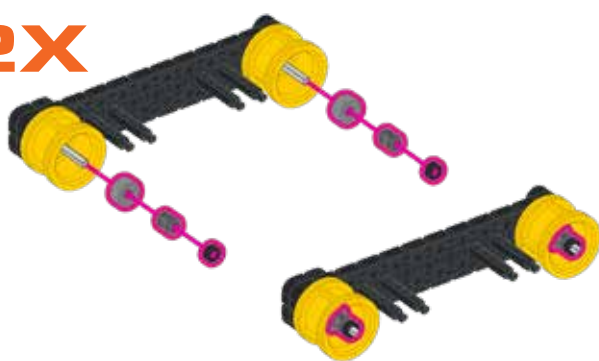

16 2X





x2



x2



x1



x8

1x1



1:1

17

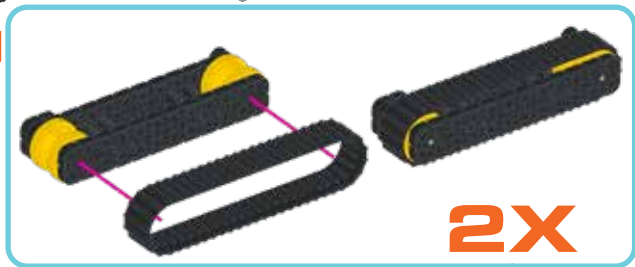

2X

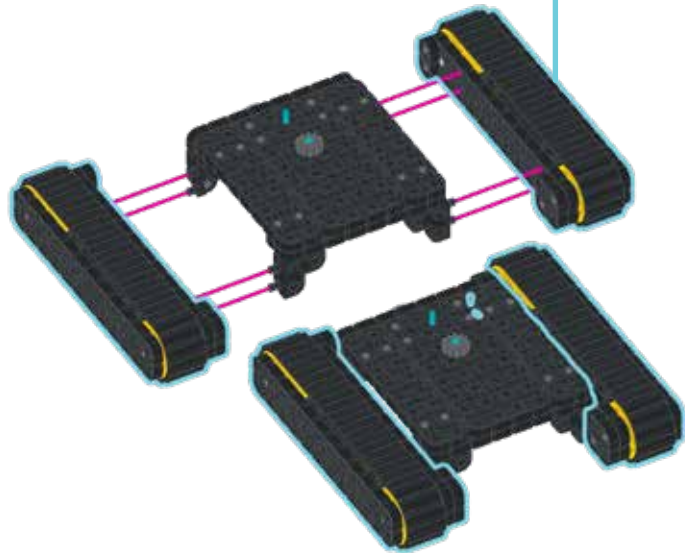

18

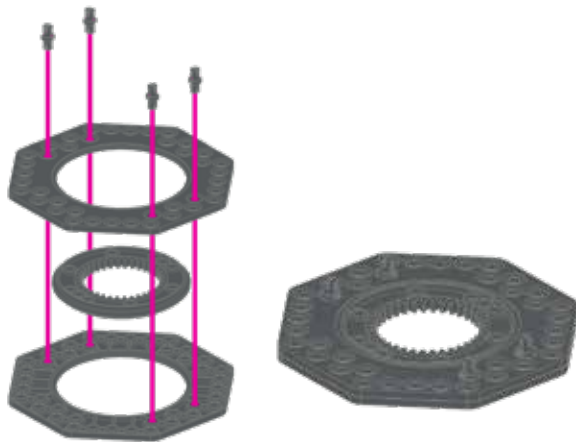

19

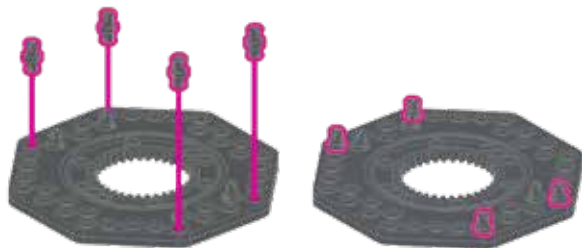

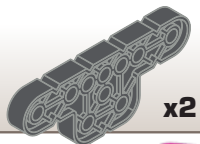

x2



x4



1x1

1:1

20

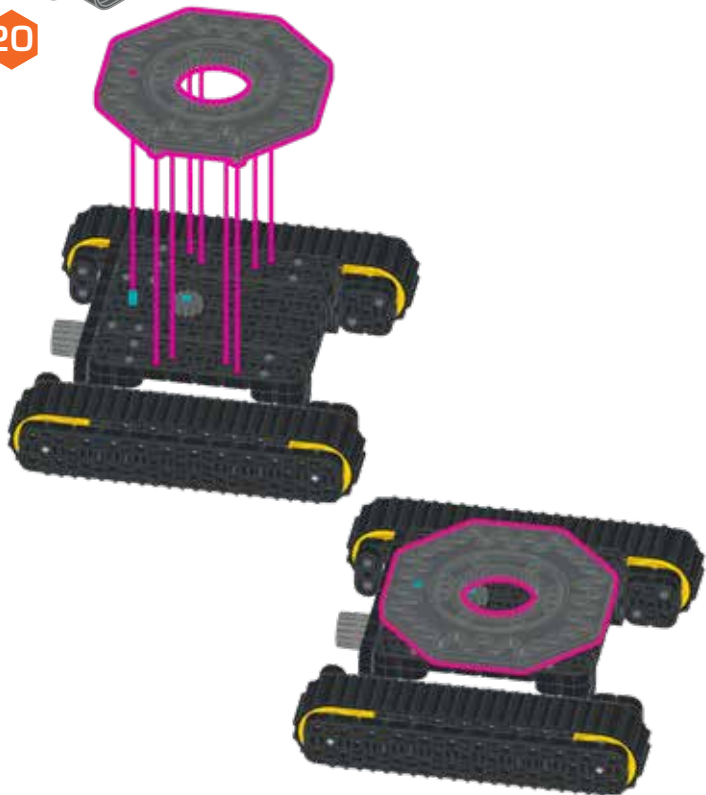

21

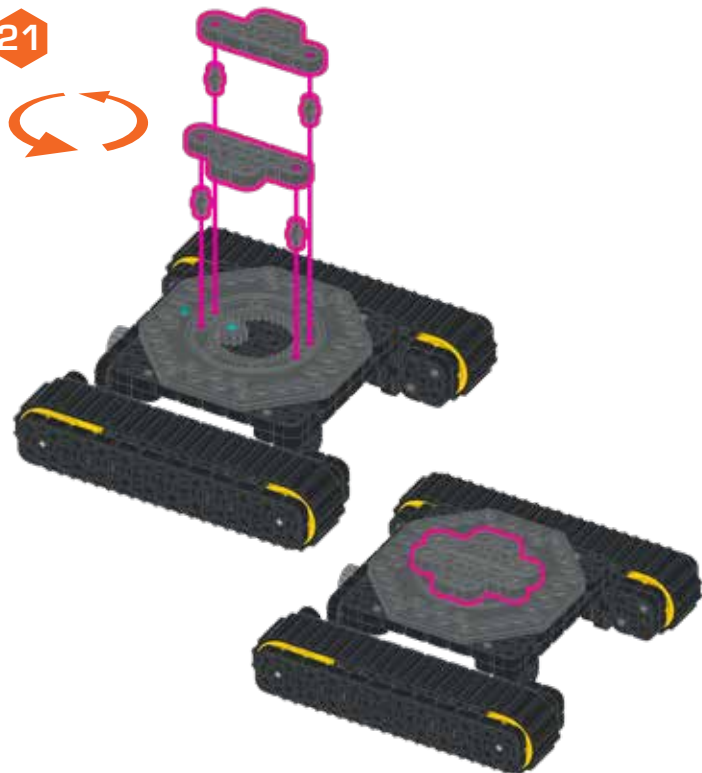

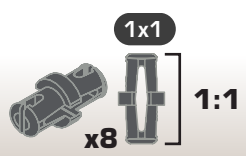

22



23



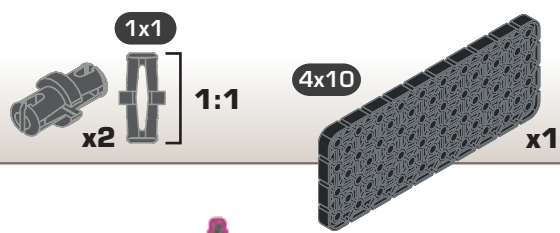

24



25



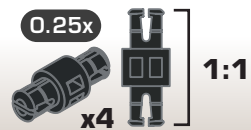
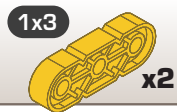
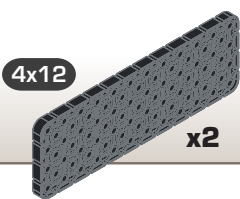
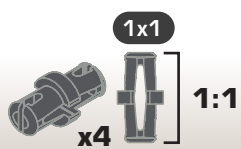

26



27

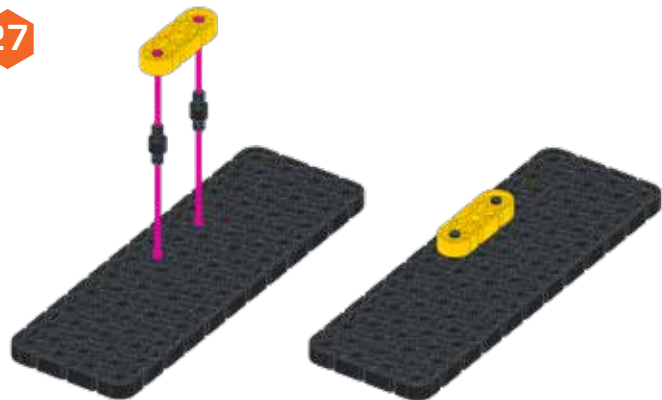

28

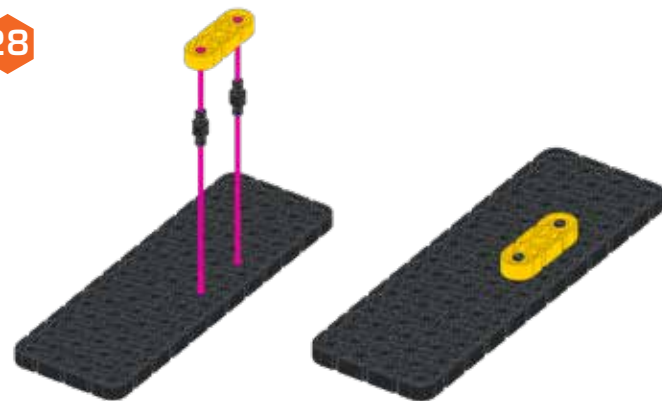

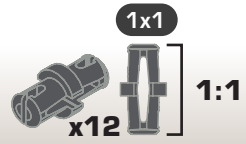
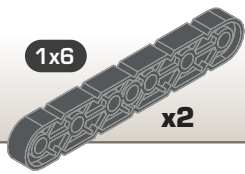

29

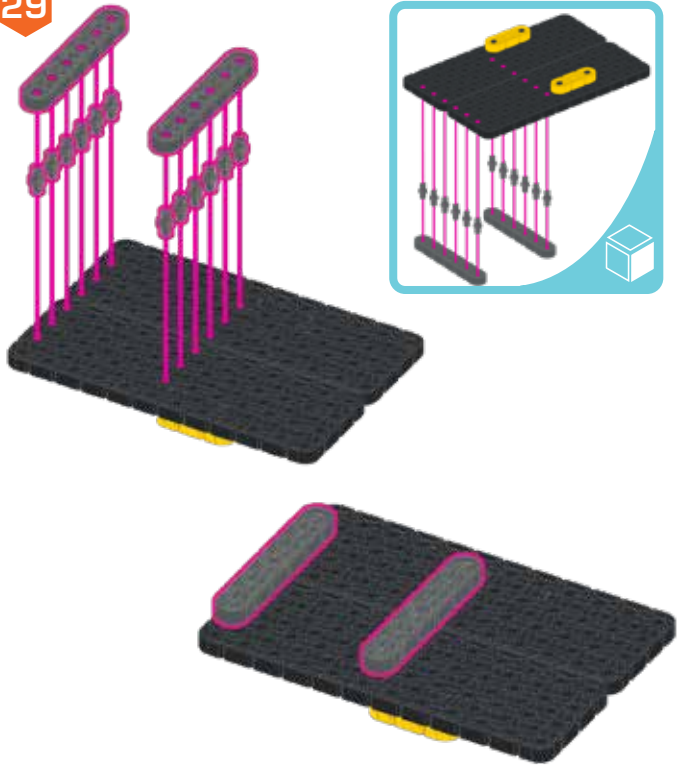

30



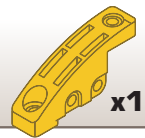
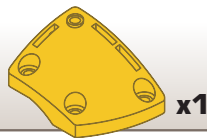
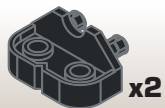
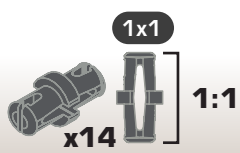

31

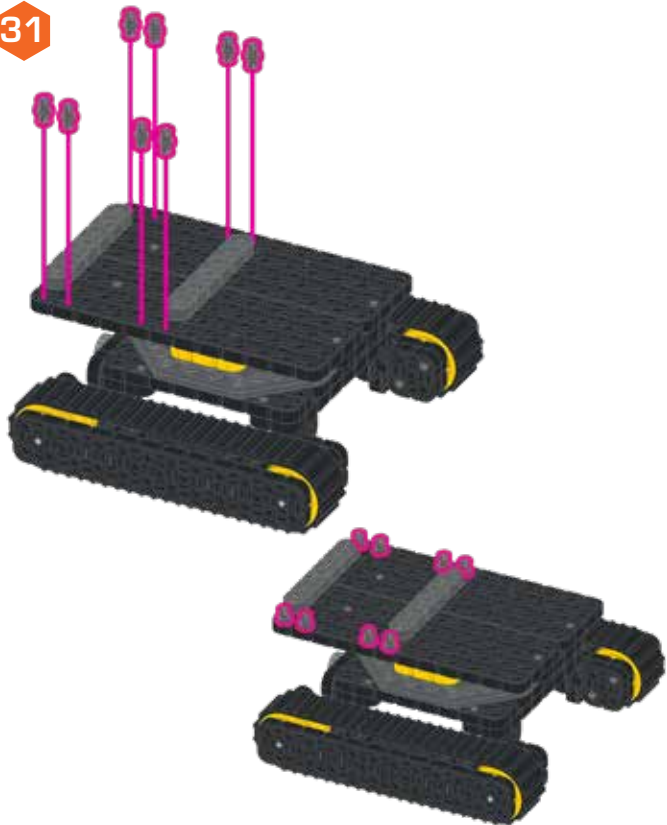

32

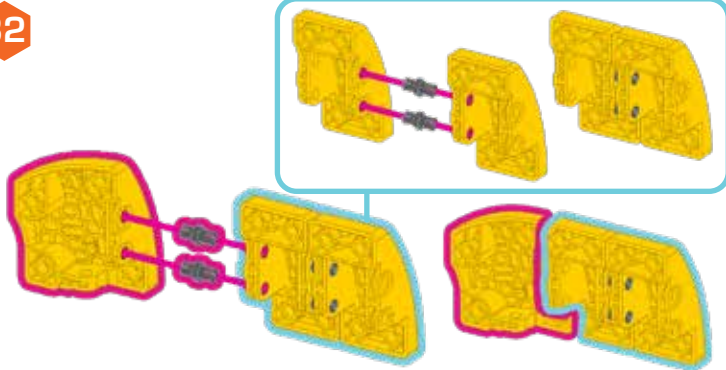

33

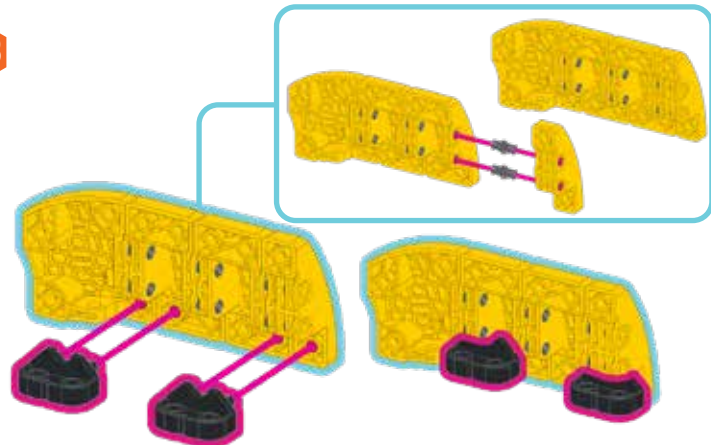

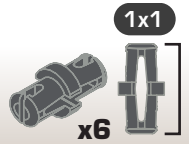
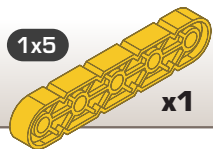
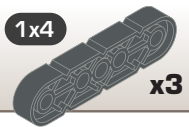

1:1

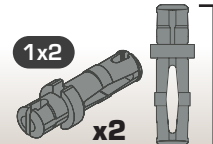

1:1

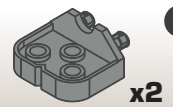

34

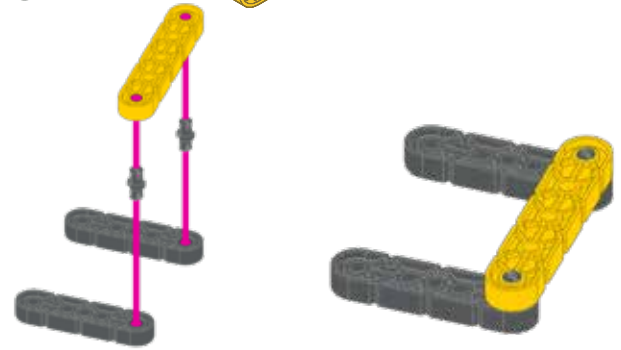

35

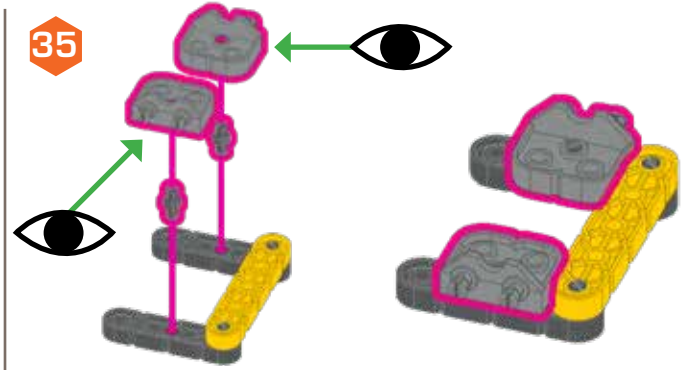

36

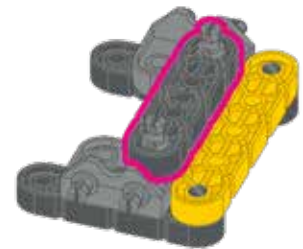

37

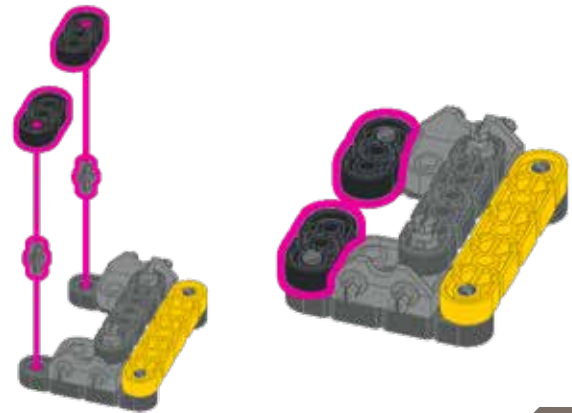

4x4

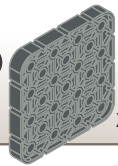

x1

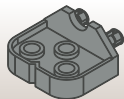

x2



x6



1x1

1:1

1x2

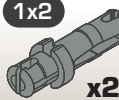

x2



1:1

38

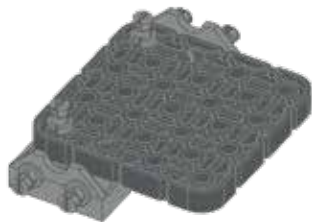
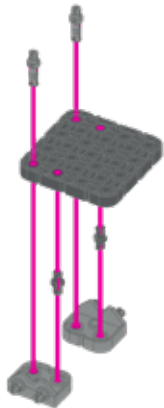

40

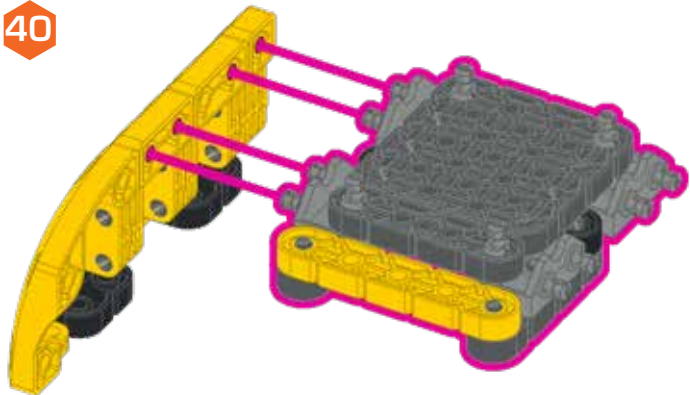

39

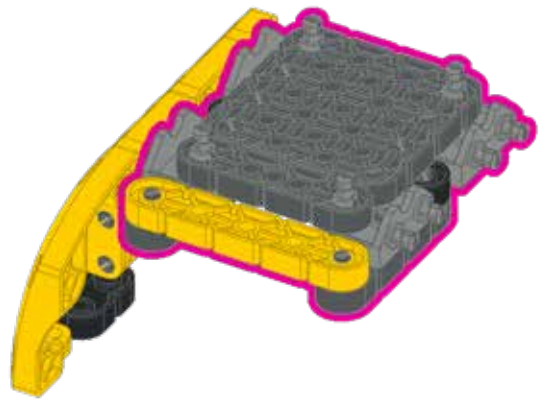
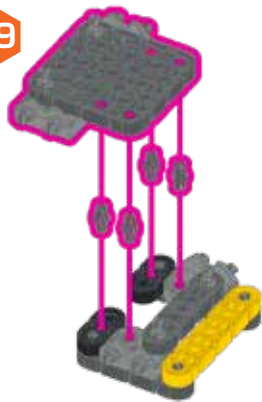



41

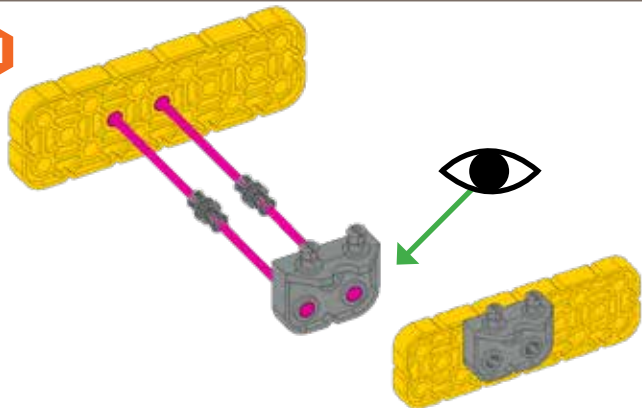

42

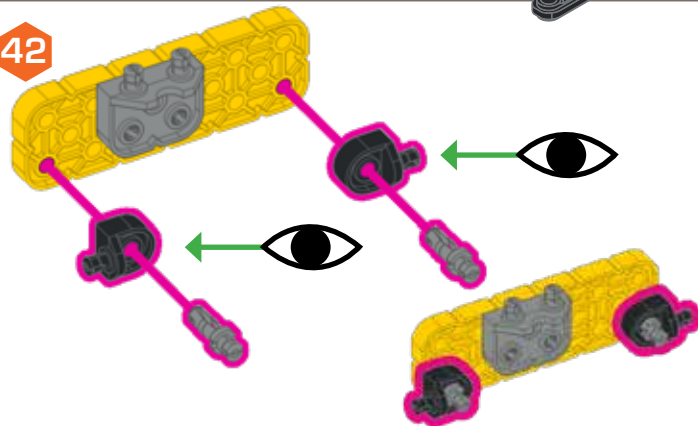

43

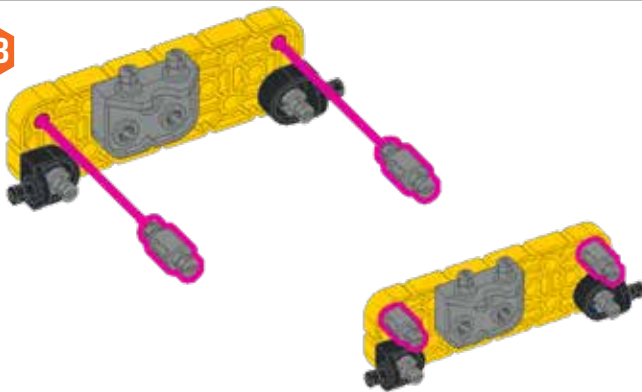

44



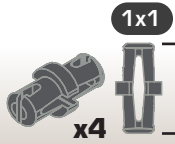
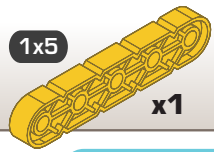

1:1



45

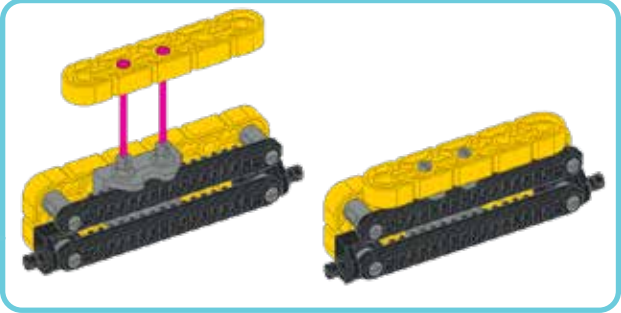

46

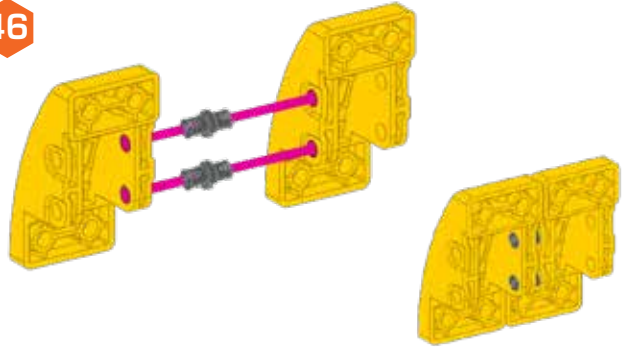

47

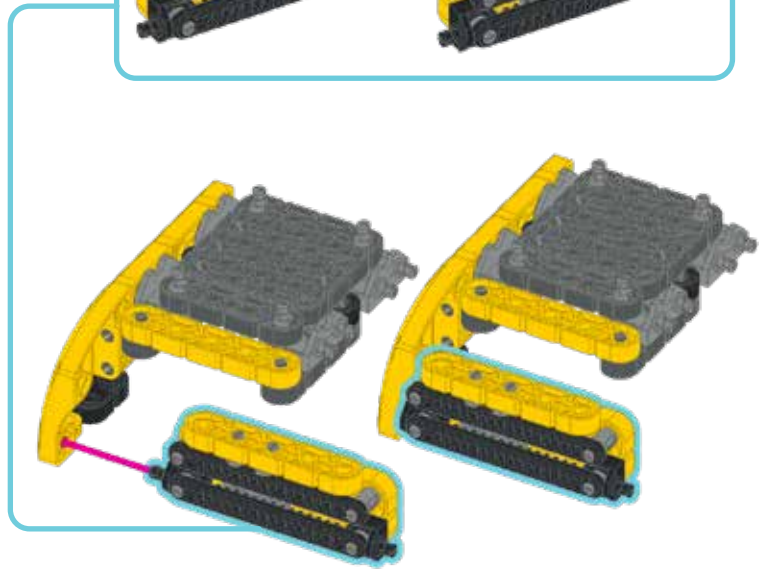
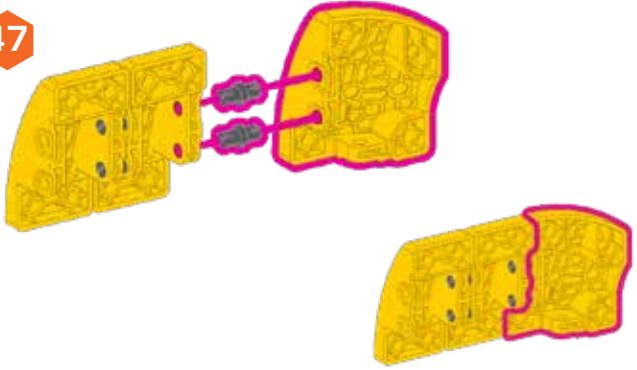

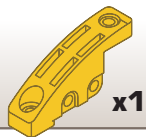

x1

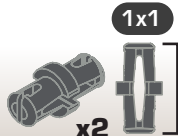

x2



1:1

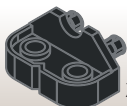

x2

48

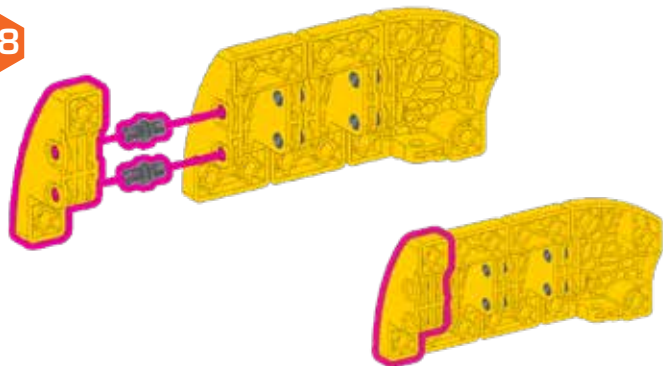

49

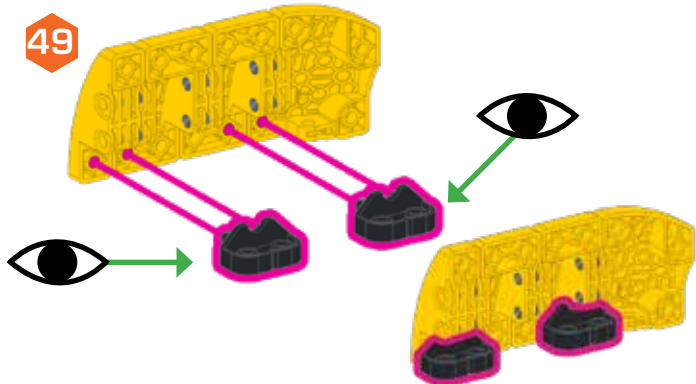

50

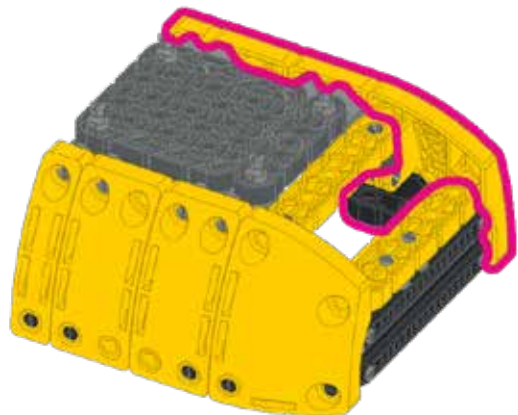
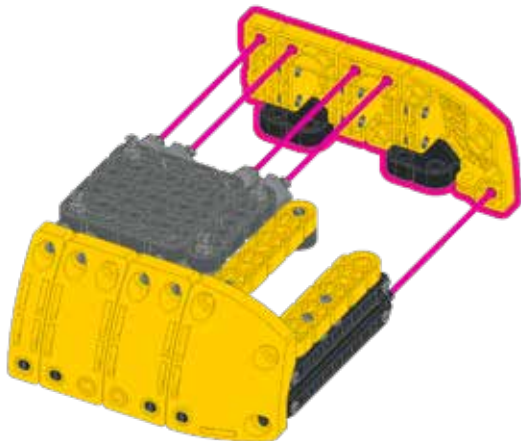

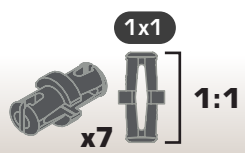

51

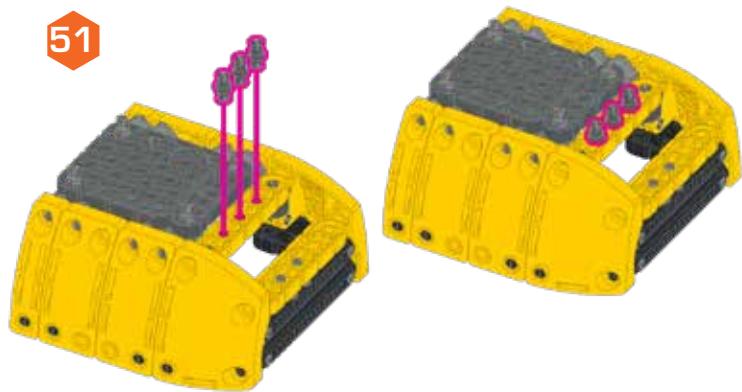

53

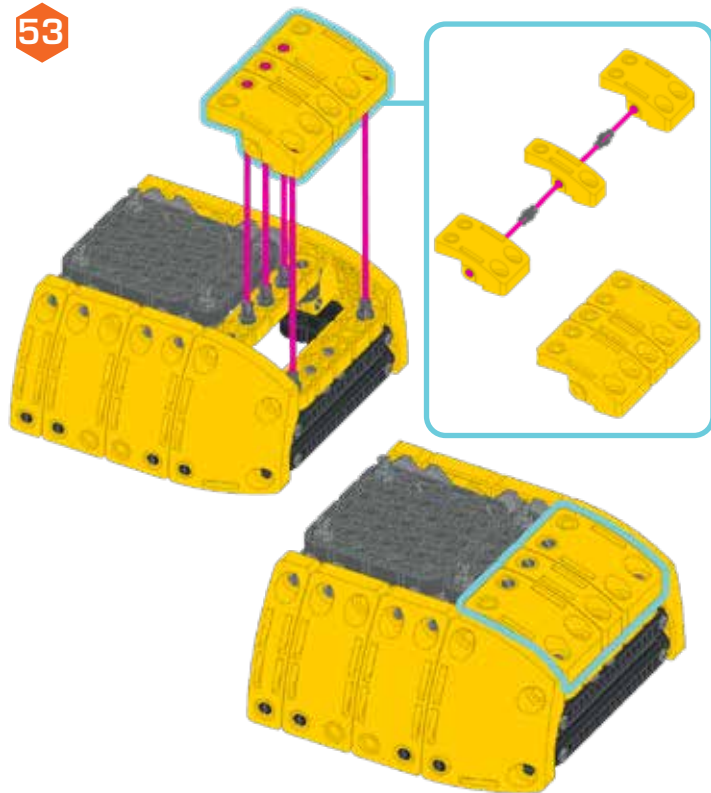

52

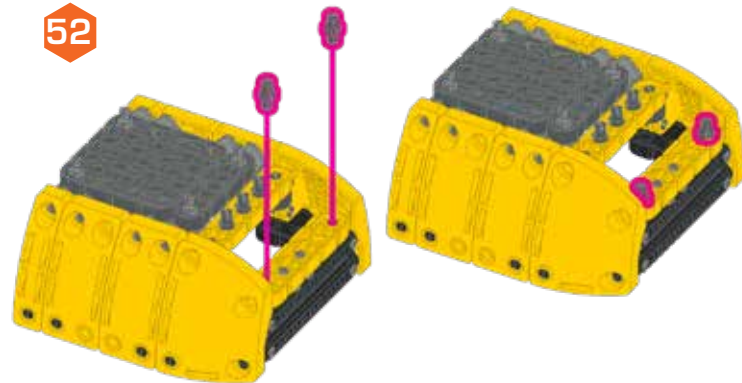

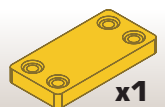
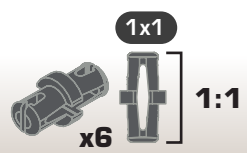

54



55





x2



x1

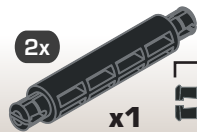

2x

x1



1:1

56



57



58

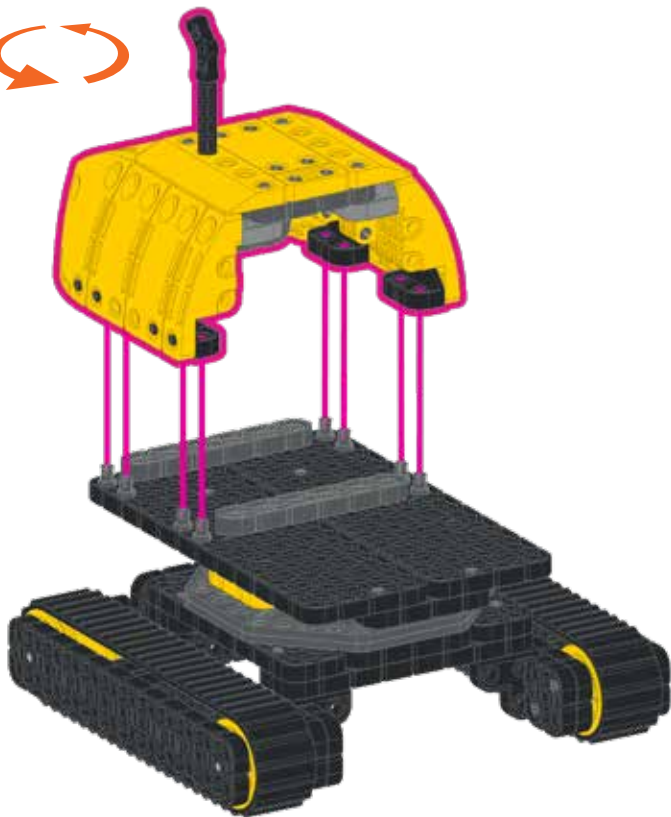

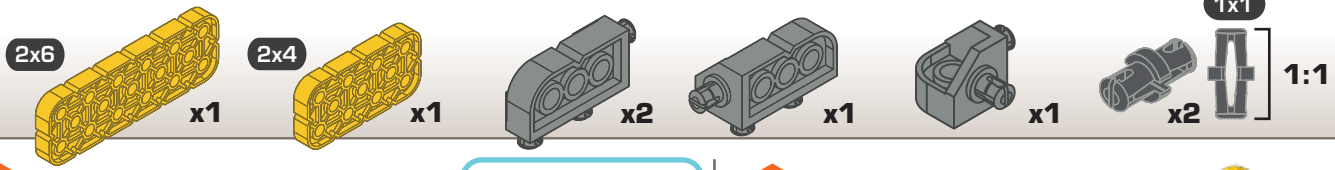

59

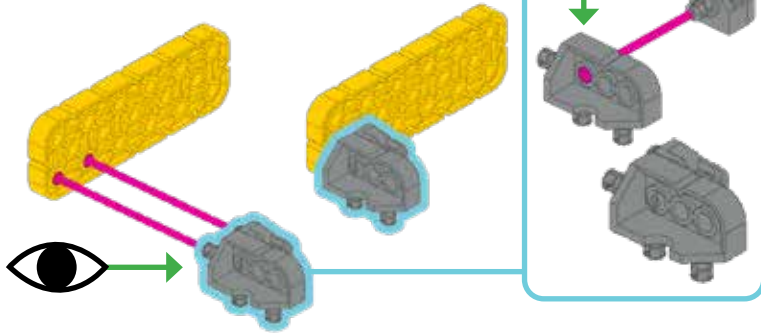

60

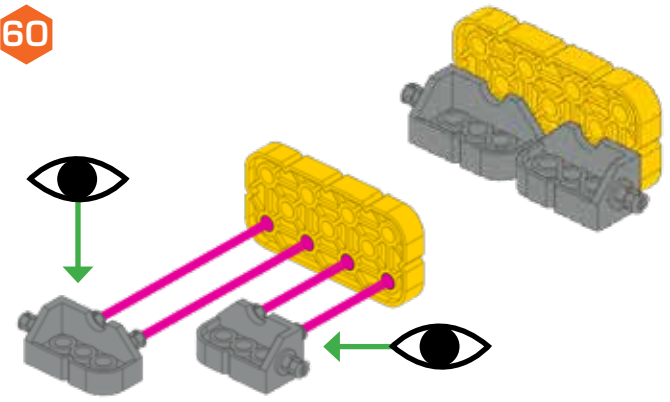

61

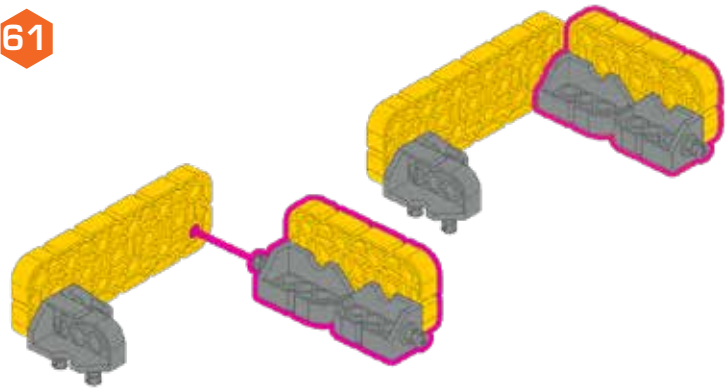

62

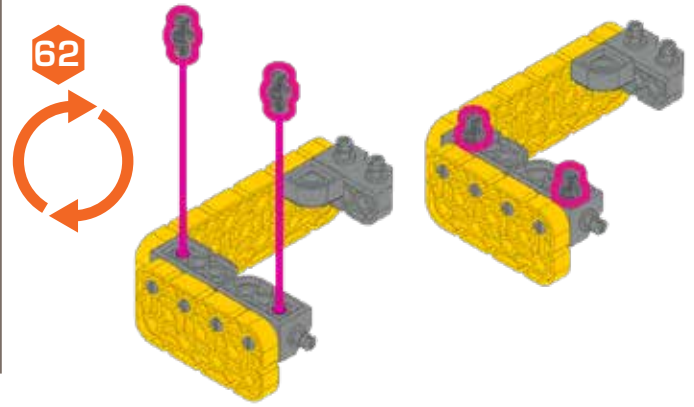

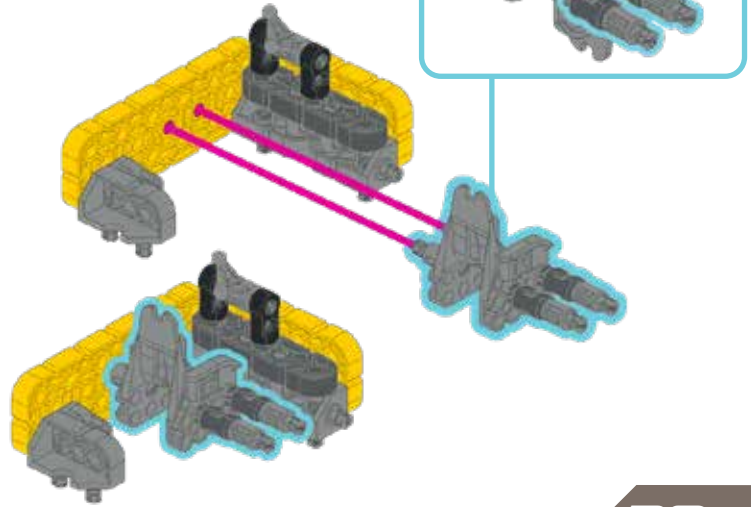
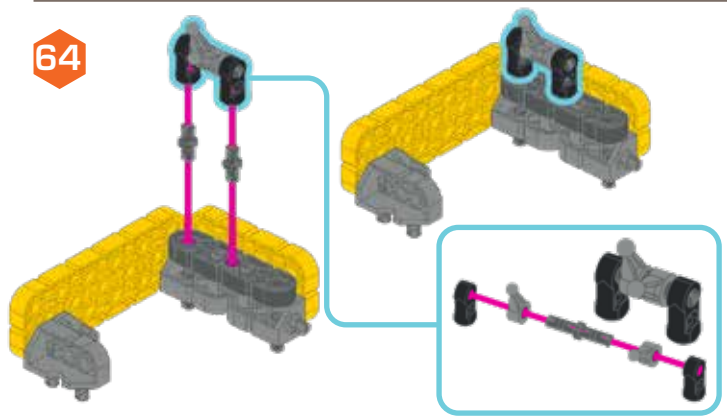
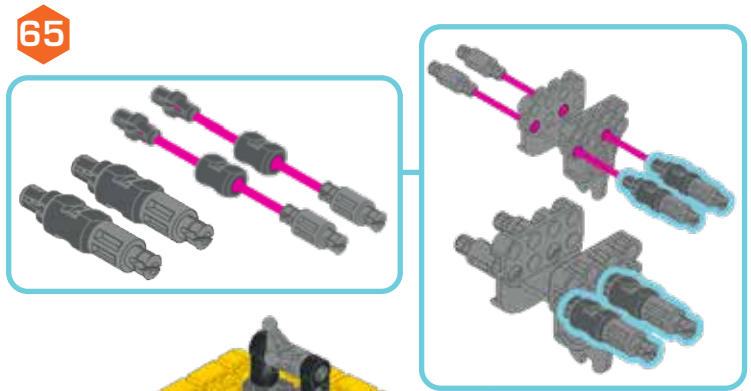
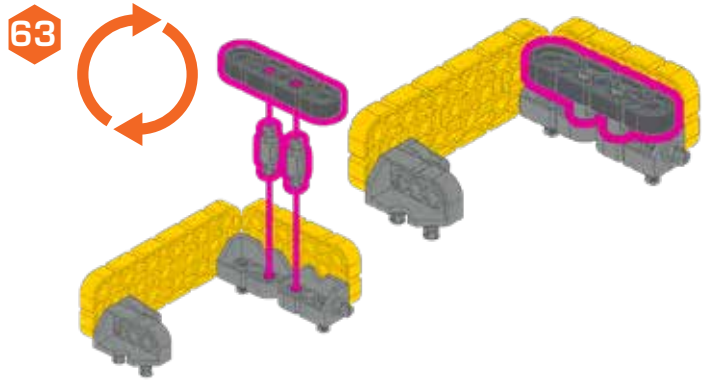
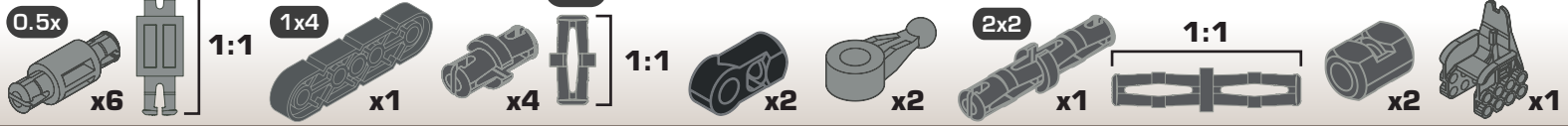

0.25x



x1



1:1



x1

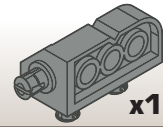

x1



x1

2x6

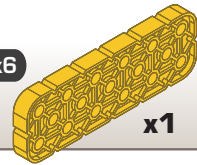

x1

66

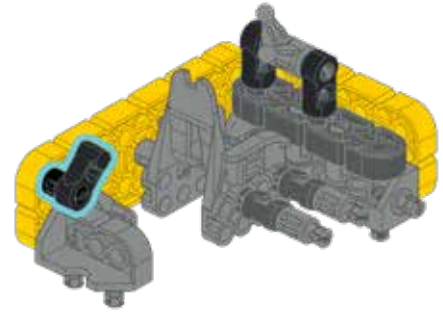
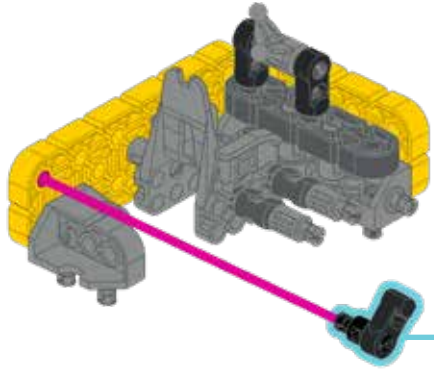

67

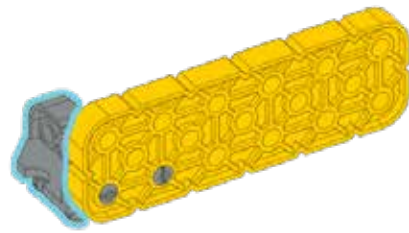
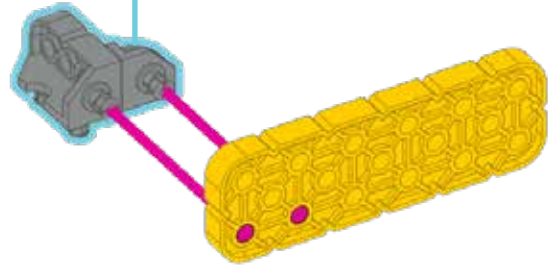
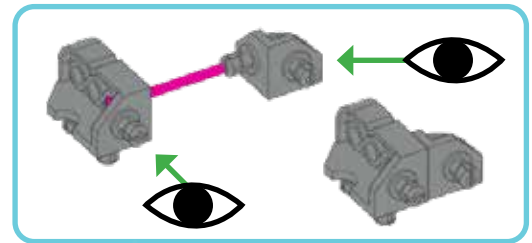

0.25x



x1



1:1



x1

68

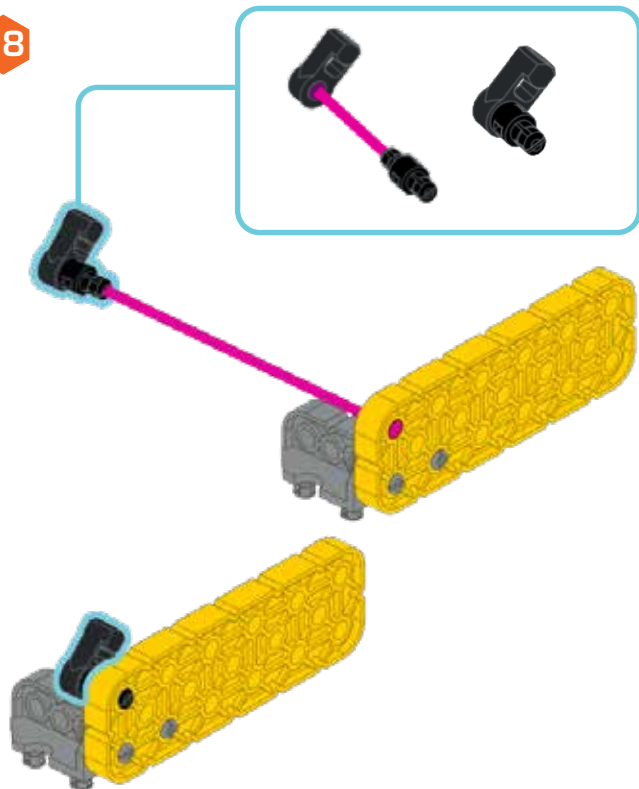

69

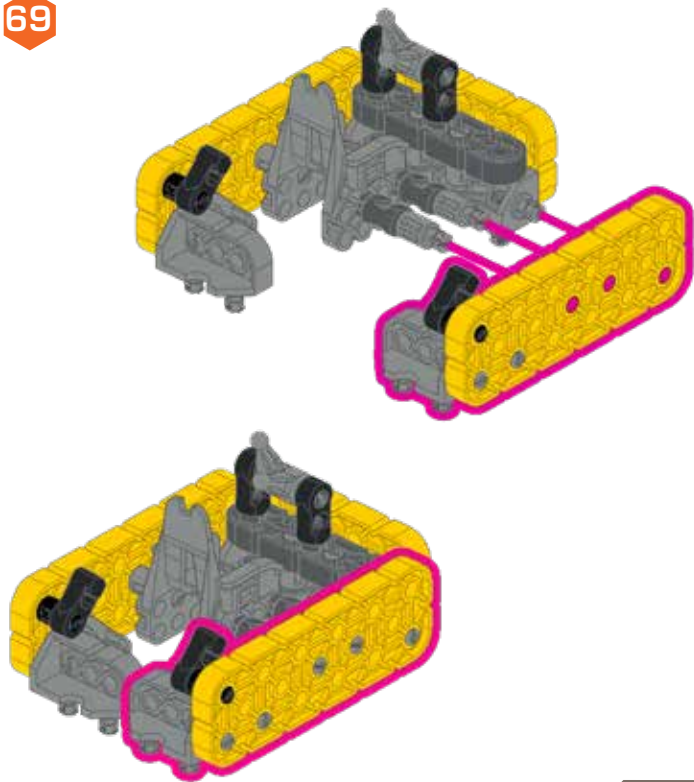

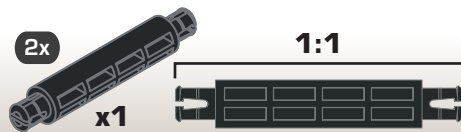
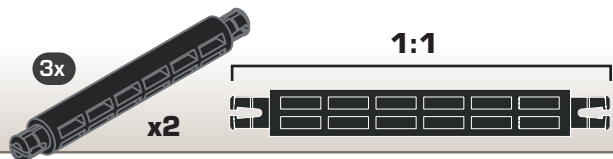

70 2X



72

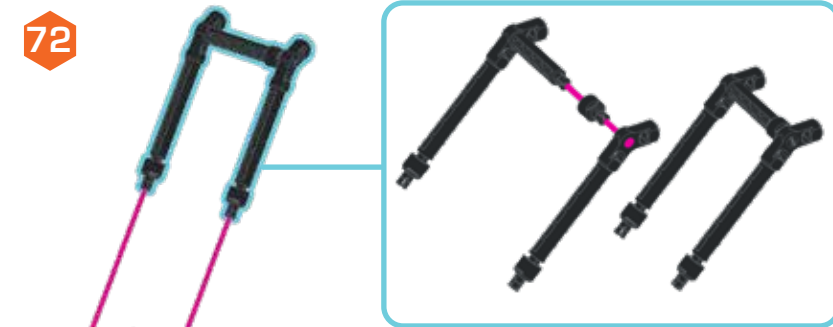

71

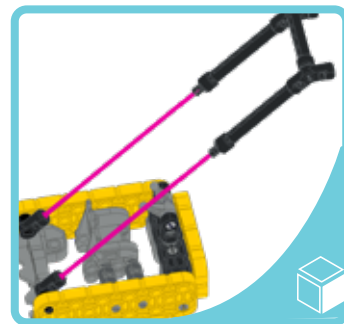

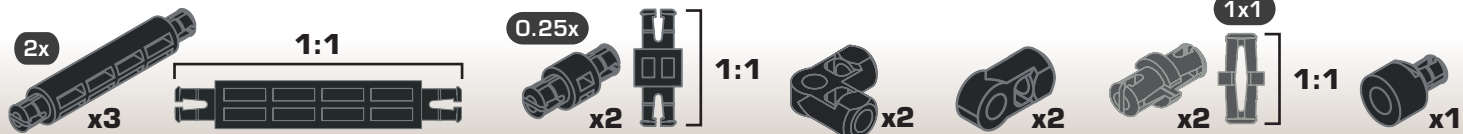

73 2X

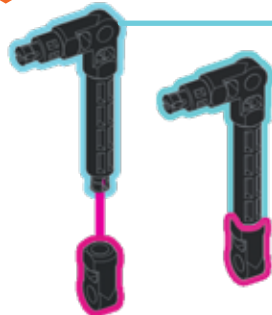

75

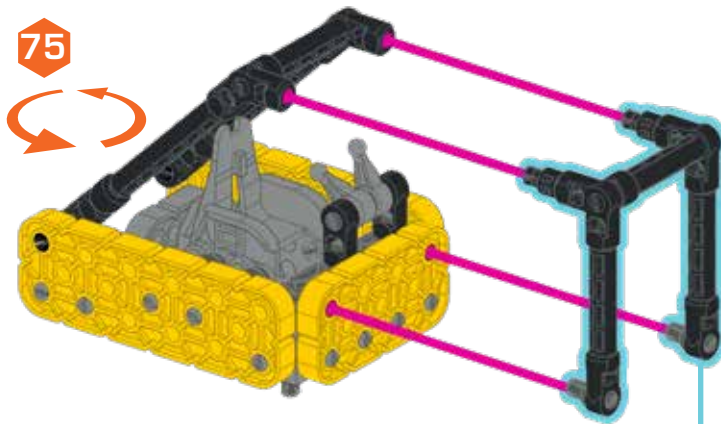

74



2X

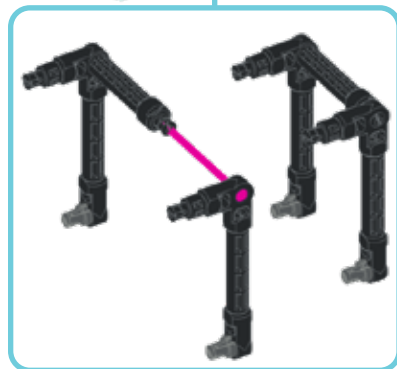

76

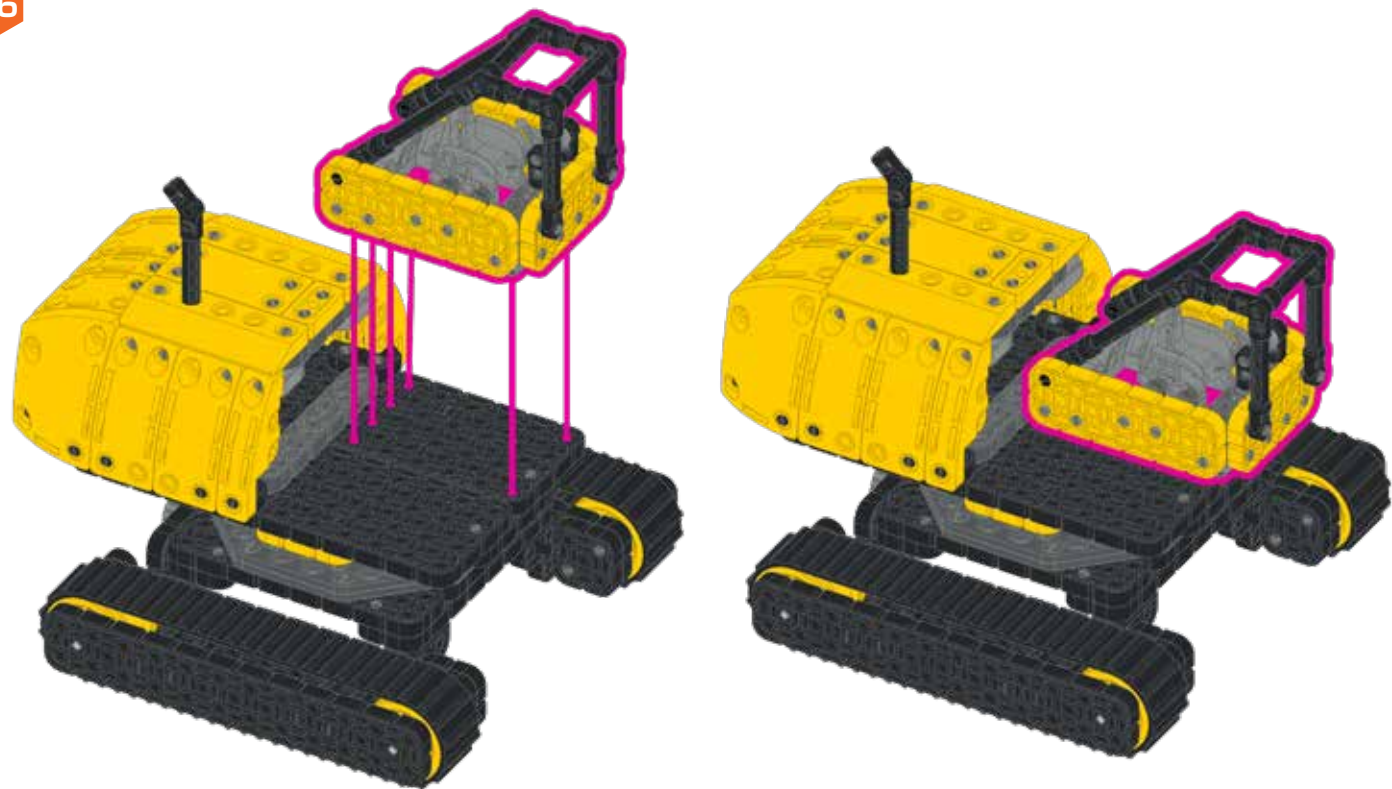

4x6

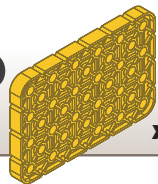

x1

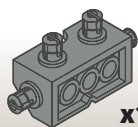

x1

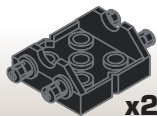

x2

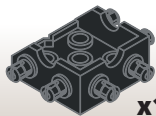

x1

77

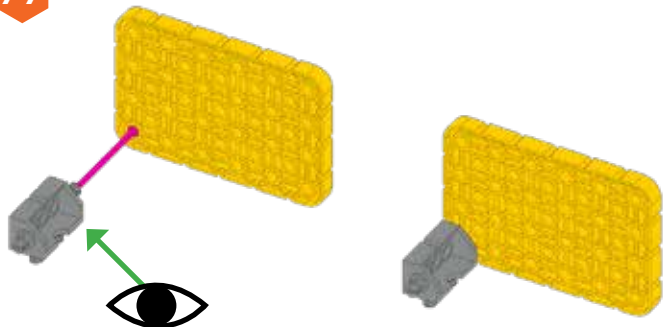

78

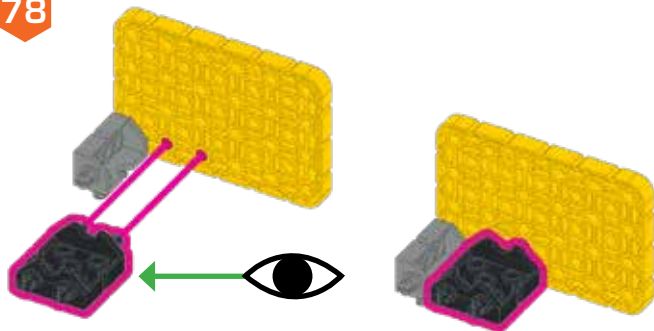

79

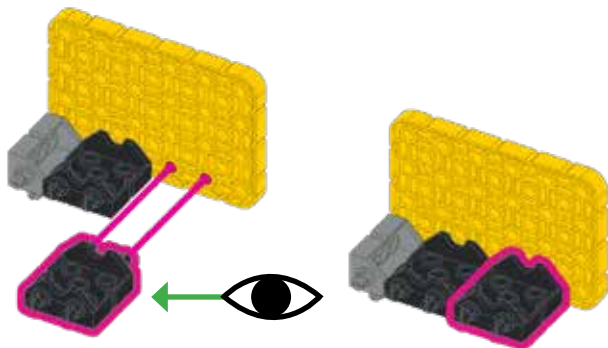

80

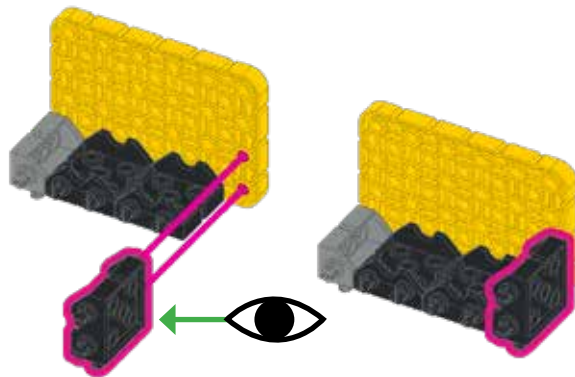



x2



x4



1x1

1:1

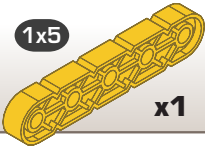

x1

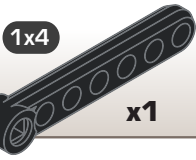

1x4

x1



x1

12t



x1

81

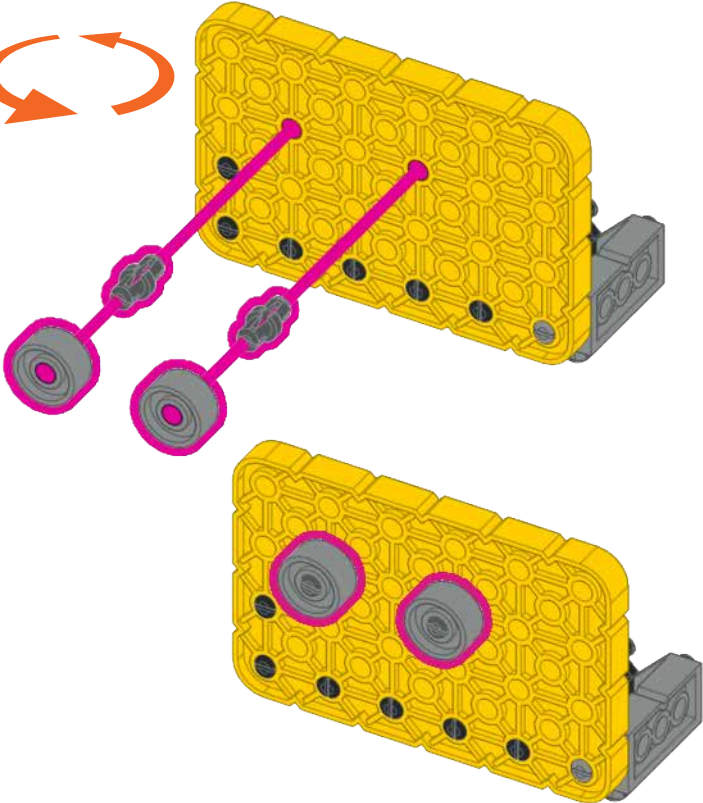

82

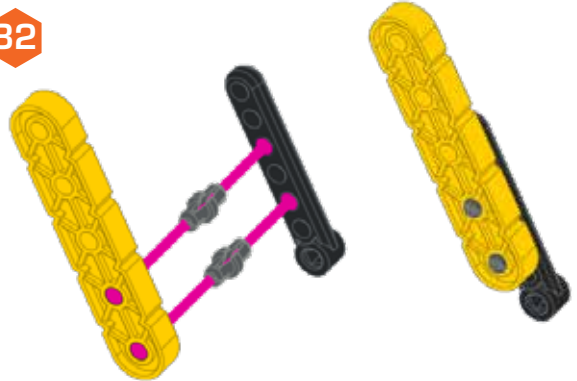

83



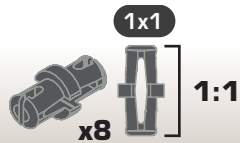
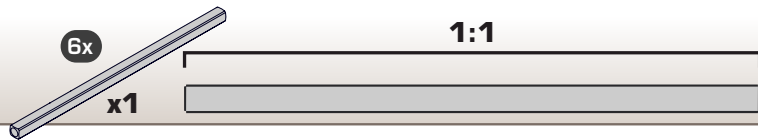

84

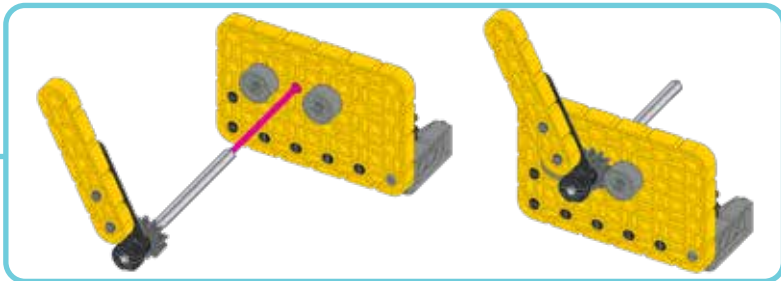
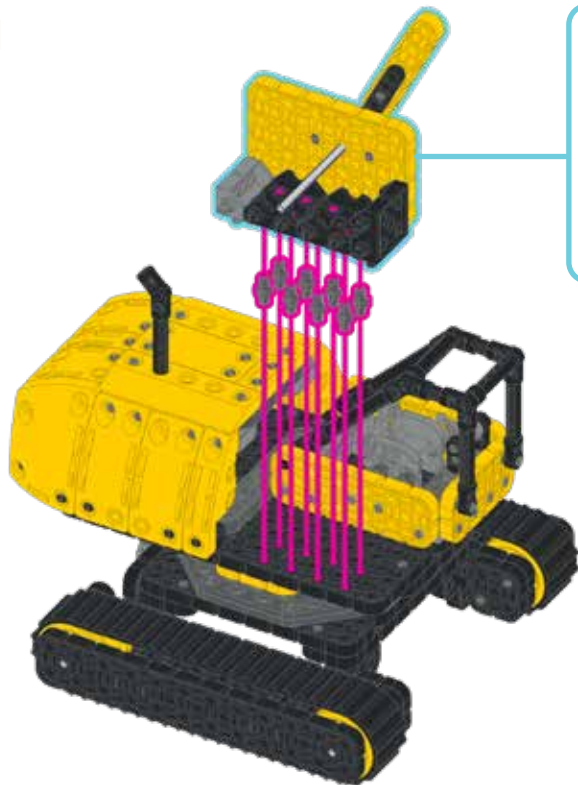

1x12

x2



x1



x3



1x1

1:1

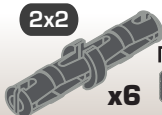

2x2

x6



1:1

1x3

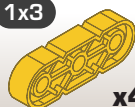

x4

1x13

x2

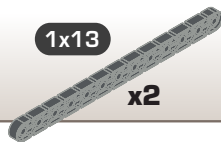

85



86

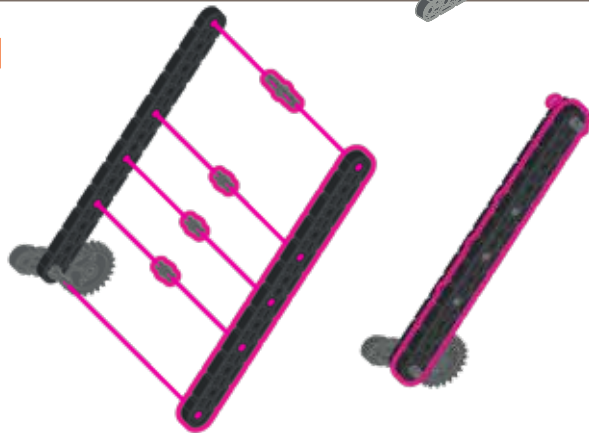

87

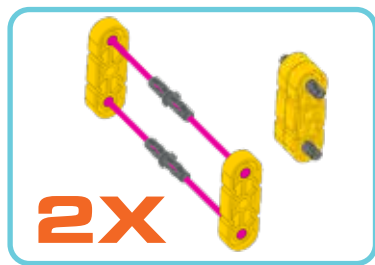

2X

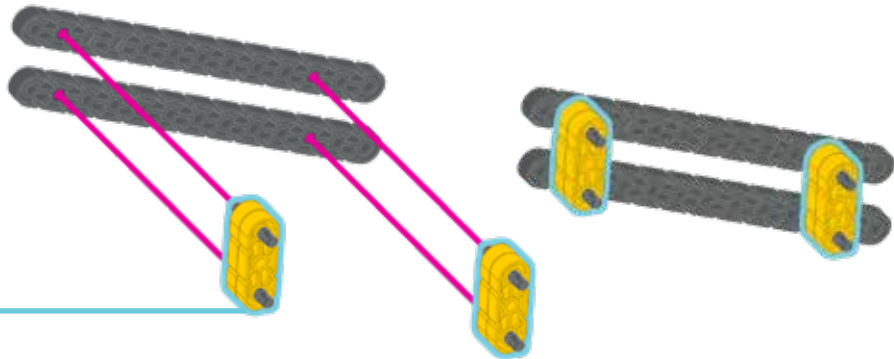

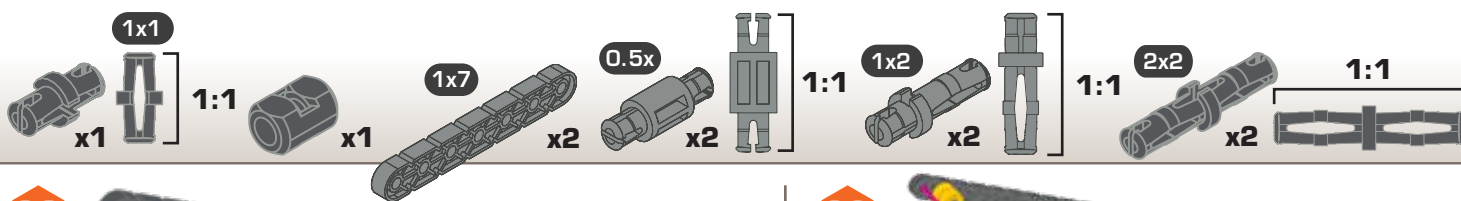

88

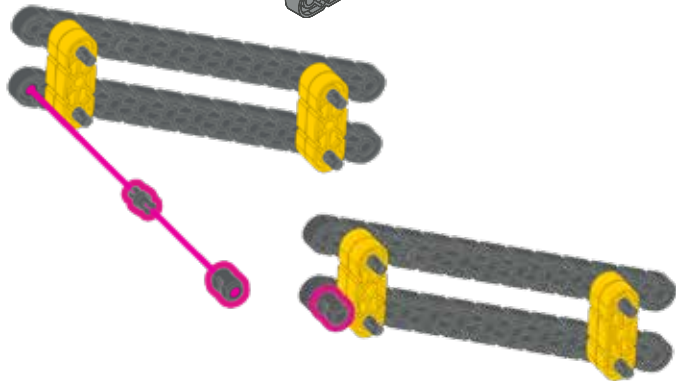

89

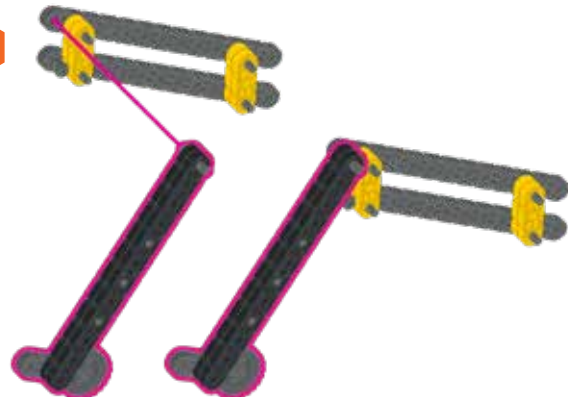

90

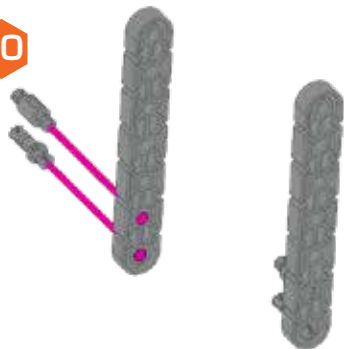

91

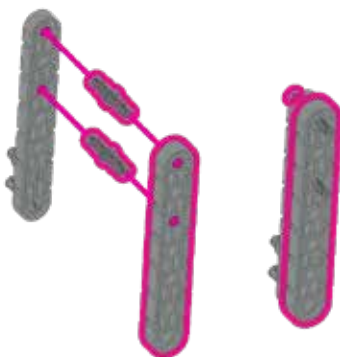

92

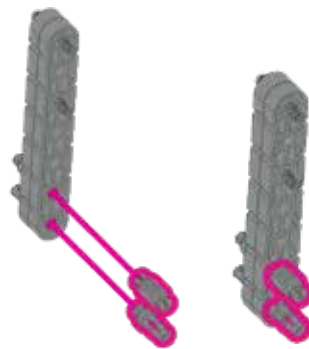

1x13

x2

1x6

x1

2x3

x1

1x1

x2

1:1

2x2

x1

1:1

93

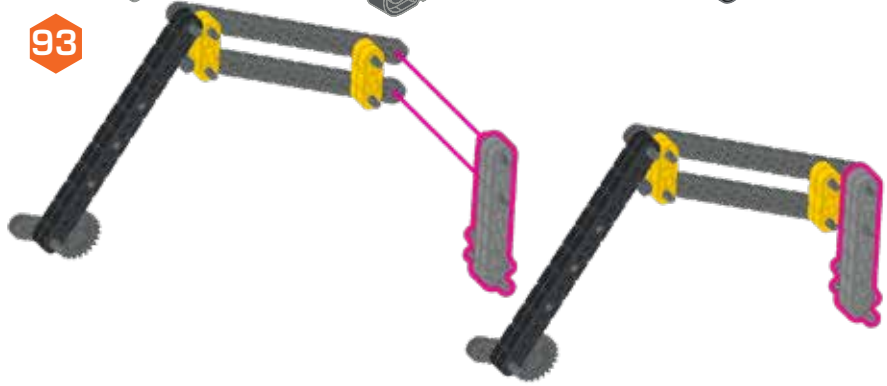

94

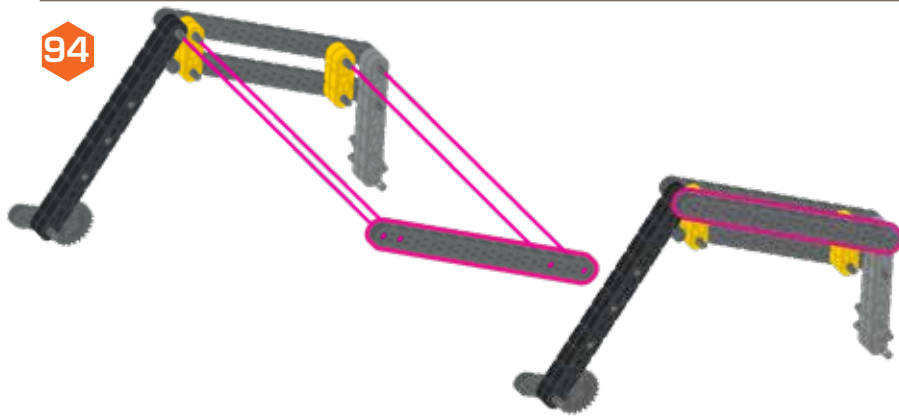

95

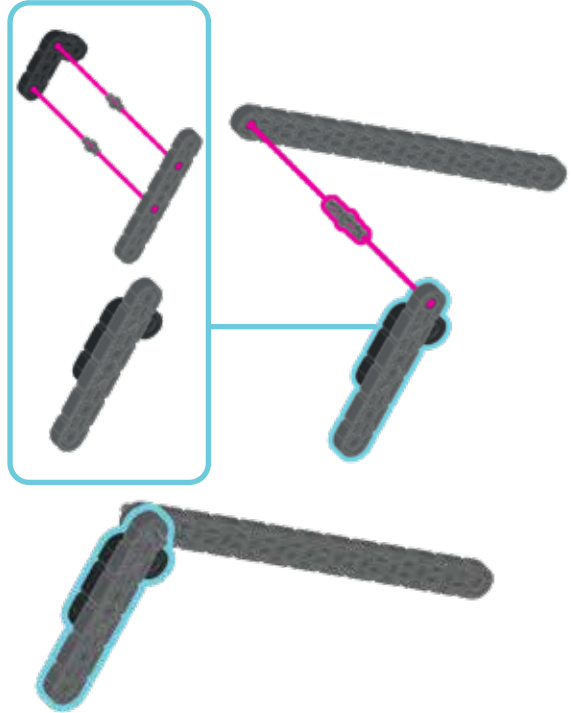

1x3



x2

3x3 45°



x2



x4



1x1

1:1

2x

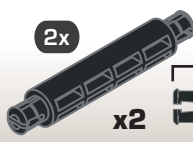

x2

1:1

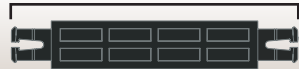

96

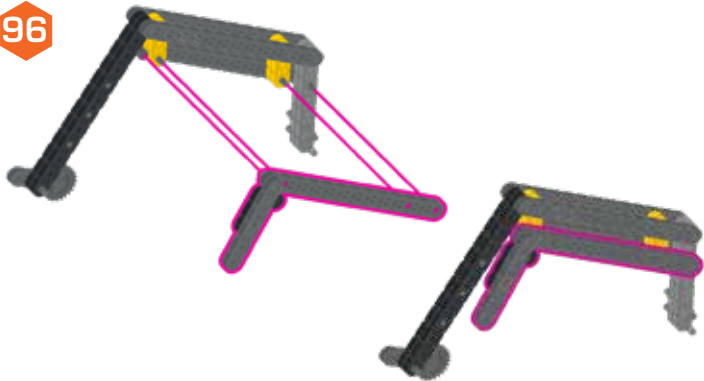

97

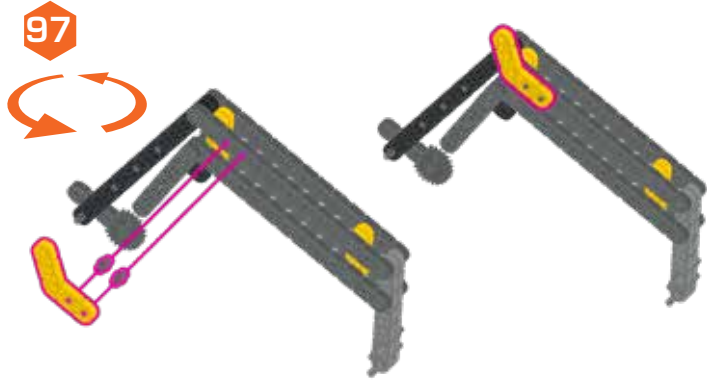

98

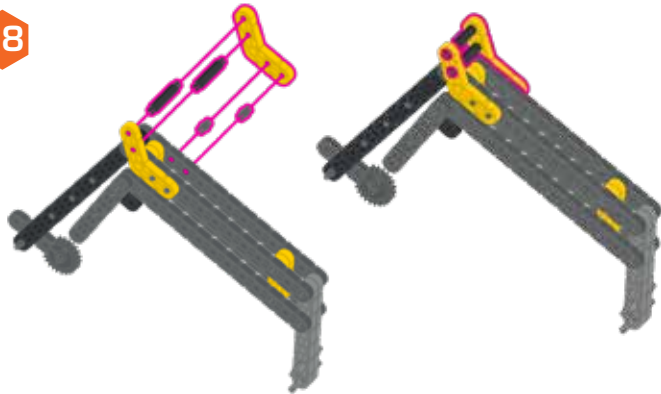

99



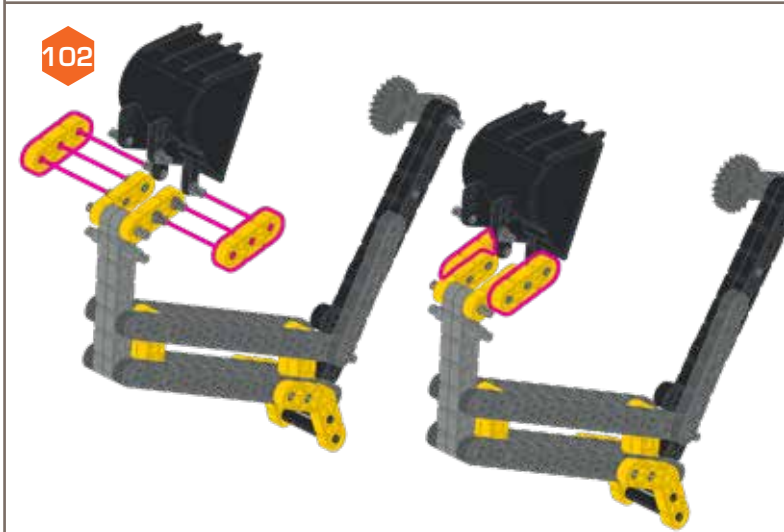
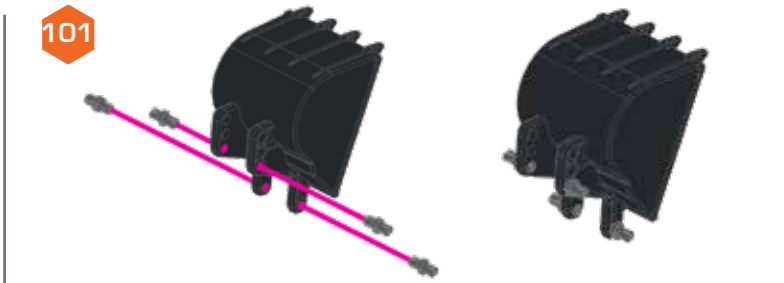
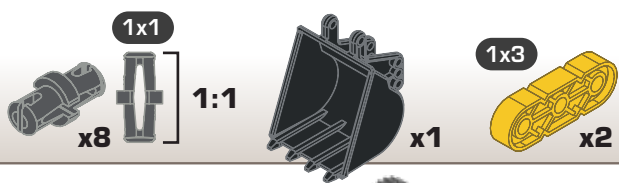

3x3 30°



x2



x1

103

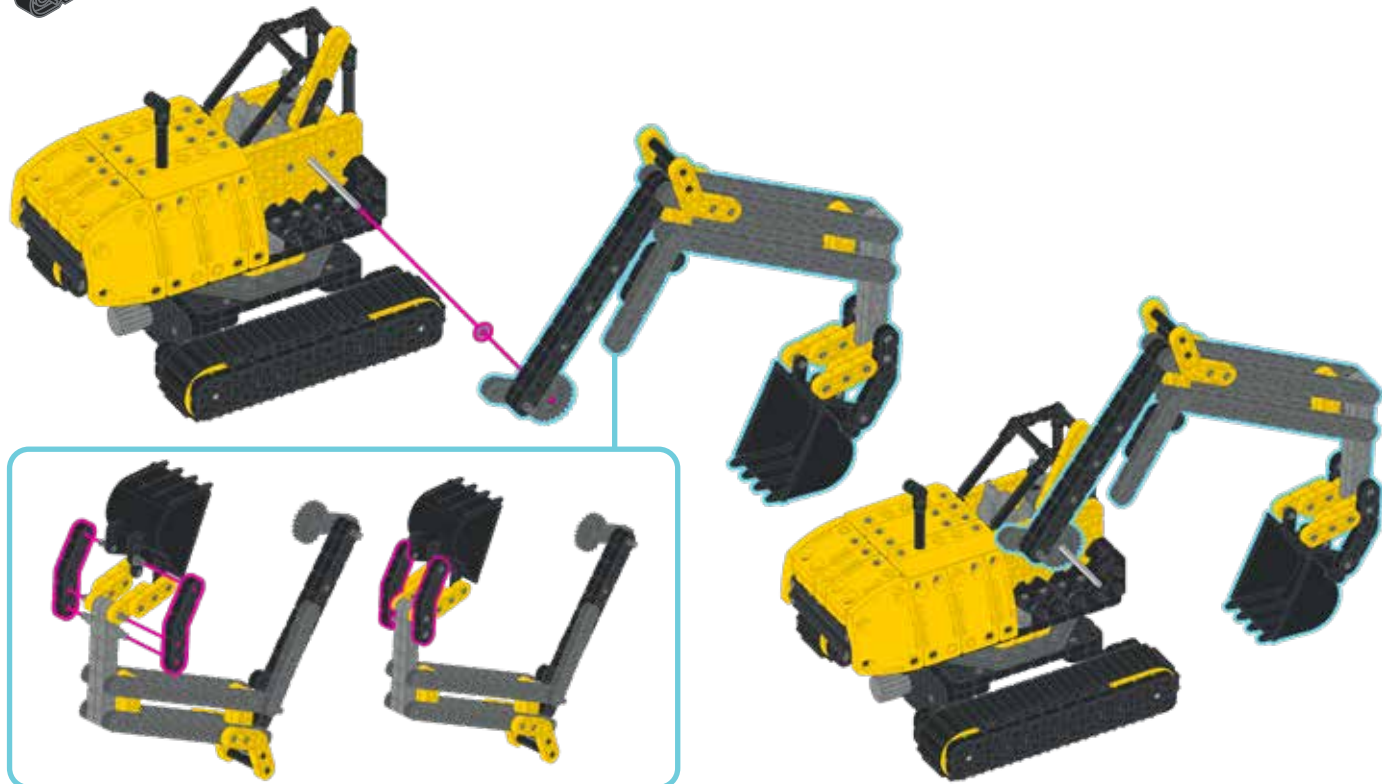



x1



x3



x1

104

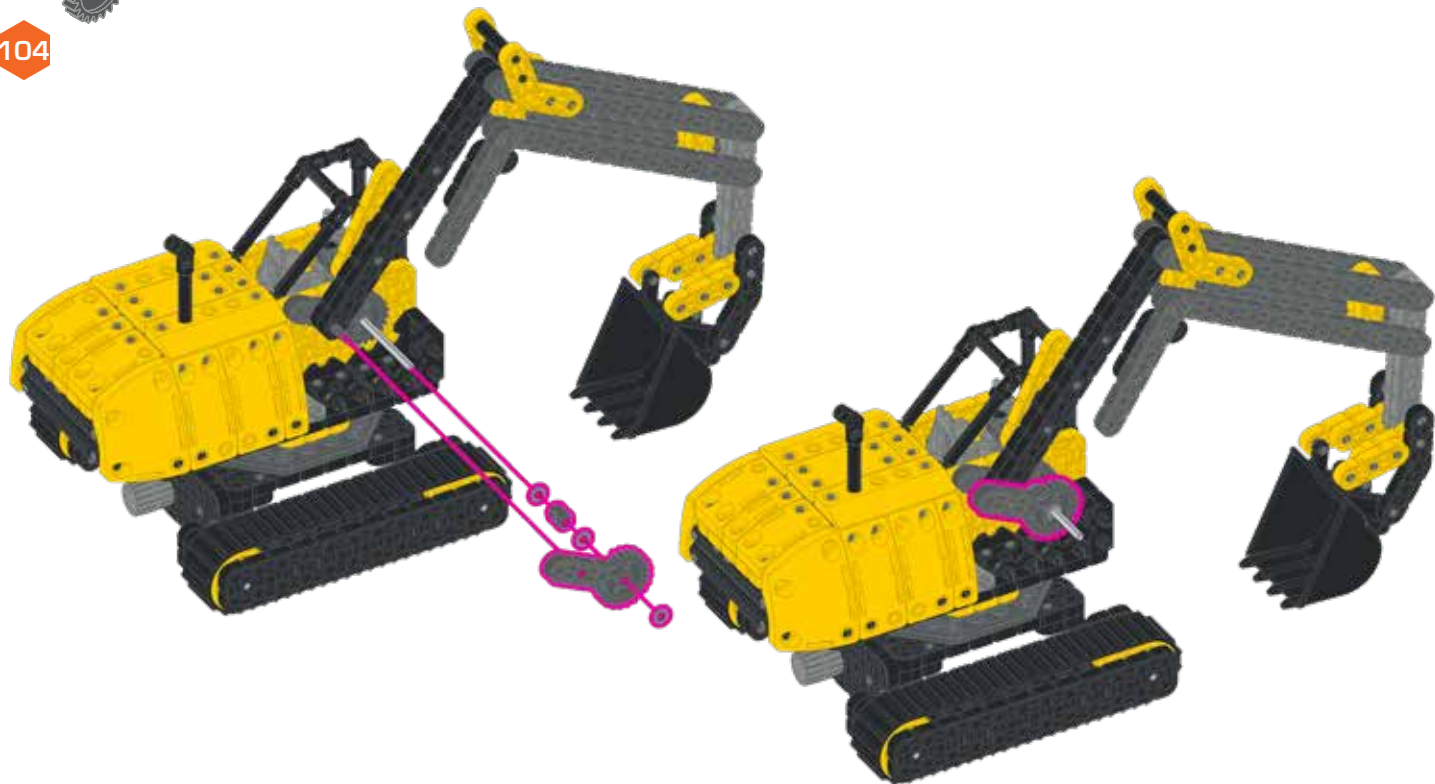

3x6

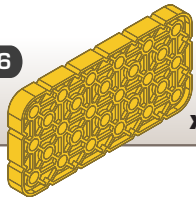

x1



x2



x2



1x1

1:1

105

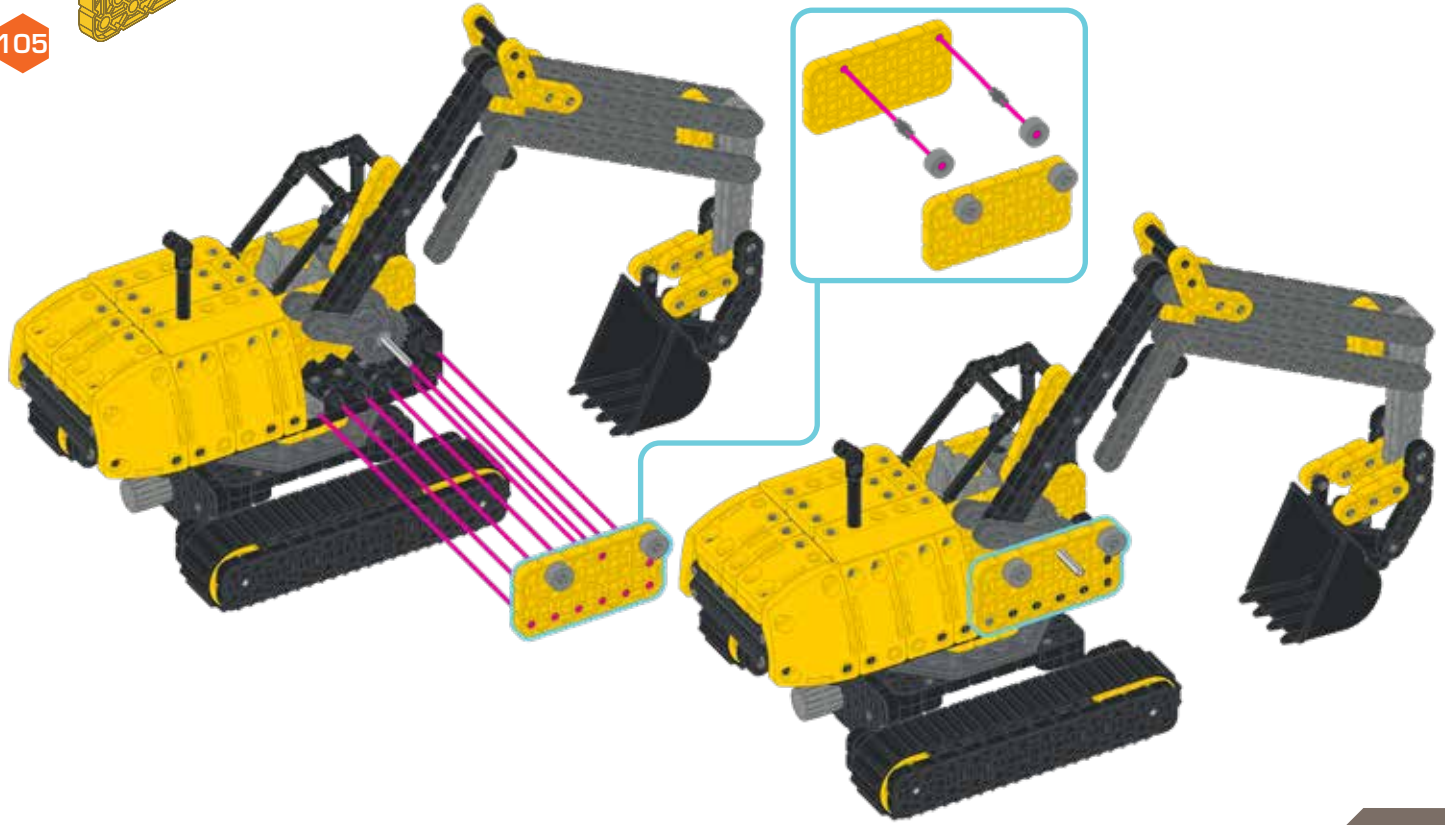

3x5



x1



x1



x3

1x1



1:1

1x8

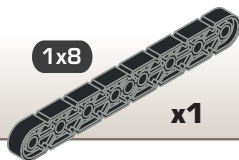

x1

1x2



x1



1:1

106



107



108



109



1x4



x1



x1



1x1

1:1



x2



x1

110

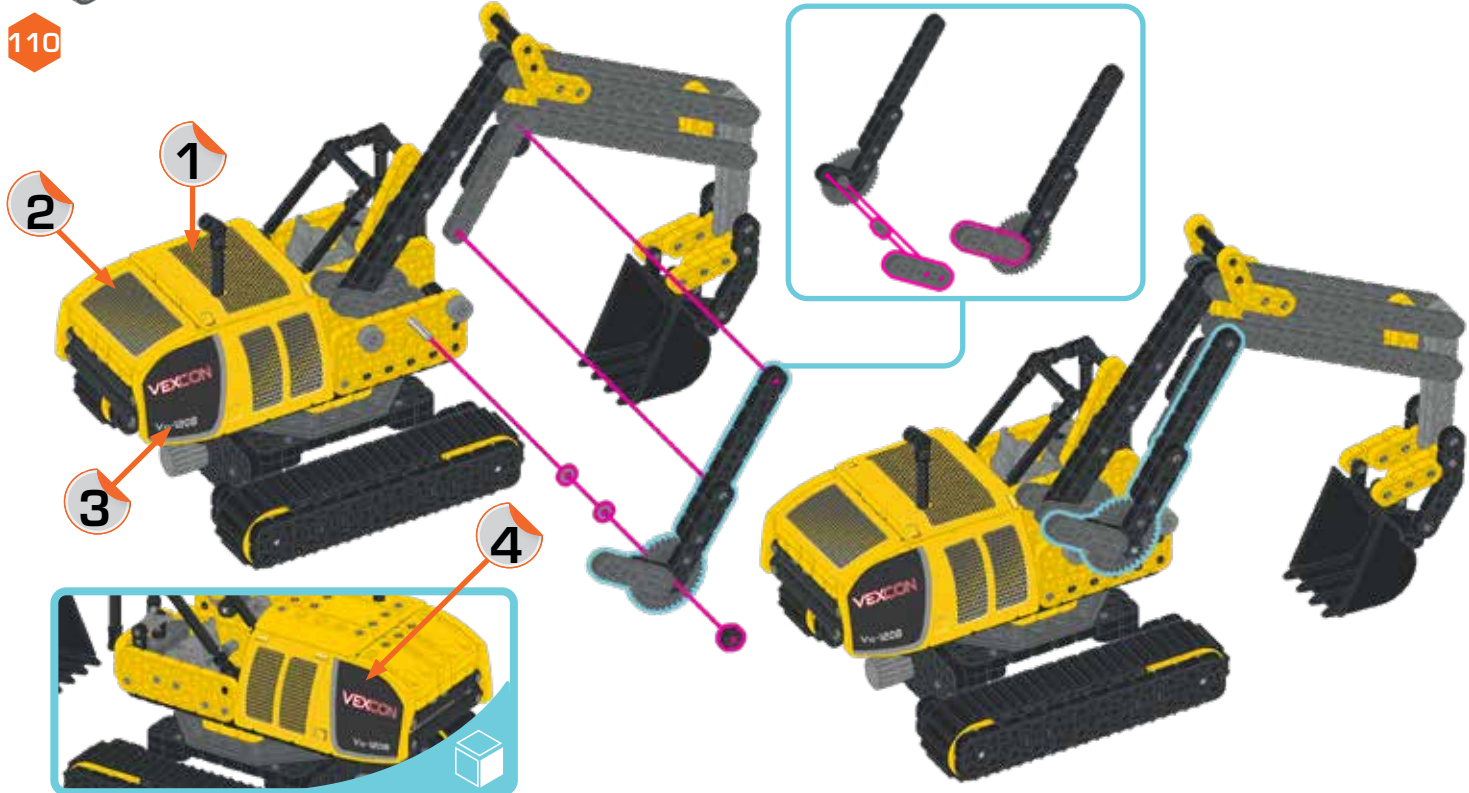

**HOW TO/ COMMENT/ CÓMO/ KURZANLEITUNG/ COME FARE/
INSTRUKTAZ/ NÄIN LEIKIT/ GÖR SÅ HÄR/ HVORDAN/ VEJLEDNING**





HEXBUG® and VE® are registered trademarks of / sont des marques de commerce de/son marcas comerciales de/ ist ein eingetragenes Warenzeichen von/ è un marchio registrato di/est zastrzeżonym znakiem towarowym firmy/ on rekisteröity tuotemerkki/är et registrerat varumärke för/er et registreret varemärke tilhørende/ er et registreret varemärke tilhørende Innovation First, Inc./ The item inside this package may vary from the photographs and /or illustrations. Please retain package for future reference. Please remove all packaging material before giving to children. This product conforms to the safety regulations. Made and assembled in China. Do not put toy in mouth/ L'objet dans cet emballage peut différer des photographies et/ ou des illustrations. Veuillez conserver cet emballage pour consultation ultérieure. Enlevez tout l'emballage avant de donner le jouet à des enfants. Ce produit est conforme aux normes de sécurité. Fabriqué et assemblé en Chine. Ne pas mettre le jouet dans la bouche/ El artículo dentro de este empaque puede variar de las fotografías y/o ilustraciones. Conserve este empaque para futuras referencias. Retire todo el material de empaque antes de dar el juguete a los niños. Este producto cumple con las normas de seguridad. Fabricado y ensamblado en China. No se ponga el juguete en la boca. / Der in dieser packung enthaltene artikel kann von den fotos und/oder abbildungen abweichen. Bitte bewahren sie die verpackung auf, damit sie später ggf. Auf diese information zurückgreifen können. Entfernen sie sämtliche verpackungsmaterialien, ehe sie das spielzeug einem kind aushändigen. Dieses produkt entspricht den sicherheitsbestimmungen. Hergestellt und zusammengebaut in China. Das Spielzeug nicht in den Mund stecken/ L'articolo all'interno della confezione può non essere identico alle fotografie e/o illustrazioni. Conservare la confezione per riferimento futuro. Rimuovere tutti i materiali da imballaggio prima di consegnare a bambini. Questo prodotto è conforme alle norme di sicurezza/ Non mettere il giocattolo in bocca/ przedmiot wewnątrz opakowania może różnić się wyglądem od zdjęć i/lub ilustracji. Proszę zachować opakowanie jako źródło informacji na przyszłość. Proszę wyjąć produkt z opakowania przed oddaniem go dziećmi. Produkt spełnia normy bezpieczeństwa. Wymietlętu ja koottu kínassa/ tämän pakkaus sisältää oleva tuote voi poiketa valokuvista ja/ai kuvista. Säilytä pakkaus tulevaa tarvetta varten. Poista kaikki pakkausmateriaalit ennen tuotteen antamista lasten käsiin. Tämä tuote noudattaa turvallisuusmääräyksiä. Tilverkad och monterad/ produkten i denna förpackning kan skilja sig från fotografier och/eller illustrationer. Spara förpackningen för framtida referens. Avläs alla förpackningsmaterial innan produkten ges till barn. Produkten följer säkerhetsbestämmelserna. Laget og monteret i Kina/ elementet i denne pakke kan variere fra fotografier og/eller tegninger. Gem venligst pakken til fremtidig reference. Fjern al emballage før enheden gives til børn. Dette produkt opfylder sikkerhedsforskrifterne. Fabricado e montado na China. / Copyright © 2021 Innovation First, Inc. All Rights Reserved/ Tous droits réservés. / Todos los derechos reservados/ Alle Rechte vorbehalten/ Tutti i diritti riservati/ Wszystkie prawa zastrzeżone/ Kaikki oikeudet pidätetään/ Alla rättigheter förbehålls/ Alle Rettigheter Reservert/ Alle rettigheder forbeholdes/ For information concerning Hexbug's Limited Warranty-- www.hexbug.com/policies; For customer service in your region go to: www.hexbug.com/contact/ Pour plus d'informations sur la garantie limitée de Hexbug -- www.hexbug.com/policies; Pour le service client de votre région, rendez-vous sur: www.hexbug.com/contact / Pour plus d'informations sur la garantie limitée de Hexbug -- www.hexbug.com/policies; Pour le service client de votre région, rendez-vous sur: www.hexbug.com/contact / Para obtener información sobre la garantía limitada de Hexbug visite: www.hexbug.com/policies; Para comunicarse con el servicio al cliente de su región visite: www.hexbug.com/contact / Informationen zur eingeschränkten Garantie von Hexbug finden Sie unter: www.hexbug.com/policies; Den Kundendienst in Ihrer Region finden Sie unter: www.hexbug.com/contact / Per informazioni sulla garanzia limitata offerta da Hexbug -- www.hexbug.com/policies; Per il servizio clienti nella propria regione visitate: www.hexbug.com/contact / Per informazioni sulla garanzia limitata offerta da Hexbug -- www.hexbug.com/policies; Per il servizio clienti nella propria regione visitate: www.hexbug.com/contact / Informacje na temat ograniczonej gwarancji Hexbug znajdziesz na stronie: www.hexbug.com/policies; Informacje na temat obsługi klienta w Twoim regionie znajdziesz na stronie: www.hexbug.com/contact / Lisä tietoja Hexbugin rajoitetusta takuudesta: www.amo.fi; Jos haluat asiakaspalvelua alueellasi, sinry ootteeseen: www.amo-toys.com / För information om Hexbug's Begränsad garanti-- www.hexbug.com/policies; För kundtjänst i din region gå till: www.amo-toys.com / For informasjon om Hexbug's begrensede garanti-- www.hexbug.com/policies; For kundeservice i din region, gå til: www.amo-toys.com / For information vedgørende Hexbug's Begrænsat Garanti-- www.hexbug.com/policies; For kundeservice i dit område gå til: www.amo-toys.com

Custom manufactured in / Fabriqué sur mesure en / Fabricado a medida en / Hergestellt in / Prodotto in / Op maat gefabriceerd in / Fabricado à medida na / Wykonane na zamówienie w/ Mittaltaustayönä valmistettu / Tilverkad i / Spezialproduziert i / Specialfremstillet i / 定制生產於 China For Innovation First Trading SARL. Distributed in the U.S.A. by / Distribué aux états-unis par / Distribuido en los EE. UU. por / Vertrieb in den USA durch / Distribuito negli U.S.A. da / Gedistribueerd in de VS door / Distribuido nos EUA pela / Dystrybuowane w USA przez/ Jaettu USA: ssa/ Distribueras i USA av/ Distribuit i USA av/ Distribuit i USA av/ 美國地區經銷商 Innovation First Labs, Inc., 6725 W. Fm 1570, Greenville, Texas 75402, U.S.A. Distributed in Europe by / Distribué en Europe par / Distribuido en Europa por / Vertrieb in Europe durch / Distribuito in Europa da / Gedistribueerd in Europe door / Distribuido in Europa pela / Dystrybuowane w Europie przez/ Maahantuja Euroopassa/ Distribueras i Europa av/ Distribuit i Europa av/ Distribueret i Europa av/ 歐洲地區經銷商 Innovation First Trading SARL, Parc Z.A.E. Wolser G, 314 3434 -- Dudelange, Luxembourg. Distributed in UK by / Distribué en UK par / Distribuido en UK por / Vertrieb in UK durch / Distribuito in UK da / Gedistribueerd in UK door / Distribuido na UK pela / Dystrybuowane w UK przez/ Maahantuja UK/ Distribueras i UK av/ Distribuit i UK av/ Distribueret i UK av/ Innovation First International (UK) Limited, 6 Melford Court, Hardwick Grange, Warrington WA1 4RZ, United Kingdom +44 (0) 1925-453144. DISTRIBUTED IN CANADA BY / DISTRIBUTÉ AU CANADA PAR / DISTRIBUIDO EN CANADA POR / VERTRIEB IN CANADA DURCH / DISTRIBUITO IN CANADA DA / GEDISTRIBUEERD IN CANADA DOOR / DISTRIBUTUO NO CANADA PELA / DYSTRYBUOWANE W KANADZIE PRZEZ/JAETTU KANADASSA/ DISTRIBUERAS I KANADA AV/ DISTRIBUERET I CANADA AV/ DISTRIBUERET I CANADA AV/ 加拿大地區經銷商 INNOVATION FIRST TRADING, INC., 6725 W. FM 1570, GREENVILLE, TEXAS 75402, U.S.A. WWW.HEXBUG.COM/CONTACT MAAHANTUOJA SUOMESSA / IMPORTÖR I FINLAND: AMO OY, ANSÄTIE 5, 01740 VANTAA/VANDA, WWW.AMO.FI, KULLUTTAJAPALVELU/ KONSUMENTSERVICE SUOMI +358 20163 0530/ IMPORTÖR I SVERIGE, DANMARK: AMO TOYS AB, GARNISONGSGATAN 10, 25466 HELSINGBORG, WWW.AMO-TOYS.COM. KONSUMENTSERVICE SVERIGE +46 722026142 / KUNDESERVICE NORGE +47 46520501 / KUNDESERVICE DANMARK +45 72170187

Please keep these instructions / Veuillez conserver le mode d'emploi. / Por favor conserve la guía de instrucciones. / Diese Anleitung bitte aufbewahren. / Conserve ueste istruzioni. / Proszę zachować niniejszą instrukcję. / Säilytä nämä ohjeet. / Spara instruktionerna. / Vennligst ta vare på disse instruksjonene. / Gem brugsanvisningen.

WARNING:
CHOKING HAZARD--Small parts.
Not for children under 3 years.

ADVERTENCIA:
RIESGO DE ASFIXIA --Pequeñas partes.
No para niños menores de 3 años.

ACHTUNG:
ERSTICKTUNGSGEFÄHR -- Kleinteile.
Nicht für Kinder unter 3 Jahren

ATTENZIONE:
RISCHIO DI SOFFOCAMENTO -- Piccole
parti. Non adatto a bambini sotto i 3 anni

OSTRZEŻENIE!
RYZYSKO ZADŁAWIENIA -- Małe części.
Niezgodnie dla dzieci poniżej 3 roku życia.

VAROITUS:
TUKETUUMISAARA --Pieniä osia.
Et alle 3-vuotiaallapsille

VARNING:
KVÄLVNINGSRISK -- Små delar.
Inlä avsett för barn under 3 år.

ADVARSEL:
KVELNINGSFÆRE -- Små deler. Ikke
till for barn under 3 år.

FORSIGTIG:
RISIKO FOR KVELNING-- Små
deler. Ikke egnet til børn under 3 år.

AVERTISSEMENT:
RISQUE D'ÉTOUFFEMENT -- Composé de petites
pièces. Ne convient pas aux enfants de moins de 3 ans.



Warning: CHOKING HAZARD -- Small parts. DO NOT put in nose or mouth.
Avertissement: RISQUE D'ASPHYXIE -- Ce produit contient de petits éléments. NE PAS mettre dans le nez ou la bouche
Advertencia: RIESGO DE ASFIXIA -- Contiene piezas pequeñas. NO lo meta en la nariz o la boca.
Achtung: ERSTICKTUNGSGEFÄHR -- Kleinteile. NICHT in die Nase oder den Mund geben.
Attenzione: RISCHIO DI SOFFOCAMENTO -- Pezzi piccoli. NON mettere nel naso o nella bocca.
Ostrzeżenie: RYZYSKO ZADŁAWIENIA -- Małe części. NIE WŁOŻOĆ do nosa ani do ust.
Varoitus: TUKETUUMISAARA -- Pieniä osia. ÄLÄ laittaa nenään tai suuhun.
Varning: KVÄLVNINGSRISK -- små delar. LÄGG INTE i näsa eller mun.
Advarsel: KVELNINGSFÆRE -- små deler. MÅ IKKE puttes i nese eller munn.
Advarsel: KVELNINGSFÆRE -- Små deler. Indsæt IKKE i næse eller mund.

HEXBUG®

VEX® ROBOTICS



HEXBUG.COM/VEX

i Excavator
406-7608
LOT #



VEX[®]

ROBOTICS

NEED HELP? / NECESITAS AYUDA? / BESOIN D'AIDE? / SERVE AIUTO?? /
HILFE? / POTRZEBUJESZ POMOCY? / TARVITSETKO APUA? / BEHÖVER DU HJÄLP? / TRENGER
DU HJELP? / BRUG FOR HJÆLP?

WWW.VEX.COM/HELP