



# IX20SE

SPECIAL EDITION INTELLIGENT RADIO

20-Channel 2.4GHz DSMX® Aircraft System

**QuickStart Guide**  
**Schnellstartanleitung**  
**Guide de Démarrage**  
**Guida Rapida**



## NOTICE

All instructions, warranties and other collateral documents are subject to change at the sole discretion of Horizon Hobby, LLC. For up-to-date product literature, visit [www.horizonhobby.com](http://www.horizonhobby.com) or [www.towerhobbies.com](http://www.towerhobbies.com) and click on the support or resources tab for this product.

## Meaning of Special Language

The following terms are used throughout the product literature to indicate various levels of potential harm when operating this product:

**WARNING:** Procedures, which if not properly followed, create the probability of property damage, collateral damage, and serious injury OR create a high probability of superficial injury.

**CAUTION:** Procedures, which if not properly followed, create the probability of physical property damage AND a possibility of serious injury.

**NOTICE:** Procedures, which if not properly followed, create a possibility of physical property damage AND a little or no possibility of injury.

 **WARNING:** Read the ENTIRE instruction manual to become familiar with the features of the product before operating. Failure to operate the product correctly can result in damage to the product, personal property and cause serious injury. This is a sophisticated hobby product. It must be operated with caution and common sense and requires some basic mechanical ability. Failure to operate this Product in a safe and responsible manner could result in injury or damage to the product or other property. This product is not intended for use by children without direct adult supervision. Do not attempt disassembly, use with incompatible components or alter product in any way without the approval of Horizon Hobby, LLC. This manual contains instructions for safety, operation and maintenance. It is essential to read and follow all the instructions and warnings in the manual, prior to assembly, setup or use, in order to operate correctly and avoid damage or serious injury.

**Age Recommendation: Not for children under 14. This is not a toy.**

**NOTICE:** This product is only intended for use with unmanned, hobby-grade, remote-controlled vehicles and aircraft. Horizon Hobby disclaims all liability outside of the intended purpose and will not provide warranty service related thereto.

## WARRANTY REGISTRATION

Visit [www.spektrumrc.com/registration](http://www.spektrumrc.com/registration) today to register your product.

## Safety Precautions

- Always ensure all batteries have been properly charged prior to using the model.
- Always check all servos and their connections prior to each run.
- Always engage throttle cut before approaching the model.
- Never operate your model near spectators, parking areas or any other area that could result in injury to people or damage of property.
- Never operate your model during adverse weather conditions. Poor visibility can cause disorientation and loss of control of your model.
- Never point the transmitter antenna directly toward the model. The radiation pattern from the tip of the antenna is inherently low.
- If at any time during the operation of your model you observe any erratic or abnormal operation, immediately stop operation of your model until the cause of the problem has been ascertained and corrected.

## Box Contents

- iX20 SE 20 Channel 2.4 GHz DSMX® Aircraft Transmitter (SPMR20110)
- 10500mAh 3.7V 1S Li-Ion Transmitter Battery Pack (SPMB10500LITX)
- Magnetic USB Charging Cable with Micro USB Magnetic Adapter
- iX20 SE Transmitter Case
- iX20 SE Neck Strap
- Gray Transmitter Grips
- Orange Transmitter Grips
- Orange Switch Nut Set With Wrench
- Screen Protector
- iX20 SE Decal Set

## Specifications

Channels	20
Model Memory	250
Programming Options	Airplane/Helicopter/ Sailplane/Multirotor
Modulation	DSM2/DSMX
Band	2.4GHz

Resolution	2048
Frame Rate	11/22 Ms
Modes	User Selectable Mode 1-4
Battery Type	Lithium Ion 10,500mAh
Charger Power Supply (not included)	2-3A minimum output

## Transmitter Functions

	Function
1	Antenna
2	LCD Touchscreen
3	Switch E2
4	Right Knob
5	Switch E
6	Right Top Trim
7	Switch H
8	Switch G
9	Switch F
10	Throttle Limit Adjustment (Mode 1,3)
11	Throttle Limit Screws
12	Rear Lever Tension Adjustment*
13	Mode Change Gimbal Centering Screw
14	Throttle/Aileron (Mode 1) Elevator/Aileron (Mode 2) Throttle/Rudder (Mode 3) Elevator/Rudder (Mode 4)
15	Up/Down Gimbal Stick Tension Adjustment*
16	Left/Right Gimbal Stick Tension Adjustment*

	Function
17	Aileron Trim (Mode 1,2) Rudder Trim (Mode 3,4)
18	Elevator Trim (Mode 2, 4) Throttle Trim (Mode 1, 3)
19	Neck Strap Mount
20	Switch D2
21	Switch I
22	Switch D
23	Left Top Trim
24	Switch A
25	Switch B
26	Switch C
27	Up/down Gimbal Stick Tension Adjustment*
28	Left/Right Gimbal Stick Tension Adjustment*
29	Elevator/Rudder (Mode 1) Throttle/Rudder (Mode 2) Elevator/Aileron (Mode 3) Throttle/Aileron (Mode 4)

	Function
30	Rudder Trim (Mode 1,2) Aileron Trim (Mode 3,4)
31	Throttle Limit Adjustment (Mode 2,4)
32	Elevator Trim (Mode 1,3) Throttle Trim (Mode 2,4)
33	Right Rear Lever
34	Camera Lens
35	Micro Memory Card Port
36	USB Charge Port
37	Battery Cover
38	Left Rear Lever
39	Serial Interface Port
40	Audio Jack
41	Left Trim
42	Power Button
43	LED
44	Right Trim

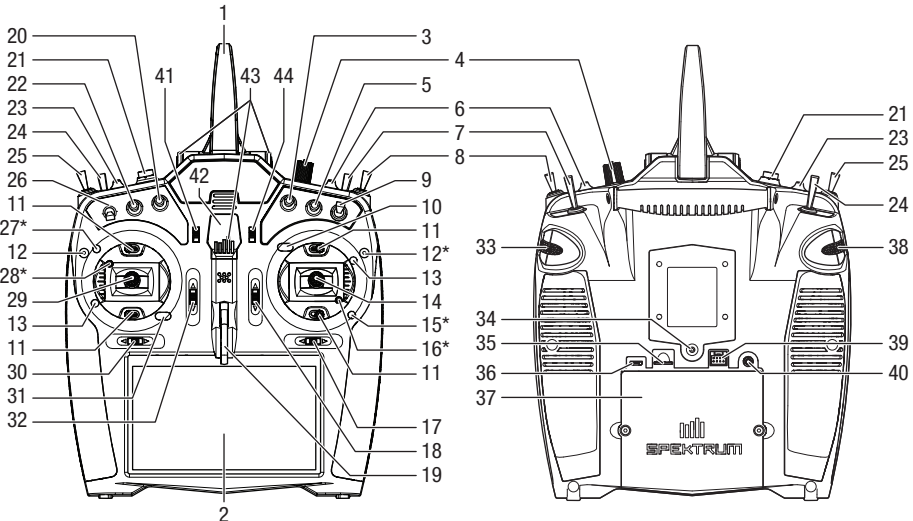

\* Do not over loosen the gimbal tension adjustment screws. Over loosening may cause the screws to fall out.

## Charging Warnings

- Failure to exercise caution while using this product and comply with the following warnings could result in product malfunction, electrical issues, excessive heat, FIRE, and ultimately injury and property damage.
- Read all safety precautions and literature prior to use of this product
- Never allow minors to charge battery packs
- Never drop charger or batteries
- Never attempt to charge damaged batteries
- Never attempt to charge a battery pack containing different types of batteries
- Never charge a battery if the cable has been pinched or shorted
- Never allow batteries or battery packs to come into contact with moisture at any time
- Never charge batteries in extremely hot or cold places (recommended between 50–80° F or 10–27° C) or place in direct sunlight
- Always disconnect the transmitter after charging, and let the charger cool between charges
- Always inspect a new battery before charging
- Always terminate all processes and contact Horizon Hobby if the product malfunctions
- Always keep batteries and charger away from any material that could be affected by heat (such as ceramic and tile), as they can get hot
- Always end the charging process if the charger or battery becomes hot to the touch or starts to change form (swell) during the charge process



## Charging

For optimum charging results, the built-in charger requires a USB power supply capable of at least 2-3A output. Using a power supply with a lower output will result in very long charge times or the transmitter not charging if it is powered on while attempting to charge.

The first time the transmitter is charged, the charge time may be 6-7 hours. Always charge the transmitter on a heat-resistant surface.

### Charging:

1. Connect a 2-3A USB power supply (not included) to an AC outlet.
2. Connect the included magnetic USB charging cable to the power supply.
3. Insert the included magnetic micro USB adapter in the USB port on the back of the transmitter.
4. Connect the USB charging cable to the magnetic adapter.
5. The LED will flash blue while charging. A fast press of the power switch will bring the Charge Battery icon to the color touch screen display.
6. Charging is complete when the button is pressed and the battery capacity icon on the screen shows full. Disconnect the USB cable once charging is complete. Disconnect the power supply from the power outlet. The magnetic micro USB adapter can be left in the transmitter USB port.

-  **CAUTION:** Never leave a charging battery unattended.
-  **CAUTION:** Never change the low voltage limit for Li-Ion batteries below 3.3V. Doing so could over-discharge the battery and damage both battery and transmitter.
-  **CAUTION:** Never charge the battery outside of the transmitter. Charging the battery outside of the transmitter may interfere with the battery monitoring system, which can give false low battery warnings.

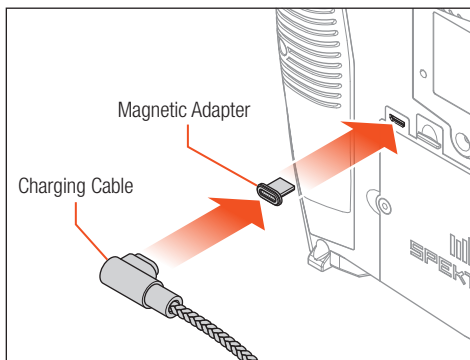

## Powering On/Off the iX20 Transmitter

The iX20 features a push button ON/OFF switch.

- To power on the transmitter, push and hold the power button for several seconds until the blue LED flashes and the LCD screen displays the start up screen. The orange LED indicator lights immediately, indicating the transmitter is sending an RF signal. Similar to other smart devices, startup takes ~30 seconds. Once startup is complete, the Spektrum Airware™ application will launch automatically, which requires another 15 seconds (approximately).
- To power off the transmitter, push and hold the power button for several seconds until the Power Off / Reboot prompt shows on the screen.
- Press "Power Off" to shutdown **OR** "Restart" to reboot the system.

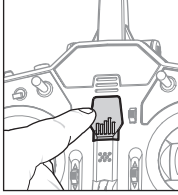

### TIPS:

- Press the power button once to put the display to sleep. The radio will continue to transmit normally while the screen is in sleep mode. Press the power button again to wake up the screen.
- Double pressing the power button will open a window allowing you to select RF On/Off, screen On/Off, WiFi On/Off, Bluetooth On/Off or Quick Sleep to put the system in sleep mode.
- It is recommended you use the sleep mode rather than powering the system off on flying days.
- The transmitter may be left in sleep mode for as long as 1-2 days safely. Power off the transmitter if you don't plan on using it within 2 days. Failing to power off the transmitter will result in continuous discharge of the battery.

## Navigation

The iX20 transmitter is built on the Android operating system and features a large color touch screen display. Navigate the iX20 using the same actions and gestures as those used to operate any other Android device.

To navigate, use your finger to tap, swipe and drag icons and menus found on the display.

**Long Press for OK:** When you see this icon, press and hold for approximately 2 seconds to accept the selection.



### Android Navigation

The Spektrum AirWare™ application will hide the Android home screen navigation icons.

To access the Android navigation icons at anytime, swipe up from the bottom edge of the screen. Press the circle icon to go to the Android home screen.

- ALL APPS:** Contains applications loaded onto the iX20.
- BACK:** Return to previous screen.
- HOME:** Return to the home screen.
- OVERVIEW:** Allows switching between and closing any of the running applications.

### Notification Screen

- Swipe down from the top of the screen once to exit full screen mode and bring the home screen navigation icons to the front.
- Swipe down a second time to roll down the Notification Screen for quick access to:
  - Settings
  - User Info
  - Brightness
  - Wi-Fi
  - Bluetooth
  - Landscape
  - Location
  - Cast Screen

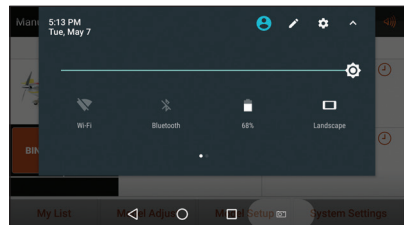
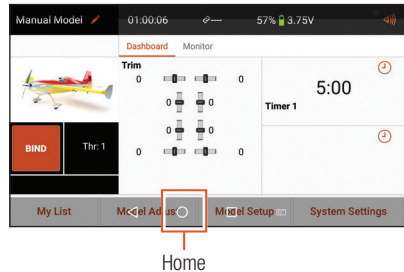

## Spektrum AirWare Navigation

The iX20 Spektrum AirWare app has up to four main screens that can be quickly accessed by swiping left or right on the touch screen display. The Dashboard and Monitor screens are always available. Telemetry Dashboard and Telemetry Min/Max are only available when telemetry information is present.

- **Dashboard:** The main screen displaying Trims, and Timers as well the model name and image.
- **Monitor:** Graphical representation of all control inputs.
- **Telemetry Dashboard\*:** Displays telemetry information for each sensor. User selects which items to display on this page from the Telemetry setup menu. Additional telemetry pages are available when activated in the telemetry setup menu.
- **Telemetry Min/Max\*:** Logs the minimum and maximum values collected from each telemetry sensor.

\*Only available if telemetry is active and the transmitter is bound to a telemetry receiver.



The Dashboard and the other main screens contain common information and navigation options to access various functions of the iX20 transmitter.

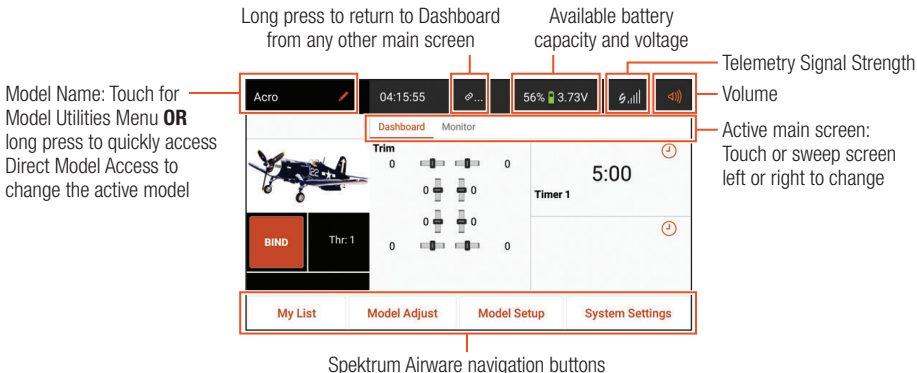

## Volume Control

- Touch the Volume icon (🔊) in the top right corner of any of the main screens to access the iX20 Volume menu.
- Move the slider up and down to adjust the volume.
- Touch the Mute button (🔇) to silence all sounds within the Spektrum AirWare app.

## Telemetry Reset

When the transmitter is bound to a telemetry receiver, telemetry signal strength bars appear in the main screen top bar (📶). Long press the strength bars to reset the telemetry flight data and erase the min/max data.

## Spektrum Airware Navigation Buttons

The Spektrum Airware navigation buttons are available from any of the main screens:

- My List
- Model Setup
- Model Adjust
- System Settings

To exit any of the above menus, press the back arrow (←) on the top left of the screen once to go back one menu or press and hold the back arrow to return directly to the dashboard.

### My List

My List allows the user to create a list of shortcuts to quickly navigate to the most used functions.

To create a shortcut list:

1. Touch the My List button on the main screen.
2. Touch the Configure button and select which functions to add to the My List. The functions will have a checkmark next to the name when selected.
3. Touch the Save button to save the list.

The selected functions are now available in the My List screen.

The My List button is configurable for each model and may be turned on or off from the Model Setup button, Menu Setup menu.

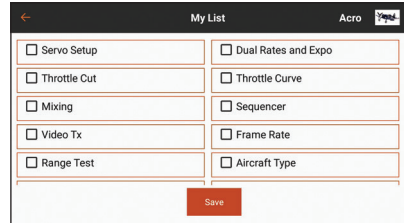
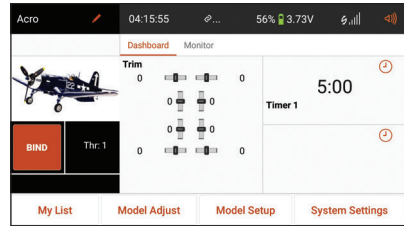

### Model Adjust

The Model Adjust menu contains features and adjustments that are used to finalize the settings for a model configuration. Options in the Model Adjust menu will vary depending on the model type selected during initial model configuration and the aircraft type selected in the Model Setup menu.

Some options include:

- Servo Setup
- Dual Rates/ Expo
- Throttle Cut
- Throttle Curve
- Mixing
- Flap System
- Sequencer

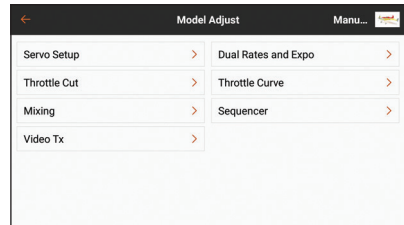

### Model Setup

The Model Setup menu options are used for basic aircraft setup configuration. The menu list varies by model type.

The Model Setup menu options include:

- Frame Rate
- Range Test
- Aircraft Type
- Timers
- Telemetry
- Trainer
- Audio Events
- Trim Setup
- Flight Mode Setup
- Channel Assign
- Analog Switch Setup
- Model Start Warnings
- Analog Switch Setup
- Digital Switch Setup
- Model Start Warnings
- Serial Port Setup
- Menu Setup
- Sleep Mode
- Bind
- Swash Type
- Sail Type
- Trim/Channel Config

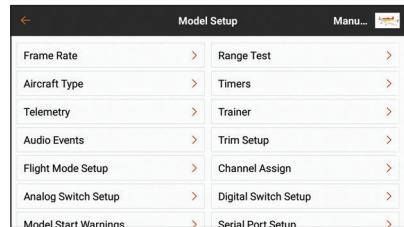

### System Settings

The System Settings menu options are used to make transmitter system adjustments and to access the manual.

The System Settings menu options include:

- System Configuration
- Product Information
- Calibration
- Manual
- Regulatory

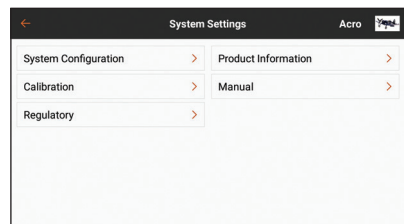

## Creating A New Model

1. Create a new model by touching the pen icon (✍) at the top left of the dashboard to access the **Model Utilities** screen. If RF is on, the system will open a dialog box to confirm RF will be turned off to enter this menu. Touch and hold **PROCEED** to continue.
2. Press on the expand icon (☰) at the top right corner of the **Model Utilities** screen.
3. Select **Add a New Model** from the drop down menu.
4. Select **Default**.
5. Select the model type desired from **Airplane**, **Helicopter**, **Sailplane** or **Multicopter**.
6. Select **Create**.
7. The model is added to the **Model Utilities** list and is now the active model, indicated by an orange outline.
8. Touch and hold the back arrow (←) to return to the dashboard.

**TIP:** Select the new model in the **Model Utilities** list to go to the **Model Details** page for that model to access these features:

- Change Model Name
- Change Model Image
- Monitor Channel Count
- Edit Model Type
- Reset Model Timer
- Duplicate Model
- Reset Model
- Delete Model
- Export Model
- Save As Template
- Model Note

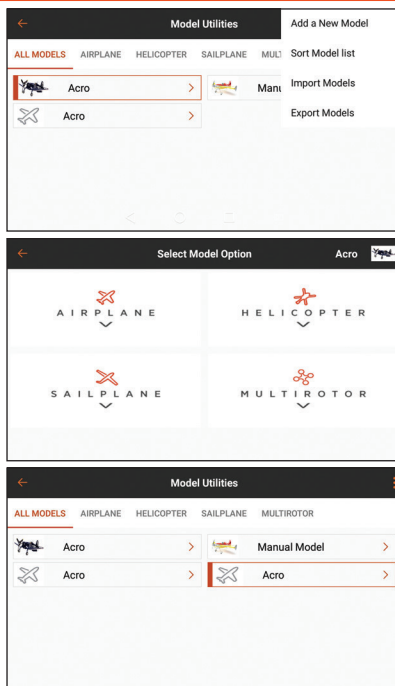

## Binding

Binding is the process of linking the iX20 transmitter to an aircraft receiver. The iX20 is compatible with genuine DSM2® and DSMX® Spektrum receiver products. The EU version of the iX20 does not support DSM2 receiver products.

Access the Bind menu from the Model Setup menu or access it directly by touching the **BIND** button on the Dashboard screen. Touch **Alerts** to configure any alerts which occur during binding.

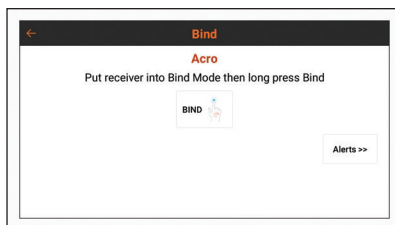

## FCC and ISED Information

The iX20 transmitter FCC and ISED regulatory information is available in the System Settings Menu.

1. Touch the **System Settings** button on any of the main screens.
2. Touch **Regulatory** to open.

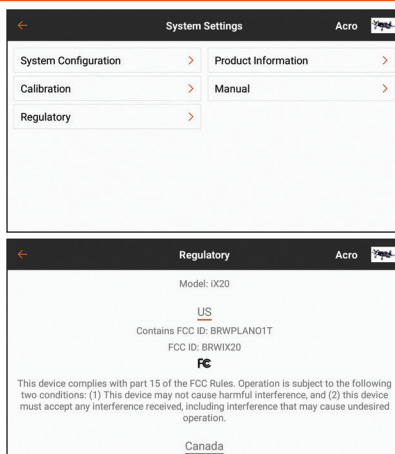



## Gimbal Adjustment Screws

The adjustment points for the iX20 are located around the face of each gimbal.\* This arrangement allows for quick and easy adjustment without removing the back cover.

The available adjustments include:

- Mode Change
- Throttle Ratchet
- Throttle Tension
- Stick Tension
- Rear Lever Tension

**NOTICE:** Always perform a stick tension test while turning the screws to ensure stick tension is not too loose or too tight. Overtightening a screw can damage the spring. Loosening a screw too far can cause a spring to fall out in the transmitter and possibly damage the circuitry within.

1	Centering
2	Ratchet Set
3	Tension Set
4	Vertical Spring Tension
5	Horizontal Spring Tension
6	Throttle Limit
7	Rear Lever Tension

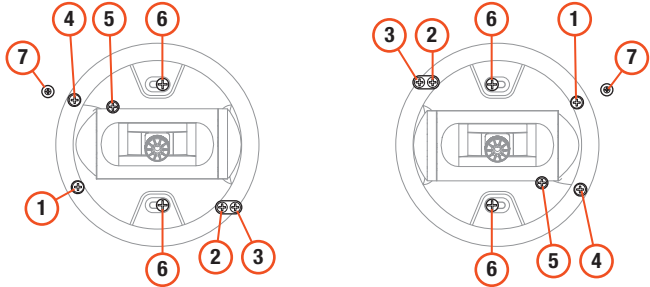

\*The gimbal adjustment screws are covered by small rubber plugs. Carefully remove these plugs prior to making adjustments. The plugs are not interchangeable. Ensure to note from where each plug is removed and replace them accordingly.

## Throttle Limit Adjustment For Transmitter Mode Change

Throttle limiting is used to limit the maximum travel of the throttle stick when changing between modes 1 and 2, or between modes 3 and 4.

1. To disengage the throttle limiting on the current throttle gimbal, turn both limit screws one half turn and slide them to the opposite side of the track.
2. Re-tighten the limit screws.
3. To engage the throttle limiting on the desired gimbal, turn both limit screws on the desired throttle gimbal one half turn and slide them to the opposite side of the track.
4. Re-tighten the limit screws.

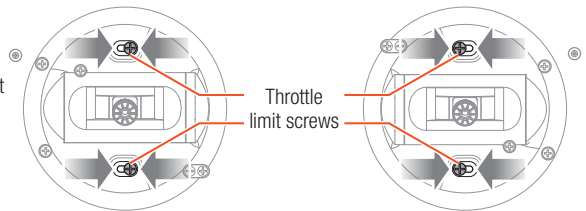

**IMPORTANT:** Do not remove the limit screws from the gimbals.

## 1-Year Limited Warranty

### What this Warranty Covers

Horizon Hobby, LLC, (Horizon) warrants to the original purchaser that the product purchased (the "Product") will be free from defects in materials and workmanship for a period of 1 years from the date of purchase.

### What is Not Covered

This warranty is not transferable and does not cover (i) cosmetic damage, (ii) damage due to acts of God, accident, misuse, abuse, negligence, commercial use, or due to improper use, installation, operation or maintenance, (iii) modification of or to any part of the Product, (iv) attempted service by anyone other than a Horizon Hobby authorized service center, (v) Product not purchased from an authorized Horizon dealer, (vi) Product not compliant with applicable technical regulations, or (vii) use that violates any applicable laws, rules, or regulations.

OTHER THAN THE EXPRESS WARRANTY ABOVE, HORIZON MAKES NO OTHER WARRANTY OR REPRESENTATION, AND HEREBY DISCLAIMS ANY AND ALL IMPLIED WARRANTIES, INCLUDING, WITHOUT LIMITATION, THE IMPLIED WARRANTIES OF NON-INFRINGEMENT, MERCHANTABILITY AND FITNESS FOR A PARTICULAR PURPOSE. THE PURCHASER ACKNOWLEDGES THAT THEY ALONE HAVE DETERMINED THAT THE PRODUCT WILL SUITABLY MEET THE REQUIREMENTS OF THE PURCHASER'S INTENDED USE.

### Purchaser's Remedy

Horizon's sole obligation and purchaser's sole and exclusive remedy shall be that Horizon will, at its option, either (i) service, (ii) repair, or (iii) replace, any Product determined by Horizon to be defective. Horizon reserves the right to inspect any and all Product(s) involved in a warranty claim. Service, service and/or replacement decisions are at the sole discretion of Horizon. Proof of purchase is required for all warranty claims. SERVICE, REPAIR OR REPLACEMENT AS PROVIDED UNDER THIS WARRANTY IS THE PURCHASER'S SOLE AND EXCLUSIVE REMEDY.

### Limitation of Liability

HORIZON SHALL NOT BE LIABLE FOR SPECIAL, INDIRECT, INCIDENTAL OR CONSEQUENTIAL DAMAGES, LOSS OF PROFITS OR PRODUCTION OR COMMERCIAL LOSS IN ANY WAY, REGARDLESS OF WHETHER SUCH CLAIM IS BASED IN CONTRACT, WARRANTY, TORT, NEGLIGENCE, STRICT LIABILITY OR ANY OTHER THEORY OF LIABILITY, EVEN IF HORIZON HAS BEEN ADVISED OF THE POSSIBILITY OF SUCH DAMAGES. Further, in no event shall the liability of Horizon exceed the individual price of the Product on which liability is asserted. As Horizon has no control over use, setup, final assembly, modification, use or misuse, no liability shall be assumed nor accepted for any resulting damage or injury. By the act of use, setup or assembly, the user accepts all resulting liability. If you as the purchaser or user are not prepared to accept the liability associated with the use of the Product, purchaser is advised to return the Product immediately in new and unused condition to the place of purchase.

### Law

These terms are governed by Illinois law (without regard to conflict of law principals). This warranty gives you specific legal rights, and you may also have other rights which vary from state to state. Horizon reserves the right to change or modify this warranty at any time without notice.

### WARRANTY SERVICES

#### Questions, Assistance, and Services

Your local hobby store and/or place of purchase cannot provide warranty support or service. Once assembly, setup or use of the Product has been started, you must contact your local distributor or Horizon directly. This will enable Horizon to

better answer your questions and service you in the event that you may need any assistance. For questions or assistance, please visit our website at [www.horizonhobby.com](http://www.horizonhobby.com), submit a Product Support Inquiry, or call the toll free telephone number referenced in the Warranty and Service Contact Information section to speak with a Product Support representative.

### Inspection or Services

If this Product needs to be inspected or serviced and is compliant in the country you live and use the Product in, please use the Horizon Online Service Request submission process found on our website or call Horizon to obtain a Return Merchandise Authorization (RMA) number. Pack the Product securely using a shipping carton. Please note that original boxes may be included, but are not designed to withstand the rigors of shipping without additional protection. Ship via a carrier that provides tracking and insurance for lost or damaged parcels, as Horizon is not responsible for merchandise until it arrives and is accepted at our facility. An Online Service Request is available at [http://www.horizonhobby.com/content/service-center\\_render-service-center](http://www.horizonhobby.com/content/service-center_render-service-center). If you do not have internet access, please contact Horizon Product Support to obtain a RMA number along with instructions for submitting your product for service. When calling Horizon, you will be asked to provide your complete name, street address, email address and phone number where you can be reached during business hours. When sending product to Horizon, please include your RMA number, a list of the included items, and a brief summary of the problem. A copy of your original sales receipt must be included for warranty consideration. Be sure your name, address, and RMA number are clearly written on the outside of the shipping carton.

**NOTICE:** Do not ship lithium batteries to Horizon. If you have any issue with a lithium battery, please contact the appropriate Horizon Product Support office.

### Warranty Requirements

**For Warranty consideration, you must include your original sales receipt verifying the proof-of-purchase date.** Provided warranty conditions have been met, your Product will be serviced or replaced free of charge. Service or replacement decisions are at the sole discretion of Horizon.

### Non-Warranty Service

**Should your service not be covered by warranty, service will be completed and payment will be required without notification or estimate of the expense unless the expense exceeds 50% of the retail purchase cost.** By submitting the item for service you are agreeing to payment of the service without notification. Service estimates are available upon request. You must include this request with your item submitted for service. Non-warranty service estimates will be billed a minimum of ½ hour of labor. In addition you will be billed for return freight. Horizon accepts money orders and cashier's checks, as well as Visa, MasterCard, American Express, and Discover cards. By submitting any item to Horizon for service, you are agreeing to Horizon's Terms and Conditions found on our website [http://www.horizonhobby.com/content/service-center\\_render-service-center](http://www.horizonhobby.com/content/service-center_render-service-center).

**ATTENTION:** Horizon service is limited to Product compliant in the country of use and ownership. If received, a non-compliant Product will not be serviced. Further, the sender will be responsible for arranging return shipment of the un-serviced Product, through a carrier of the sender's choice and at the sender's expense. Horizon will hold non-compliant Product for a period of 60 days from notification, after which it will be discarded without liability to Horizon.

## Warranty and Service Contact Information

Country of Purchase	Horizon Hobby	Phone Number/Email Address	Address
United States of America	Horizon Service Center (Repairs and Repair Requests)	servicecenter.horizonhobby.com/RequestForm/	2904 Research Rd Champaign, Illinois, 61822 USA
	Horizon Product Support (Product Technical Assistance)	productsupport@horizonhobby.com 877-504-0233	
	Sales	websales@horizonhobby.com 800-338-4639	
EU	Horizon Technischer Service Sales: Horizon Hobby GmbH	service@horizonhobby.de +49 (0) 4121 2655 100	Hanskampring 9 D 22885 Barsbüttel, Germany

## FCC Information

**Contains FCC ID: BRWPLAN01T**

**FCC ID: BRWIX20**

This equipment complies with FCC and IC radiation exposure limits set forth for an uncontrolled environment. This equipment should be installed and operated with minimum distance 20cm between the radiator and/or antenna and your body (excluding fingers, hands, wrists, ankles and feet). This transmitter must not be co-located or operating in conjunction with any other antenna or transmitter.

### Supplier's Declaration of Conformity

**Spektrum iX20SE Special Edition 20 Channel Aircraft Transmitter (SPMR20110);**

**FCC** This device complies with part 15 of the FCC Rules. Operation is subject to the following two conditions:  
(1) This device may not cause harmful interference, and (2) this device must accept any interference received, including interference that may cause undesired operation.



**CAUTION:** Changes or modifications not expressly approved by the party responsible for compliance could void the user's authority to operate the equipment.

**NOTE:** This equipment has been tested and found to comply with the limits for a Class B digital device, pursuant to part 15 of the FCC Rules. These limits are designed to provide

reasonable protection against harmful interference in a residential installation. This equipment generates, uses and can radiate radio frequency energy and, if not installed and used in accordance with the instructions, may cause harmful interference to radio communications. However, there is no guarantee that interference will not occur in a particular installation. If this equipment does cause harmful interference to radio or television reception, which can be determined by turning the equipment off and on, the user is encouraged to try to correct the interference by one or more of the following measures:

- Reorient or relocate the receiving antenna.
- Increase the separation between the equipment and receiver.
- Connect the equipment into an outlet on a circuit different from that to which the receiver is connected.
- Consult the dealer or an experienced radio/TV technician for help.

Horizon Hobby, LLC  
2904 Research Road,  
Champaign, IL 61822  
Email: compliance@horizonhobby.com  
Web: HorizonHobby.com

## IC Information

**Contains IC: 6157A-PLAN01T**

**IC: 6157A-IX20**

**CAN ICES-3 (B)/NMB-3(B)**

This device contains license-exempt transmitter(s)/ receiver(s) that comply with Innovation, Science, and Economic Development Canada's license-exempt RSS(s). Operation is subject to the following 2 conditions:

1. This device may not cause interference.
2. This device must accept any interference, including interference that may cause undesired operation of the device.

## Compliance Information for the European Union



### EU Compliance Statement:

#### Spektrum iX20SE Special Edition 20 Channel Aircraft Transmitter (SPMR20110);

Hereby, Horizon Hobby, LLC declares that the device is in compliance with the following: EU Radio Equipment Directive 2014/53/EU; RoHS 2 Directive 2011/65/EU; RoHS 3 Directive - Amending 2011/65/EU Annex II 2015/863.

The full text of the EU declaration of conformity is available at the following internet address: <http://www.horizonhobby.com/content/support-render-compliance>.

**NOTE:** This product contains batteries that are covered under the 2006/66/EC European Directive, which cannot be disposed of with normal household waste. Please follow local regulations.

### Wireless Frequency Range and Wireless Output Power Control:

Frequency Band: 2402-2478MHz  
Max EIRP: 20 dBm

### Trainer:

Frequency Band: 2404-2478MHz  
Max EIRP: 3 dBm

### 2.4 GHz WiFi:

Frequency Band: 2412-2462MHz  
Max EIRP: 19.5 dBm

### 5GHz WiFi:

Frequency Band: 4900-5845MHz  
Max EIRP: 15.5 dBm

### Bluetooth:

Frequency Band: 2404-2480MHz  
Max EIRP: 10 dBm

### EU Manufacturer of Record:

Horizon Hobby, LLC  
2904 Research Road  
Champaign, IL 61822 USA

### EU Importer of Record:

Horizon Hobby, GmbH  
Hanskampring 9  
22885 Barsbüttel Germany

### WEEE NOTICE:



This appliance is labeled in accordance with European Directive 2012/19/EU concerning waste of electrical and electronic equipment (WEEE). This label indicates that this product should not be disposed of with household waste.

It should be deposited at an appropriate facility to enable recovery and recycling.



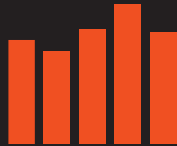

# SPEKTRUM®

© 2020 Horizon Hobby, LLC.

DSMX, the DSMX logo, Spektrum AirWare and the Horizon Hobby logo are trademarks or registered trademarks of Horizon Hobby, LLC.

The Spektrum trademark is used with permission of Bachmann Industries, Inc. Android is a trademark of Google Inc.

The Bluetooth® word mark and logos are registered trademarks owned by Bluetooth SIG, Inc. and any use of such marks by Horizon Hobby is under license.

The WiFi logo is a registered trademark of WiFi Alliance.

All other trademarks, service marks and logos are property of their respective owners. US 9,930,567. US 10,419,970.

Created 11/20

SPMR20110

64351