

**SPEKTRUM®**

**Spektrum DXS and AR410 4 CH Receiver**

---

**Spektrum DXS und AR410-Empfänger mit 4 Kanälen**

---

**Spektrum DXS et récepteur AR410 4 canaux**

---

**Spektrum DXS e ricevitore AR410 a 4 canali**

---

**NOTICE**

All instructions, warranties and other collateral documents are subject to change at the sole discretion of Horizon Hobby, LLC. For up-to-date product literature, visit [horizonhobby.com](http://horizonhobby.com) or [towerhobbies.com](http://towerhobbies.com) and click on the support or resources tab for this product.

**Meaning of Special Language**

The following terms are used throughout the product literature to indicate various levels of potential harm when operating this product:

**WARNING:** Procedures, which if not properly followed, create the probability of property damage, collateral damage, and serious injury OR create a high probability of superficial injury.

**CAUTION:** Procedures, which if not properly followed, create the probability of physical property damage AND a possibility of serious injury.

**NOTICE:** Procedures, which if not properly followed, create a possibility of physical property damage AND a little or no possibility of injury.



**WARNING:** Read the ENTIRE instruction manual to become familiar with the features of the product before operating. Failure to operate the product correctly can result in damage to the product, personal property and cause serious injury.

This is a sophisticated hobby product. It must be operated with caution and common sense and requires some basic mechanical ability. Failure to operate this Product in a safe and responsible manner could result in injury or damage to the product or other property. This product is not intended for use by children without direct adult supervision. Do not attempt disassembly, use with incompatible components or alter product in any way without the approval of Horizon Hobby, LLC. This manual contains instructions for safety, operation and maintenance. It is essential to read and follow all the instructions and warnings in the manual, prior to assembly, setup or use, in order to operate correctly and avoid damage or serious injury.

**Age Recommendation: Not for children under 14 years. This is not a toy.**

**WARNING AGAINST COUNTERFEIT PRODUCTS**

Always purchase from a Horizon Hobby, LLC authorized dealer to ensure authentic high-quality Spektrum product. Horizon Hobby, LLC disclaims all support and warranty with regards, but not limited to, compatibility and performance of counterfeit products or products claiming compatibility with DSM or Spektrum technology.

**NOTICE:** This product is only intended for use with unmanned, hobby-grade, remote-controlled vehicles and aircraft. Horizon Hobby disclaims all liability outside of the intended purpose and will not provide warranty service related thereto.

**WARRANTY REGISTRATION**

Visit [www.spektrumrc.com/registration](http://www.spektrumrc.com/registration) today to register your product.

## Spektrum DXS Transmitter and AR410 Receiver

The Spektrum™ DSMX® DXS 7-Channel transmitter is available either as the transmitter only (SPMR1010), or packaged with a full range Spektrum AR410 4-Channel receiver (SPM1010). The DXS transmitter and AR410 receiver are each fully compatible with other Spektrum DSMX systems.

The DXS transmitter has a default configuration that is designed to work with SAFE® technology; a 3-position switch for Flight Modes on Channel 5, and a momentary switch on Channel 6 to trigger Panic Mode.

### Contents

Spektrum DXS Transmitter and AR410 Receiver .....	3
Specifications .....	4
Transmitter Diagram .....	5
Installing the Transmitter Batteries .....	6
Turning the Transmitter ON and OFF .....	6
Receiver Diagram .....	6
Receiver Installation .....	6
Binding .....	7
Transmitter Setup .....	7
Setting Failsafe On The AR410 Receiver .....	9
Smart Telemetry and LED Indicators on the DXS .....	9
LED Smart Battery Usage .....	10
Wireless Trainer .....	10
Range Test .....	10
Adjust Stick Tension .....	11
Changing the Throttle Ratchet .....	11
1-Year Limited Warranty .....	13
Warranty and Service Contact Information .....	14
Compliance Information for United States .....	15
Compliance Information for Canada .....	16
Compliance Information for the European Union .....	16

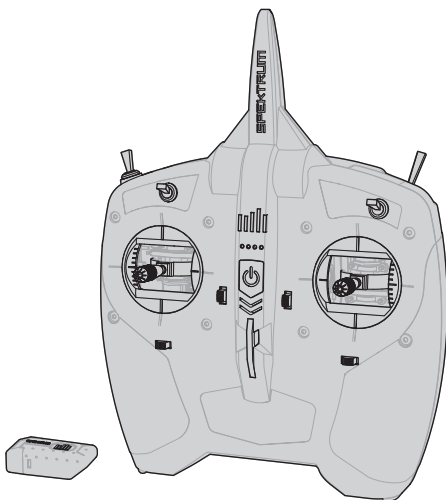

## Specifications

<b>SPMR1010</b>	<b>DXS TRANSMITTER</b>
Type	DSMX 7 CH Transmitter
Auxiliary Switches and Buttons	1 Momentary Button, 2 3-Position Switch, 2 2-Position Switches
Channels	7
Power Supply	4 AA Batteries
Control Mode	Mode 2
Telemetry	Flight Battery Voltage (Smart ESC required)
Trainer	Wireless; Remote Receiver SPM9747 Required Compatible with DSM2 or DSMX transmitters
Data Port	Serial adapter (SPMA3068) included for connection with the USB Programming Cable (SPMA3065, not included)
Frequency	2.4GHz
Trim Programming	Servo Reversing

<b>SPMAR410</b>	<b>AR410 RECEIVER</b>
Type	DSMX 4-Channel Sport Receiver
Dimensions (L × W × H)	45.2 × 20.0 × 13.9mm
Antenna Length	Internal
Channels	4; Throttle Port Smart Compatible
Weight	7g
Frequency	2.4GHz
Voltage Range	3.5–9V

## Transmitter Diagram

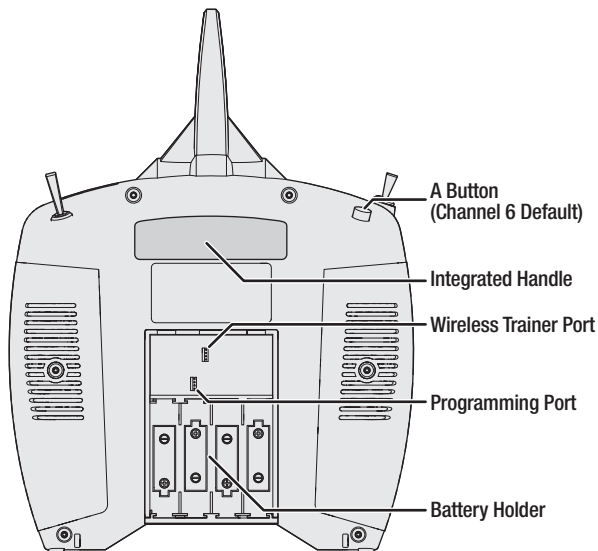
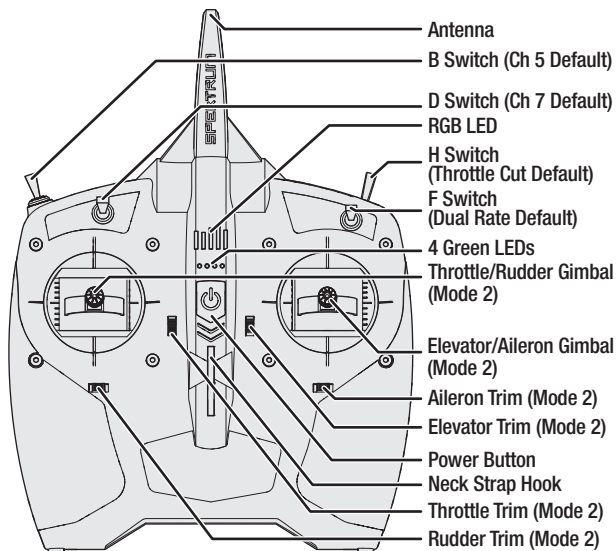

## Installing the Transmitter Batteries

1. Remove the battery cover from the bottom of the transmitter.
2. Install four AA batteries as shown.
3. Install the battery cover.



**CAUTION:** NEVER remove the transmitter batteries while the model is powered on. Loss of model control, damage or injury may occur.



**CAUTION:** If using rechargeable batteries, charge only rechargeable batteries. Charging non-rechargeable batteries may cause the batteries to burst, resulting in injury to persons and/or damage to property.



**CAUTION:** Risk of explosion if battery is replaced by an incorrect type. Dispose of used batteries according to national regulations.

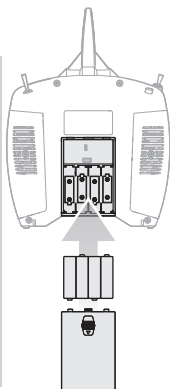

## Turning the Transmitter ON and OFF

Press and hold the power button to power the transmitter ON. The RGB LED indicator will illuminate Orange when the transmitter is ON and transmitting. To power the transmitter OFF, press and hold the power button for 5 seconds.

## Receiver Diagram

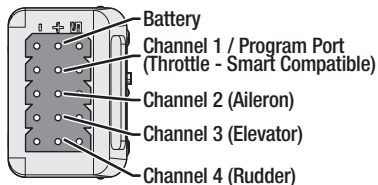

Bind Button

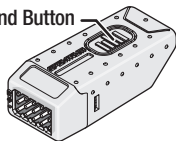

**IMPORTANT:** When using Y-harness or servo extensions with Spektrum equipment, do not use reversing harnesses. Using reversing Y-harnesses or servo extensions may cause servos to operate erratically or not function at all.

## Receiver Installation

Install the receiver as recommended by your airplane's manufacturer and connect the servos to their respective ports. Double-sided tape or foam can be used to secure the receiver in place. The AR410 features an internal antenna design for easy installation in almost any model.

Most ESCs include a circuit (called a BEC) to power the receiver through the throttle connection. If you do not have a BEC powering the receiver, connect your 3.5 to 9 volt power supply (battery or dedicated regulator) to the battery port to power the receiver. The receiver will power ON when power is connected.

## Binding

The DXS and your receiver must be bound to each other before they will operate. Binding is the process of teaching the receiver the specific code of the transmitter so it will only connect to that specific transmitter.

1. Push and hold the bind button on the receiver while powering ON the receiver. Release the bind button once the orange LED starts to flash continuously, indicating that the receiver is in bind mode. The AR410 receiver will also enter bind mode if you power ON the receiver and then press the bind button before the receiver has connected to any transmitter.
2. With the throttle in the low position, push and hold the A button while turning the transmitter ON to put the transmitter in bind mode.
3. After you set up your model, always rebind the transmitter and receiver to set the desired failsafe positions.

BIND Status	DXS and AR410
Ready to Bind	Flashing Orange LED
Bind Complete	Solid Orange LED

## Transmitter Setup

The DXS transmitter has reversible channels with trim programming.

Trim programming is a special setup mode on the DXS transmitter. You can only enter trim programming at power up. The DXS transmitter does not emit a signal to the receiver during trim programming to prevent accidental operation. Normal control operation will not resume until you power the transmitter OFF and then back ON again normally.

### Trim Programming

1. Confirm the channel numbers that need to be reversed.
2. Power OFF the DXS transmitter and the receiver. Leave the aircraft powered OFF during trim programming.
3. To enter trim programming mode, push and hold the elevator and throttle trim buttons up awhile you power ON the DXS transmitter.

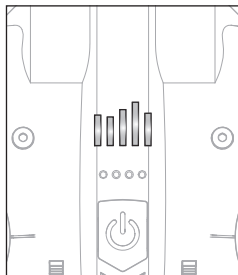
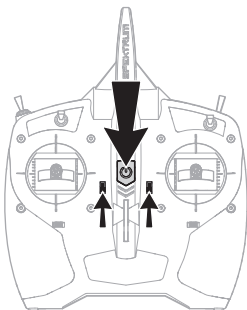

The RGB LED on the transmitter will illuminate green to indicate the transmitter is in trim programming mode.

4. The flashing green LED corresponds to the selected channel. When the first LED is flashing, the throttle channel is selected (Channel 1).

During trim programming, the four green LEDs on the transmitter will flash to indicate which channel is selected for reversing

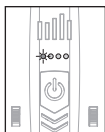

Channel 1  
Throttle\*

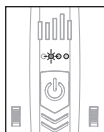

Channel 2  
Aileron

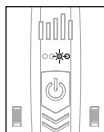

Channel 3  
Elevator

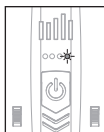

Channel 4  
Rudder

To reverse the selected channel, press the right vertical trim up (Elevator trim for Mode 2). If you don't want to reverse the selected channel, proceed to confirming the direction.

The RGB LED indicates servo direction; green for normal, red for reverse

To confirm the direction for the selected channel, press and hold the A button. The setting will be saved and the next channel will be selected. Repeat the process through the first four channels.

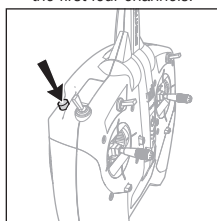
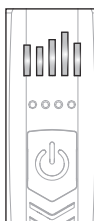
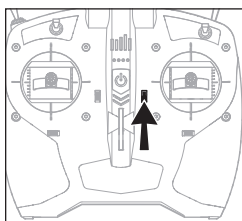

5. Once the first four channels have been confirmed, the LEDs will indicate channels 5 through 7. Reverse channels as necessary and confirm the setting with the same process as the previous step.
6. After the last channel is confirmed, power the transmitter OFF to save the settings and exit trim programming. After confirming all 7 channels with button A, the system will automatically shut off.

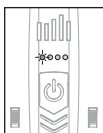

Channel 5

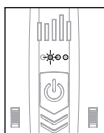

Channel 6

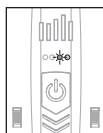

Channel 7

**\*Throttle Reversed Warning:** The transmitter will emit a warning tone and display flashing LEDs upon reversing the throttle, after powering the transmitter OFF and back ON. Press and hold the bind button/ switch A to accept and clear the throttle reversed warning.

**Factory Reset:** Power the transmitter on while holding the sticks down and outward. The transmitter will emit a series of beeps and revert to factory settings.

**IMPORTANT:** Factory reset will restore all settings to factory default, losing any settings programmed in the DXS.



## Setting Failsafe On The AR410 Receiver

The method of Failsafe and the Failsafe positions are set in the receiver during binding. In the unlikely event that the radio link is lost during use, the receiver will move all servo output signals to their pre-programmed failsafe positions. If the power supply to the receiver drops below 3.5 volts during use, the receiver will be unable to operate until the voltage recovers, and failsafe will not work. That event would be called a brownout, and must be resolved in the power supply to the receiver (BEC in the ESC, regulator, receiver battery, etc).

The AR410 Receiver may be set to either SmartSafe or Preset failsafe, as described below.

### SmartSafe + Hold Last

If loss of signal occurs, SmartSafe™ technology moves the throttle channel to its preset failsafe position (low throttle) that was set during binding. All other channels hold their last position. When the receiver detects signal from the transmitter, normal aircraft operation resumes.

### Preset Failsafe

Preset failsafe is ideal for sailplanes, allowing the aircraft to automatically dethermalize if the signal is lost. With preset failsafe, all channels go to their preset failsafe positions if the signal is lost, preventing a flyaway. When the receiver detects signal from the transmitter, normal aircraft operation resumes.

### SmartSafe + Hold Last

1	Lower the throttle on the transmitter
2	Push and hold the bind button on the AR410 and then power it ON
3	Release the button once the LED begins to flash
4	Press the A button on the transmitter and power it ON.

### Preset Failsafe

1	Move all sticks and switches on the DXS to the desired failsafe positions
2	Push and hold the bind button on the AR410 and then power it ON
3	Release the button once the LED begins to flash
4	Push and Hold the Bind Button on the receiver during the rest of the bind process.
5	Press the A button on the transmitter and power it ON.

## Smart Telemetry and LED Indicators on the DXS

**Aircraft Battery Voltage:** The four green LEDs on the DXS transmitter show the aircraft battery voltage when using a Smart telemetry.

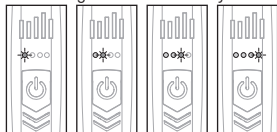

When paired with a Spektrum Smart ESC and compatible receiver, the aircraft battery voltage will be displayed on the DXS transmitter's four LEDs. When in normal operation with a Smart ESC, one LED will illuminate for a low battery, two for a half charged battery, three for a battery between half and full, and four for a fully charged flight battery.

**IMPORTANT:** The four Green LEDs on the transmitter do not indicate the battery voltage of the AA batteries. The DXS transmitter only indicates the voltage of the AA batteries if they are low and need to be replaced.

**Low Battery Alarm:** The DXS transmitter will emit a repeating warning tone and the RGB LED will flash red if the AA batteries are below approximately 4.7V.

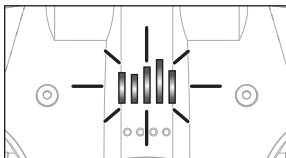

## LED Smart Battery Usage

LED Smart Battery voltage indication is based on current voltage and will change with throttle/power usage. When throttle is increased, voltage drops, causing the bars to indicate lower power (e.g., fewer LEDs solid or flashing.) When the throttle is lowered to idle/off, the bars recover (e.g., more LEDs solid or flashing). LED bars will rise and lower depending on throttle/power usage.

The Smart Battery low voltage alarm sounds when the ESCs are close to reaching low voltage cutoff. The alarm will sound for 25 seconds. If the throttle is lowered to allow voltage recovery, the alarm will stop early.

Land the aircraft when the alarm sounds.

After landing, reset the Smart Battery low voltage warning by either (1) powering cycling the DXS transmitter, or (2) disconnecting the battery from the aircraft for more than 15 seconds or until the LED voltage indication bars go out.

Connect a fully charged battery to the aircraft, which will ensure the Smart Battery low voltage warning resets prior to the next flight.

## Wireless Trainer

The DXS transmitter is capable of operating as the Instructor transmitter for a training situation. A remote receiver (SPM9747 optional, not included) is required to add this function. When a student transmitter is bound to the (optional) remote receiver inside the DXS, pressing and holding the A button gives the student control.

### Remote Receiver Installation:

1. Open the battery door
2. Connect the remote receiver cable to the wireless trainer port.
3. Install the remote receiver in the cavity behind the battery door with double sided tape.

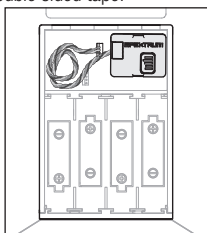

### Binding the Student Transmitter:

1. Press and hold the bind button on the remote receiver.
2. Power the DXS ON, the orange LED on the remote receiver will flash indicating it is in bind mode. Release the bind button.

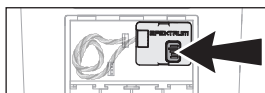

3. Put the student transmitter into Bind mode. The orange LED on the remote receiver will remain lit when it is bound to the student transmitter.
4. Replace the battery door after binding the student transmitter.

## Range Test

1. Power on the transmitter for at least five seconds with the throttle stick and trim low.
2. Press and hold switch A (Bind button) and toggle switch F four times within 10 seconds. The transmitter LEDs will flash orange and the alarm will sound. The system is in range check mode. Do not let go of the bind button until you are finished with the range check.

**IMPORTANT:** You must hold the BIND/Panic button during the entire range check process. Releasing the button will exit the range check mode.

## Changing the Throttle Ratchet

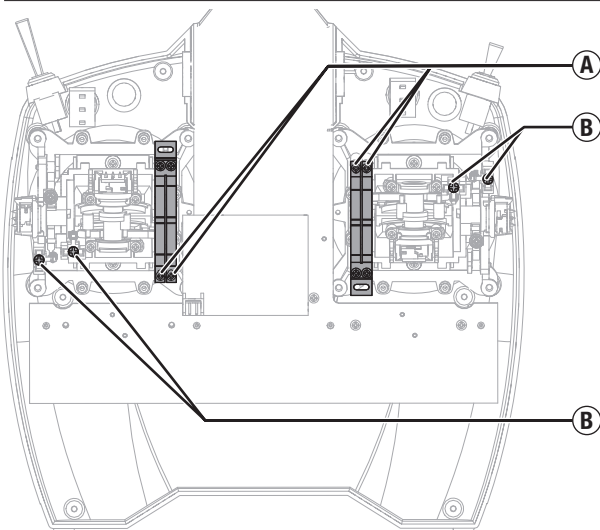

1. Remove the batteries from the transmitter.
2. Remove the six Phillips head screws that secure the rear transmitter case half.
3. Put the transmitter face down on a piece of foam or a towel and remove the rear case.

**NOTICE:** Do not pull or disconnect any of the wires attached to the back transmitter half or damage may result.

4. Locate the silver throttle friction straps **(A)** on both gimbals. One strap engages a serrated section on the gimbal for a ratcheted throttle, while the other strap engages the smooth section on the gimbal.
5. To change the throttle ratchet, loosen the throttle strap so it does not touch the throttle gimbal. Tighten the opposite throttle strap to engage the desired throttle ratchet.

## Adjust Stick Tension

1. Disconnect the battery holder or optional battery from the transmitter and set aside.
2. Remove the six Phillips head screws that secure the rear transmitter case half.
3. Put the transmitter face down on a piece of foam or a towel and remove the rear case.
4. Tighten or loosen the screws **(B)** a small amount using a small Phillips screwdriver.

**NOTICE:** Always do a test of stick tension while turning these screws to ensure stick tension is not too loose or too tight. Tightening a screw too much can damage a spring. Loosening a screw too much can let a spring fall off and cause short-circuit in the transmitter.



**CAUTION:** Always power off the transmitter, disconnect and remove the battery before adjusting stick tension or friction straps. Not doing so could result in property damage or injury.

## Troubleshooting Guide

Problem	Possible Cause	Solution
Aircraft will not respond to throttle but responds to other controls	Throttle not at idle and/or throttle trim too high	Reset controls with throttle stick and throttle trim at lowest setting
	Throttle servo travel is lower than 100%	Make sure throttle servo travel is 100% or greater
	Throttle channel is reversed	(With battery disconnected from aircraft) Reverse throttle channel on transmitter
	Motor disconnected from ESC	Make sure motor is connected to the ESC
Aircraft will not Bind (during binding) to transmitter	Transmitter too near aircraft during binding process	Move powered transmitter a few feet from aircraft, disconnect and reconnect flight battery to aircraft
	Aircraft or transmitter is too close to large metal object, wireless source or another transmitter	Move aircraft and transmitter to another location and attempt binding again
	The bind plug is not installed correctly in the bind port	Install bind plug in bind port and bind the aircraft to the transmitter
	Flight battery/transmitter battery charge is too low	Replace/recharge batteries
	Bind button not held long enough during bind process	Power off and repeat bind process.
Aircraft will not connect (after binding) to transmitter	Transmitter too near aircraft during connecting process	Move powered transmitter a few feet from aircraft, disconnect and reconnect flight battery to aircraft
	Aircraft or transmitter is too close to large metal object, wireless source or another transmitter	Move aircraft and transmitter to another location and attempt connecting again
	Bind plug left installed in bind port	Rebind transmitter to the aircraft and remove the bind plug before cycling power
	Aircraft bound to different model memory.	Select correct model memory on transmitter
	Flight battery/Transmitter battery charge is too low	Replace/recharge batteries
	Transmitter may have been bound to a different aircraft using different DSM protocol	Rebind aircraft to transmitter
Control surface does not move	Control surface, control horn, linkage or servo damage	Replace or repair damaged parts and adjust controls
	Wire damaged or connections loose	Perform a check of wires and connections, connect or replace as needed
	Transmitter is not bound correctly or the incorrect model was selected	Rebind or select correct airplanes in transmitter
	Flight battery charge is low	Fully recharge flight battery
	BEC (Battery Elimination Circuit) of the ESC is damaged	Replace ESC

## 1-Year Limited Warranty

**What this Warranty Covers** - Horizon Hobby, LLC, (Horizon) warrants to the original purchaser that the product purchased (the "Product") will be free from defects in materials and workmanship for a period of 1 year from the date of purchase.

**What is Not Covered** - This warranty is not transferable and does not cover (i) cosmetic damage, (ii) damage due to acts of God, accident, misuse, abuse, negligence, commercial use, or due to improper use, installation, operation or maintenance, (iii) modification of or to any part of the Product, (iv) attempted service by anyone other than a Horizon Hobby authorized service center, (v) Product not purchased from an authorized Horizon dealer, (vi) Product not compliant with applicable technical regulations, or (vii) use that violates any applicable laws, rules, or regulations. OTHER THAN THE EXPRESS WARRANTY ABOVE, HORIZON MAKES NO OTHER WARRANTY OR REPRESENTATION, AND HEREBY DISCLAIMS ANY AND ALL IMPLIED WARRANTIES, INCLUDING, WITHOUT LIMITATION, THE IMPLIED WARRANTIES OF NON-INFRINGEMENT, MERCHANTABILITY AND FITNESS FOR A PARTICULAR PURPOSE. THE PURCHASER ACKNOWLEDGES THAT THEY ALONE HAVE DETERMINED THAT THE PRODUCT WILL SUITABLY MEET THE REQUIREMENTS OF THE PURCHASER'S INTENDED USE.

**Purchaser's Remedy** - Horizon's sole obligation and purchaser's sole and exclusive remedy shall be that Horizon will, at its option, either (i) service, or (ii) replace, any Product determined by Horizon to be defective. Horizon reserves the right to inspect any and all Product(s) involved in a warranty claim. Service or replacement decisions are at the sole discretion of Horizon. Proof of purchase is required for all warranty claims. SERVICE OR REPLACEMENT AS PROVIDED UNDER THIS WARRANTY IS THE PURCHASER'S SOLE AND EXCLUSIVE REMEDY.

**Limitation of Liability** - HORIZON SHALL NOT BE LIABLE FOR SPECIAL, INDIRECT, INCIDENTAL OR CONSEQUENTIAL DAMAGES, LOSS OF PROFITS OR PRODUCTION OR COMMERCIAL LOSS IN ANY WAY, REGARDLESS OF WHETHER SUCH CLAIM IS BASED IN CONTRACT, WARRANTY, TORT, NEGLIGENCE, STRICT LIABILITY OR ANY OTHER THEORY OF LIABILITY, EVEN IF HORIZON HAS BEEN ADVISED OF THE POSSIBILITY OF SUCH DAMAGES. Further, in no event shall the liability of Horizon exceed the individual price of the Product on which liability is asserted. As Horizon has no control over use, setup, final assembly, modification or misuse, no liability shall be assumed nor accepted for any resulting damage or injury. By the act of use, setup or assembly, the user accepts all resulting liability. If you as the purchaser or user are not prepared to accept the liability associated with the use of the Product, purchaser is advised to return the Product immediately in new and unused condition to the place of purchase.

**Law** - These terms are governed by Illinois law (without regard to conflict of law principals). This warranty gives you specific legal rights, and you may also have other rights which vary from state to state. Horizon reserves the right to change or modify this warranty at any time without notice.

### WARRANTY SERVICES

**Questions, Assistance, and Services** - Your local hobby store and/or place of purchase cannot provide warranty support or service. Once assembly, setup or use of the Product has been started, you must contact your local distributor or Horizon directly. This will enable Horizon to better answer your questions and service you in the event that you may need any assistance. For questions or assistance, please visit our website at [www.horizonhobby.com](http://www.horizonhobby.com), submit a Product Support Inquiry at <https://horizonhobby.quickbase.com/db/bghj7ey8c?a=GenNewRecord>, or call the toll free telephone number referenced in the Warranty and Service Contact Information section to speak with a Product Support representative.

**Inspection or Services** - If this Product needs to be inspected or serviced and is compliant in the country you live and use the Product in, please use the Horizon Online Service Request submission process found on our website or call Horizon to obtain a Return Merchandise Authorization (RMA) number. Pack the Product securely using a shipping carton. Please note that original boxes may

be included, but are not designed to withstand the rigors of shipping without additional protection. Ship via a carrier that provides tracking and insurance for lost or damaged parcels, as Horizon is not responsible for merchandise until it arrives and is accepted at our facility. An Online Service Request is available at [http://www.horizonhobby.com/content/\\_service-center\\_render-service-center](http://www.horizonhobby.com/content/_service-center_render-service-center). If you do not have internet access, please contact Horizon Product Support to obtain a RMA number along with instructions for submitting your product for service. When calling Horizon, you will be asked to provide your complete name, street address, email address and phone number where you can be reached during business hours. When sending product into Horizon, please include your RMA number, a list of the included items, and a brief summary of the problem. A copy of your original sales receipt must be included for warranty consideration. Be sure your name, address, and RMA number are clearly written on the outside of the shipping carton. Provided warranty conditions have been met, your Product will be serviced or replaced free of charge. Service or replacement decisions are at the sole discretion of Horizon.

**NOTICE: Do not ship LiPo batteries to Horizon. If you have any issue with a LiPo battery, please contact the appropriate Horizon Product Support office. Warranty Requirements - For Warranty consideration, you must include your original sales receipt verifying the proof-of-purchase date.**

**Non-Warranty Service** - Should your service not be covered by warranty, service will be completed and payment will be required without notification or estimate of the expense unless the expense exceeds 50% of the retail purchase cost. By submitting the item for service you are agreeing to payment of the service without notification. Service estimates are available upon request. You must include this request with your item submitted for service. Non-warranty service estimates will be billed a minimum of ½ hour of labor. In addition you will be billed for return freight. Horizon accepts money orders and cashier's checks, as well as Visa, MasterCard, American Express, and Discover cards. By submitting any item to Horizon for service, you are agreeing to Horizon's Terms and Conditions found on our website [http://www.horizonhobby.com/content/\\_service-center\\_render-service-center](http://www.horizonhobby.com/content/_service-center_render-service-center).

**ATTENTION: Horizon service is limited to Product compliant in the country of use and ownership. If received, a non-compliant Product will not be serviced. Further, the sender will be responsible for arranging return shipment of the un-serviced Product, through a carrier of the sender's choice and at the sender's expense. Horizon will hold non-compliant Product for a period of 60 days from notification, after which it will be discarded.**

10/15

## Warranty and Service Contact Information

Country of Purchase	Horizon Hobby	Contact Information	Address
United States of America	Horizon Service Center (Repairs and Repair Requests)	<a href="http://servicecenter.horizonhobby.com/RequestForm/">servicecenter.horizonhobby.com/RequestForm/</a>	2904 Research Rd. Champaign, Illinois, 61822 USA
	Horizon Product Support (Product Technical Assistance)	<a href="mailto:productsupport@horizonhobby.com">productsupport@horizonhobby.com</a> 877-504-0233	
	Sales	<a href="mailto:websales@horizonhobby.com">websales@horizonhobby.com</a> 800-338-4639	
EU	Horizon Technischer Service	<a href="mailto:service@horizonhobby.eu">service@horizonhobby.eu</a>	Hanskampring 9 D 22885 Barsbüttel, Germany
	Sales: Horizon Hobby GmbH	+49 (0) 4121 2655 100	

## Compliance Information for United States

### FCC Information—

**DXS Transmitter FCC ID: BRWKATY1T**

**AR410 Receiver FCC ID: BRWTASPMAR410**

**NOTICE:** Modifications to this product will void the user's authority to operate this equipment.

This product contains a radio transmitter with wireless technology which has been tested and found to be compliant with the applicable regulations governing a radio transmitter in the 2.400GHz to 2.4835GHz frequency range.

When operating your Spektrum receiver, please be sure to maintain a separation distance of at least 20 cm between your body (excluding fingers, hands, wrists, ankles and feet) and the antenna to meet RF exposure safety requirements as determined by FCC regulations.

### Supplier's Declaration of Conformity

Spektrum DXS Transmitter and AR410 4-CH Receiver: SPM1010

Spektrum DXS Transmitter only: SPMR1010

**FC** This device complies with part 15 of the FCC Rules. Operation is subject to the following two conditions: (1) This device may not cause harmful interference, and (2) this device must accept any interference received, including interference that may cause undesired operation.



**CAUTION:** Changes or modifications not expressly approved by the party responsible for compliance could void the user's authority to operate the equipment.

**NOTE:** This equipment has been tested and found to comply with the limits for a Class B digital device, pursuant to part 15 of the FCC Rules. These limits are designed to provide reasonable protection against harmful interference in a residential installation. This equipment generates, uses and can radiate radio frequency energy and, if not installed and used in accordance with the instructions, may cause harmful interference to radio communications. However, there is no guarantee that interference will not occur in a particular installation. If this equipment does cause harmful interference to radio or television reception, which can be determined by turning the equipment off and on, the user is encouraged to try to correct the interference by one or more of the following measures:

- Reorient or relocate the receiving antenna.
- Increase the separation between the equipment and receiver.
- Connect the equipment into an outlet on a circuit different from that to which the receiver is connected.
- Consult the dealer or an experienced radio/TV technician for help.

Horizon Hobby, LLC

2904 Research Rd.,

Champaign, IL 61822

Email: [compliance@horizonhobby.com](mailto:compliance@horizonhobby.com)

Web: [HorizonHobby.com](http://HorizonHobby.com)

## Compliance Information for Canada

---

### IC Information

**DXS Transmitter IC: 6157A-KATY1T**

**AR410 Receiver IC: 6157A-TASPMAR410**

**CAN ICES-3 (B)/NMB-3(B)**

This device complies with ISED Canada license-exempt RSS standard(s). Operation is subject to the following two conditions: (1) this device may not cause interference, and (2) this device must accept any interference, including interference that may cause undesired operation of the device.

## Compliance Information for the European Union

---



Horizon Hobby, LLC hereby declares that this product is in compliance with the essential requirements and other relevant provisions of the RED Directive. A copy of the EU Declaration of Conformity is available online at:

<http://www.horizonhobby.com/content/support-render-compliance>.

Frequency Band: 2402 - 2478 MHz

Max EIRP: 20dBm

### Instructions for Disposal of WEEE by Users in the European Union



This product must not be disposed of with other waste. Instead, it is the user's responsibility to dispose of their waste equipment by handing it over to a designated collection point for the recycling of waste electrical and electronic equipment. The separate collection and recycling of your waste equipment at the time of disposal will help to conserve natural resources and ensure that it is recycled in a manner that protects human health and the environment. For more information about where you can drop off your waste equipment for recycling, please contact your local city office, your household waste disposal service or where you purchased the product.



**E328**



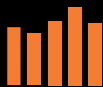

**SPEKTRUM®**

© 2020 Horizon Hobby, LLC.

DSM, DSM2, DSMX, Spektrum Airware, SRXL2, SmartSafe, Hangar 9 and the Horizon Hobby logo are trademarks or registered trademarks of Horizon Hobby, LLC.

The Spektrum trademark is used with permission of Bachmann Industries, Inc.

JR is a registered trademark of JR Americas. All other trademarks, service marks and logos are property of their respective owners.

US 7,391,320. US 9,056,667. US 9,753,457. US 9,930,567. US 10,078,329. US 10,419,970.

59922.3

Created 06/20

SPM1010, SPMR1010