

HEXBUG®

VEX®  
ROBOTICS

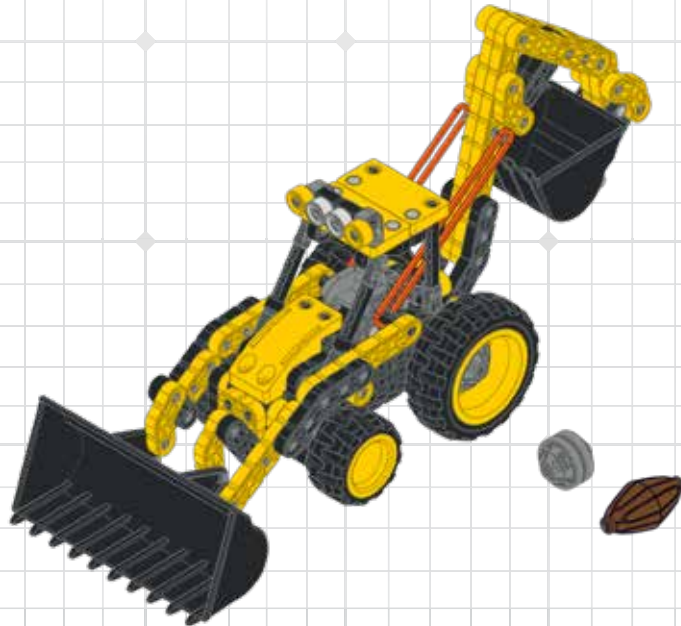

BACKHOE™

# PARENT/GUARDIAN • PARENT/TUTEUR • PADRE/GUARDIÁN • RODZIC/OPIEKUN • VANHEMPI /HUOLTAJA • FÖRÄLDER / MÅLSMAN

Part Size • Taille de la pièce • Tamaño de la pieza •  
Teilegröße • Dimensione parte • Wielkośc części • Osan  
koko • Delstorlek • Delstørrelse • Del Størrelse • 零件尺寸

Quantity • Quantité •  
Cantidad • Menge •  
Quantità • Ilość •  
Määrä • Mängd •  
Antall • Antal •  
數量

1x

228-4133-004

1x5

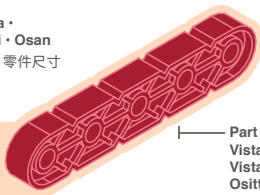

Part View • Vue de la pièce •  
Vista de la pieza • Teilansicht •  
Vista parte • Widok części •  
Osittainen näkymä • Del bild •  
Delvisning • Delvisning •  
零件圖示

Part Number • Numéro de pièce • Número de  
la pieza • Teilenummer • Numero di parte •  
Numer części • Osannumero • Artikelnummer  
• Delnummer • Del Nummer • 零件編號

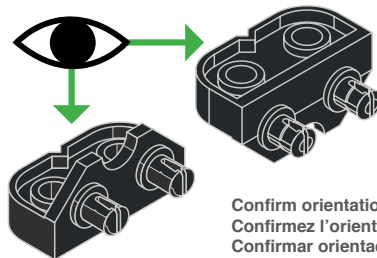

Confirm orientation  
Confirmez l'orientation  
Confirmar orientación  
Ausrichtung prüfen  
Confirmare l'orientamento  
Potwierdź orientację  
Vahvista suunta  
Bekräfta riktning  
Bekreft retning  
Sørg for, at de vender rigtigt  
確定零件安裝方向

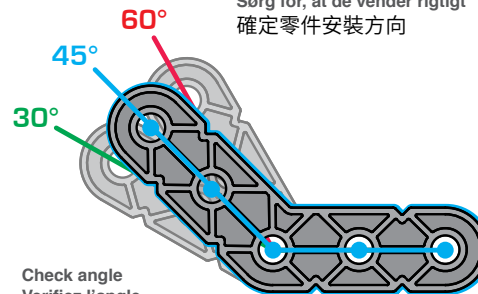

Check angle  
Verifiez l'angle  
Verificación de ángulo  
Winkel prüfen  
Controllare l'angolazione  
Sprawdź kąt  
Tarkista kulma  
Kontrollera vinkel  
Sjekk vinkel  
Tjek vinklen  
檢查零件角度

Alert Alerte Alerta Warnung Attenzione Ostrzeżenie Varoitus Varning Varsle Alarm 警告	Correct Correcte Correcto Richtig Corretto Prawidłowo Varoitus Rätt Riktig Korrekt 正確	Incorrect Incorrecte Incorrecto Falsch Non corretto Nieprawidłowo Väärä Fel Feil Forkert 錯誤	Flip Retourner Voltear Umdrehen Capovolgere Przerzuc Käännä Vänd Vend Flip 翻轉	Rotate Liquider Faire tourner Girar Drehen Ruotare Obróć Pyöritä Rotera Roter Drej 旋轉	Wind up Liquider Dar cuerda Aufziehen Arrotola Nawin Kierrä Drag upp Trek opp Træk op 捲起	Notice Avis Aviso Hinweis Fare attenzione Zwróć uwagę Huomaa OBS Merknad Bemærk 注意

Sticker Autocollant Calcomania Aufkleber Etichetta Naklejka Tarra Klistermärke Klistrermerke Klistermærke 貼紙	Zoom view Zoom Vista con zoom Zoom-Ansicht Vista con zoom Powiększenie Suurennettu näkymä Zoom vy Zoom-visning Zoom visning 放大查看	Alternate view Autre vue Vista alternativa Zoom-Ansicht Vista alternativa Widok alternatywny Vaihtoehtoinen näkymä Alternativ vy Alternativ visning Alternativ vinkel 多視角查看	Connectors Connecteurs Conectores Anschlüsse Connettori Złącza Liittimet Anslutningar Kontaktpunkter Stik 連接頭	Electrical Électrique Eléctrico Elektrik Elettrico Elektryczne Sähköinen Elektrisk Elektrisk Elektrisk 電子件	Motion Déplacement Movimiento Bewegung Movimento Ruch Liike Rørelse Bevegelse Bevægelse 運動件	Structure Structure Estructura Struktur Struttura Konstrukcja Rakenne Struktur Struktur Bygning 結構件

• ELTERN/ ERZIEHUNGSBERECHTIGTE • GENITORE/TUTORE  
 • VOKSEN/ VERGE • FORÆLDER/VÆRGE • 家長

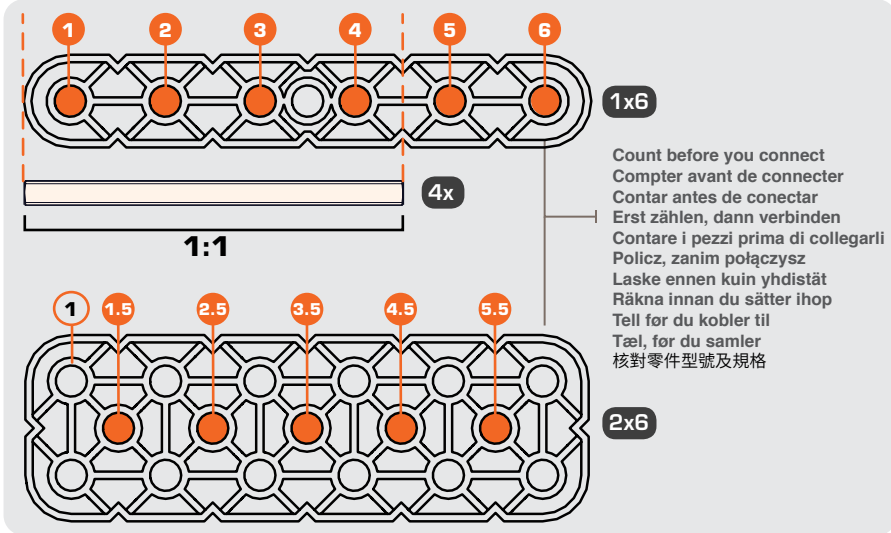

1x6

Count before you connect  
 Compter avant de connecter  
 Contar antes de conectar  
 Erst zählen, dann verbinden  
 Contare i pezzi prima di collegarli  
 Policz, zanim połączysz  
 Laske ennen kuin yhdistät  
 Räkna innan du sätter ihop  
 Tell før du kobler til  
 Tæl, før du samler  
 核對零件型號及規格

2x6

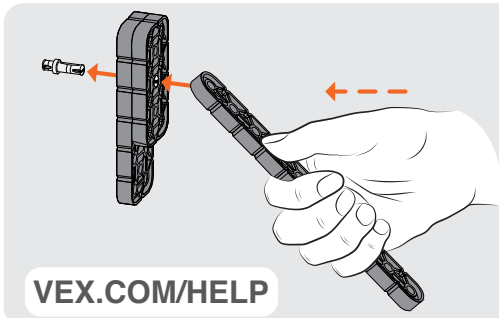

Remove connectors  
 Retirez connecteurs  
 Retirar conectores  
 Verbindungsstücke entfernen  
 Rimuovere i connettori  
 Wyjmij łączniki  
 Poista liittimet  
 Ta bort kopplingar  
 Fjern kontaktpunkter  
 Fjern koblingsdelene  
 移除連接頭

VEX.COM/HELP

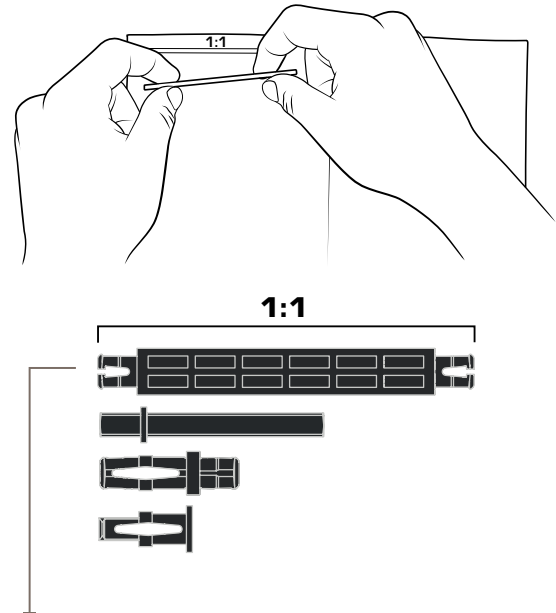

Check pieces against actual size in manual  
 Vérifiez les pièces contre leurs tailles réelles dans le manuel  
 Verificar partes contra tamaño real en el manual  
 Bauteile mit der originalgröße in der Anleitung vergleichen  
 Controllare le dimensioni dei pezzi nel manuale rispetto alla grandezza naturale  
 Sprawdź elementy względem rzeczywistego rozmiaru w instrukcji  
 Tarkista kappaleiden todellinen koko vertaamalla ohjekirjaan  
 Kontrollera bitarnas storlek mot storleken i handboken  
 Sjekk delene mot faktisk størrelse i manualen  
 Tjek, om brikkerne passer med den rigtige størrelse i manualen  
 檢查零件的實際尺寸並與說明書上的尺寸比對

# PARTS/ LES PIÉCES/ PARTES/ BAUTEILE/ PARTI/ CZESCI/ OSAT/ DELAR / DELER/ BYGGEDELE/ 零件清單

**3x** **1x2**  
228-3449-001



**6x** **1x3**  
228-3201-002



**4x** **1x4**  
228-3201-003

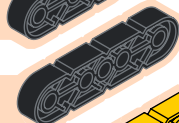

**2x** **1x5**  
228-3449-004

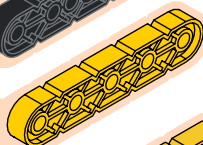

**4x** **1x6**  
228-3449-005

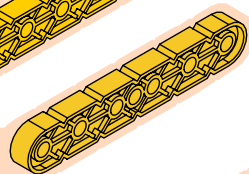

**1x** **2x2**  
228-3449-017

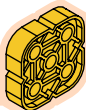

**2x** **2x10**  
228-3201-025

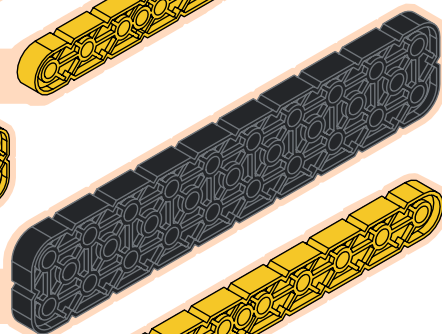

**2x** **1x10**  
228-3449-009

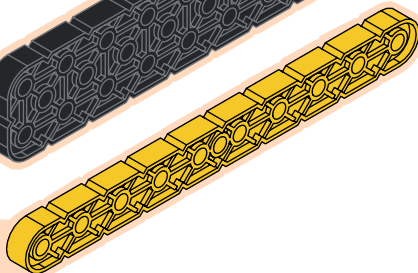

**6x** **1x1**  
228-3449-154



**2x** **1x1**  
228-3943-154



**6x** **2x2 45**  
228-3449-1486

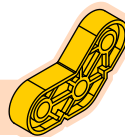

**2x** **3x3 45**  
228-3449-148

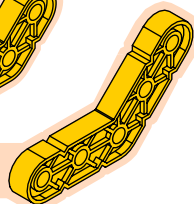

**2x**  
228-7258-1911



**4x** **3x3 30**  
228-3201-147

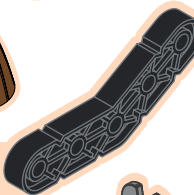

**4x** **2x2**  
228-3944-1925



**1x**  
228-3944-1858

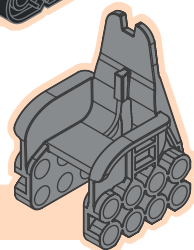

2x

2x4

228-3449-520

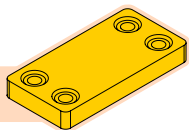

1x

2x1

228-3201-400

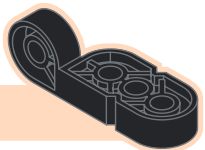

1x

2x1

228-3201-401

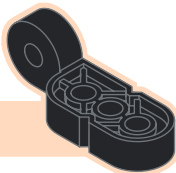

1x

228-3449-2109

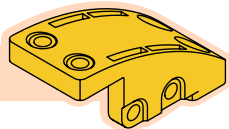

2x

3x4

228-3201-032

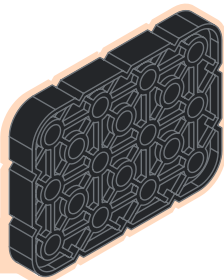

1x

228-3201-2028

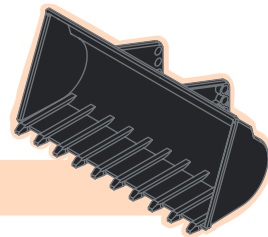

1x

228-3201-2029

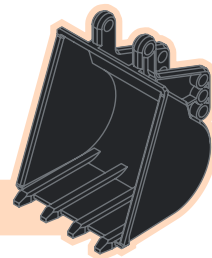

# PARTS/ LES PIÈCES/ PARTES/ BAUTEILE/ PARTI/ CZESCI/ OSAT/ DELAR / DELER/ BYGGEDELE/ 零件清單

14x **0x2**  
228-5573-086

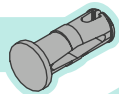

1x **0.5x**  
228-3944-064

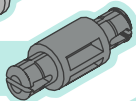

8x **1x2**  
228-5573-061

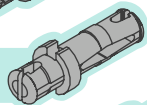

14x **2x2**  
228-3616-062

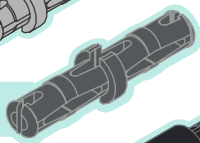

2x **1x**  
228-3201-065

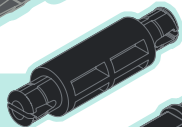

2x **2x**  
228-3201-078

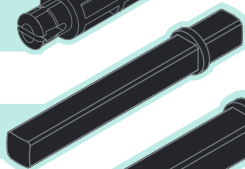

2x **2x**  
228-3201-080

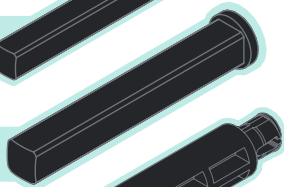

2x **2x**  
228-3201-067

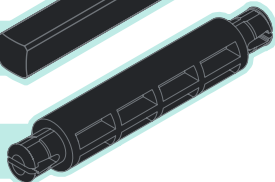

2x **0.25x**  
228-3201-063

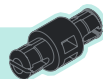

49x **1x1**  
228-3616-060

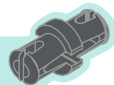

1x  
228-3616-170



2x **0.5x**  
228-3201-109



2x  
228-3944-127

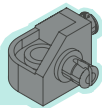

6x  
228-3616-172



1x  
228-3616-171

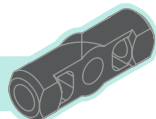

**6x**

228-3201-128

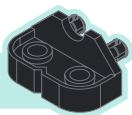

**2x**

228-3201-277

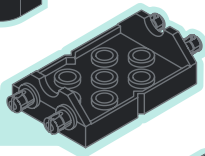

**1x**

228-3201-272

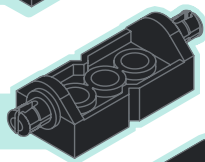

**3x**

228-3201-069

**3x**

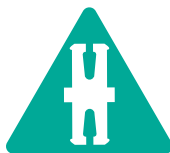
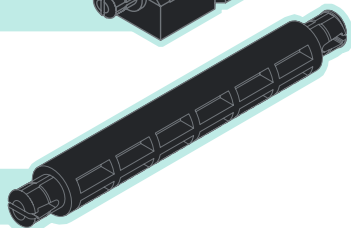

**6x**

228-3944-112



**4x**

228-2500-143



**2x**

228-3449-1950

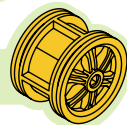

**2x**

228-3449-1953



**2x**

228-3201-1957



**2x**

228-3201-1956



**2x**

228-3446-1225

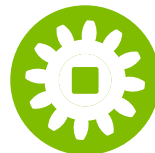
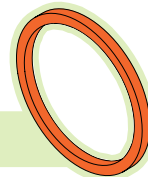

3x4

x1

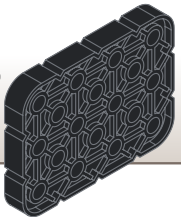

1x1

x5

1:1

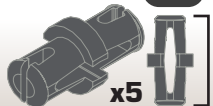

1x3

x1



1

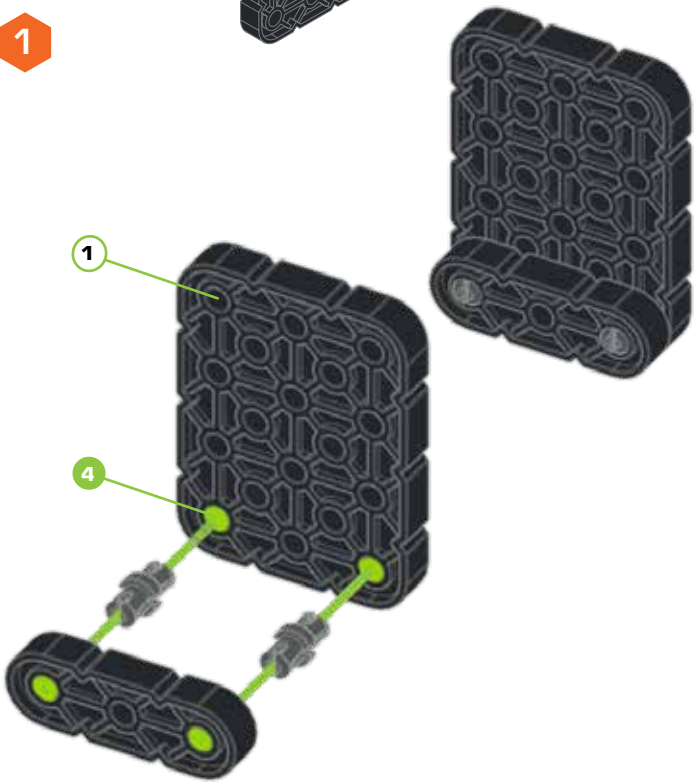

2

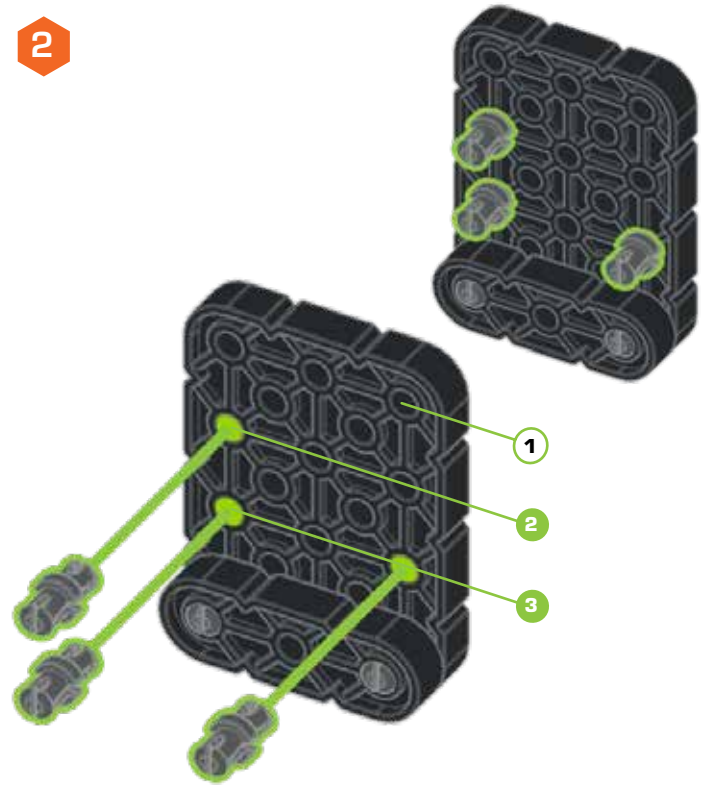



2x10



x1

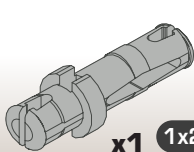

x1



1x2

1:1



x1

3

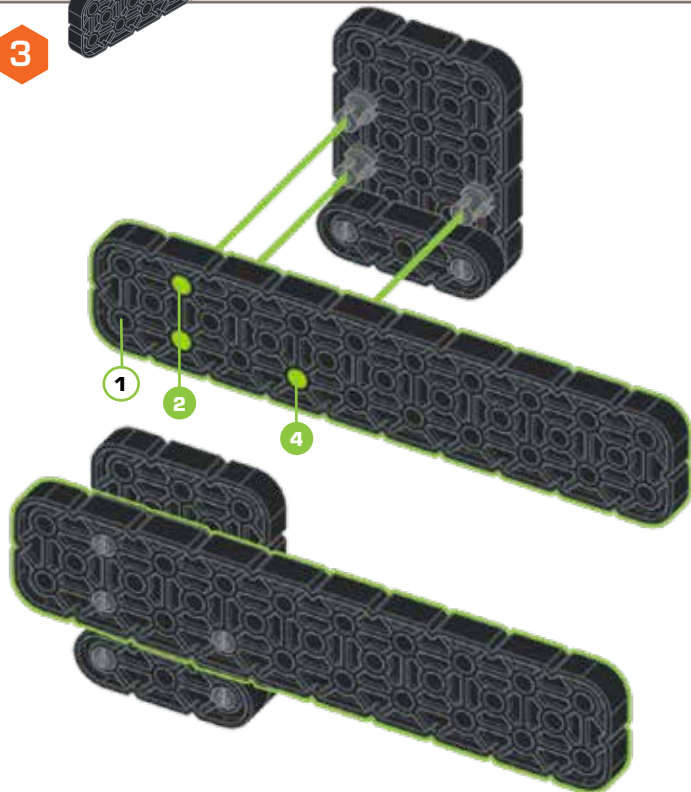

4

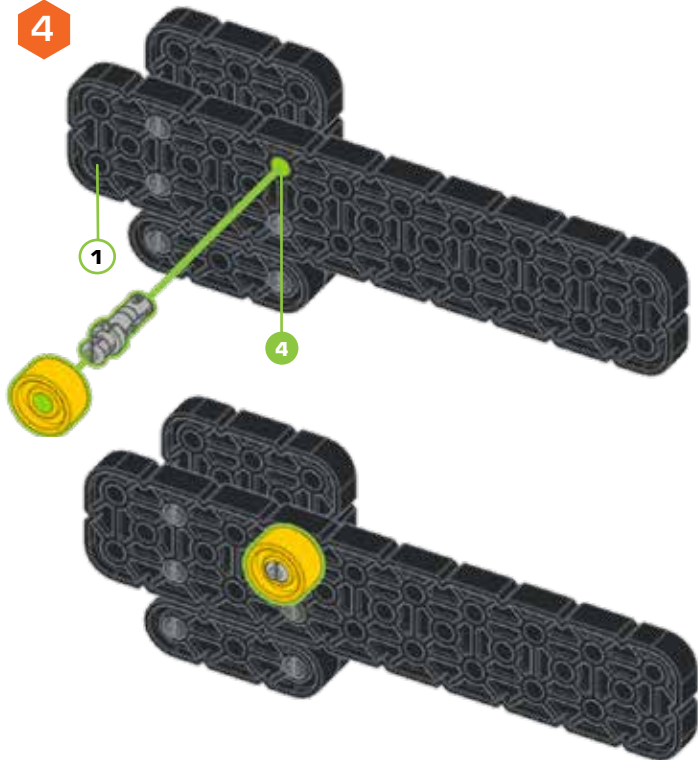



x2

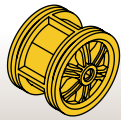

x2

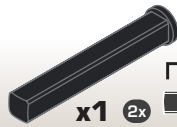

x1



1:1

x2



x1



x1

5

2X

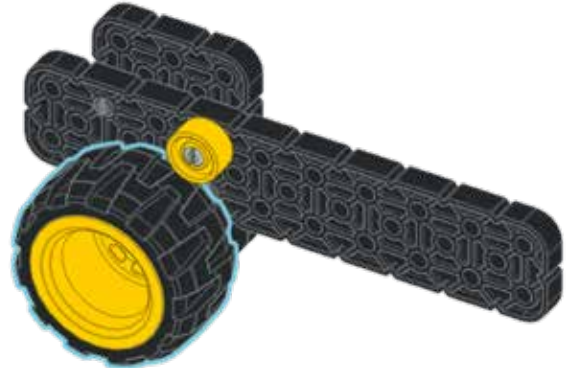
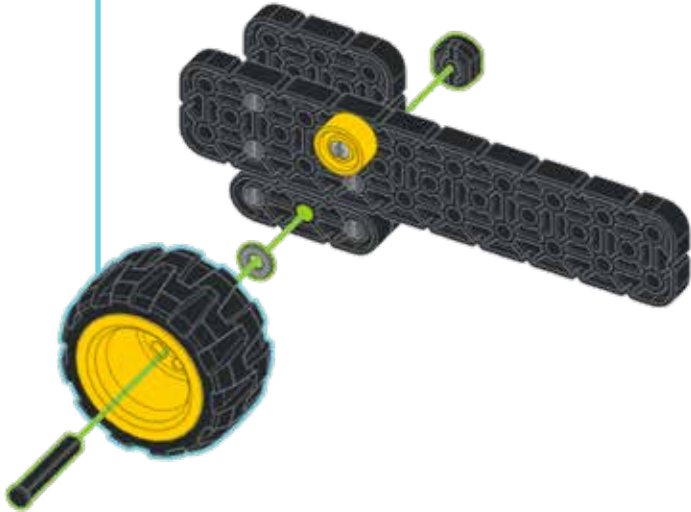
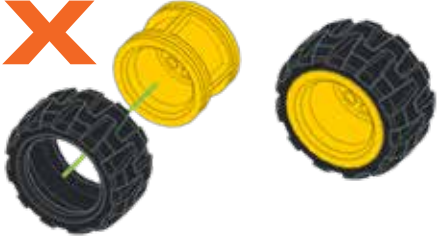

1x2

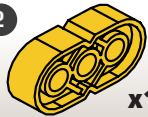

x1

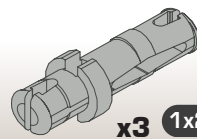

x3

1x2

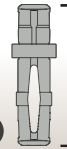

1:1

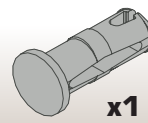

x1

0x2



1:1

2x2

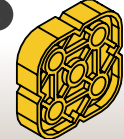

x1

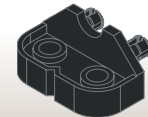

x2

6

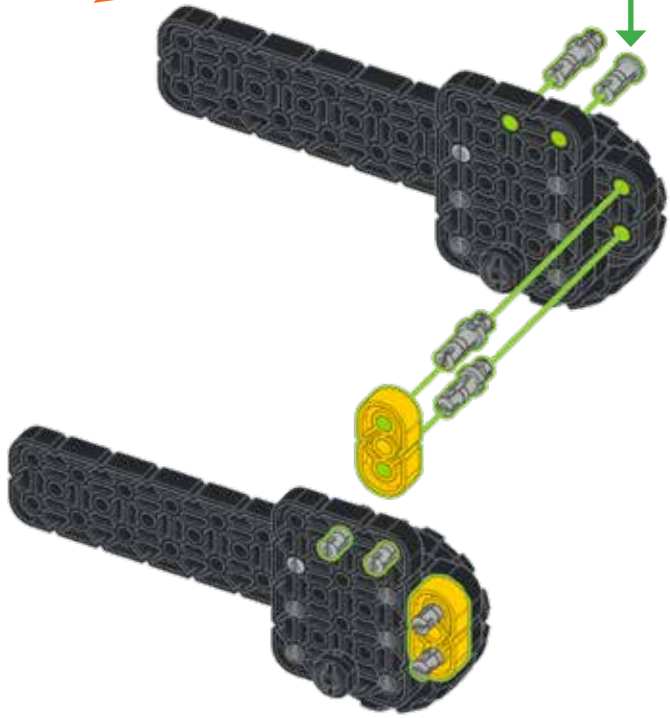

7

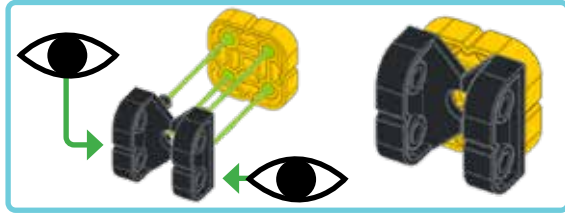

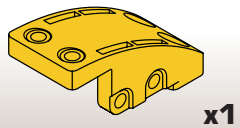
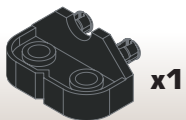

8

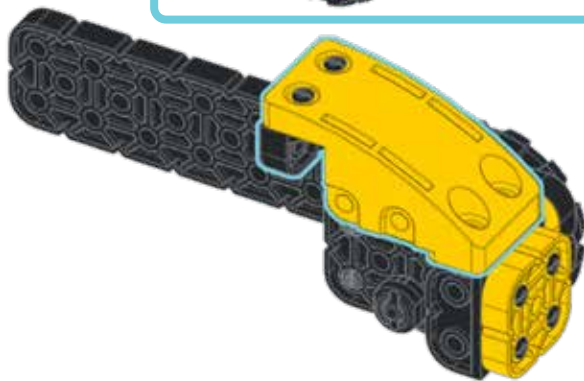
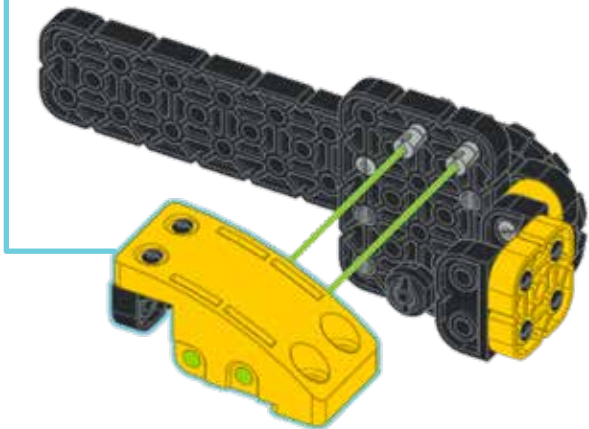
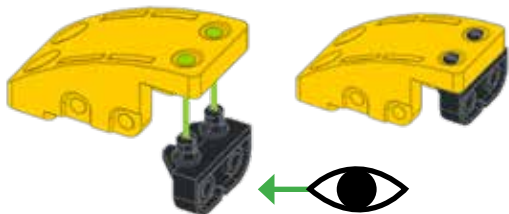

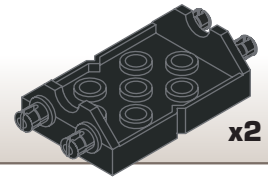
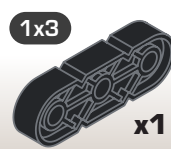
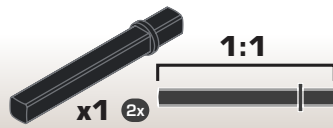
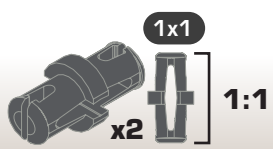

9



10

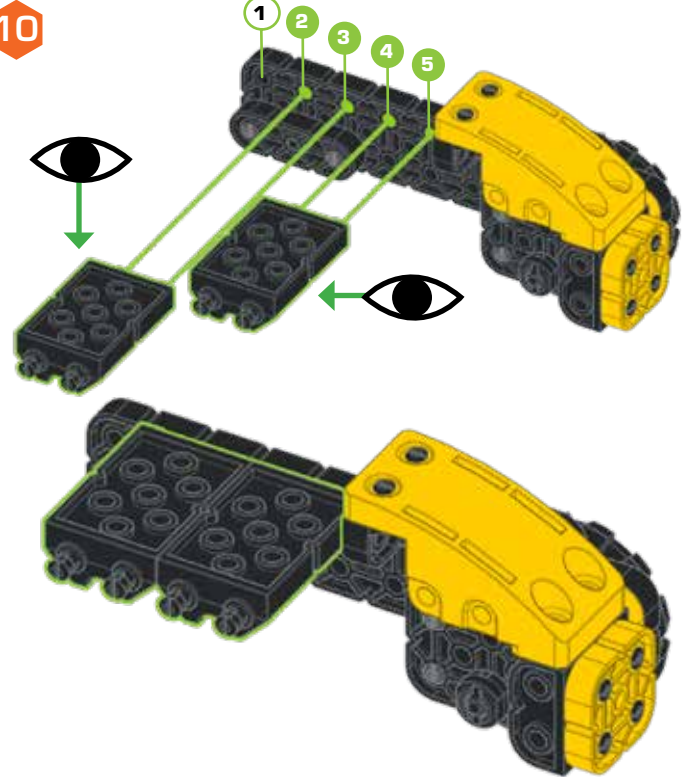

1x10

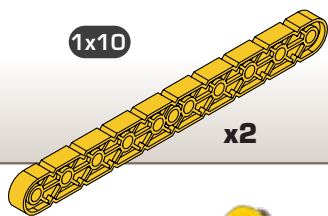

x2

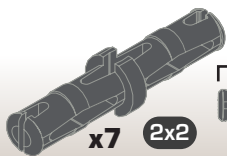

x7

2x2

1:1



x1

3x3 30°



x1

11

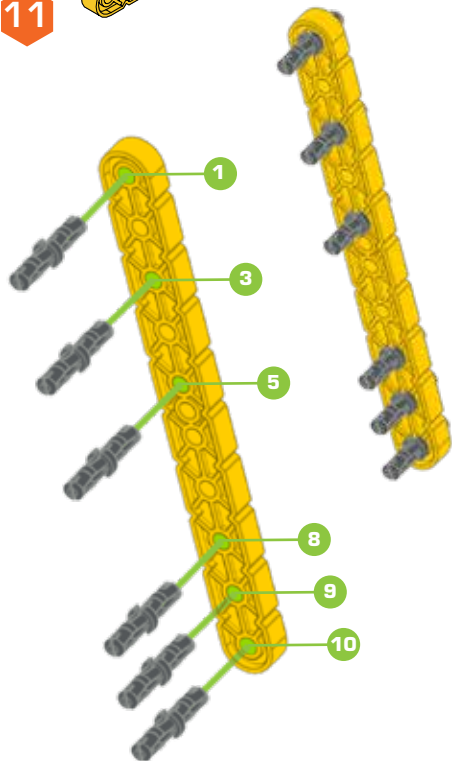

12

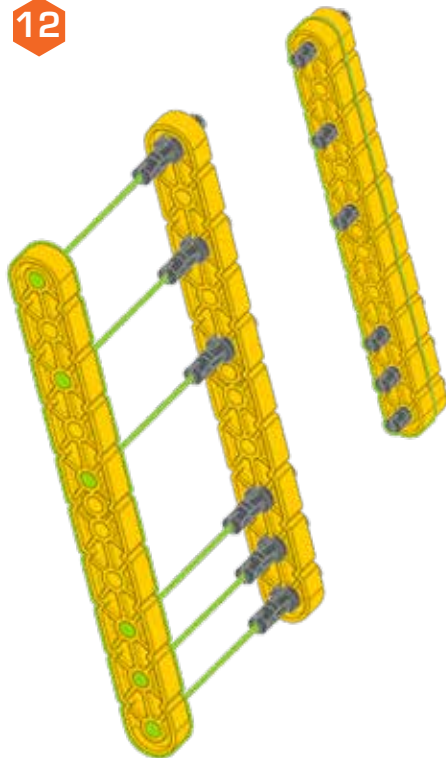

13



3x3 30°

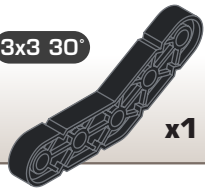

x1

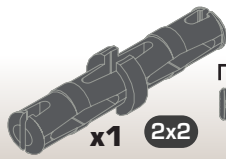

x1

2x2

1:1



x2

14



15

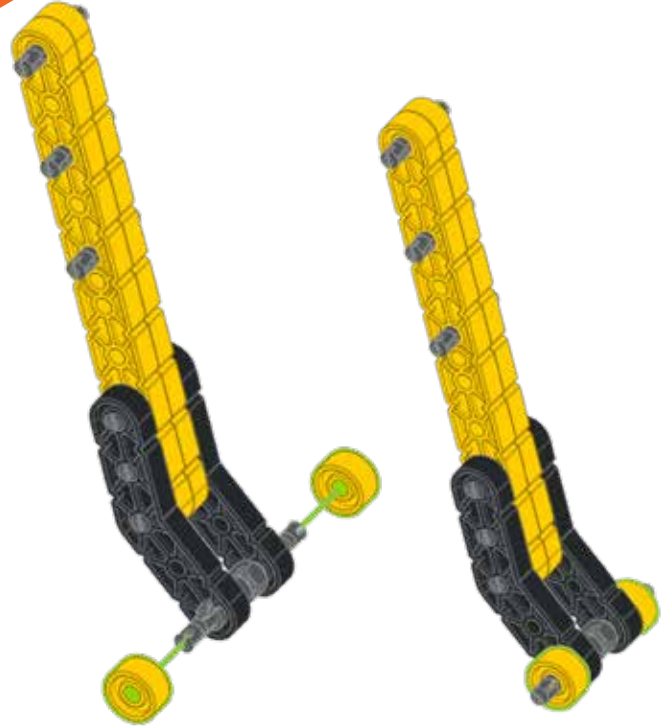

3x4  
x1

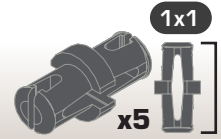
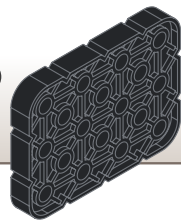

x5

1:1

1x3



x1

16



17

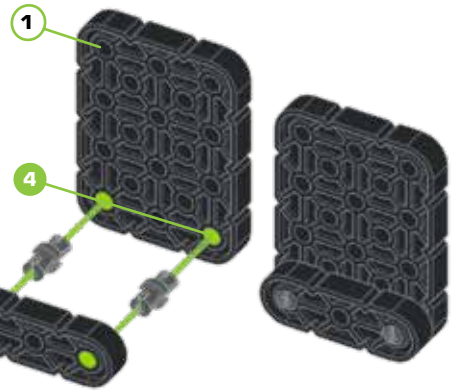

18

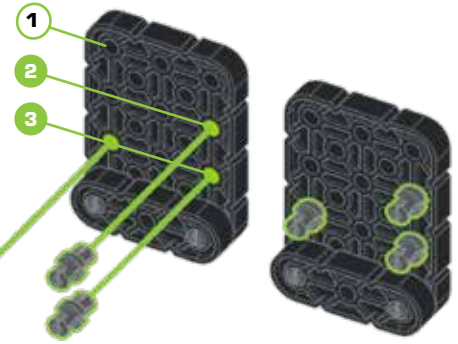



2x10



x1

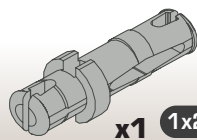

x1

1x2

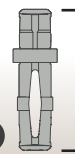

1:1



x1

19

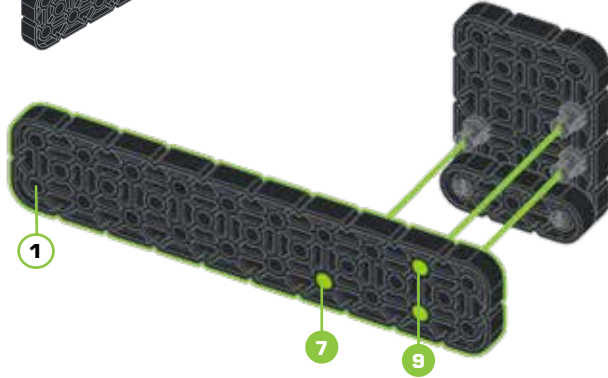

1

7

9

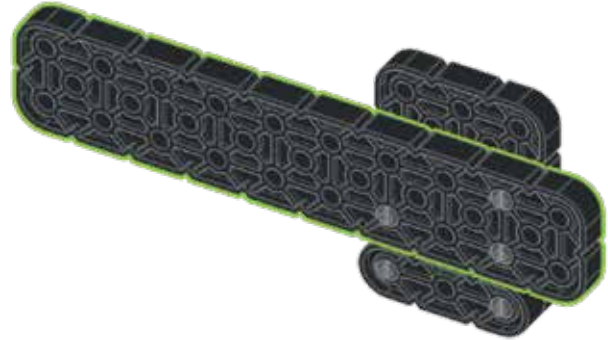

20

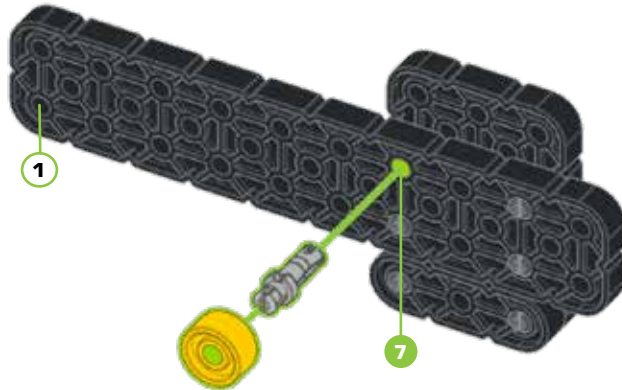

1

7

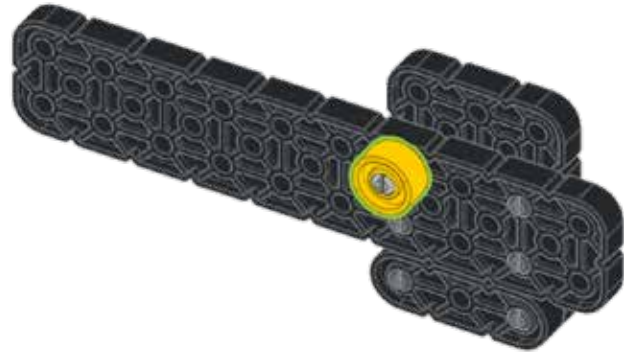

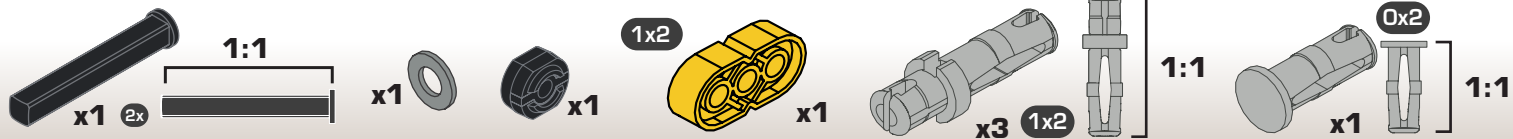

21



22

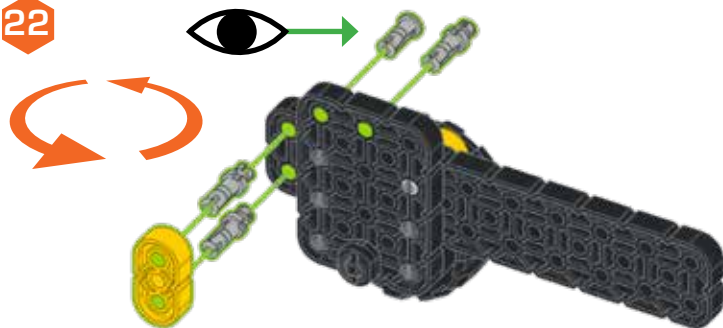

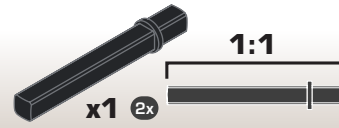
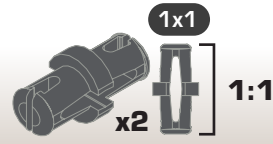
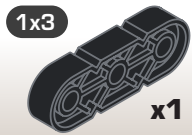

23

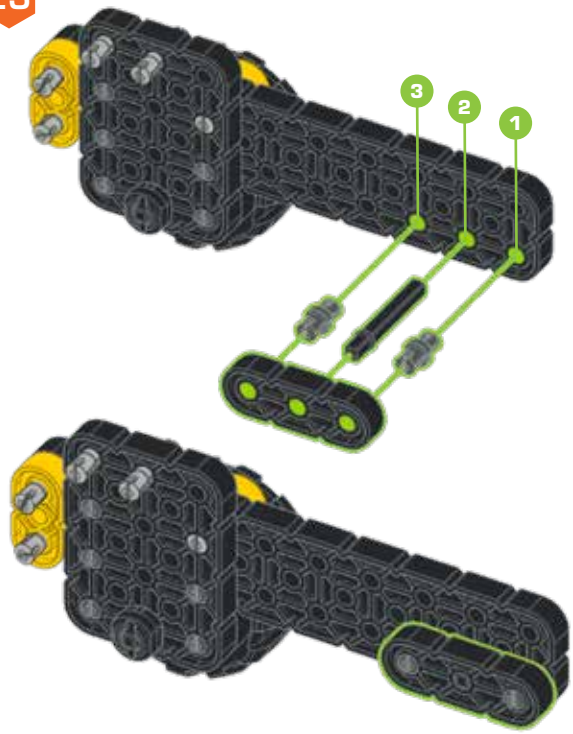

24

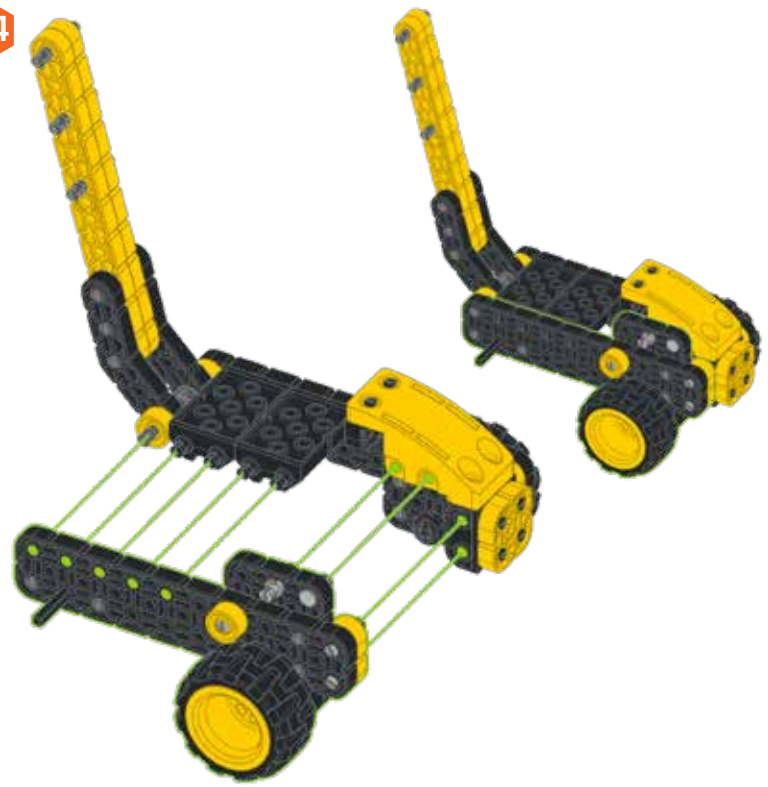



x2



x2

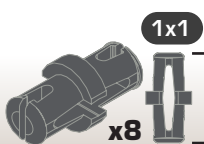

x8

1x1



1:1

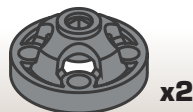

x2



x2



x2

25

2X



2X



2X



x2 



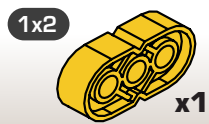
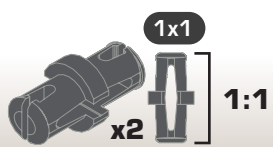
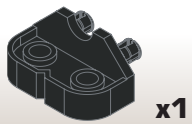

27

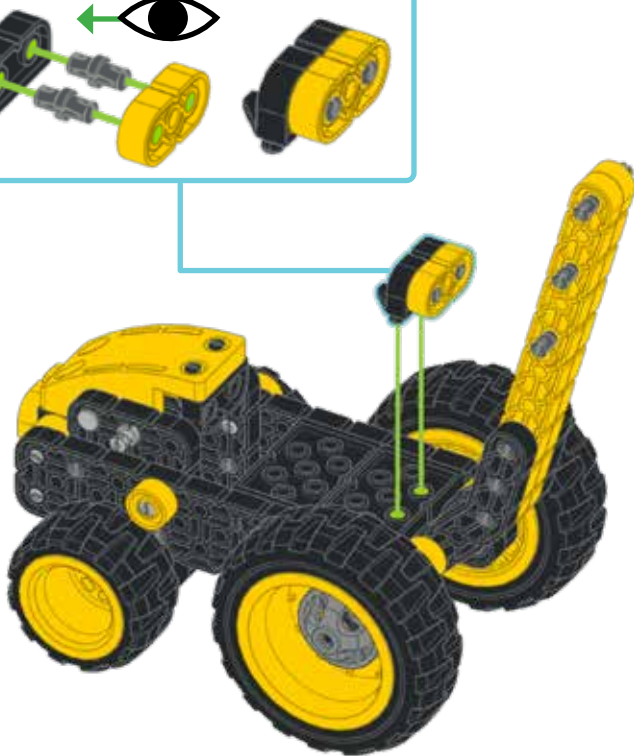
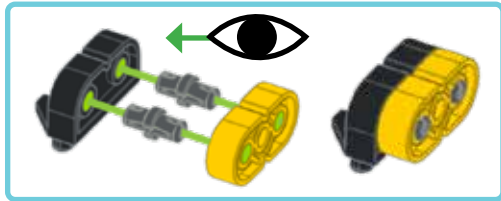



x1



x2

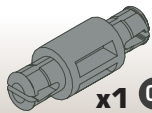

x1

0.5x



1:1



x2

0.25x



1:1

28

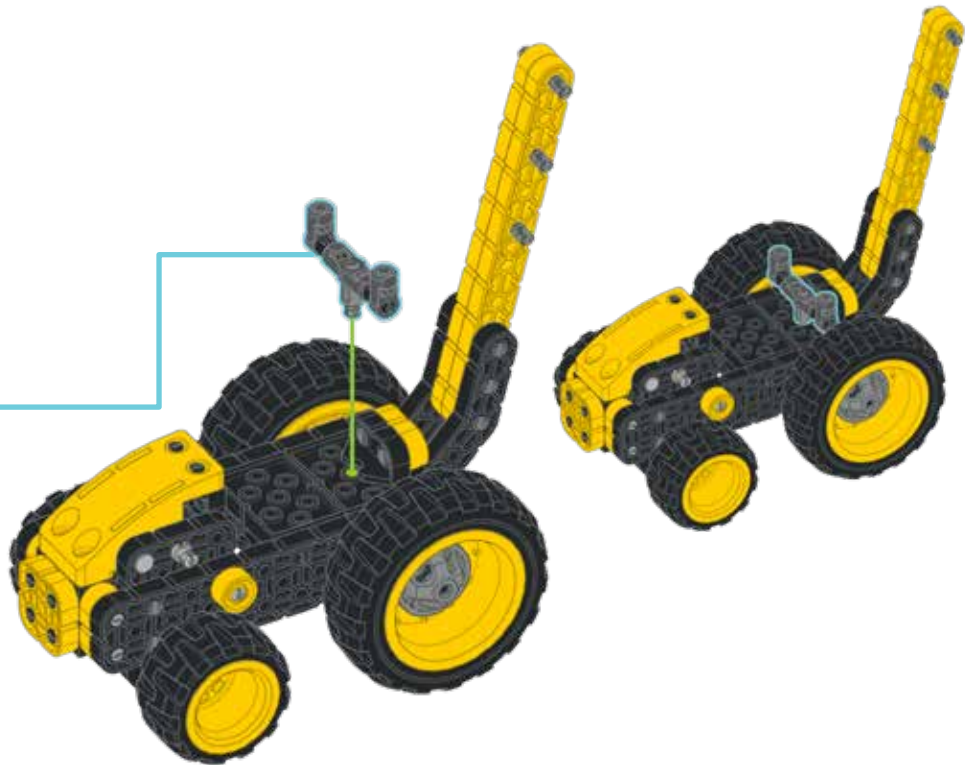
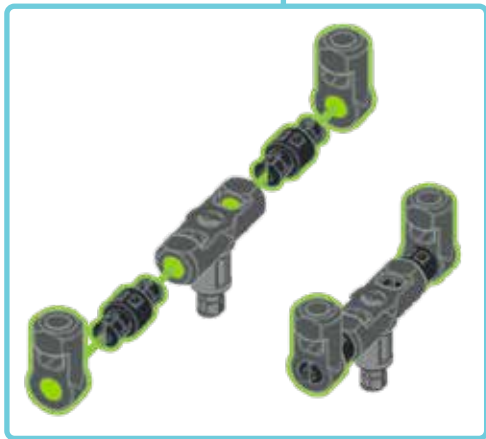
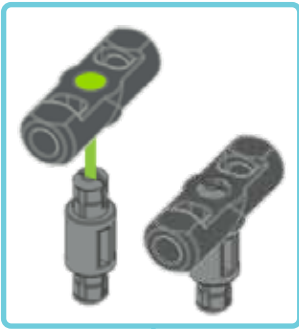

x1

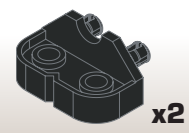
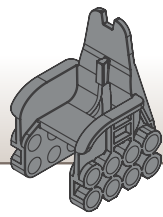

x2

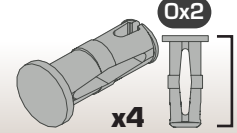

x4

0x2

1:1

29

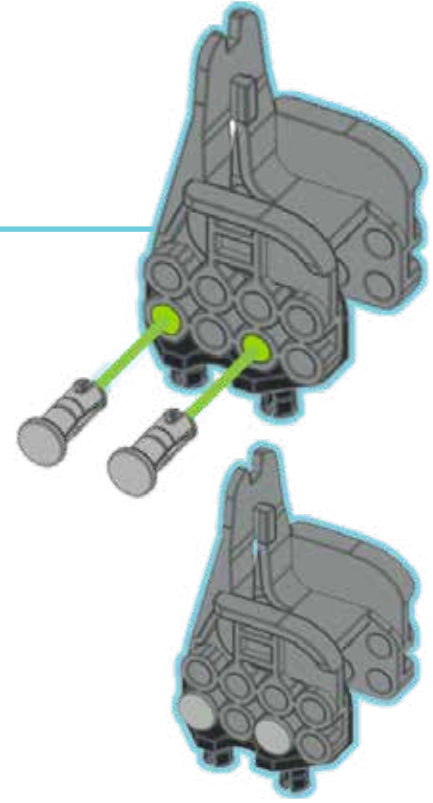
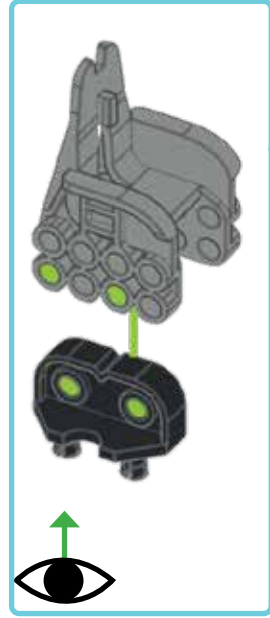

30

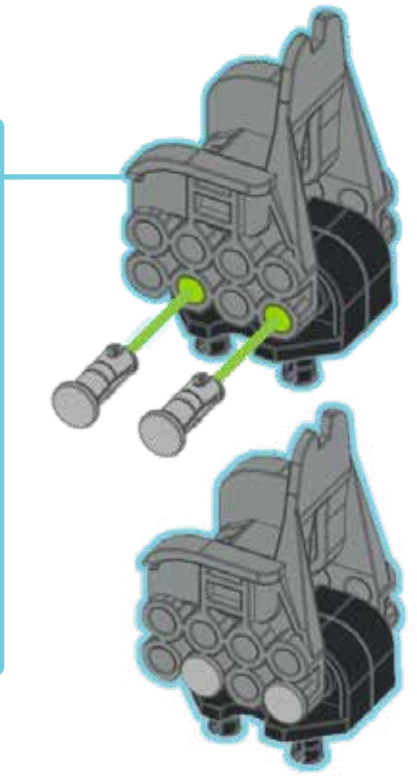



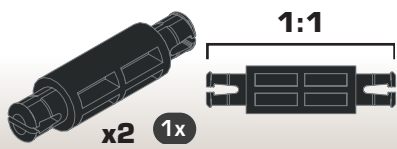

31

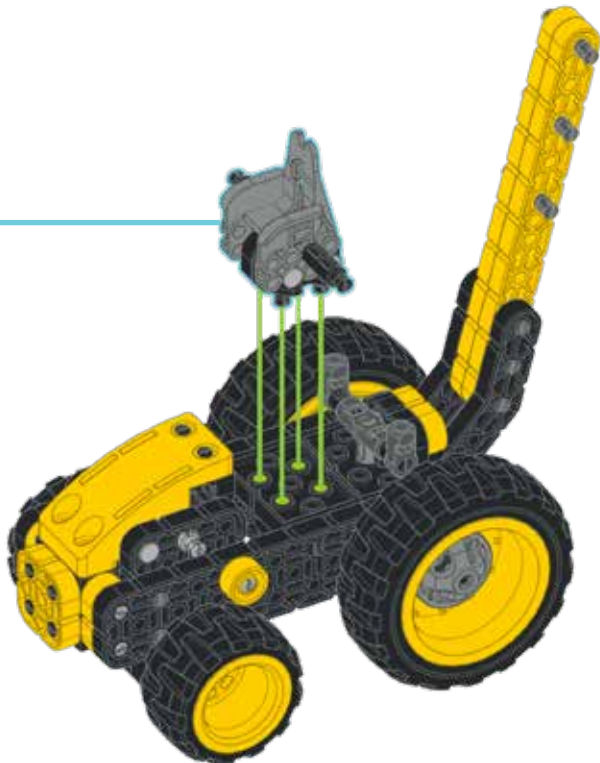
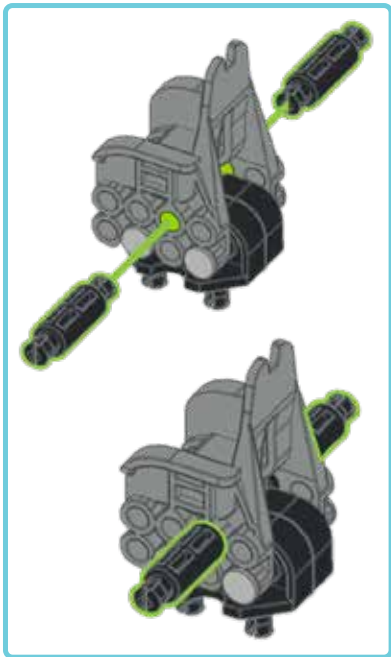

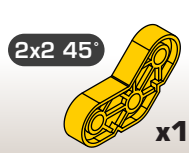
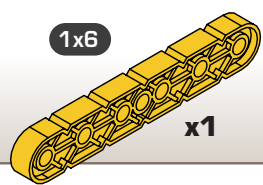

32



33

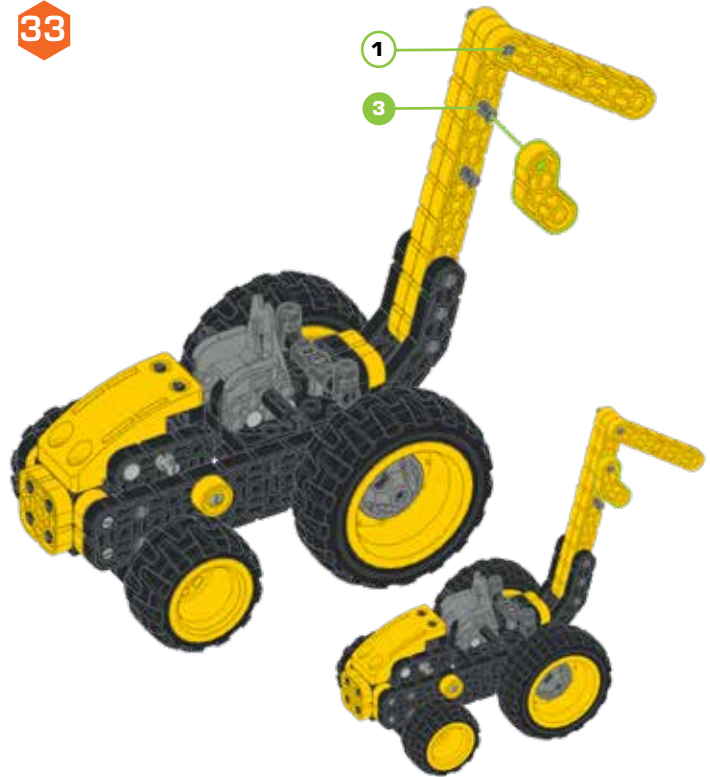

1x4

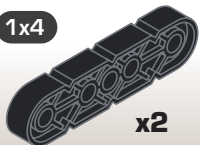

x2



x2

2x2

1:1



34



2x2 45°

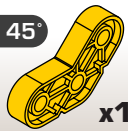

x1

35



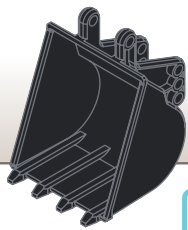

x1

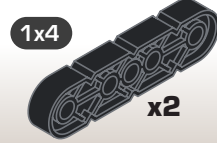

1x4

x2

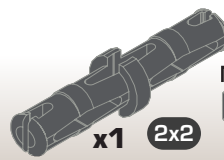

x1

2x2



1:1

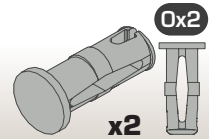

0x2

x2

1:1

36

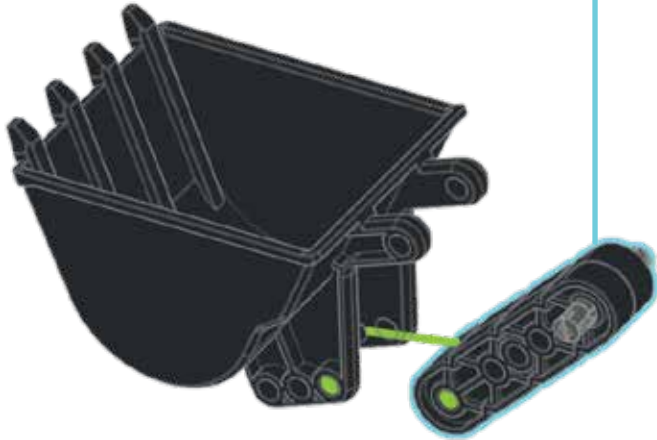
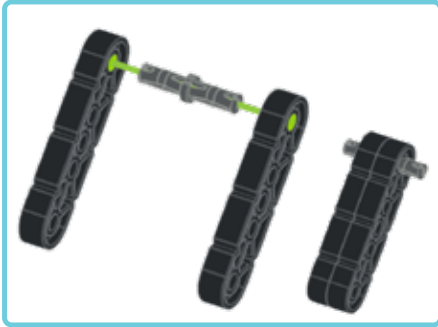

37



3x3 45°

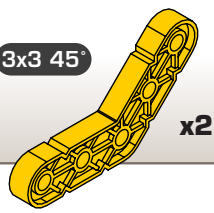

x2

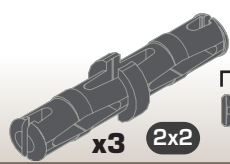

x3

2x2



1:1

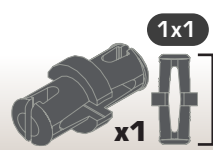

x1

1x1



1:1

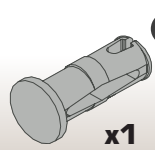

x1

0x2



1:1

38

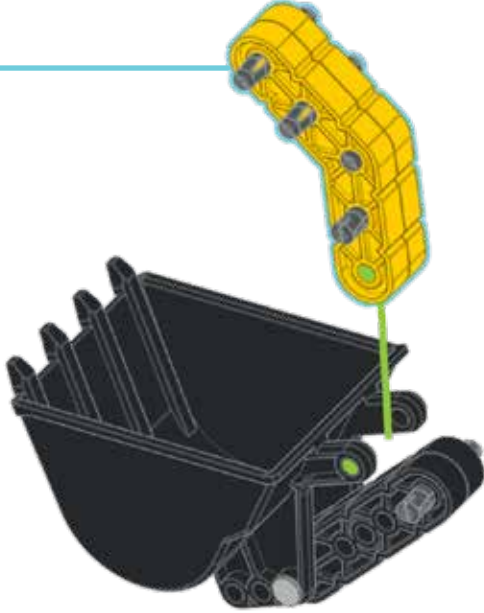
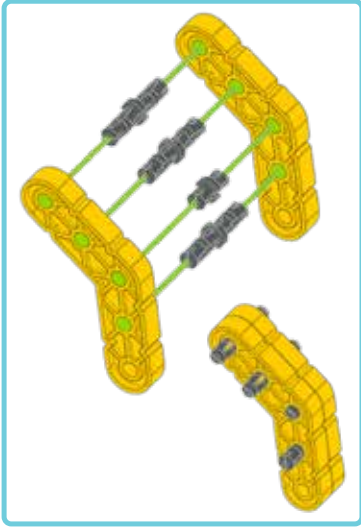

39

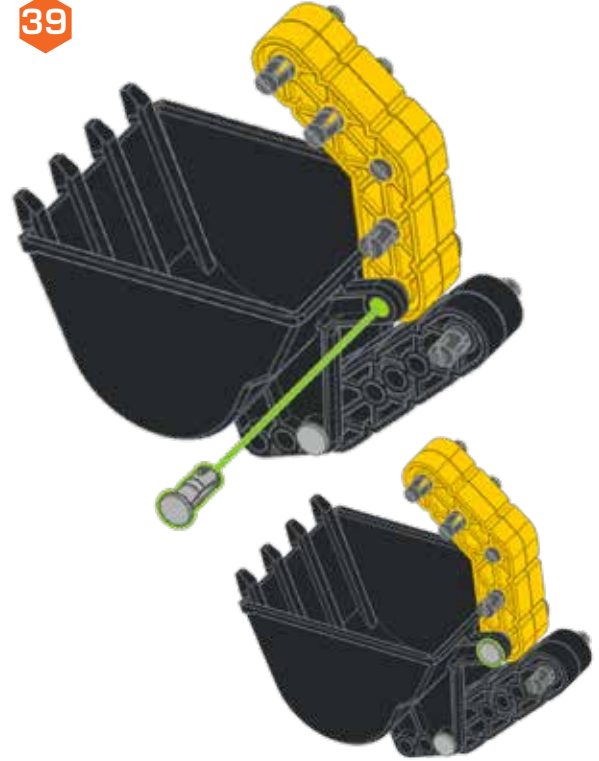

2x2 45°

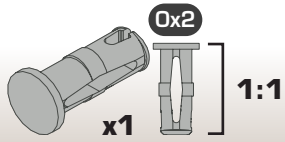
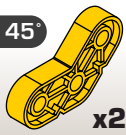

40

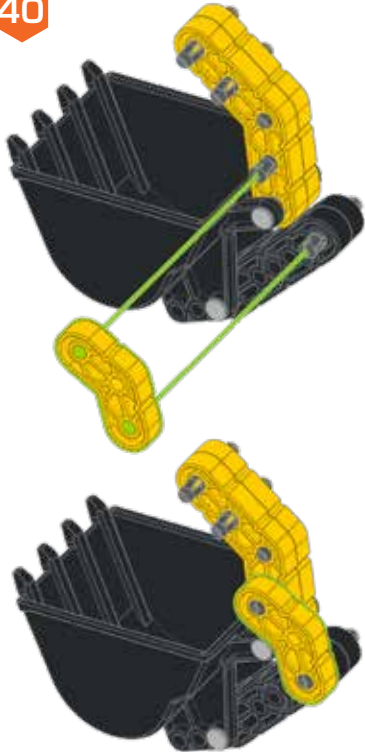

41

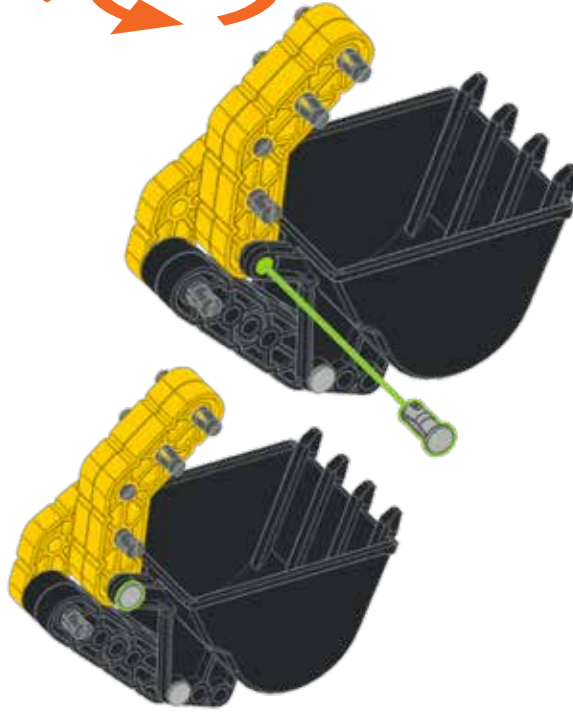

42

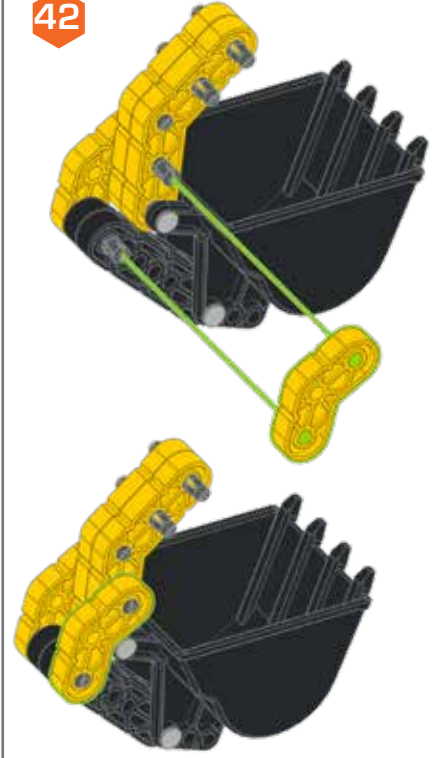

43

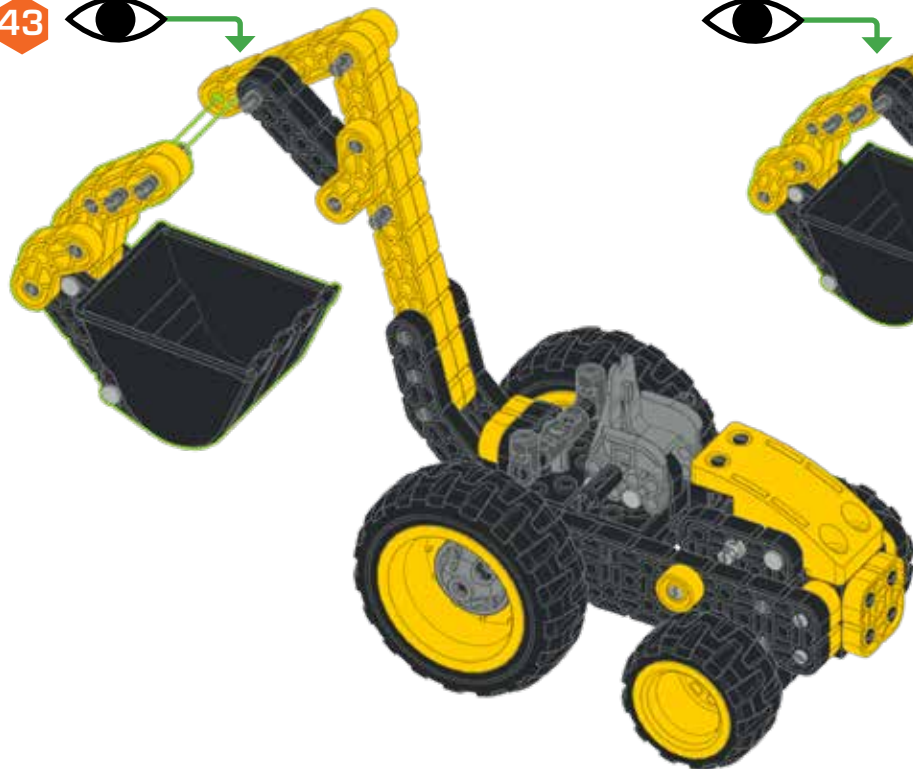



1x6

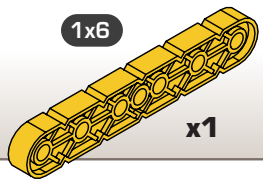

x1

44



x1



45



x1



46



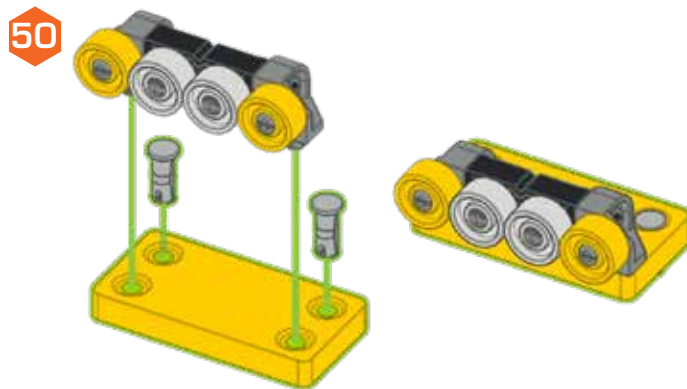
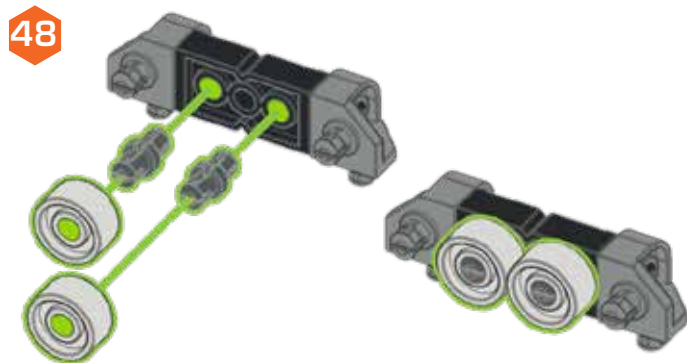
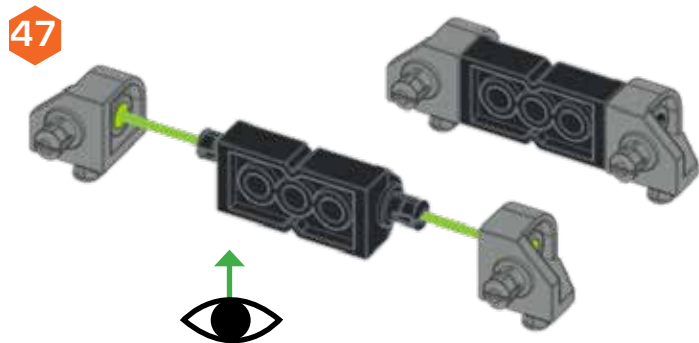
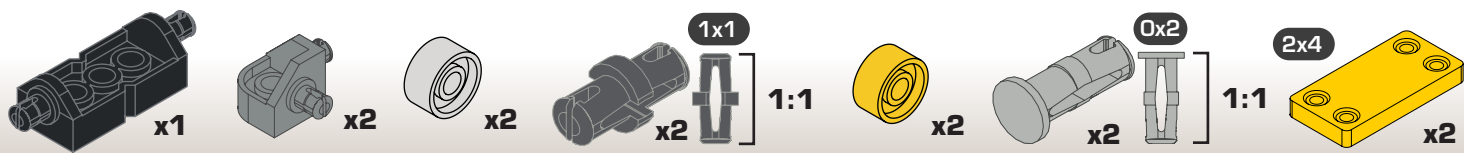

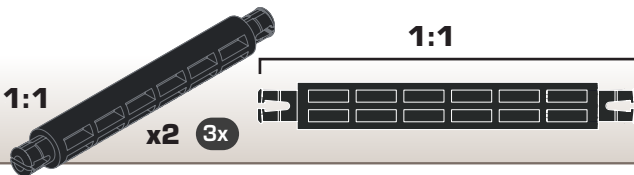
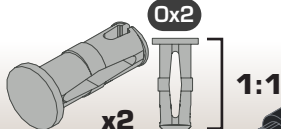
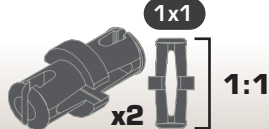
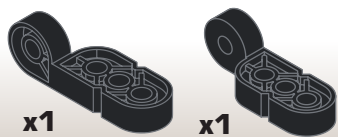

51

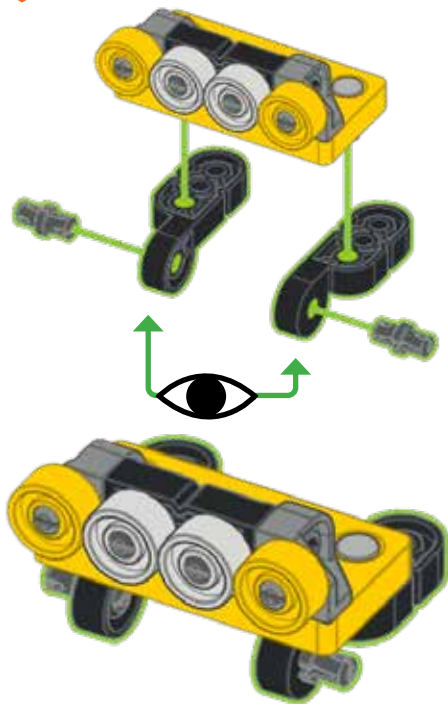

52

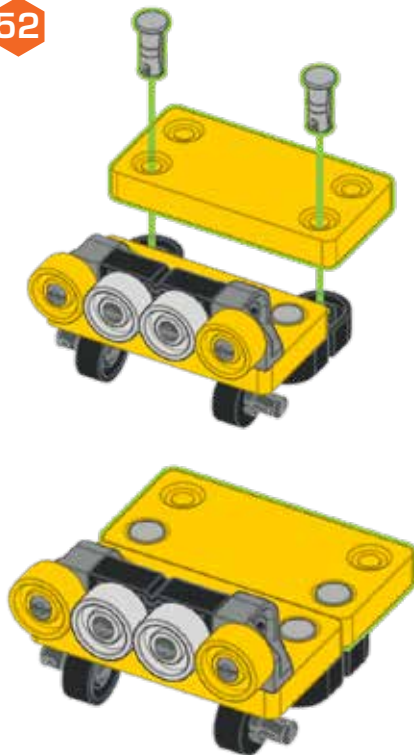

53







x4

0.5x



x2

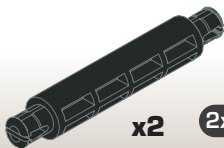

x2

2x

1:1



55



2X



56





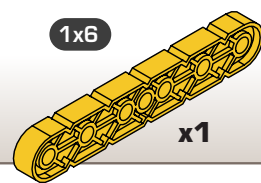
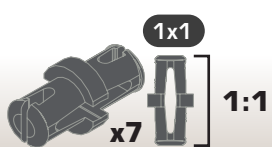
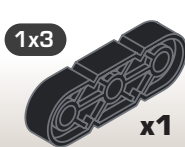
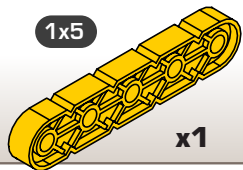

57

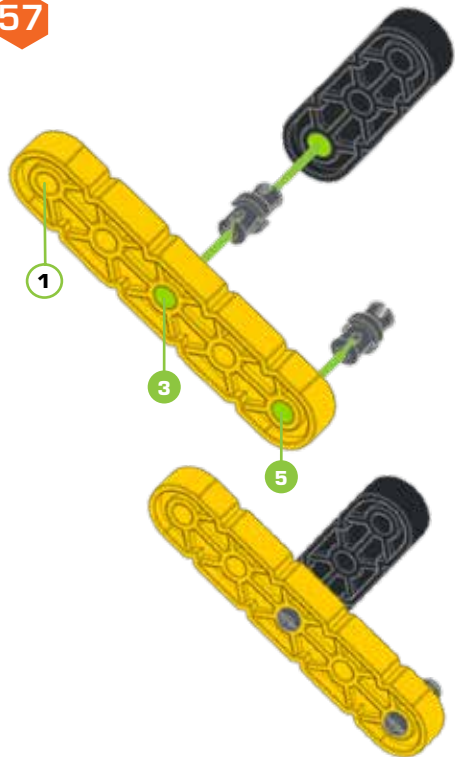

58

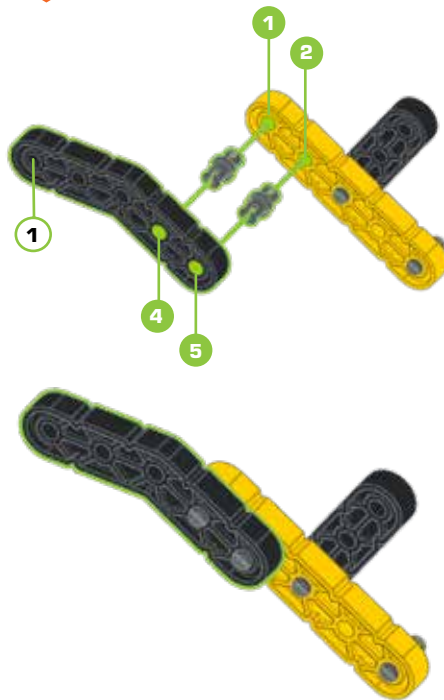

59

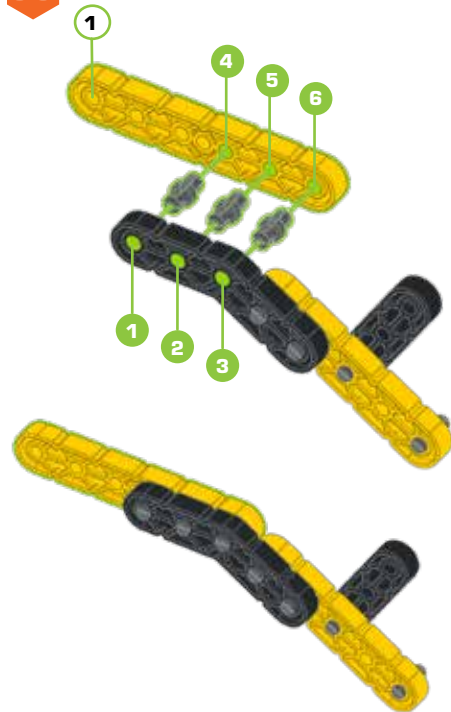

60



x1

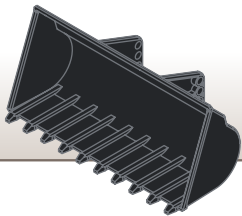

x4

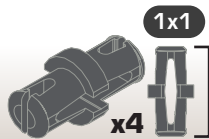

1x1

1:1

2x2 45°



x2

61

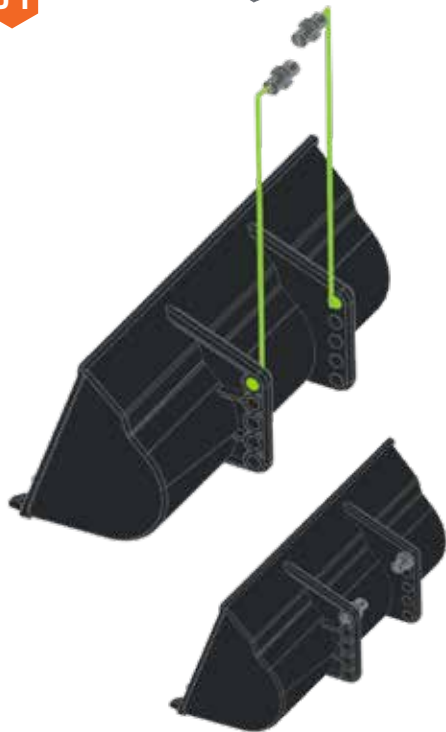

62

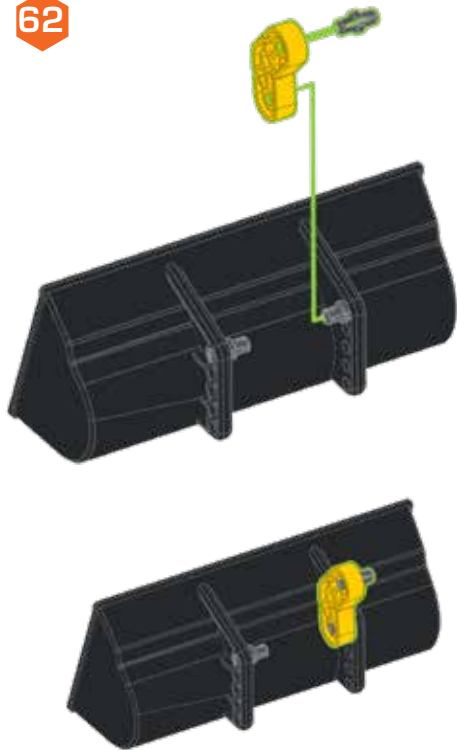

63

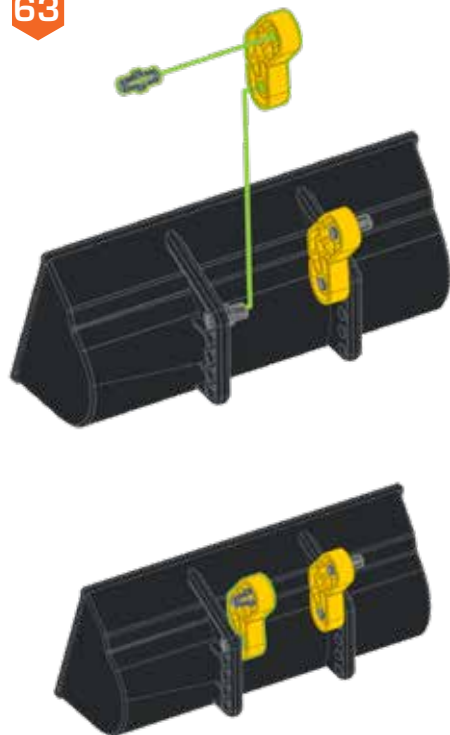

64



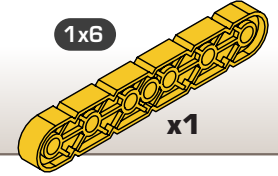
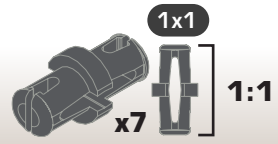
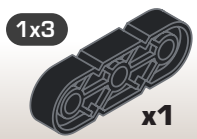
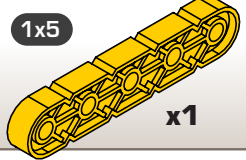

65

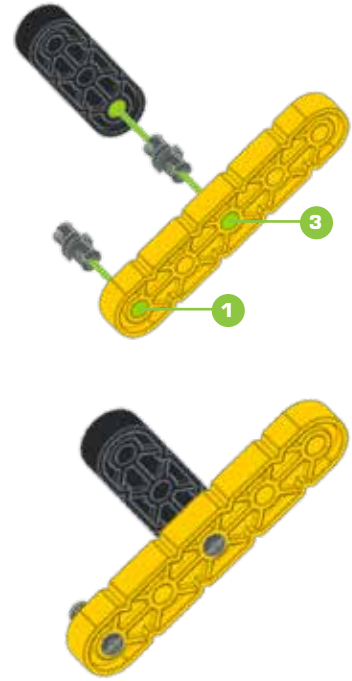

66

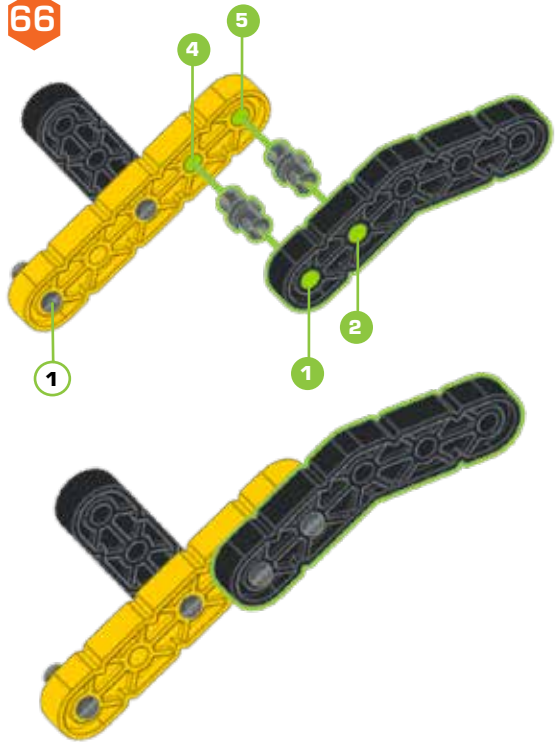

67

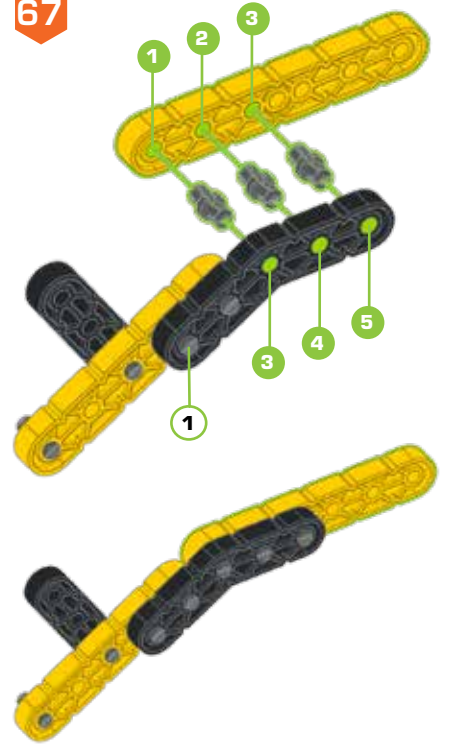

68





x2



x1

3x

1:1

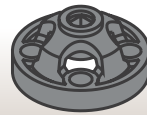

x2

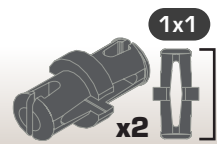

x2

1:1

69



70

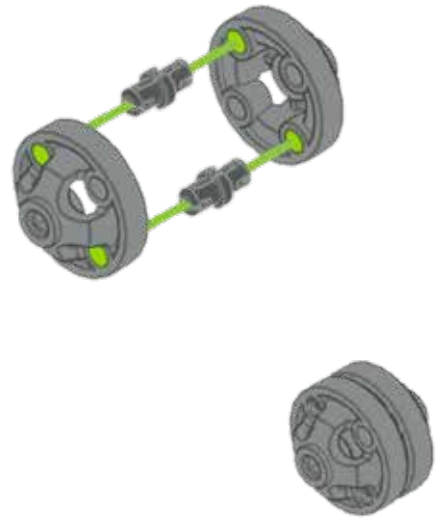

1





2

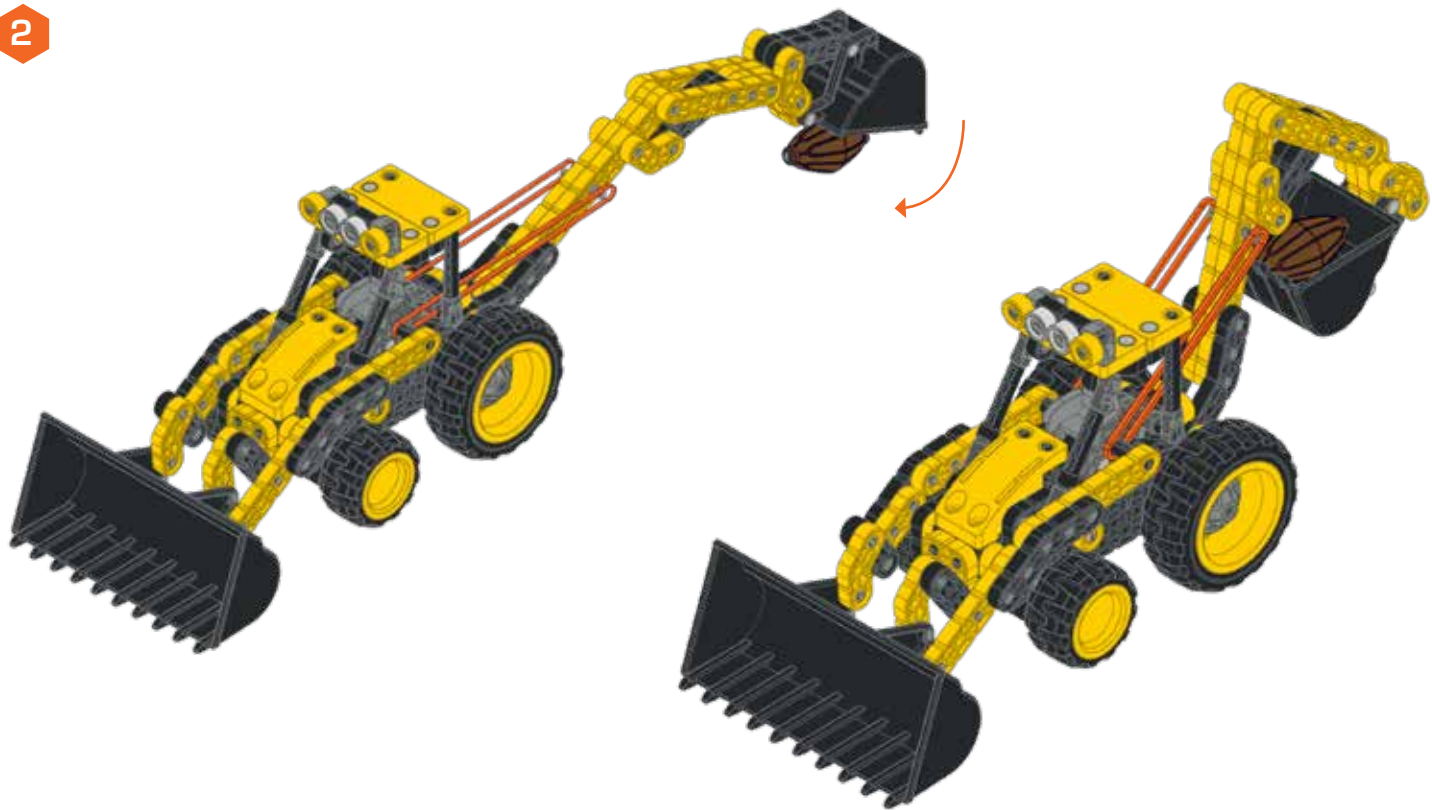

HEXBUG® and VEX® are registered trademarks of/ sont des marques de commerce de/son marcas comerciales de/ ist ein eingetragenes Warenzeichen von/ è un marchio registrato di/jest zastrzeżonym znakiem towarowym firmy/ on rekisteröity tuotemerkki/är ett registrerat varumärke för/er et registreret varemærke tilhørende/ er et registreret varemærke tilhørende/ 赫資®和VEX®是創首國際的註冊商標 Innovation First, Inc./ The item inside this package may vary from the photographs and/or illustrations. Please retain package for future reference. Please remove all packaging material before giving to children. This product conforms to the safety regulations. Made and assembled in China. Do not put toy in mouth./ L'objet dans cet emballage peut différer des photographies et/ou des illustrations. Veuillez conserver cet emballage pour consultation ultérieure. Enlevez tout l'emballage avant de donner le jouet à des enfants. Ce produit est conforme aux normes de sécurité. Fabriqué et assemblé en Chine. Ne pas mettre le jouet dans la bouche./ El artículo dentro de este empaque puede variar de las fotografías y/o ilustraciones. Conserve este empaque para futuras referencias. Retire todo el material de empaque antes de dar el juguete a los niños. Este producto cumple con las normas de seguridad. Fabricado y ensamblado en China. No se ponga el juguete en la boca. / Der in dieser packung enthaltene artikel kann von den fotos und/oder abbildungen abweichen. Bitte bewahren sie die verpackung auf, damit sie später ggf. auf diese information zurückgreifen können. Entfernen sie sämtliche verpackungsmaterialien, ehe sie das spielzeug einem kind aushändigen. Dieses produkt entspricht den sicherheitsbestimmungen. Hergestellt und zusammengebaut in china. Das spielzeug nicht in den Mund stecken./ L'articolo all'interno della confezione può non essere identico alle fotografie e/o illustrazioni. Conservare la confezione per riferimento futuro. Rimuovere tutti i materiali da imballaggio prima di consegnare a bambini. Questo prodotto è conforme alle norme di sicurezza./ Non mettere il giocattolo in bocca / przedmiot wewnątrz opakowania może różnić się wyglądem od zdjęć i/lub ilustracji. Proszę zachować opakowanie jako źródło informacji na przyszłość. Proszę wyjąć produkt z opakowania przed oddaniem go dziecicom. Produkt spełnia normy bezpieczeństwa. Valmistettu ja koottu kiinassa / tämän pakkauskesän sisällä oleva tuote voi poiketa valokuvista ja/tai kuvista. Säilytä pakkaus telineä tarvetta varten. Poista kaikki pakkausmateriaalit ennen tuotteen antamista lasten käsiin. Tämä tuote noudattaa turvallisuusmääräyksiä. Tilverkad / Tilverkad / produkten i denna förpackning kan skilja sig från fotografier och/eller illustrationer. Spara förpackningen för framtida referens. Avlägsna allt förpackningsmaterial innan produkten ges till barn. Produkten följer säkerhetsbestämmelserna. Laget og monteret i Kina./ elementet i denne pakke kan variere fra fotografier og/eller tegninger. Gem venligst pakken til fremtidig referens. Fjern al emballage før enheden gives til børn. Dette produkt opfylder sikkerhedsforskrifterne. Fabricado e montado na china./圖片僅供參考。請保留包裝備用。請拆除所有包裝再給小朋友。本產品符合安全要求。中國製造與。Firma - 不可將玩具放入嘴中。/ Copyright © 2020 Innovation First, Inc. All Rights Reserved/ Tous droits réservés/ Todos los derechos reservados/ Alle Rechte vorbehalten/ Tutti i diritti riservati/ Wszystkie prawa zastrzeżone./ Kaikki oikeudet pidätetään./ Alla rättigheter förbehålles./ Alle Rettigheter Reservert./ Alle rettigheder forbeholdes./版權所有。For information concerning Hexbug's Limited Warranty-- www.hexbug.com/policies; For customer service in your region go to: www.hexbug.com/contact / Pour plus d'informations sur la garantie limitée de Hexbug -- www.hexbug.com/policies; Pour le service client de votre région, rendez-vous sur : www.hexbug.com/contact / Pour plus d'informations sur la garantie limitée de Hexbug -- www.hexbug.com/policies; Pour le service client de votre région, rendez-vous sur : www.hexbug.com/contact / Para obtener información sobre la garantía limitada de Hexbug visite: www.hexbug.com/policies; Para comunicarse con el servicio al cliente de su región visite: www.hexbug.com/contact / Informationen zur eingeschränkten Garantie von Hexbug finden Sie unter: www.hexbug.com/policies; Den Kundendienst in Ihrer Region finden Sie unter: www.hexbug.com/contact / Per informazioni sulla garanzia limitata offerta da Hexbug-- www.hexbug.com/policies; Per il servizio clienti nella propria regione visitare: www.hexbug.com/contact / Per informazioni sulla garanzia limitata offerta da Hexbug-- www.hexbug.com/policies; Per il servizio clienti nella propria regione visitare: www.hexbug.com/contact / Informacje na temat ograniczonej gwarancji Hexbug znajdziesz na stronie www.hexbug.com/policies; Informacje na temat obsługi klienta w Twoim regionie znajdziesz na stronie: www.hexbug.com/contact / Lisätietoja Hexbugin rajoitetusta takuusta: www.amo.fi; Jos haluat asiakaspalvelua alueellasi, siirry osoitteeseen: www.amo-toys.com / För information om Hexbug's Begränsad garanti-- www.hexbug.com/policies; För kundtjänst i din region gå till: www.amo-toys.com / For information om Hexbug's begrænsede garanti-- www.hexbug.com/policies; For kundeservice i din region, gå til: www.amo-toys.com / For information vedgørende Hexbug's Begrænset Garanti-- www.hexbug.com/policies; For kundeservice i dit område gå til: www.amo-toys.com / 關於赫資質量保證信息--請訪問 www.hexbug.com/policies; 關於售後客服,請訪問: www.hexbug.com/contact Custom manufactured in / Fabriqué sur mesure en / Fabricado a medida en / Hergestellt in / Prodotto in / Op maat gefabriceerd in / Fabricado a medida na / Wykonane na zamówienie w / Mittitalaustyönä valmistettu/ Tilverkad i / Spezialproduzent i / Spezialfremstillet i/ 定制生產於 China For Innovation First Trading SARL. Distributed in the U.S.A. by / Distribuë aux états-unis par / Distribuido en los EE. UU. por / Vertrieben in den USA durch / Distribuito negli U.S.A. da / Gedistribueerd in de VS door / Distribuido nos EUA pela / Dystrybuowane w USA przez/ Jaettu USA: ssa/ Distribueras i USA av/ Distribuert i USA av/Distribueret i USA av/ 美國地區經銷商 Innovation First Labs, Inc., 6725 W. Fm 1570, Greenville, Texas 75402, U.S.A. Distributed in Europe by / Distribuë en Europe par / Distribuido en Europa por / Vertrieben in Europe durch / Distribuito in Europe da / Gedistribueerd in Europe door / Distribuido na Europe pela / Dystrybuowane w Europie przez/ Maahantuja Euroopassa/ Distribueras i Europa av/ Distribueret i Europa av/ Distribueret i Europa av/ 歐洲地區經銷商 Innovation First Trading SARL, Parc Logistique Eurohord Sud L-3434 Dudelange Luxembourg +352 27 86 04 87. Distributed in Canada by / Distribuë au Canada par / Distribuido en Canada por / Vertrieben in Canada durch / Distribuito in Canada da / Gedistribueerd in Canada door / Distribuido no Canadá pela / Dystrybuowane w Kanadzie przez/Jaettu Kanadassa/ Distribueras i Kanada av/ Distribuert i Canada av/ Distribueret i Canada av/ 加拿大地區經銷商 Innovation First Trading, Inc., 6725 W. Fm 1570, Greenville, Texas 75402, U.S.A. www.hexbug.com/contact Maahantuja Suomessa / Importör i Finland/ Ansatie 5, 01740 Vantaa/Vanda, www.amo.fi, Kuluttajpalvelu/ Konsumentenservice Suomi +358 20163 0530/ Importör i Sverige, Norge, Danmark: AMO Toys AB, Garnisonsgatan 10, 25466 Helsingborg, www.amo-toys.com. Konsumentenservice Sverige +46 722026142 / Kundeservice Norge +47 46520501 / Kundeservice Danmark +45 72170187 PLEASE KEEP THESE INSTRUCTIONS. Please keep these instructions./Veuillez conserver le mode d'emploi./Por favor conserve la guía de instrucciones./Diese Anleitung bitte aufbewahren./Conserve ueste istruzioni./ Proszę zachować niniejszą instrukcję./ Säilytä nämä ohjeet. / Spara instruktionerna./ Vennligst ta vare på disse instruksjonene. / Gem brugsanvisningen. 請妥善保管說明書



**Warning:** CHOKING HAZARD – Small parts. DO NOT put in nose or mouth.  
**Avertissement:** RISQUE D'ASPHYRIE – Ce produit contient de petits éléments. NE PAS mettre dans la nez ou la bouche.  
**Advertencia:** RIESGO DE ASFIA – Contiene piezas pequeñas. No lo meta en la nariz o la boca.  
**Achtung:** ERSTICKUNGSGEFAHR – Kleinteile. NICHT in die Nase oder den Mund geben.  
**Attenzione:** RISCHIO DI SOFFOCAMENTO – Pezzi piccoli. Non mettere nel naso o nella bocca.  
**Ostrzeżenie:** NIEBIEZPIECZNIWO ZADRWAENIA – małe części. NIE WOLNO wkładać do nosa ani do ust.  
**Varoitus:** TUKEHTUMISVAARA – Pieniä osia. ÄLÄ laita nenään tai suuhun.  
**Varoitus:** KÄVÄLINGSSRIK – små delar. LÄGG INTE i näsa eller mun.  
**Advarsel:** KVELNINGSSFARE – Små deler. MÅ IKKE puttes i nese eller mund.  
**Advarsel:** KVELNINGSSFARE – Små deler. Indsæt IKKE i næse eller mund.  
**警告:** 誤食哽噎的危險--小零件。請勿放入鼻子或嘴中。



<p><b>WARNING:</b> CHOKING HAZARD-Small parts. Not for children under 3 years.</p>	<p><b>AVERTISSEMENT:</b> RISQUE D'ÉTOUFFEMENT- Comporté de petites pièces. Ne convient pas aux enfants de moins de 3 ans.</p>	<p><b>ADVERTENCIA:</b> RISGO DE ASFIA- Pequeñas partes. No para niños menores de 3 años.</p>
<p><b>ACHTUNG:</b> ERSTICKUNGSGEFAHR- Kleinteile. nicht für Kinder unter 3 Jahren</p>	<p><b>ATTENZIONE:</b> RISCHIO DI SOFFOCAMENTO- Piccole parti. Non adatto a bambini sotto i 3 anni</p>	<p><b>OSTRZEŻENIE!</b> NIEKOPYDZIAŁAWIENIA- Małe części. Niezgodownie dla dzieci poniżej 3 roku życia.</p>
<p><b>VAROITUS:</b> TUKEHTUMISVAARA- Pieniä osia. Ei alle 3-vuotiaalle lapselle.</p>	<p><b>VARNING:</b> KÄVÄLINGSSRIK- Små delar. Inte avsett för barn under 3 år.</p>	<p><b>ADVARSEL:</b> KVELNINGSSFARE- Små deler. Ikke for barn under 3 år.</p>
<p><b>FORSIGTIG:</b> RISIKO FOR KVELNING- Små dele. Ikke egnet til børn under 3 år.</p>	<p><b>警告:</b> 誤食哽噎的危險-小零件。不適用於三歲以下兒童。</p>	

HEXBUG®

# VEX® ROBOTICS



[HEXBUG.COM/VEX](http://HEXBUG.COM/VEX)

 Backhoe  
406-7094  
LOT #

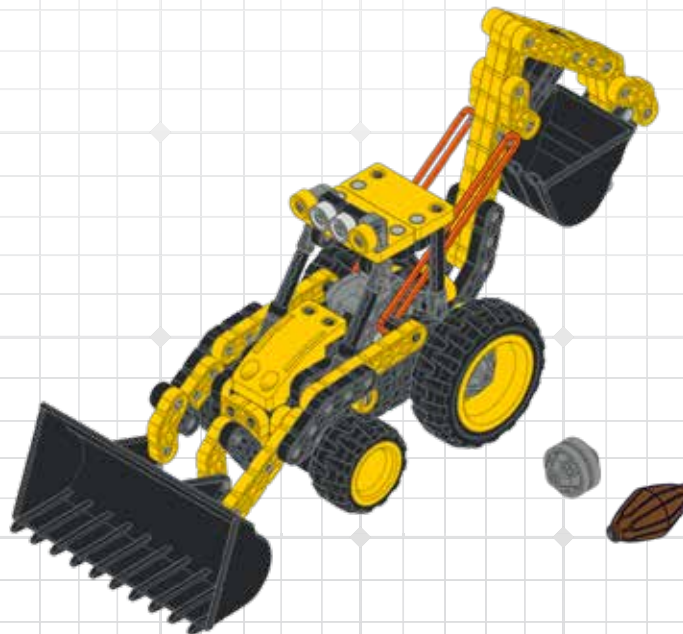

**VEX**<sup>®</sup>

ROBOTICS

NEED HELP? / NECESITAS AYUDA? / BESOIN D'AIDE? / SERVE AIUTO?? /  
HILFE? / POTRZEBUJESZ POMOCY? / TARVITSETKO APUA? / BEHÖVER DU HJÄLP? / TRENGER  
DU HJELP? / BRUG FOR HJÆLP? / 需要幫助?

**WWW.VEX.COM/HELP**