

# PIPER J-3 Cub GP/EP



## **SPECIFICATIONS**

WING SPAN :1720mm

LENGTH:1095mm

WING AREA:42dm<sup>2</sup>

WEIGHT:2300-2600g

RADIO:4 CHANNELS

ENGINE: .46(2C) .56(4C)

## **Warning**

An RC aircraft is not a toy! If misused, it can cause serious bodily harm and damage to property. Fly only in open areas, following all instructions included with your radio.

Before beginning the assembly, remove each part from its bag for inspection. Closely inspect the fuselage, wing panels, rudder and stabilizer for damage. If you find any damaged or missing parts, contact the place of purchase.



Contents of Kit / Parts Layout

**Recommended radio and equipment (not included in kit):**

4 channels radio x 1 piece  
 Receiver x 1 piece  
 45g servo x 4 pieces  
 30cm extension x 1 pieces  
 Switch x 1 piece  
 Engine: 46(2C)c~56(4C)  
 Aluminum spinner (for Gas engine)  
 4.8V battery

**For EP:**

Motor: 500~680KV  
 Battery: 2200~3000mAh 4-cell Li-Po  
 ESC: 50-60A  
 Propeller: 11x6" ~12x6"  
 Aluminum spinner (for EP flying)

**Tools and suppliers needed (not included in kit):**

Phillips screws driver #0/#1 / Curved scissors  
 Hex wrench 1.5/2mm/2.5mm/6mm / Hobby knife / Ruler / Iron / Cross wrench  
 Pliers / Z-bender / Sanding paper / Epoxy 5-10 minutes / Marker / CA glue  
 UHU foam glue / Superglue / Cross wrench / Reamer / Solder Iron  
 Thread lock / Side Cutter / Driller 2mm/6mm / Transparent Tape / Pin  
 3M fiber tape

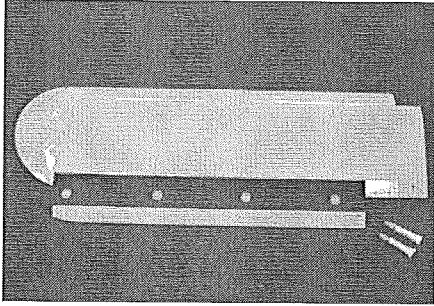

Place the main wing and hinges on the working table.

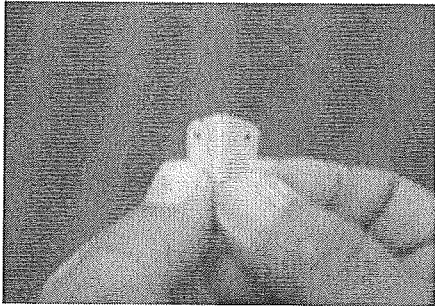

Bend the hinges several times. Spread the Super glue on the hinges and insert into the hinges slot on the main wing and aileron. Apply the tape to hold the aileron in position temporary until the glue dry enough.

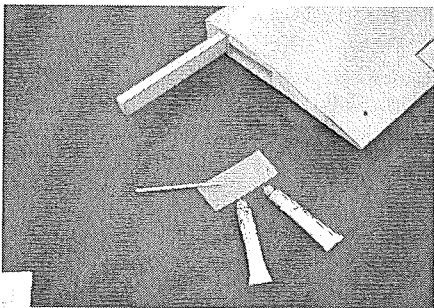

Try to fit the wing joiner into the main wing. If too tight, use sand paper to trim the wing joiner. When satisfy the assembly, use pencil to mark the location of the servo tray.

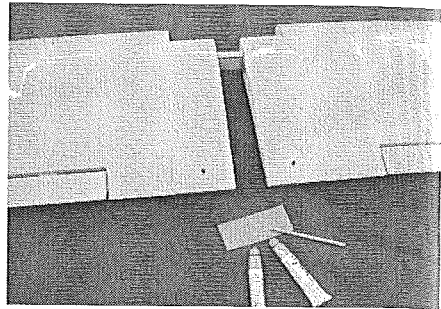

Mix 10-min epoxy and spread generous amount of epoxy on the wing joiner. Fit the wing joiner into the main wing. Apply tape on the conjunction temporary until the epoxy dry enough.

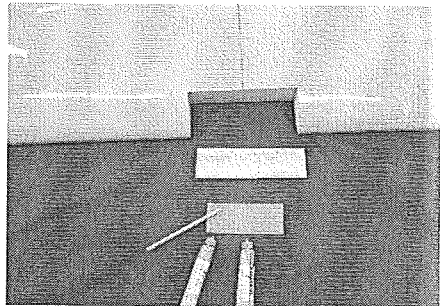

Take the main wing front planking out of the wooden hardware bag. Spread epoxy on the planking and secure on the main wing.

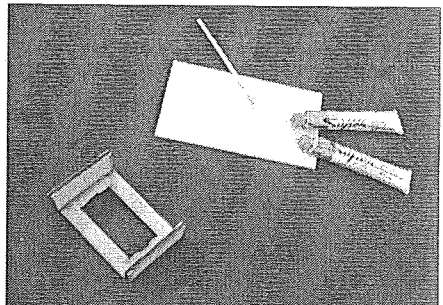

Place the main wing servo tray on the working table. Use epoxy to secure two sides of planking on the tray.

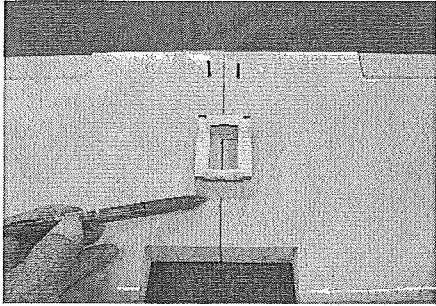

Place the servo tray on the center of the main wing set. Use marker to mark the location of the servo tray on the main wing.

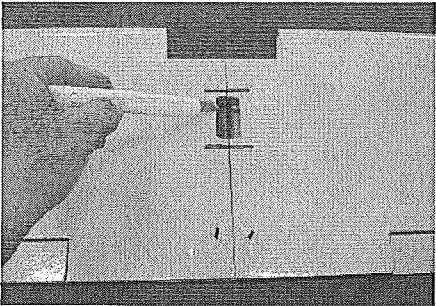

Use hobby knife to remove the covering over the hole.

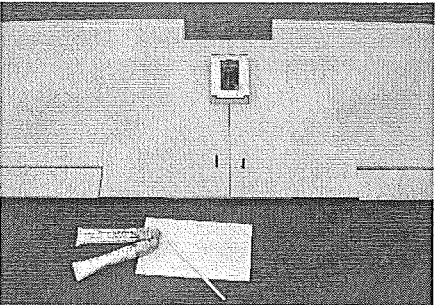

Use epoxy to secure the servo tray in position.

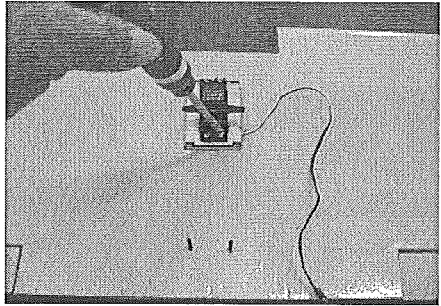

Place the servo on the servo tray and secure it in place with the screws come with the servo.

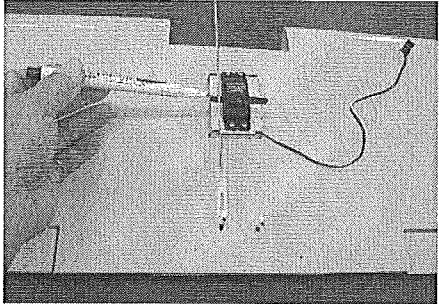

Take two pieces of 330mm rods out of the hardware bag. Use side cutter to cut all the parts out of the plastic parts tree. Screw a clevis onto the threaded end of each rod. Thread the aileron horns onto the aileron torque rods in the wing until the rod is flush with the aileron horn. Attach the clevises onto their respective aileron horns. Center the aileron servo and using marker to place a mark on the unthreaded end of the aileron pushrods where they pass their respective servo arm.



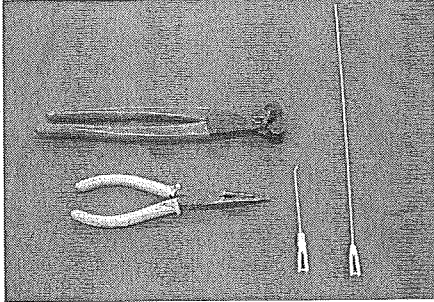

Using z-bend pliers, make a z-bend at the marked location on each rod and cut off the excess rod.

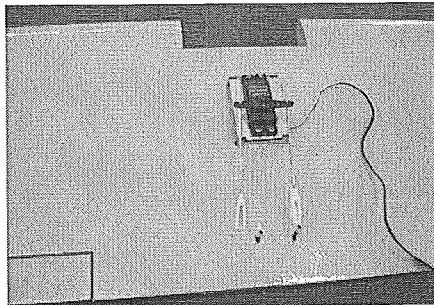

Use 2mm reamer to enlarge the hole on the servo arm. Place a piece of fuel tubing over the clevises. This will provide extra insurance against the clevises accidentally coming open. Install the z-end into the hole of the servo arm. Adjust the aileron torque rod length by screwing in or out until the aileron is exactly in the neutral position when the servo is centered and clevis is in the aileron horn. Adjust both sides.

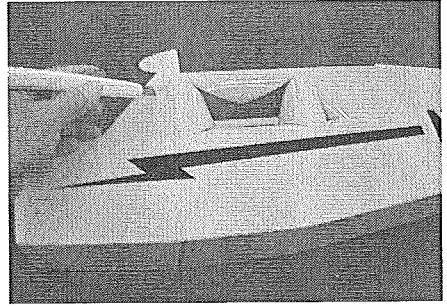

Find the pre-serving opening on both sides of the fuselage for assembling windows. Use hobby knife to remove the covering over the openings. Please reserve 6mm covering on the edges of the openings.

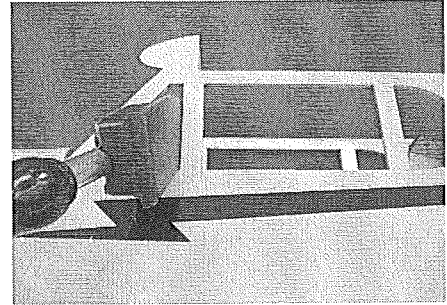

Use iron (140°C) to trim the edges, and use hobby knife to remove the excess covering.

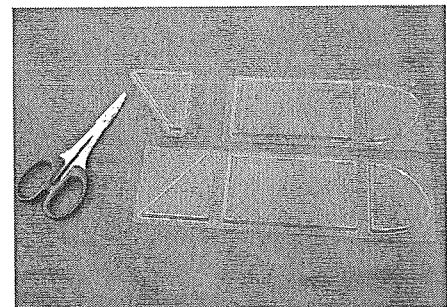

Place the window set on the working table and use curved scissors to remove window from the window set. Please reserve 6mm on the edges. Spread UHU glue along the edges of

window set and secure on the fuselage. Apply tape on the window set for holding it in place until the glue is dry enough.

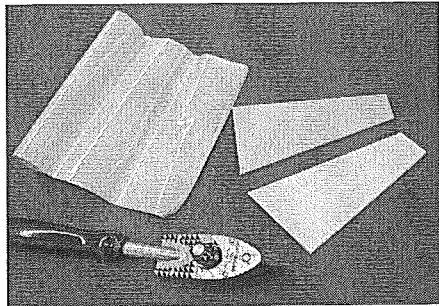

Place the yellowing covering and main gear planking on the working table. Iron on the covering onto the main gear planking.

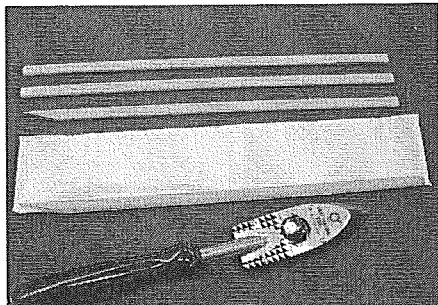

Iron on the covering onto the wing struts and the triangle reinforcing planking.

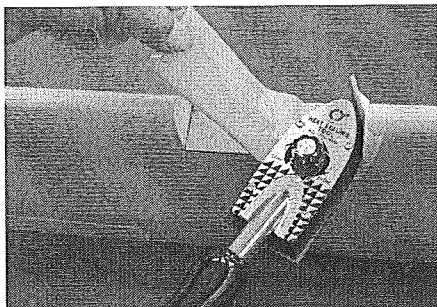

Iron on the covering onto the front edge of the main wing.

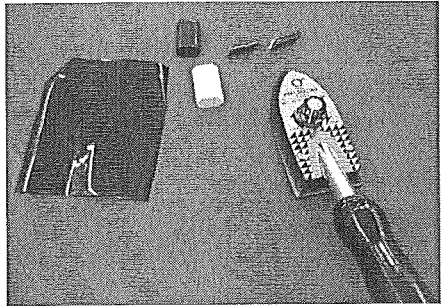

Place the black covering, decorative muffler and spring on the working table. Iron on the black covering onto the muffler and spring. Please note there is a hole on the center part of the spring. Use reamer to re-open the hole after ironing.

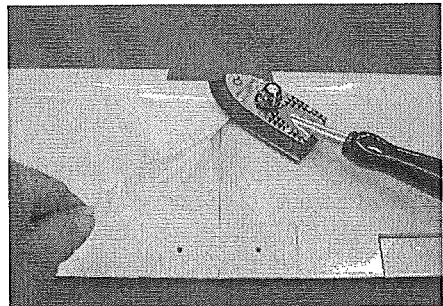

Find a long trip of yellow covering in the hardware bag. Iron on the yellowing covering onto the conjunctions.

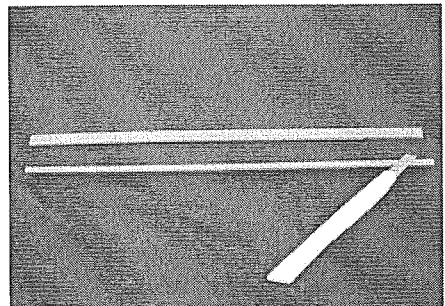

Try to fit two struts together and use hobby to remove the covering on the conjunctions.

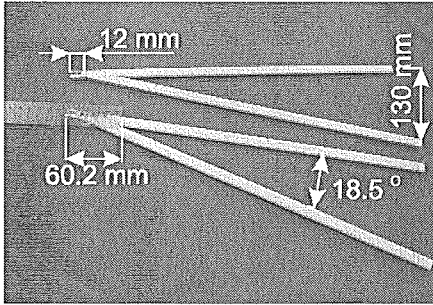

Use epoxy to glue the struts together and use tape to secure the struts temporary.

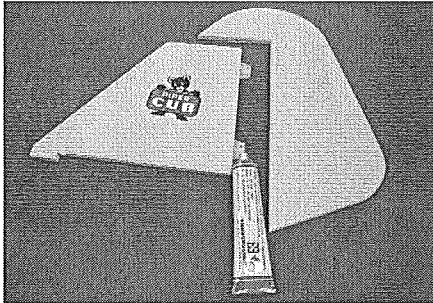

Spread generous super glue on the hinges and insert the hinges into the rudder until the hinge line is even with the leading edge of the rudder. Place the rudder onto the vertical stabilizer.

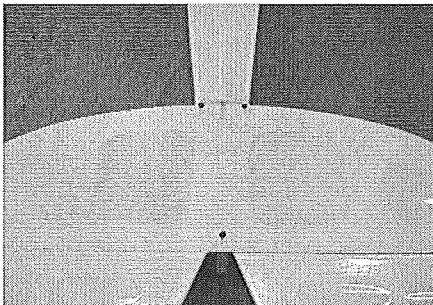

Place the horizontal stabilizer on the working table. Use ruler to mark the center line on the stabilizer. Place the fuselage on the stabilizer. The center line of the fuselage must meet the center line on the stabilizer. Use 3

pieces of needle to fix the stabilizer on the fuselage.

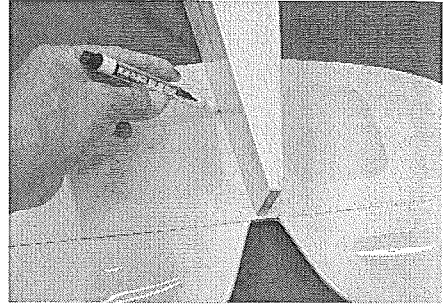

Use a pencil to carefully trace around the bottom and the top of the stabilizer where it meets the fuselage. Remove the fuselage.

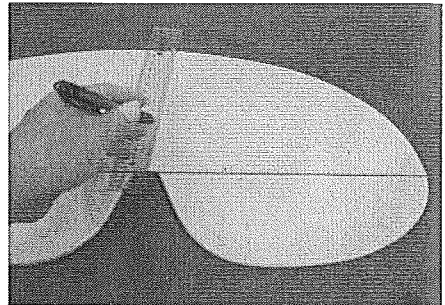

Use a straight ruler to mark the area inside the line.

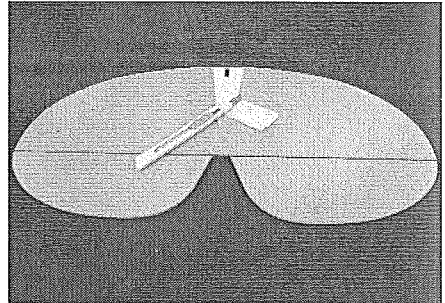

Using a hobby knife carefully cut away the covering inside the lines marked above. Be carefully not to cut into the wood as doing so will weaken the structure.

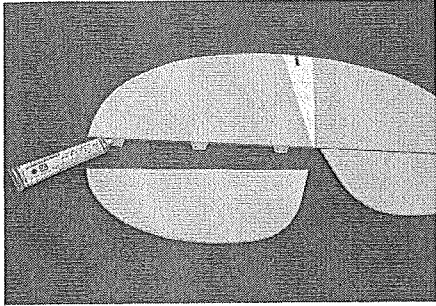

Spread generous super glue on the hinges and insert the hinges into the elevator. Place the elevator onto the horizontal stabilizer.

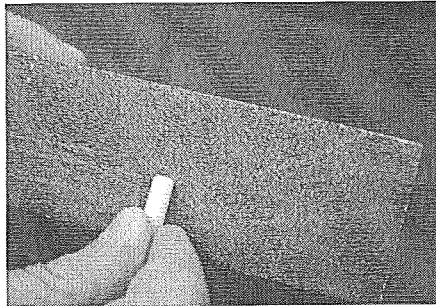

Take 6mm dowels out of the hardware bag. Use sand paper to sand both ends for making 1mm 45 degree angle.



Place the main wing onto the fuselage and secure in place with 4x40mm screws and washers. Use 6mm driller to open the hole on the planking, depth is around 15mm.

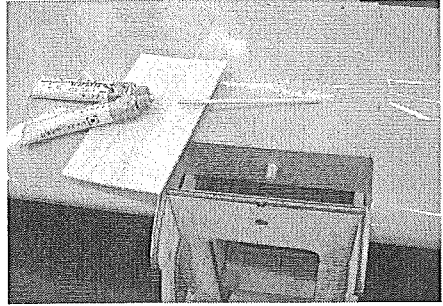

Spread some epoxy on half of the dowel and insert into the main wing.

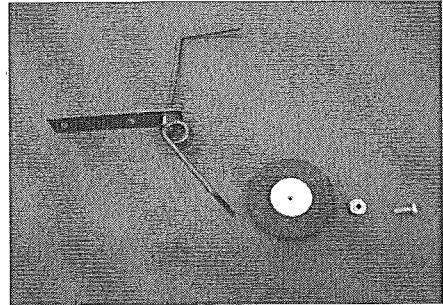

Place the tail wheel and 2mm collar onto the tail gear and secure with 3x5mm screw.

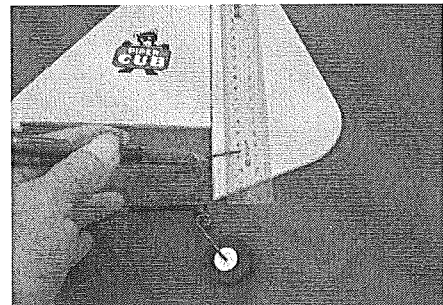

Use ruler to mark a position on the rudder. It is 35 mm from the bottom.



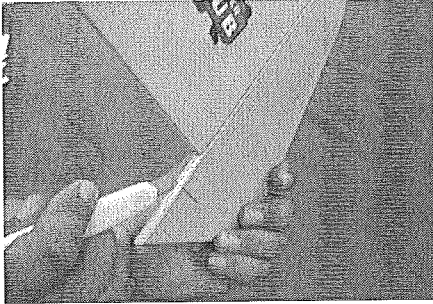

Use a sharp hobby knife to open a V slot (depth: 2mm) on the marked position.

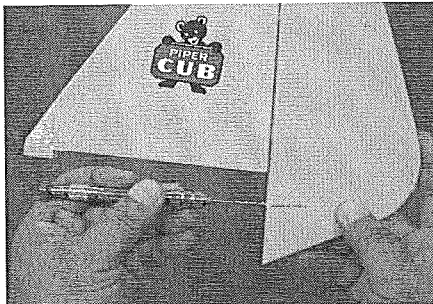

Use 2mm driller to drill a hole on the marked location for accepting the tail wheel guide wire.

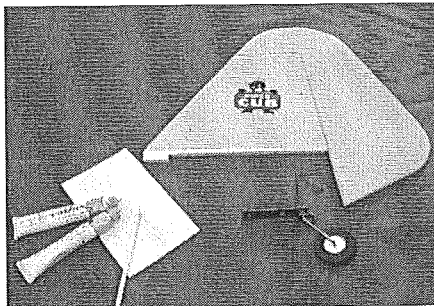

Spread some epoxy into the hole for securing the tail wheel guide wire inside the rudder.



There is a gap between vertical and horizontal on both sides. Try to fit the triangle reinforcement into the gap. Please note it must fit perfect. If not, use sand paper to trim the edges of the reinforcement. When satisfy the location, use pencil to mark the outline on the vertical and horizontal.

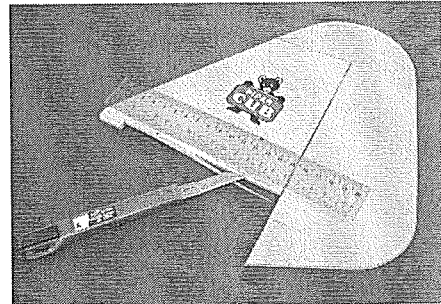

Use hobby knife to remove the covering on the bottom of the vertical.

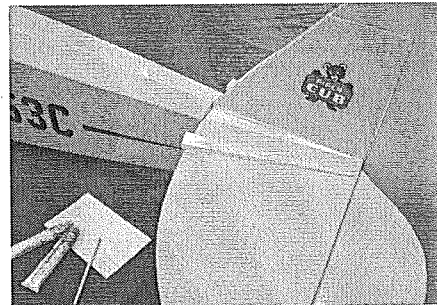

Apply some epoxy the vertical and horizontal where they come in contact with the fuselage. Assemble the vertical and horizontal on the



fuselage. Use needle or tape to hold the vertical in place until it's completely dry.

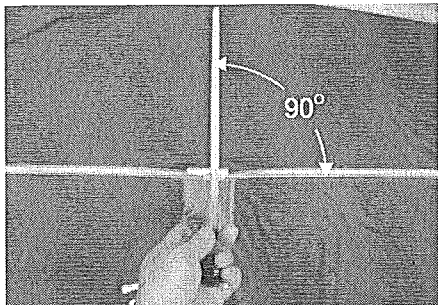

Using a 90 degree triangle, make sure that fin is perpendicular to the horizontal stabilizer.

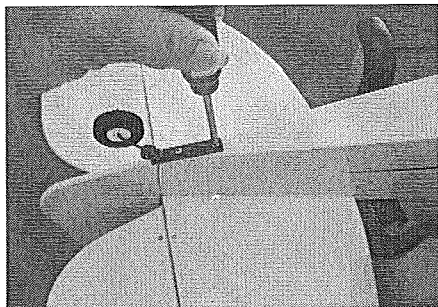

Use 2.6x 10mm tapping screw to secure the tail wheel assembly in location.

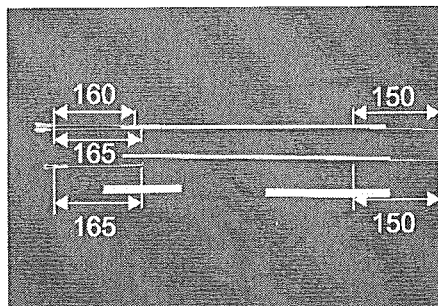

Take dowels, clevis and heat shrink tubing out of the hardware bag. Take a rod of 5mm. Use plier to make a 90 degree bend on no threaded end. Insert the 90 degree bend into the

Hole of the wood dowel. Slide a piece of heat shrink tubing over each end of the wood dowel and shrink it in place using a heat gun.

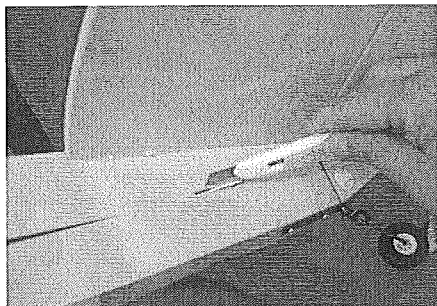

Carefully cut away the covering on the top left side of the fuselage next to the vertical fin for the rudder and the right side for the elevator this is where the pushrods will exit. Position the assembled pushrods through the fuselage to the exit. Slide a piece of fuel tubing and screw the clevis on the end of the pushrod.

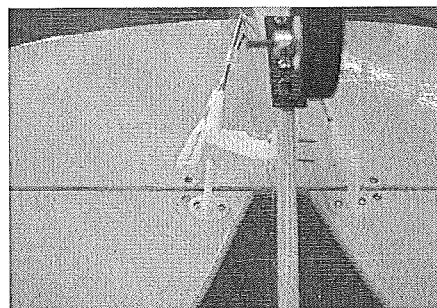

Install the control horns on the elevator and rudder. When installing the control horns, it is important that the holes in the control horns, where the pushrod attaches are directly in-line with the control surface hinge line. Use 2mm drill hole. Secure the control horns and plate in place with 2 x 15mm screws.

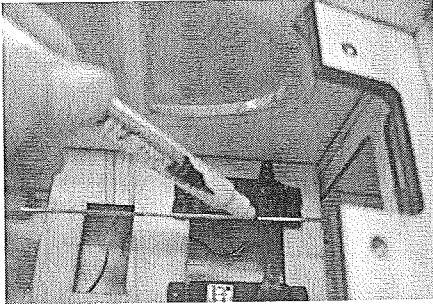

Install the servos on the servo tray and secure with the screws which are included with the servo. Secure the servo tray with epoxy. Center the servo. Using marker to mark the rod where it passes the respective servo arm.

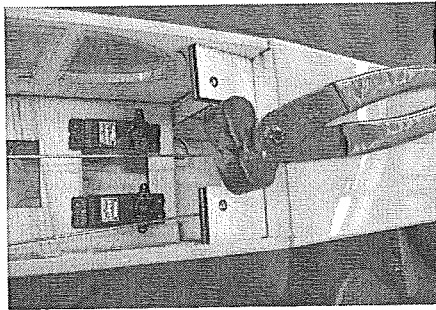

Using Z-bend pliers, make a Z-bend at the marked spot on the rod. Use 2mm drill to open a hole on the servo arm. Insert Z-bend into servo arm and secure with screw. Slide the fuel tubing to the clevis.

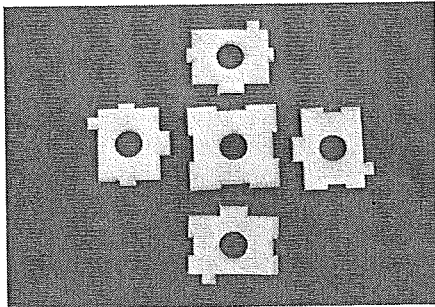

Take the motor mount planking out of

the hardware bag and place on the working table.

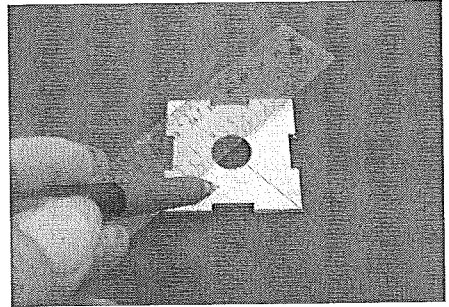

Find two planking that has the same shape. Use epoxy to glue them together. Use ruler to mark a cross on the planking.

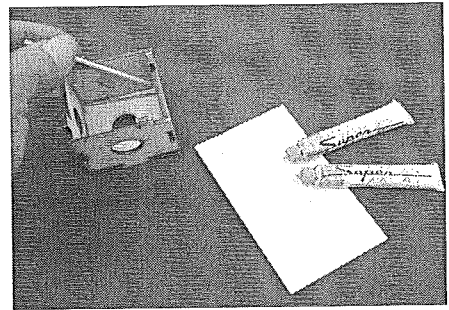

Assemble the planking into the motor mount. Use epoxy to secure the planking in place.

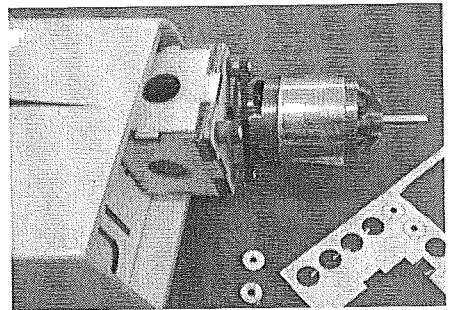

Try to fit the motor on the motor mount. Secure the motor cross plate (come with the motor) on the motor planking with the screws come with

motor. The length of the motor assembly can be adjusted by increasing or decreasing the wooden spacers.

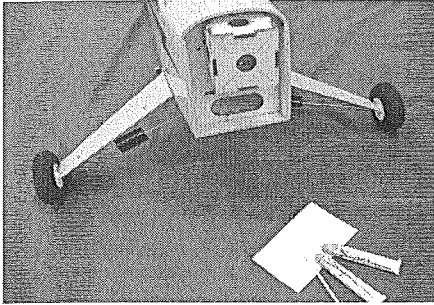

Use epoxy to secure the motor mount on the fire wall.

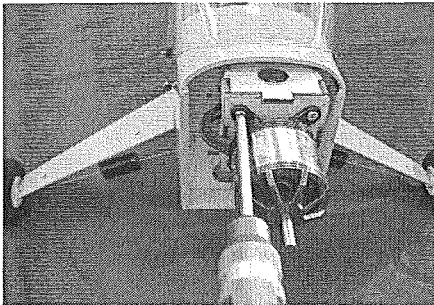

Secure the motor assembly on the motor mount with 3x10mm tapping screws.

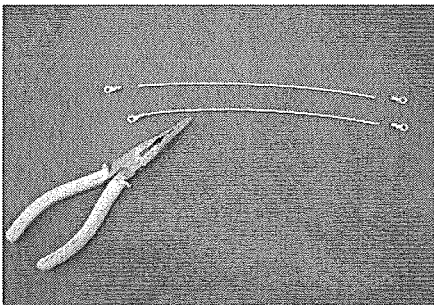

Take the eyelets and wire out of the hardware bag. Use nipple pliers to cut the following sizes of wires:  
220mm x 2 pieces for installing the decorative spring on the main gear.

205mm x 2 pieces for installing on the top of horizontal.

180mm x 2 pieces for installing on the bottom of horizontal.

Insert the end of the wire into the conjunction of eyelet. Use nipple plier to clamp down the conjunction. Drop some instant glue on the conjunction.

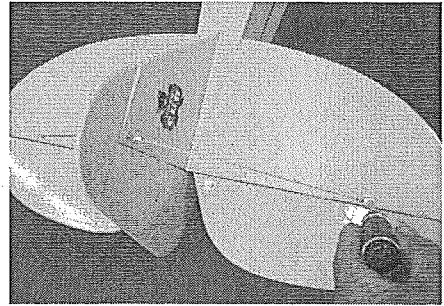

Try to locate the wire assembly on the top of horizontal. One end is 9.5mm from the top of the vertical. The other end is 5mm from the read edge of the horizontal. Please pull the wire straight and use screw and washer to fix it in place temporarily. Don't screw too tight.

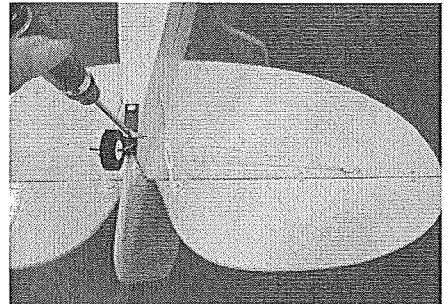

Screw one end of 180mm wire to the bottom of the horizontal and the other end to the tail gear.

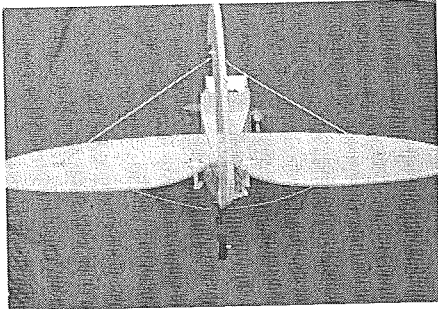

Check all the wires. They must be bilateral symmetry. Screw the screws and washers tight to secure the wires in place.

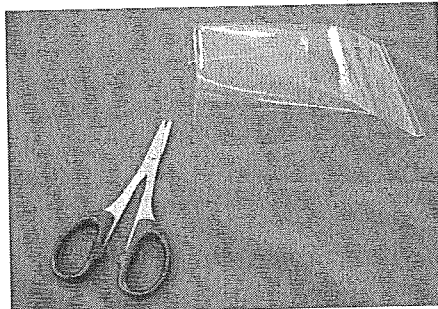

Use curve scissors to trim the canopy according the molding line.

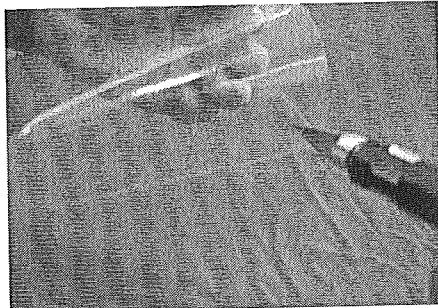

Try to fit the canopy on the fuselage. Use marker to mark the position around 7-8mm from the bottom of the canopy. Use reamer to drill a 5mm hole. Repeat the same procedure on the other side of canopy.

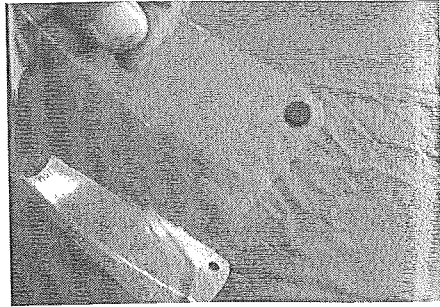

Insert the black rubber ring into the canopy. Please note the canopy must fit into the slot around the rubber ring. It will be easier if drop some water on the ring.

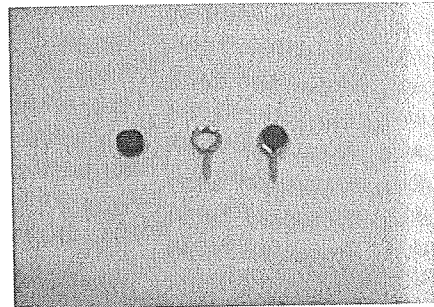

Insert the black rubber ring into the eye screw. Drop some instant screw on the conjunction.

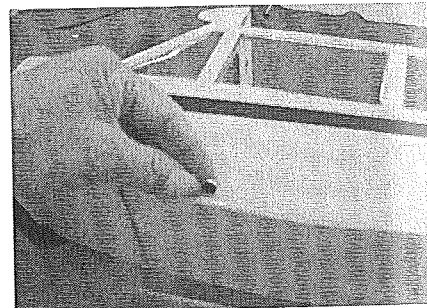

Find a location on the side fuselage. It's 48mm from the gear slot and 8mm from the bottom of the fuselage. Use 1.5mm drill to drill a hole on this location. Screw in the eye screw.



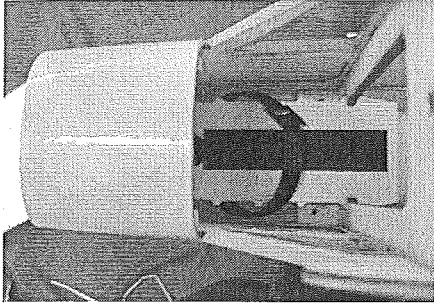

Insert one piece of hook-and-loop strap through the battery tray. Apply one side of Velcro (peel and stick adhesive) on the battery tray.

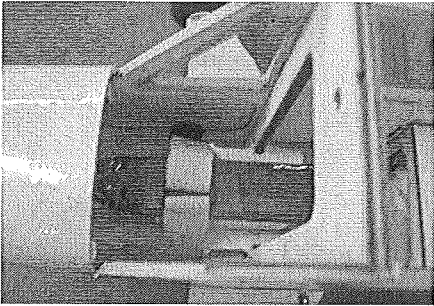

Apply another side of Velcro on the battery. Place the battery on the battery tray and secure in place with hook-and-loop strap.

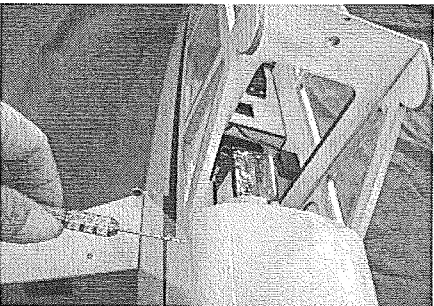

Place the canopy on the fuselage. Apply a piece of tape to fix it in place temporarily. When satisfy the location, use a marker to make a mark on the center of the rubber ring.

Remove the canopy. Use 2mm drill to drill hole on the marked position.

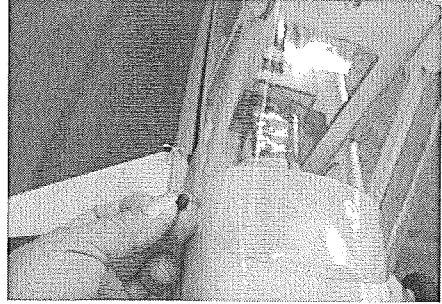

Take M2x15mm screws, washers and nuts out of the hardware bag. Insert a washer to the screw. Place the screw inside the fuselage and insert through the fuselage and canopy. Use washer and nut to secure it in place. Press the rubber ring onto the end. It's convenient for removing the canopy and changing the battery.

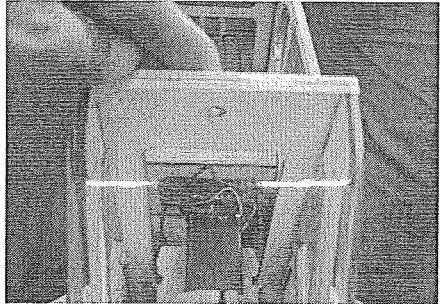

The other side of tape must be press down to fuselage.

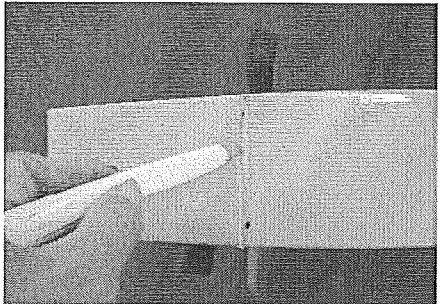



Find the pre-served gear slot on the bottom of fuselage. Use hobby knife to remove the covering on the slot.

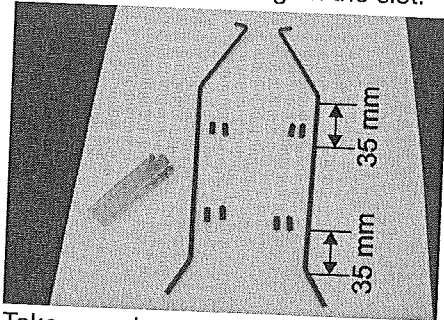

Take one piece of heat shrink tubing out of the hardware bag. Cut the tubing into 5mm x 8 pieces. Please refer to the drawing and note the location for placing the tubing. After heating the first tubing, move the second tubing to over the first tubing and heating again. You can use lighter, heat gun to heating the shrink tube.

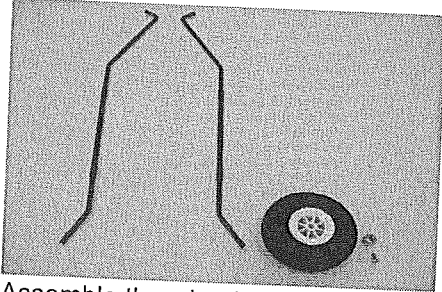

Assemble the wheels on the main gears and secure with 4mm collar and M3x5 screws.

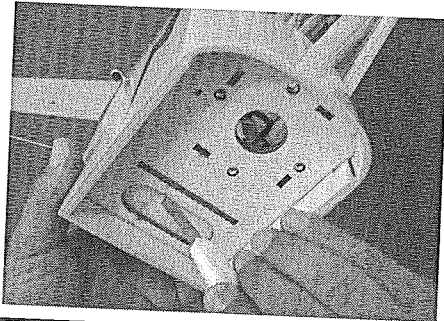

Use sharp hobby knife to remove the planking on the cooling hole.

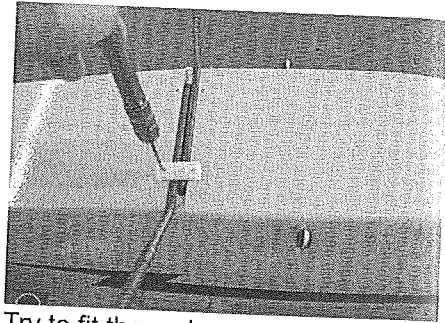

Try to fit the main gears into the gear slot and secure with gear plate and 2.6 x 10mm tapping screws.

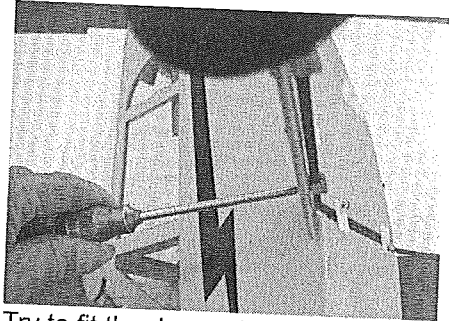

Try to fit the decorative planking on the main gear. Place a saddle cable clip on the main gear where has heat shrink tubing. Use 2.6 x 8mm tapping screw to secure the planking on the gear.

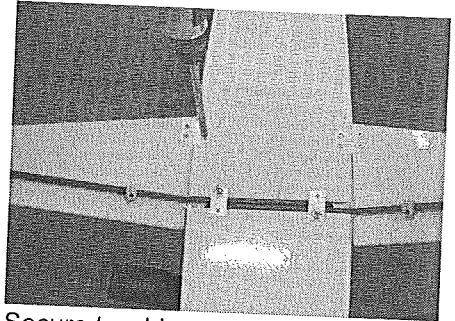

Secure two hinges on the read edge of the gear planking with 2x5mm tapping screws.

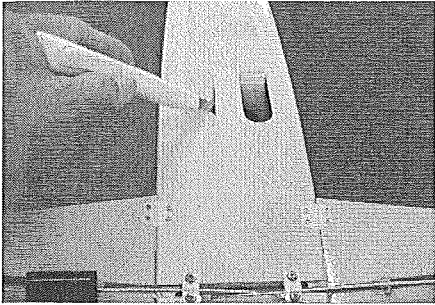

Use hobby to remove the covering over the vent.

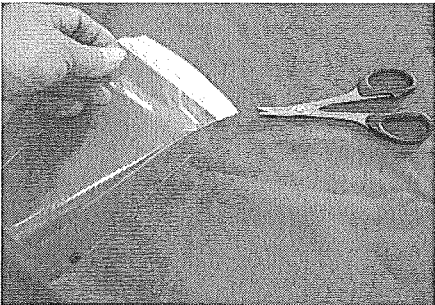

Apply one piece of 30mm 3M fiber tape on the front edge of canopy.

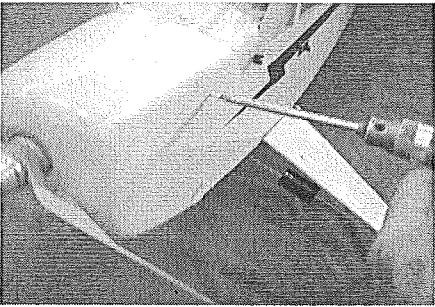

Assemble the motor with propeller and aluminum spinner. Please note there is 1.5mm space between aluminum spinner and cowling. Try to fit the cowling on the fuselage. When satisfy the location, apply a piece of tape to hole the cowling in place. Use 1.5mm driller to drill hole for fixing the cowling on fuselage. Use 2x8mm tapping screws to

secure the cowling in palce.

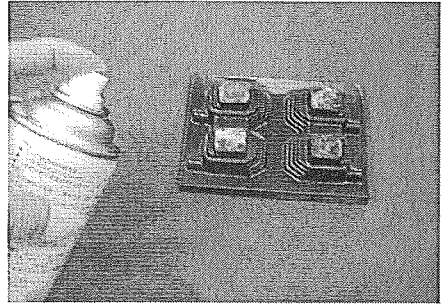

Sprinting black on the decorative plastic engine.

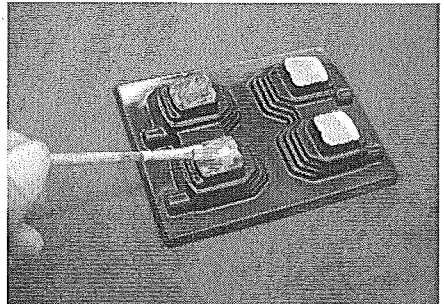

Paint silver on the top of plastic engine.

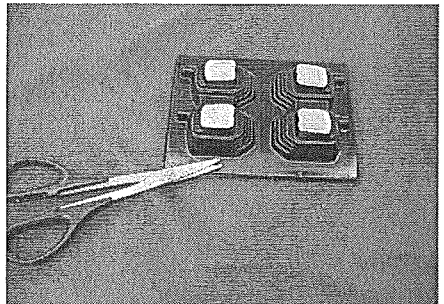

Use curve scissiors to trim the edges. Sand the bottom side.

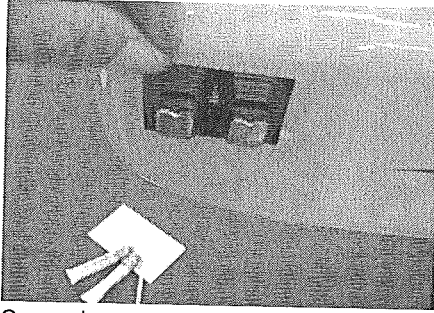

Spread epoxy to secure the plastic engine on two sides of cowling. (It's only one side for GP version.)

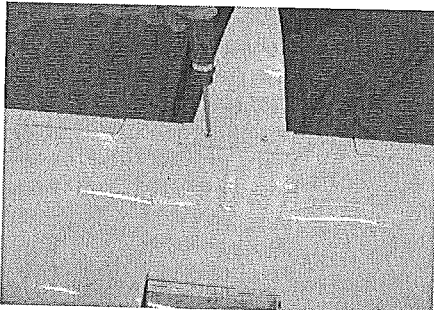

Place the main wing on the fuselage. Screw in the M4x40mm wing bolts.

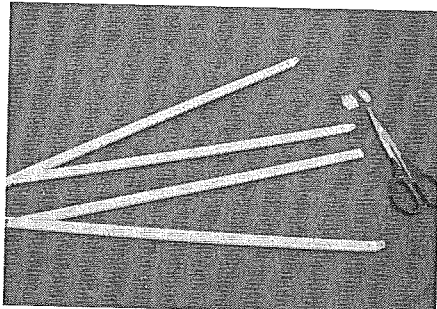

Cut the hinges into two halves. Place one half on the wing struts. Mark the position for fixing the hinges on the struts. Drill 1.5mm hole on the marked position.

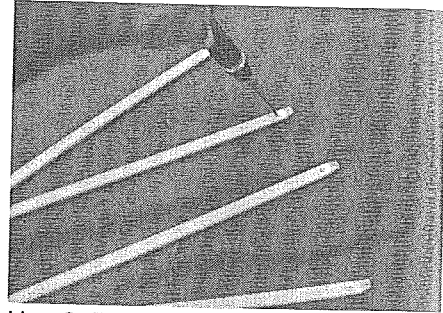

Use 2x5mm tapping screws to secure the hinges on the struts.

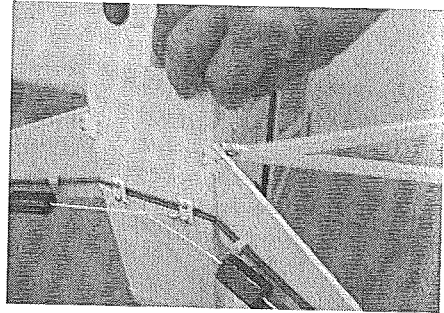

Place the wing struts to the fuselage. Please refer to the picture. The eye screw must be fitted into the slot and fixed with R pin.

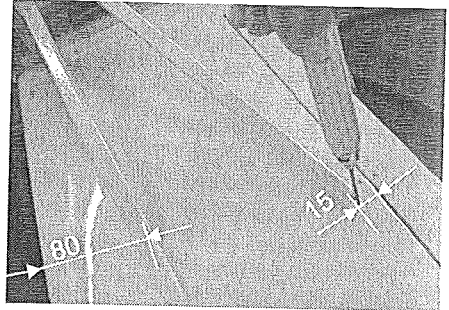

Please refer to the drawing and find the blocks inside the main wing for fixing the struts. Place the struts on the main wing and mark the position for hinges. Drill 1.5mm holes on the marked positions.

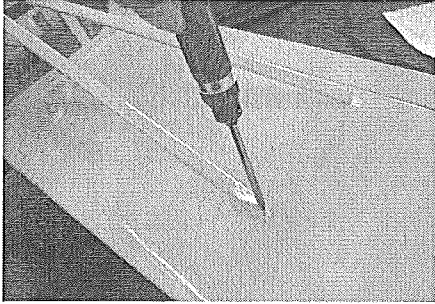

Use 2x8mm tapping screws to secure the hinges in place.

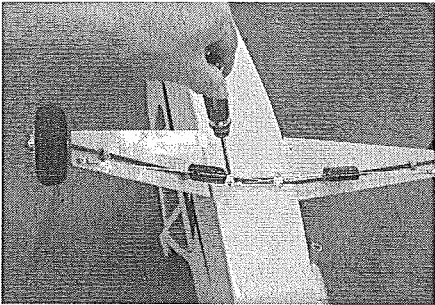

Secure one end of gear wire on the gear fixing plate with 2.6 x 8mm tapping screw. Secure the other end to the gear planking around 7mm from the front edge. Don't pull the wire too tight.

## FOR GP VERSION

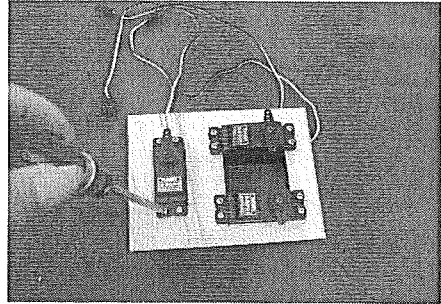

Take the servo tray out of the hardware bag. Place 3 pieces of 45g servos on it and secure with the screws come with the servos. The left servo is for throttle. The top on the right side is for elevator, the bottom is for rudder.

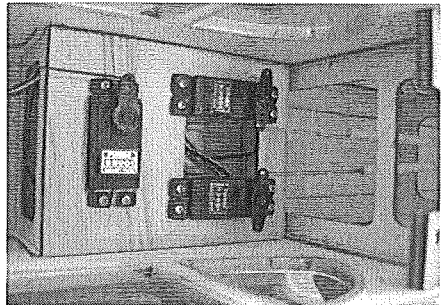

Connect the servo with receiver. Set the horizontal and vertical to neutral position and use clip to hold them in place. Pull the pushrod to the outer hole of servo arm. Using a marker to place a mark on the end of the pushrod where it passes the connection hole of servo horn. Using Z-bend pliers, make a Z-ben at the marked location on the rod. Insert the Z-bend into the servo arm. Adjust the clevis and slide the fuel tube into the rod.

PS: Use epoxy to secure the servo tray on the planking.

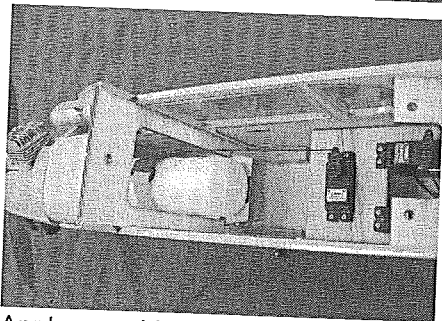

Apply one side of adhesive Velcro on the fuel tank and another side on the battery tray. Connect the fuel tank and pressing hole with fuel tubing. Pull the fuel tube out of the fire wall. The opening for the switch is on the left side. Secure the fuel tank on the battery tray with a hook-and-loop strap.

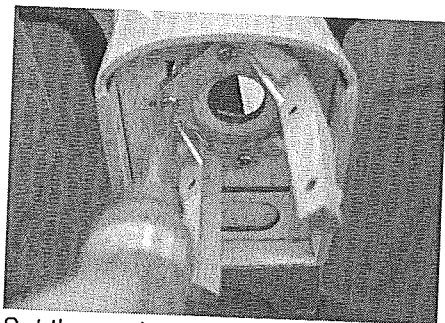

Set the engine mount to 45 degree and secure on the fire wall with M4 x 30mm screws.

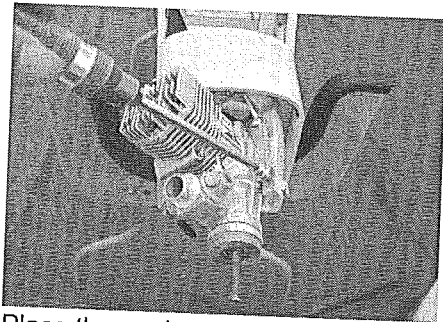

Place the engine on the engine mount. Secure the engine in place

with engine mounting brackets, M4x30mm screws and nuts. Connect with throttle rod. Secure the muffler. Install the fuel tube from the fuel tank pickup line to the carburetor fuel nipple. The vent line will be installed onto the pressure nipple after the muffler is installed.

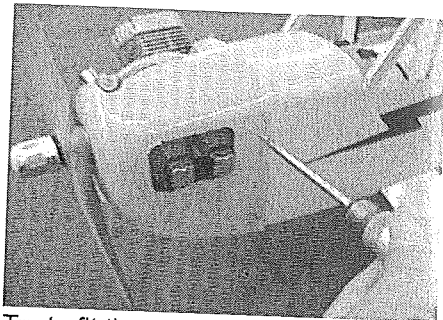

Try to fit the cowling on the fuselage. Use hobby knife to trim the opening for the engine. Please keep 1.5mm space between the cowling and engine mounting brackets. Apply tape to fix the cowling in place temporarily. Use 1.5mm drillers to drill holes on the cowling. Secure cowling in place with 2x8mm tapping screws. Remove the tape. (You may apply tape around the canopy for avoiding the oil during flying.)

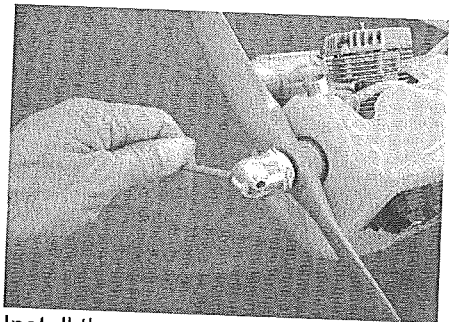

Install the propeller and secure the aluminum spinner.



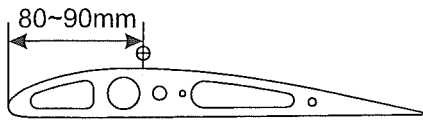

The C.G. Point is 80~90mm back from the leading edge against the fuselage.

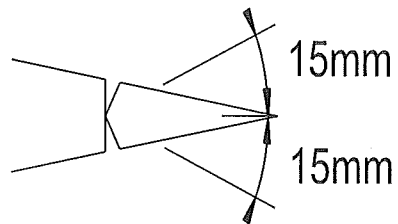

AILERONS THROW

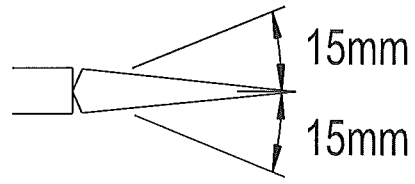
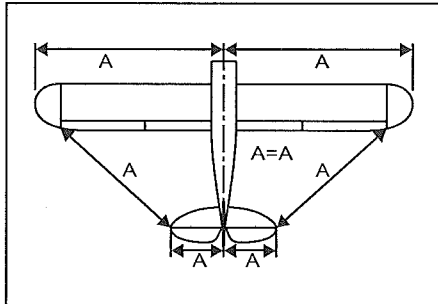

ELEVATOR THROW

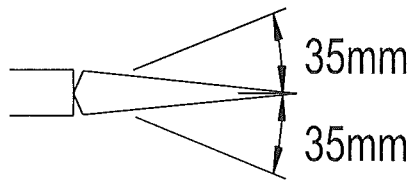
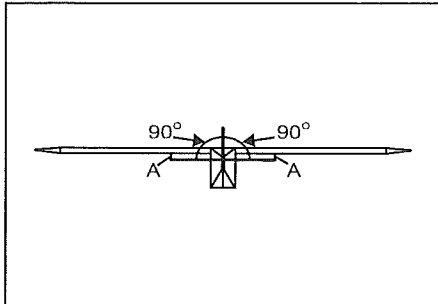

RUDDER THROW

# FOR THE EP VERSION

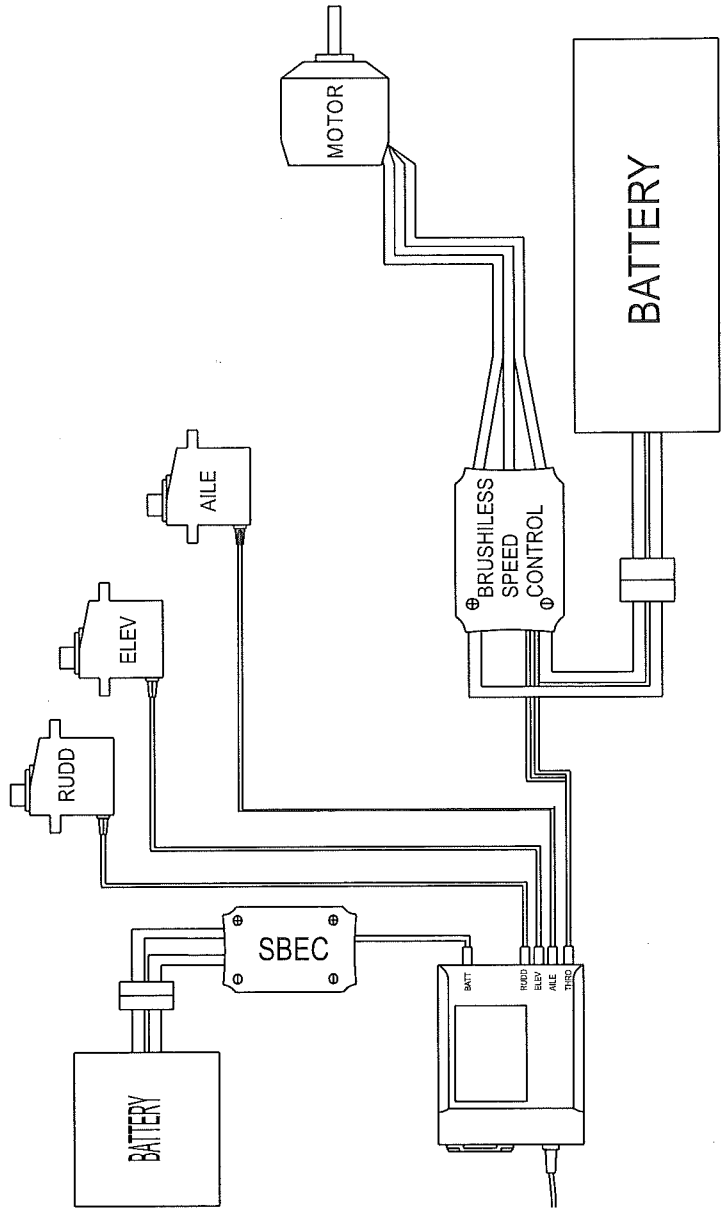



SUPER FLYING MODEL  
MANUFACTURE

MTH HOBBY PRODUCTS INDUSTRIAL CO., LTD.  
[www.mth.com.tw](http://www.mth.com.tw) [mthhobby@mth.com.tw](mailto:mthhobby@mth.com.tw)  
© MTH HOBBY 2014