



SUPER FLYING MODEL
MANUFACTURE

FOURNIER RF-4D SCALE SPORT PLANE



No. EP-45

SPECIFICATIONS

WING SPAN: 1800 mm(70.86 in)

WING AREA: 33.5 dm²(519 in²)

LENGTH: 928 mm(36.5 in)

WEIGHT: 1100g(38.8 oz)

RADIO: 4 Ch

Warning

An RC aircraft is not a toy! If misused, it can cause serious bodily harm and damage to property. Fly only in open areas, following all instructions included with your radio.

Before beginning the assembly, remove each part from its bag for inspection. Closely inspect the fuselage, wing panels, rudder and stabilizer for damage. If you find any damaged or missing parts, contact the place of purchase.

INSTRUCTION MANUAL

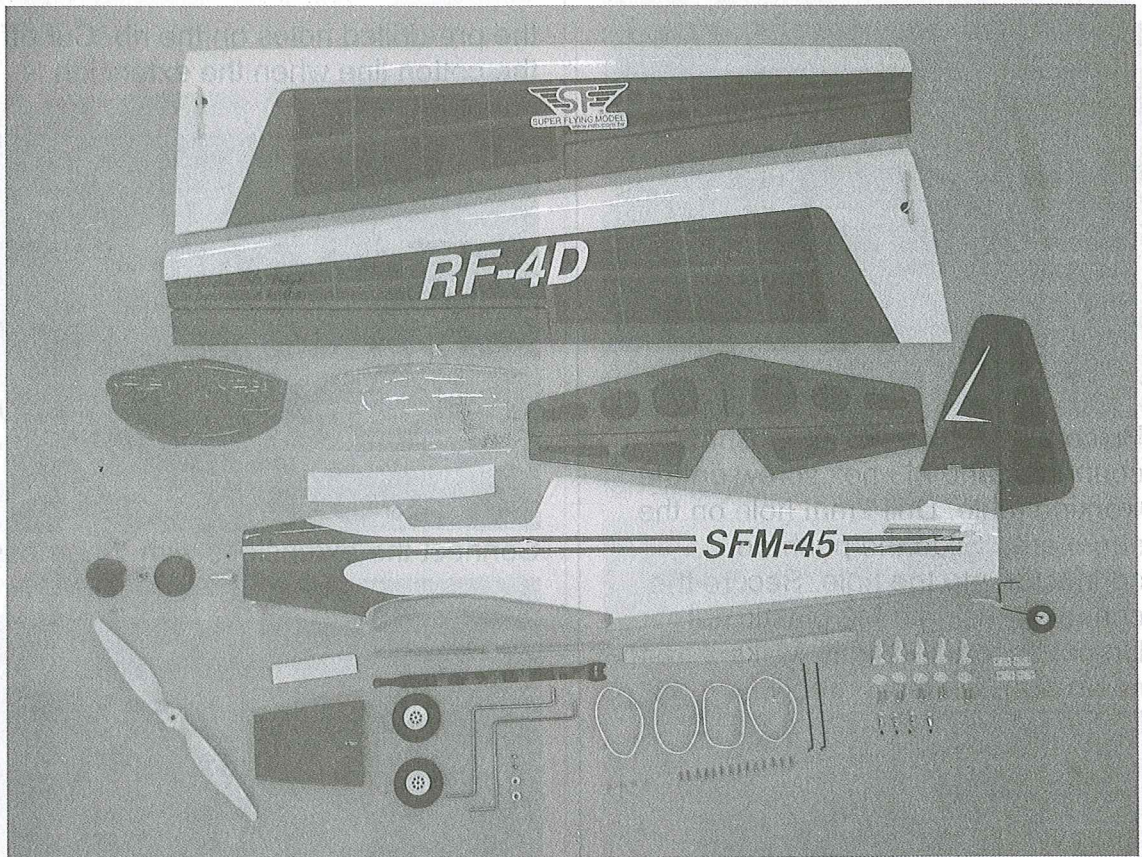

Contents of Kit / Parts Layout

Recommended radio and electronic equipment (Not included in kit):

- | | |
|---------------------------|--------------------------------|
| 4 Channels or up radio | Li-Po battery 2000mAh or up |
| 9g servo x 2 pieces | 3-Cell 11.1V battery |
| 17g servo x 2 pieces | 1000KV 12-Pole brushless motor |
| Receiver | 600mm extension x 2 pieces |
| Y-Harness | |
| 30A speed control (#2421) | |

Optional accessories



#2421 30A
brushless Speed Control

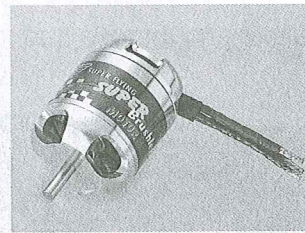

#2200-F18-1000-B 1000KV
12-pole brushless motor

Required Tools and Adhesives

- | | | |
|----------------------------|------------------|------------------------|
| Small Phillips Screwdriver | 1.5mm Hex wrench | Epoxy 5-minute |
| | Hobby Knife | Pen |
| 2mm drill | Ruler | CA glue |
| curved scissors | Pliers | solder iron and solder |

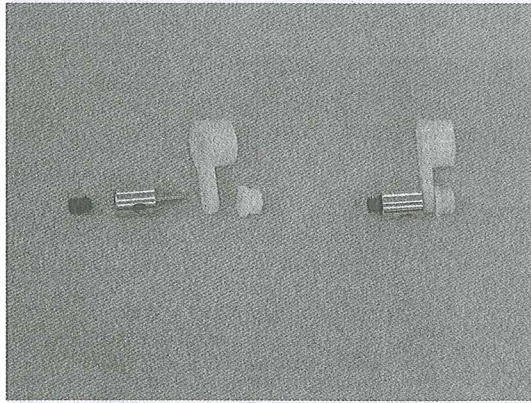

Place the M2 plastic nut, pushrod connector and M3 hex screw on the working table. Drill 2mm hole on the servo arm. Slide the pushrod connector into the hole. Secure the connector using a M2 plastic nut. Do not secure too tight. Make sure the servo arm can move freely.

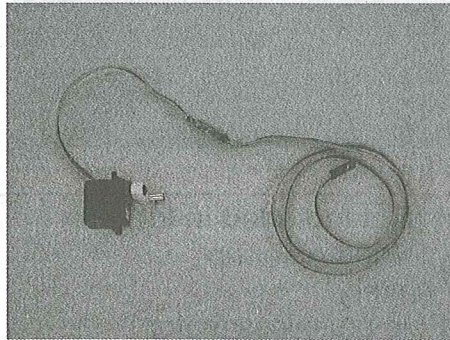

Connect the female plug of the 600mm extension with the male plug of servo. Use transparent tape to circle the connecting place for preventing loosening.

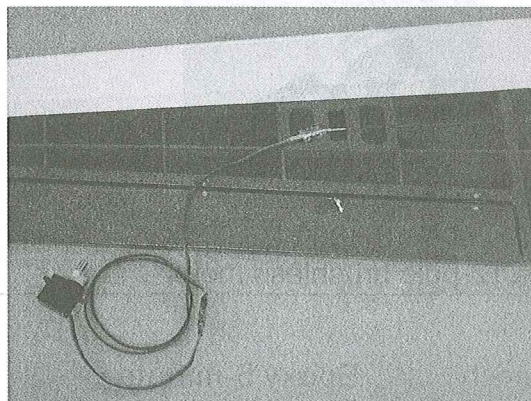

Tight cotton line on the male plug of the extension. Route the line through

the pre-drilled holes on the rib. Cut off the cotton line when the extension is out of the hole.

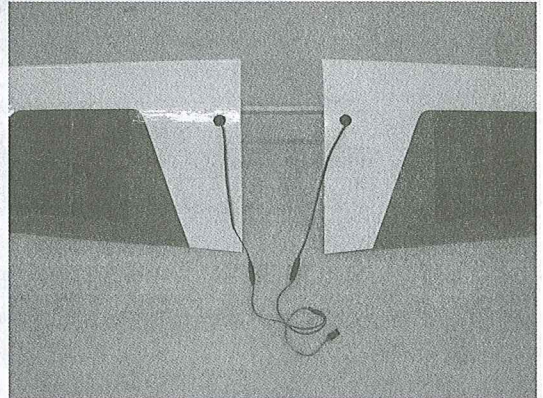

Connect the extensions with Y-harness.

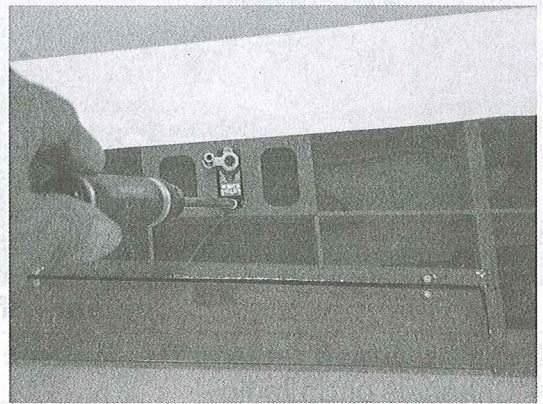

Secure the servo on the servo tray.

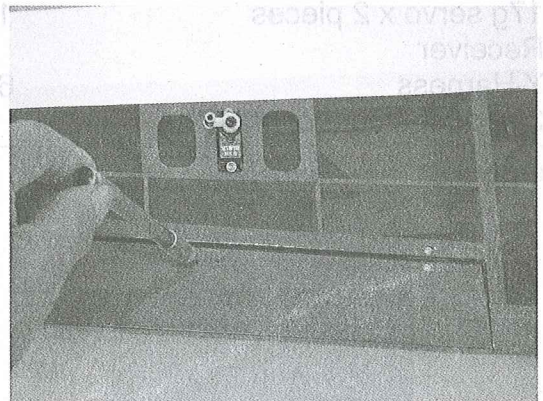

Take one piece of control horn out of the hardware bag. Place the control horn on the aileron and make sure its position is straight to the servo. Use pen to mark the holes on the aileron. Use 2mm drill to drill the holes.

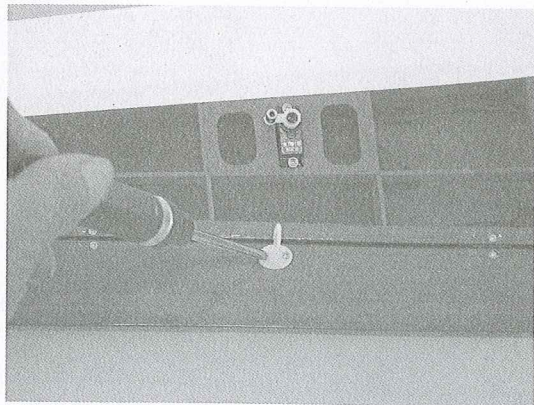

Use 2 pieces of 2x13mm screws to secure the control horn in place.

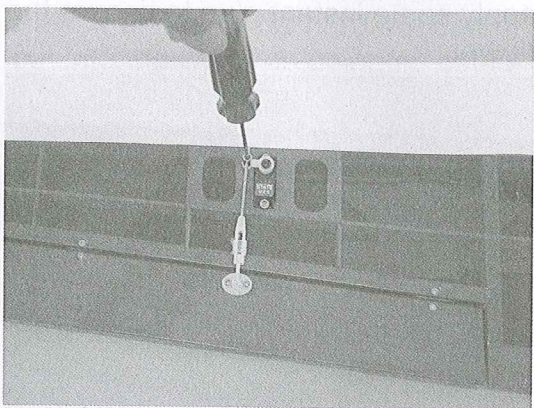

Thread the clevis on one end of the rod and connect the clevis with control horn. Slide in one piece of silicone tube. Slide the other end of rod into the servo arm. Center the aileron and secure the rod using 3 x 4mm hex screw.

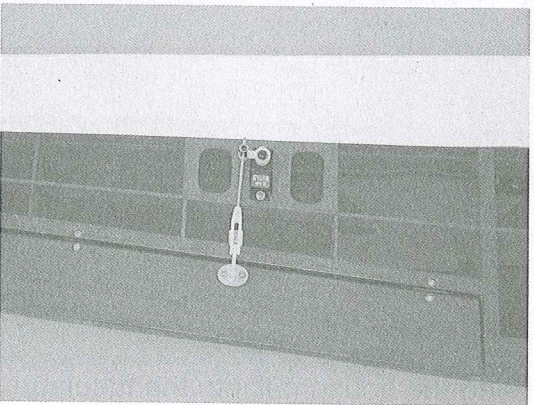

Move the silicone tube to the clevis for preventing the clevis loosening from control horn during flying.

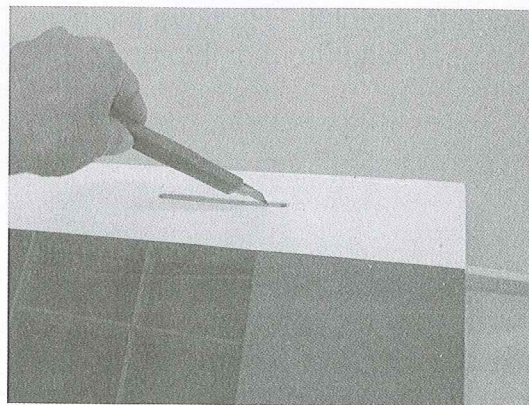

Use hobby knife to remove the covering on the pre-serving slot for the landing gear.

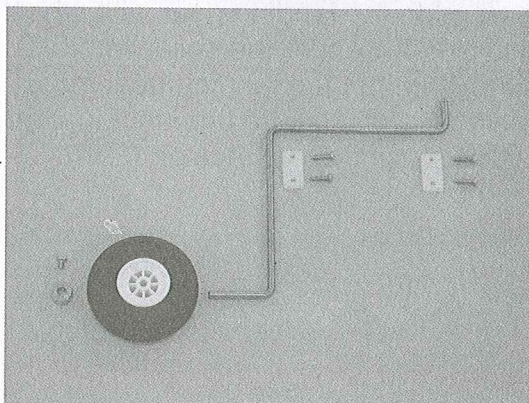

Take out the following accessories for assembling the landing gear:

- 3 x 10mm tapping screw 8 pieces
- gear plate 4 pieces
- collar 2 pieces
- 3x 6 screw 2 pieces
- wheels 2 pieces

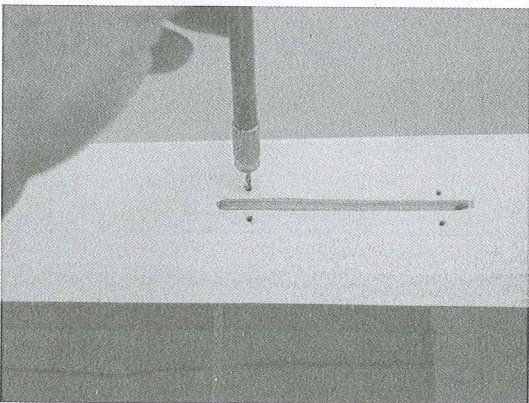

Insert the landing gear into the gear slot. Place the gear plate over the slot. Using pen to mark the position for

securing the plate. Remove the plate and gear. Use 2mm drill to open the holes.

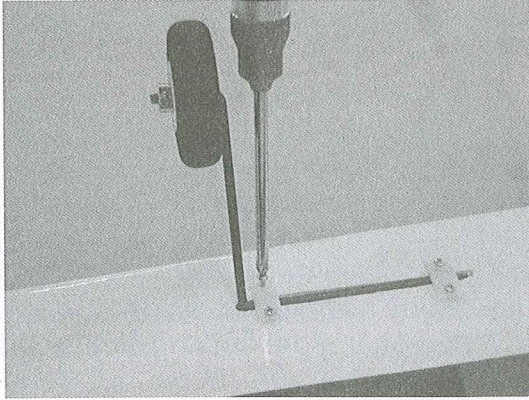

Assemble the landing gear with wheel and collar. Secure the collar with 3x6 screws. Insert the landing gear into the gear slot. Secure the landing gear in place using the plates and 3x10 tapping screws.

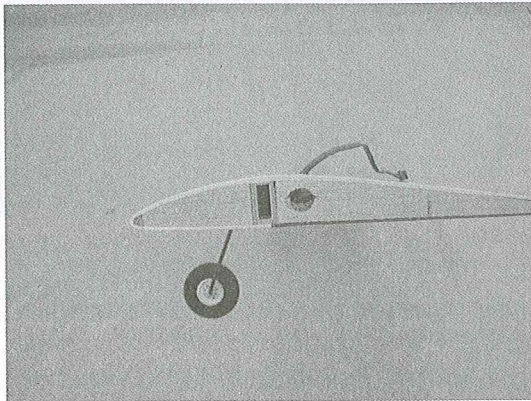

Please note the landing gear will be forward 10 degree after assembly.

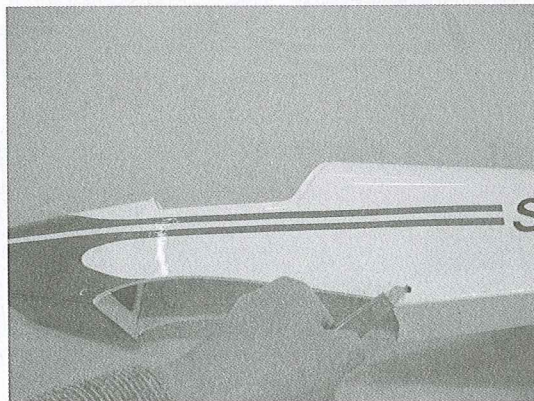

Use hobby knife to cut off the covering on the dowel hole.

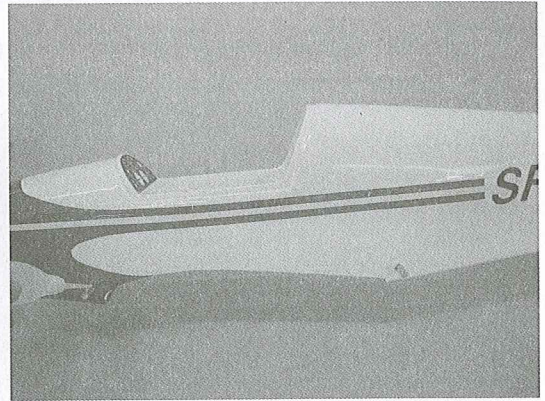

Insert the dowel. Make sure the dowel on both sides are the same length and apply some instant glue to secure the dowel.

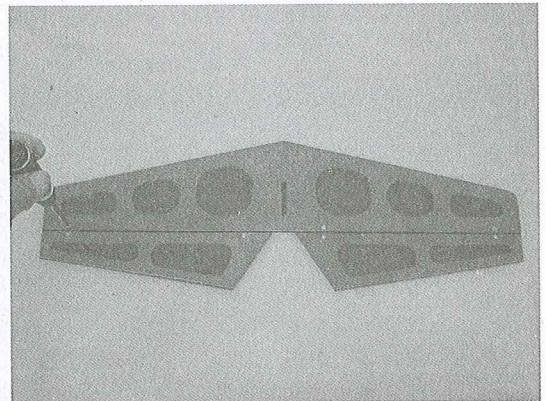

Place the horizontal on the working table. Use Philip screw to loose the screws on the hinges for removing one piece of elevator temporary.

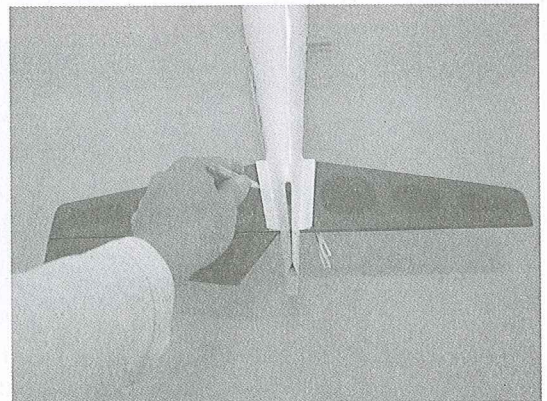

Slide the horizontal into the fuselage. Center the horizontal to the fuselage and carefully mark the position with a pen at the junction where the horizontal meets the fuselage.

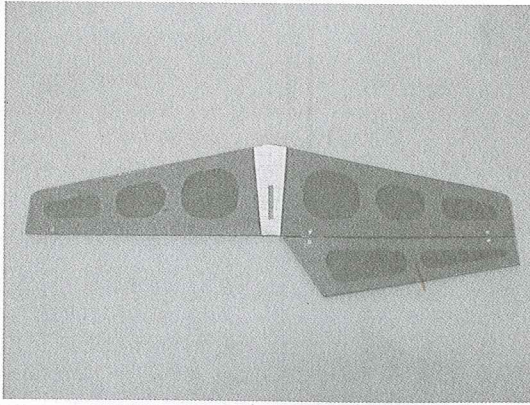

Using hobby knife, carefully cut the covering inside the marking lines. Please do not press hard enough to cut into the wood as doing so could weaken the horizontal.

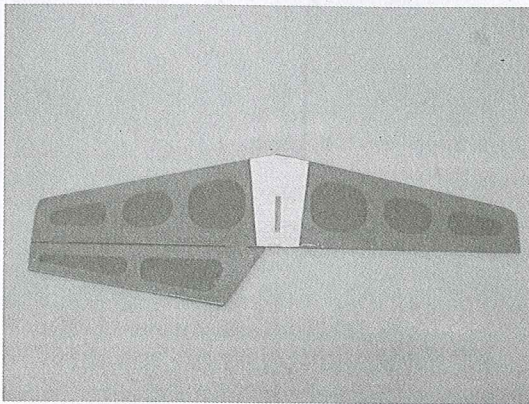

Repeat the same procedure to remove the covering on the top of horizontal.

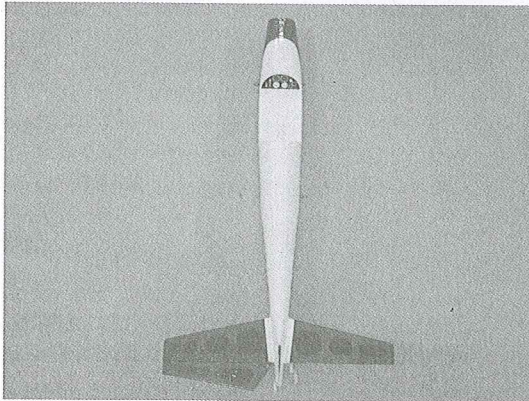

Slide the horizontal into the fuselage.

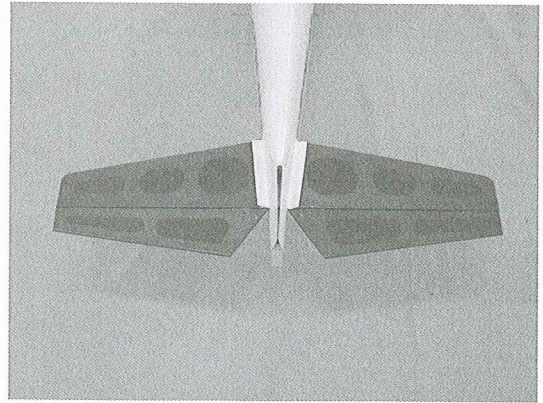

Secure the stabilizer back temporary.

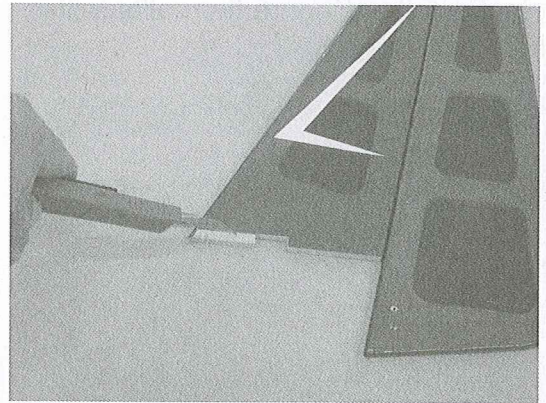

Use hobby knife to cut off the covering on the vertical where it will meet the horizontal. Please do not press hard enough to cut into the wood.

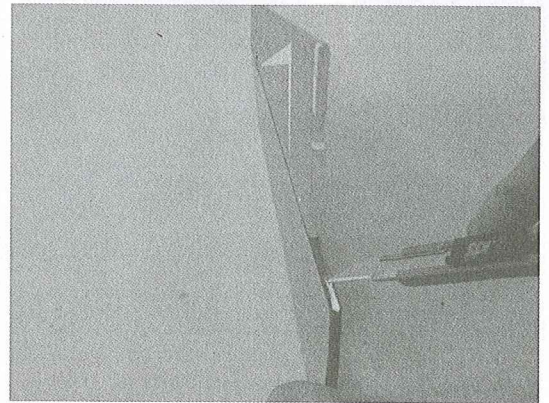

Use hobby knife to open the slot on the bottom of rudder for inserting the tail gear.

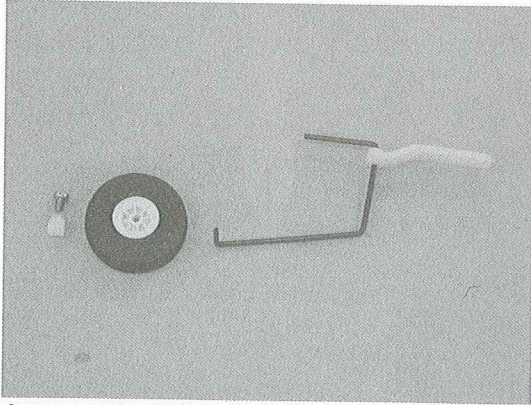

Assemble the tail gear with wheel and plastic collar. Secure the collar with M3x6 screw.

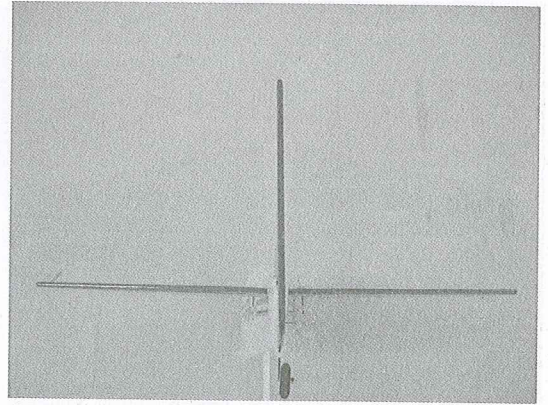

Secure the vertical on the horizontal use epoxy. The vertical must be perpendicular to the horizontal.

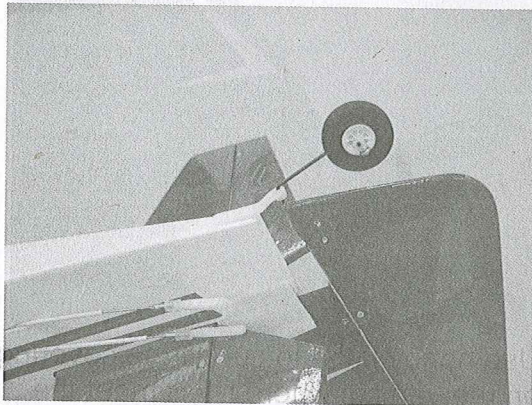

Try to fit the rudder into the fuselage.

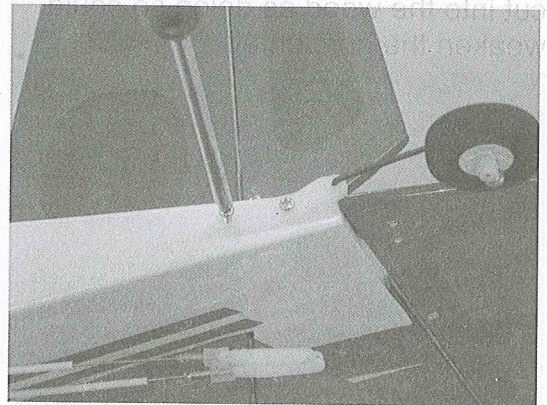

Use 2 pieces of 3x10mm tapping screws to secure the tail gear on the fuselage.

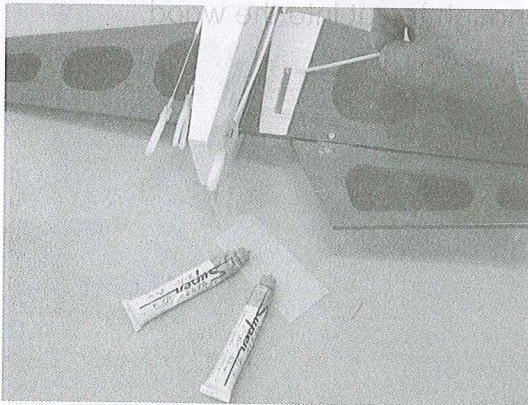

Spread epoxy on the bottom of the horizontal where it meets the fuselage.

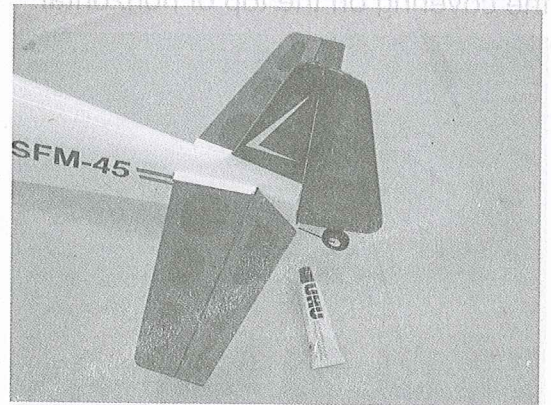

Suggest using UHU glue to secure the top of the horizontal on the fuselage.

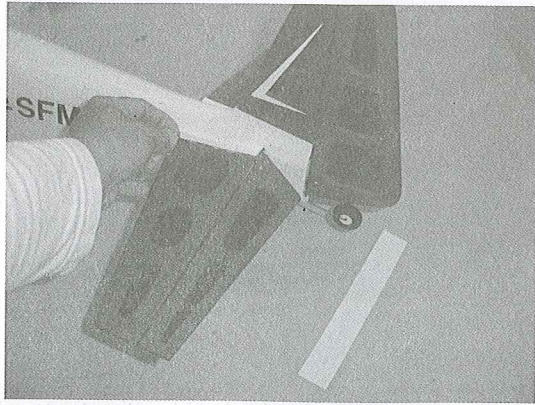

Apply the supplied transparent tape on the junction where the horizontal meets the fuselage.

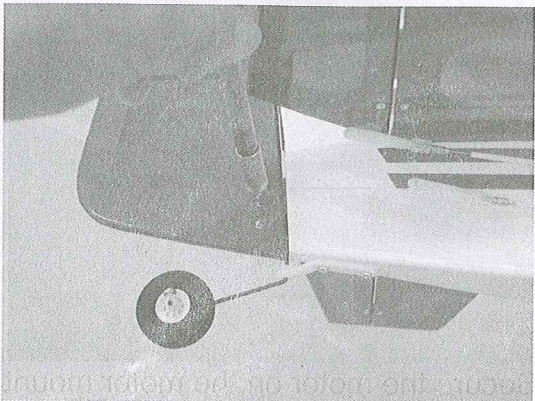

Drill 2mm holes on the rudder for securing the control horn.

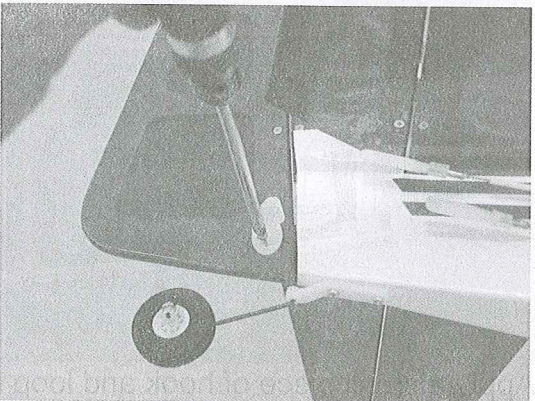

Place the control horn over the 2mm holes and secure it with 2x13mm screws.

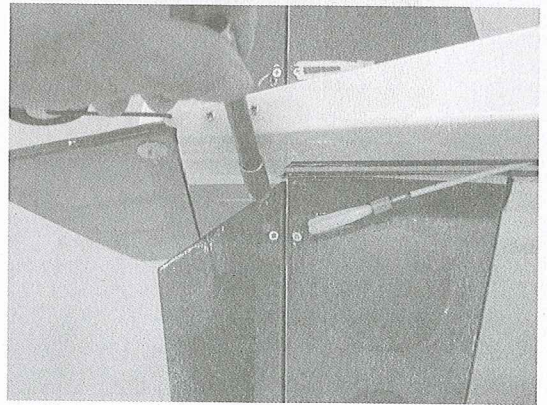

Drill 2mm holes on the bottom of elevator for securing the control horn.

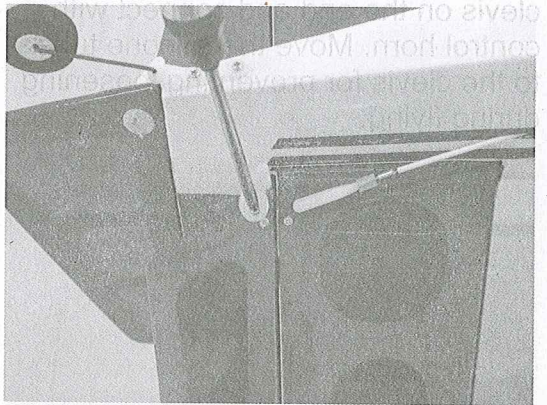

Place the control horn over the holes and secure it with 2x13mm screws.

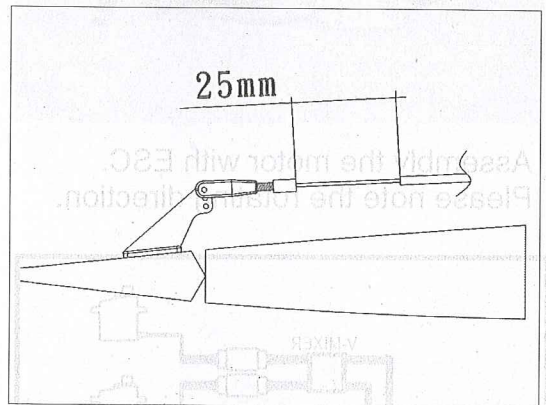

Please leave 25mm space between the pushrod tube and the clevis. Apply some instant glue to secure the pushrod tube on the fuselage.

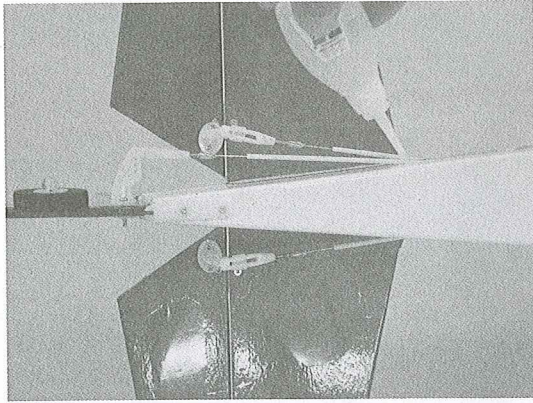

Slide the rod into one piece of supplied silicone tube, thread the clevis on the end and connect with control horn. Move the silicone tube to the clevis for preventing loosening during flying.

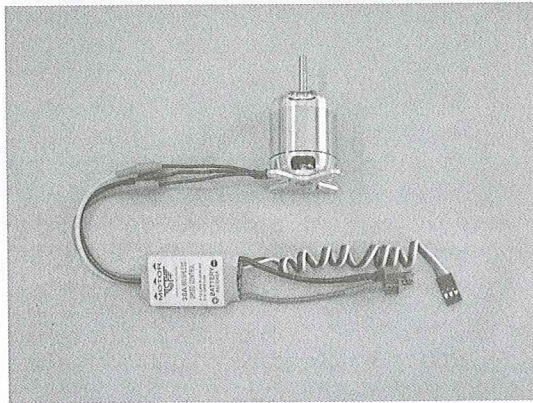

Assembly the motor with ESC. Please note the rotating direction.

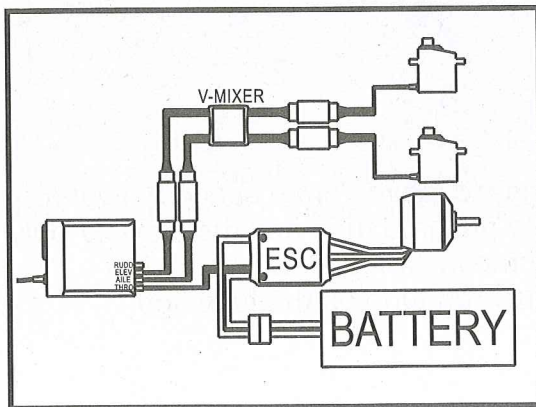
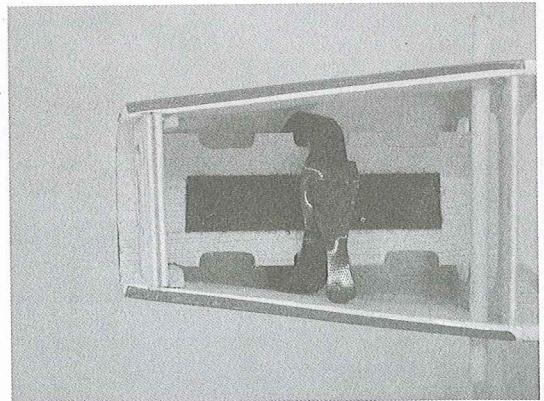
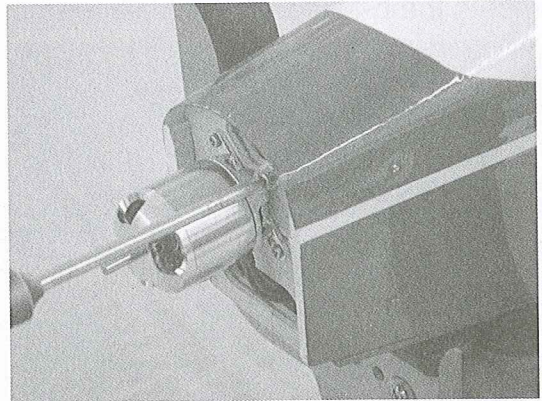

Diagram for the cables connection.



Apply the hook and loop on the battery tray.



Secure the motor on the motor mount with 4 pieces of 3x10 tapping screws.

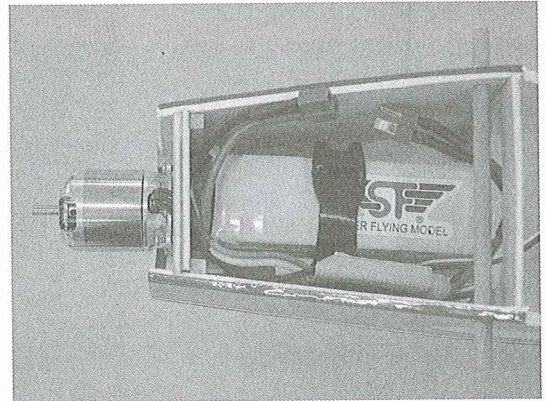

Apply a small piece of hook and loop on the ESC. Install the battery pack. Secure the ESC beside the battery.

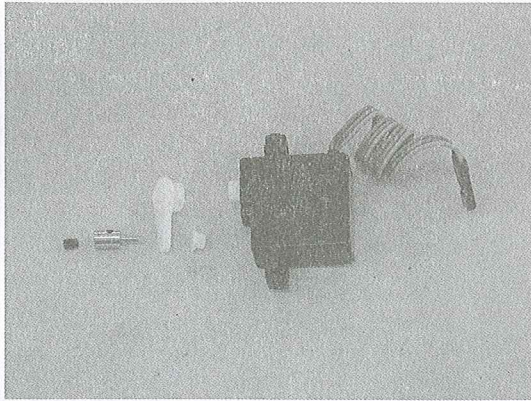

Place two 17g servos on the working table. Assemble the rod connectors on the servo arms.

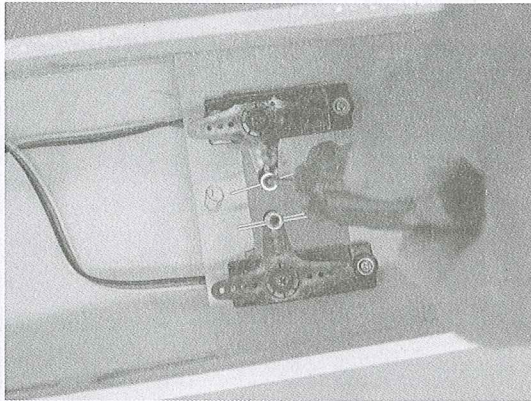

Secure the 17g servo tray (inside the fuselage) Slide the pushrod wire through the pushrod connector. Center the rudder and rudder servo. Secure the wire using a 3x4 hex screw. Repeat the same procedure for the elevator servo.

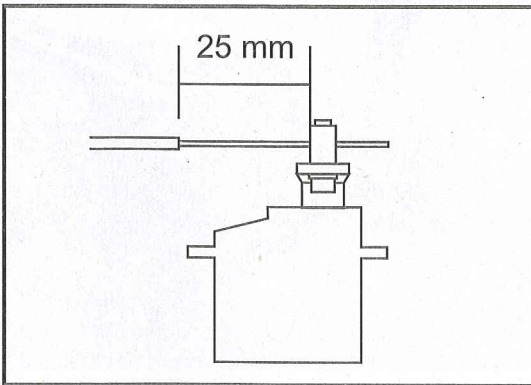

Please leave 25mm space between the pushrod tube and the pushrod connector.



Pull the pushrod tube straight and apply some instant glue to secure the pushrod tube on the planking.

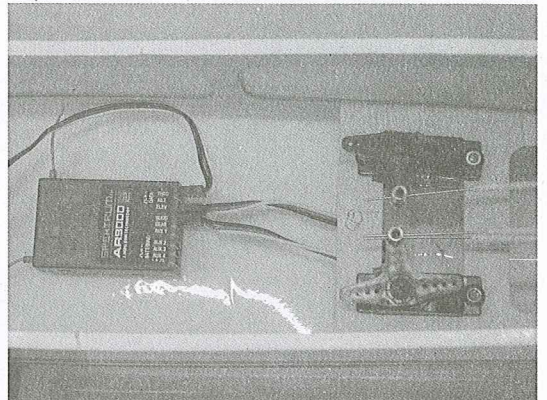

Secure the receiver using the hook and loop strap.

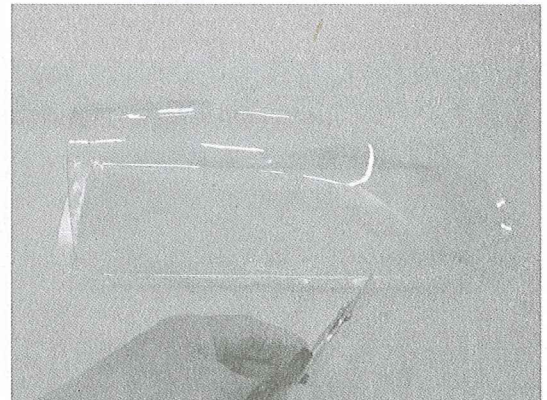

Trim the canopy according to the tooling line.

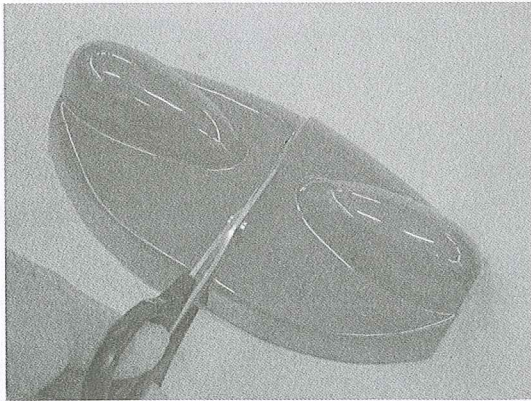

Use hobby knife to cut the plastic engine moulding separately.

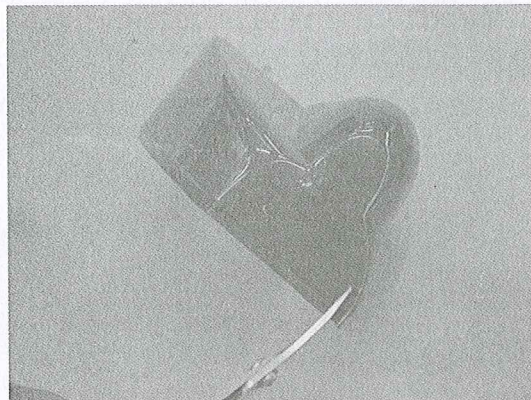

Trim the cowling according to the tooling line for opening the hole for motor and vent.

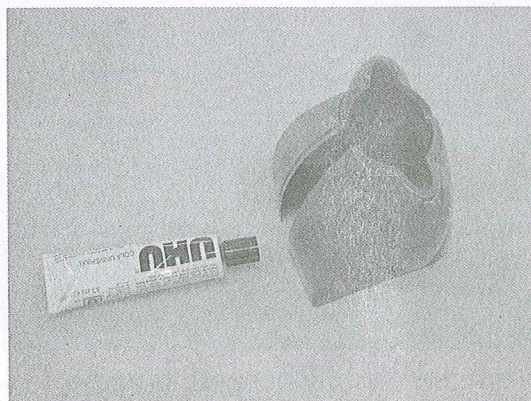

Suggest using UHU glue to secure both cowlings together.

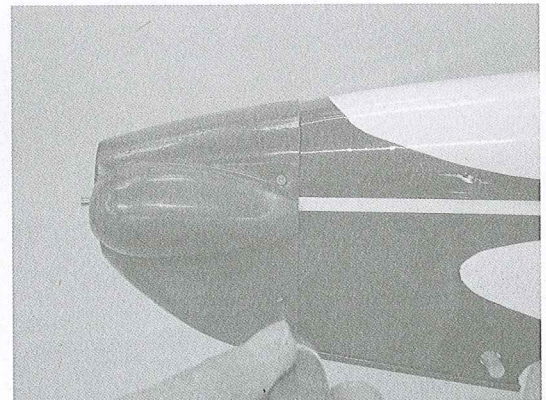

Try to fit the cowling on the nose. When satisfy the position, use 4 pieces of 2x6 screws to secure the cowling on the nose.

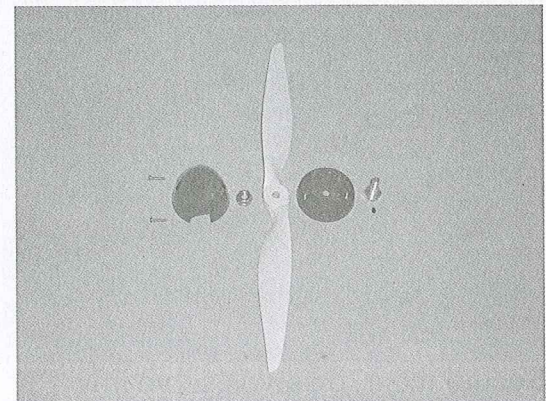

Assemble the spinner with propeller using following accessories: Spinner, Aluminum adaptor, Nut, 2 pieces of 3x10 screws, 11 x 5.5 propeller, 3x4 hex screw

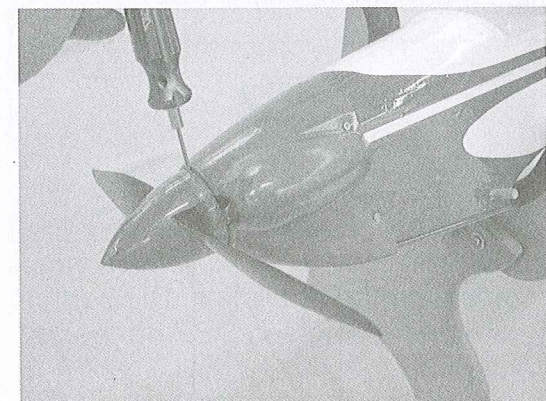

Try to fit the spinner into the motor and secure the spinner with 3x4mm hex screw.

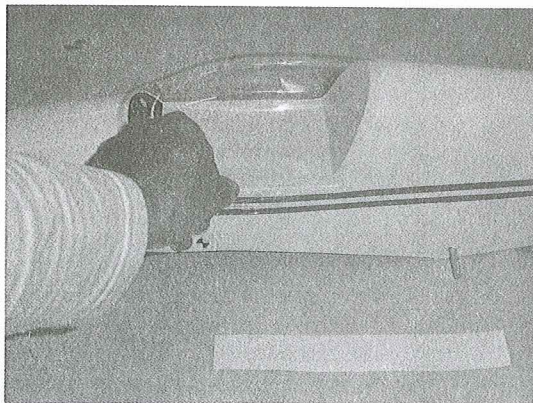

Try to fit the canopy on the fuselage. When satisfy the location, apply the supplied transparent tape to secure the canopy in place.

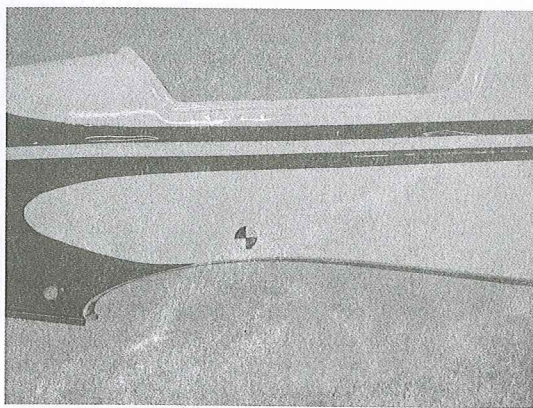

Center of Gravity
The recommended Center of Gravity location is 70mm back from the leading edge against the fuselage.

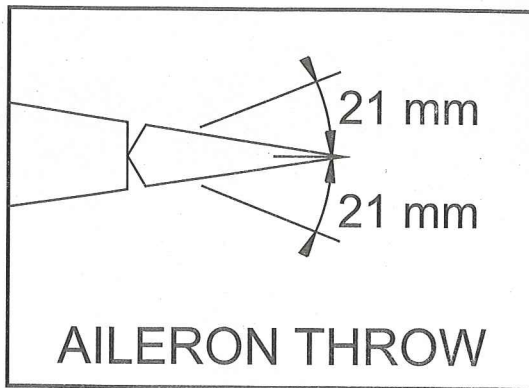

AILERON THROW

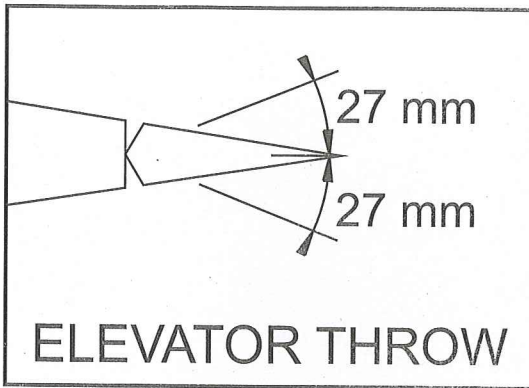

ELEVATOR THROW

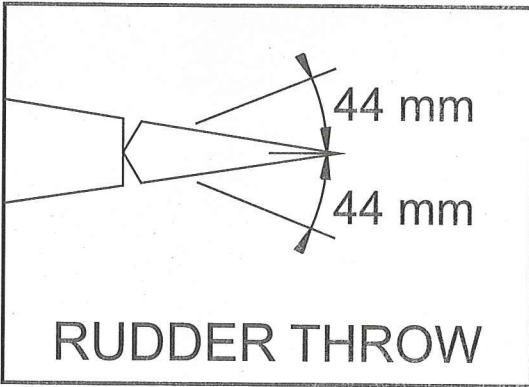

RUDDER THROW



SUPER FLYING MODEL
MANUFACTURE

MTH HOBBY PRODUCTS INDUSTRIAL CO., LTD.
www.mth.com.tw mthhobby@mth.com.tw
© MTH HOBBY 2010