

**THIS MODEL IS NOT A TOY!**

# INSTRUCTION MANUAL

THESE INSTRUCTIONS SHOULD BE READ BY A SUPERVISING ADULT

## 2.4GHz RTR BINARY MICRO R/C CATAMARAN SAILBOAT

Model No:8807

### IMPORTANT :

1. This is not a toy. Assembly and operating of this boat requires adult supervision.
2. Please take time to read the instructions carefully and completely before attempting to operate your model.  
This manual contains the instructions you need to safely build, operate and maintain your R/C sailboat.

### CONTENTS OF SET



BINARY catamaran hull  
(Servos, receiver &  
battery box pre-installed)

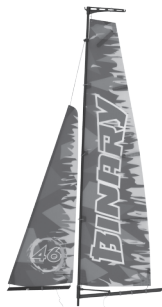

Sails & mast & booms set

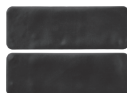

Two PVC hatch sets



2.4GHz 2CH transmitter  
(two joystick are included  
in battery compartment)



CROSS-HEAD SCREWDRIVER - 1PC  
(NOT INCLUDED)

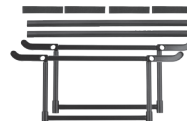

Boat stand set

### IMPORTANT TIPS

Jib boom and main boom are installed with silicone O rings. Adjust rings position on booms so as to adjust jib sail and main sail closing and opening angle easily.

### ITEMS REQUIRED FOR COMPLETION

- 4 x "AA" alkaline batteries for transmitter (not included)
- 3 x "AAA" alkaline batteries for receiver (not included)



### FCC REQUIREMENT



This device complies with Part 15 of the FCC Rules. Operation is subject to the following two conditions: (1) This device may not cause harmful interference, and (2) This device must accept any interference received, including interference that may cause undesired operation.

**CAUTION:** Changes or modifications to this product not expressly approved by the party responsible for compliance may void the user's authority to operate the equipment.

## BASIC BOAT TERMINOLOGY

**BOW:** The front of the boat.

**STERN:** The back of the boat.

**PORT:** This is the left side of the boat when view the boat from the stern. An easy way to remember this is that port and left both contain four letters.

**STARBOARD:** This is the right side of the boat when view the boat from the stern.

**HULL:** The body of the boat.

**DECK:** The top of the boat.

**KEEL:** A weighted blade that protrudes from the bottom of the hull as a means of providing lateral stability.

**RUDDER:** The hinged vertical plate mounted at the stern that controls steering.

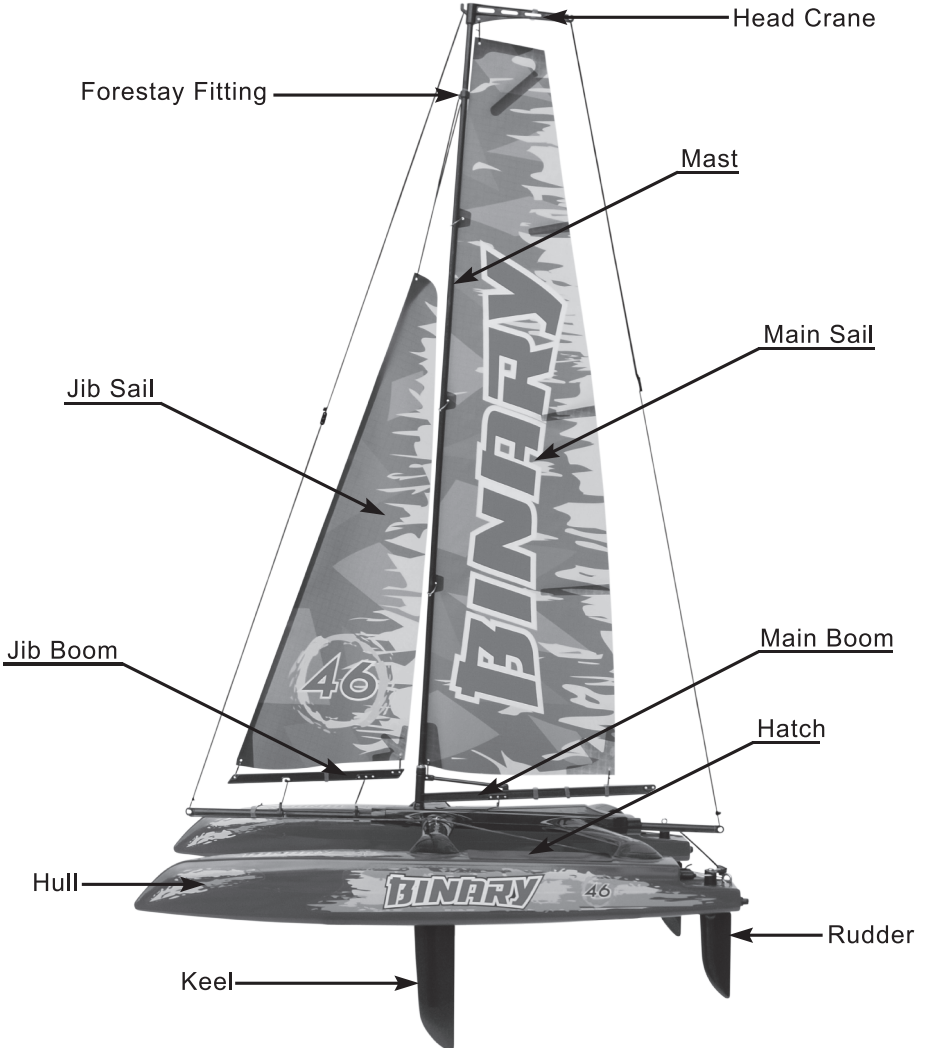

## INSTALL 4 PCS “AA” ALKALINE BATTERIES IN YOUR TRANSMITTER

Install two control sticks before installing 4 pcs “AA” batteries.



### Always use fresh AA alkaline battery in the transmitter.

1. Ensure transmitter “POWER” switch is in the off position.
2. Slide off the battery door on the back of the transmitter.
3. Install 4 fresh “AA” alkaline batteries into the molded battery compartment of transmitter. Noting correct location (polarity + or -)
4. Re-install the battery door onto the back of transmitter.

**IMPORTANT NOTE:** It is very important to keep the throttle stick at its lowest position before switch on transmitter. So that when you install batteries for receiver, radio and boat are activated only on the condition that throttle stick is at its lowest position. (Green indicator light is solid on means transmitter is activated, if flash, push down the throttle stick till the lowest position)

5. Switch “POWER” on, green indicator light is on. Otherwise, check the above processes again to reinstall batteries.



## DISPLAY STAND ASSEMBLY

1. Assemble two pcs of side stand as photo shown.
2. Install two pcs of long tube between two side stand as photo shown.



3. Install four pcs of EVA on the hull support as shown. This will protect the hull bottom from scratches during construction and storage.

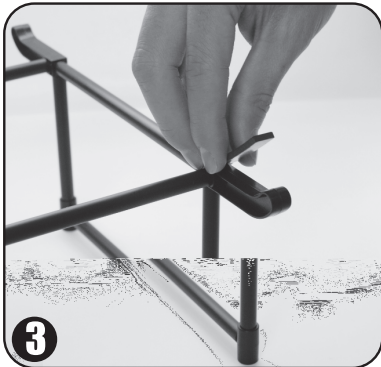

## TAKE BOAT & SAILS OUT FROM BOX

1. Take inner cardboard box out, disassemble two pcs pinch plate as photo shown.
2. Use cross-head screwdriver to remove two pcs of screws underneath the boat central spar as photo shown.

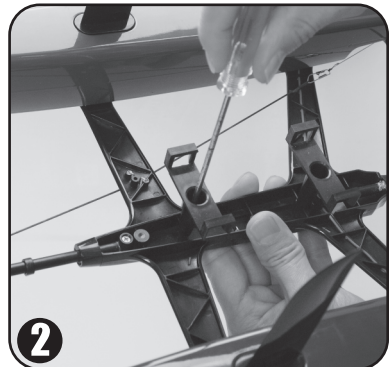
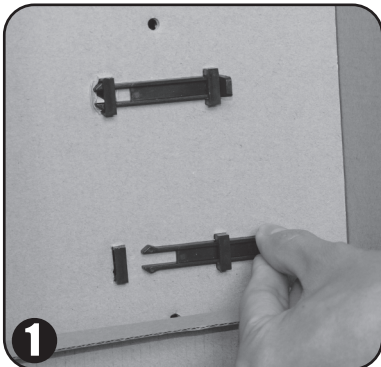

3. Place the boat on the display stand for next step assembly.
4. Take Sails & Mast & Booms set (pre-installed) out from box.

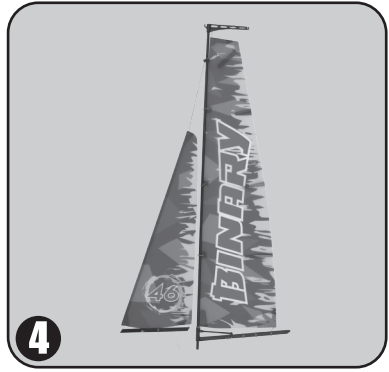

## SAILS RIGGING

1. Insert Mast on the mast mount located on the central spar as photo shown.
2. Use cord on rear end of central spar to attach to hook of backstay crane as photo shown. Adjust cord bowsie to pull the backstay cord tight and straight.

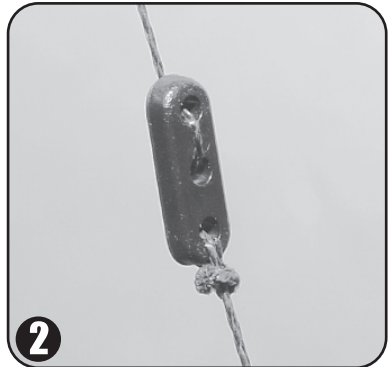
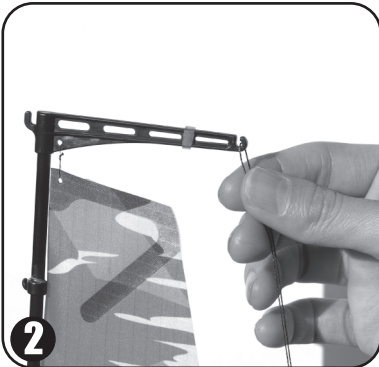
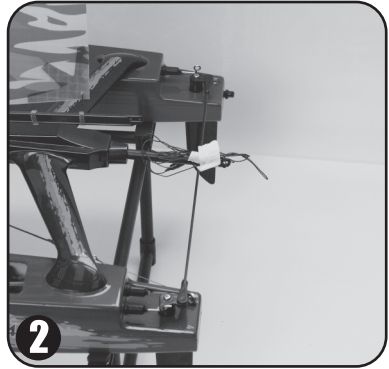
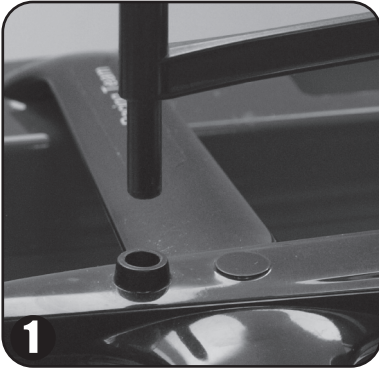

3. Use cord on front end of central spar to attach to hook of backstay crane as photo shown. Adjust cord bowsie to pull the forestay cord tight and straight.

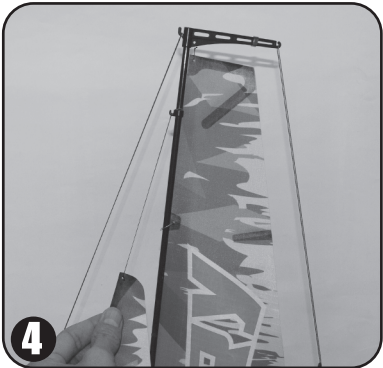
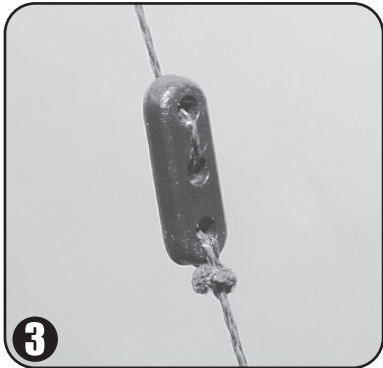
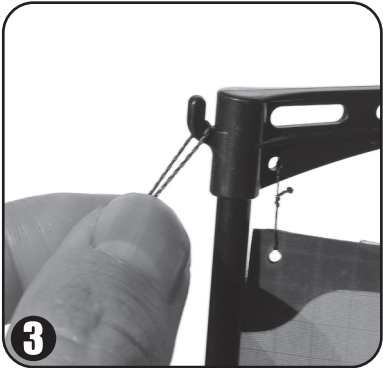
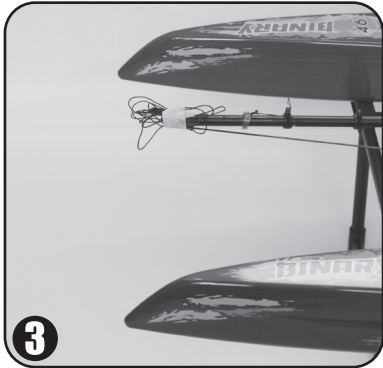

5. There is cord loop which attached to the silicone ring on central spar, use this cord loop to attach to hook underneath the jib boom. Adjust the silicone ring to pull cord tight.

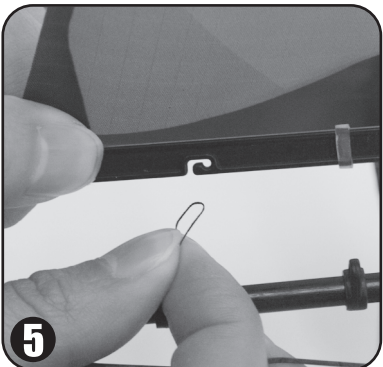

- Use jib boom cord to thread through the second boom bend eye (from front side back to rear side) located in central spar, thread through the sheeting deck eyelet on forward cross beam, attach cord loop to the pin as photo shown.
- Use main boom cord to thread through sheeting deck eyelet on center of cross beam, then thread through sheeting deck eyelet on forward cross beam, attach cord loop to the pin as photo shown.

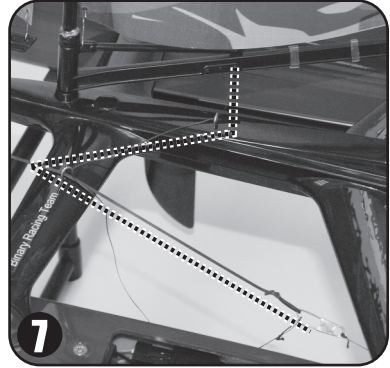

- Adjust the B & C silicone ring on main boom to adjust the main sail radian as photo shown.

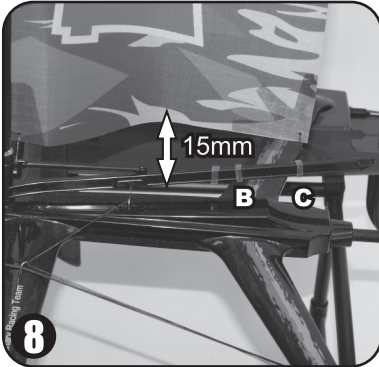

## INSTALL 3 PCS "AAA" ALKALINE BATTERIES IN RECEIVER

**IMPORTANT NOTE:** Always switch on the transmitter before switch on the receiver and always switch off the receiver before switch off the transmitter.

Install 3 pcs AAA alkaline batteries into battery box of BINARY.

- Push down the throttle stick (left stick ) to the lowest position as shown,then switch on transmitter;
- Install 3 pieces of "AAA" Alkaline batteries into the receiver box,make sure the correct polarity. then fix battery box well with velcro strap.

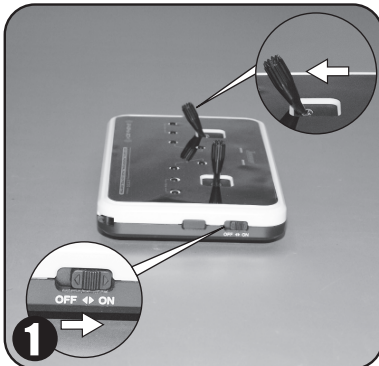

3. Switch on the receiver by pushing the pushrod forward to position “on”. This moment the receiver green light will be on, and steering servo and sailing servo in boat are under control correspondingly of radio control.

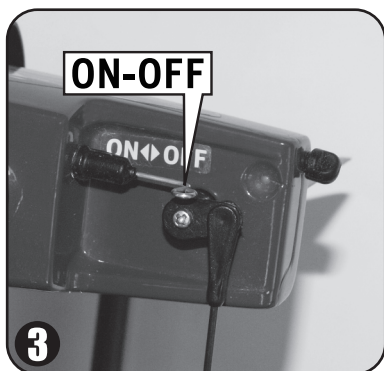

## TRANSMITTER & RECEIVER BINDING

The binding process effectively ties the transmitter and receiver together. Under normal circumstances, both items are supplied like this from the factory. If, however, you find that your transmitter and receiver are not bound (receiver's red LED will turn on), you should do the following:

1. Make sure throttle stick (Left Stick) is pushed down till the end, switch on transmitter. Indicator light is solid on.
2. Install 3 pcs of “AAA” alkaline batteries into battery box in correct polarity, then fix battery box well with velcro strap.
3. Switch on the receiver by pushing the pushrod forward to position “on”.
4. Press down the “BIND” button on the receiver and release, the receiver's green light will flash and then turn to solid on, this indicates that binding process has been operated successfully and the receiver will now accept commands from the transmitter.

**Note:** During binding process, transmitter and receiver should be no more than one meter apart and no other similar devices should be within 10 meters. If the receiver's GREEN light is flashing, indicating a binding failure, Please repeat the binding process above.

## PREPARATIONS FOR SAILING

Before sailing your BINARY for the first time, Always switch on the transmitter before switch on the receiver and always switch off the receiver before switch off the transmitter.

Following the procedures to check the radio and sailboat's function:

1. For sail control stick, when stick is in position A, accordingly, the main boom and jib boom are in the position of A as shown. When stick is in the position of B, accordingly, the main boom and jib boom are in the position of B as shown.
2. You may also adjust the sail servo neutral by pressing the sail neutral position trim button up or down.
3. For rudder control stick, rudder turn left when rudder control stick is pushed to the left. Rudder turn right when rudder control stick is pushed to the right.
4. You may also adjust the rudder servo neutral by pressing the rudder neutral position trim button left or right.
5. Check to make sure the left and right rudder will move together in same direction when push rudder control stick on transmitter.



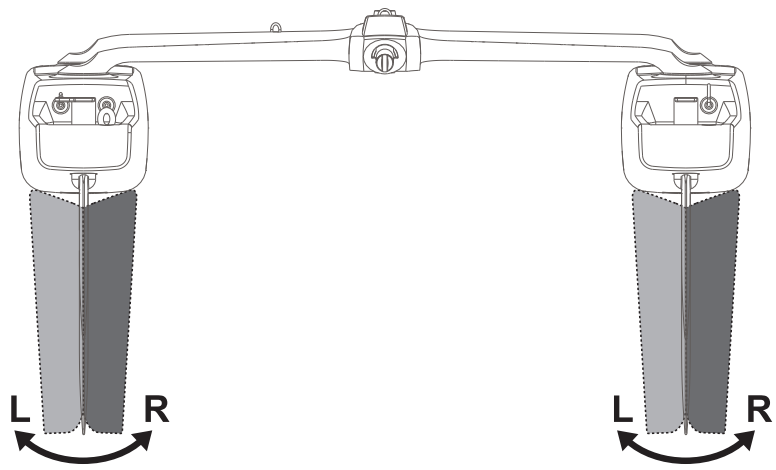
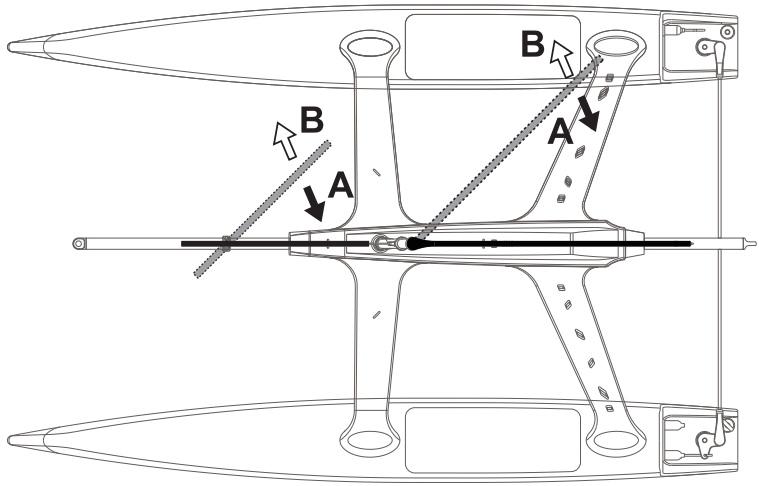
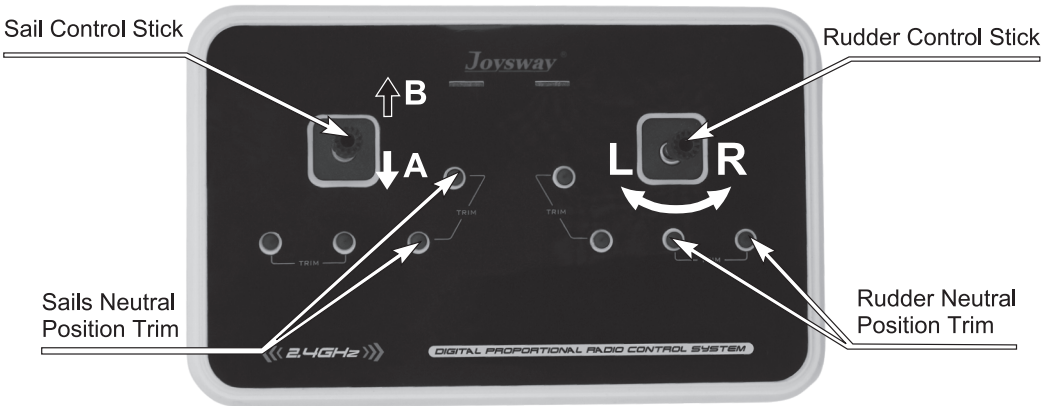

6. Adjust the silicone ring on central spar to pull jib boom tight.
7. Push down transmitter throttle stick (left stick) till its lowest position. This will make winch servo pull jib boom cord and main boom cord tight.
8. Adjust A silicone ring on main boom's position to make sure main boom is on the centerline of cross beam when winch servo pull main boom cord tight .

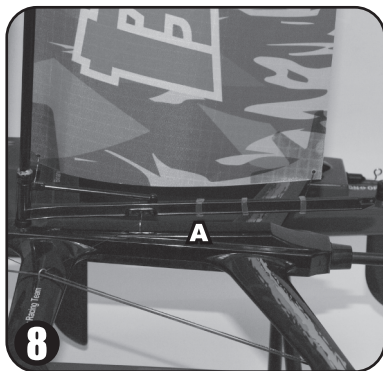
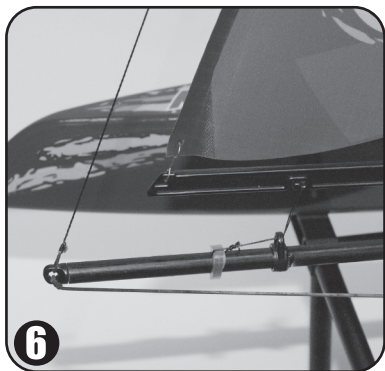

9. Adjust silicone ring on jib boom's position to make rear-end of Jib boom is moved away from mast at 15mm-20mm distance when winch servo pull jib boom cord tight.
10. Push up throttle stick till its top position, to check whether main sail and jib sail can be freely open or not.
11. Lastly stick the two pcs of PVC hatch on the hull deck. Press the PVC hatch tight on the deck.

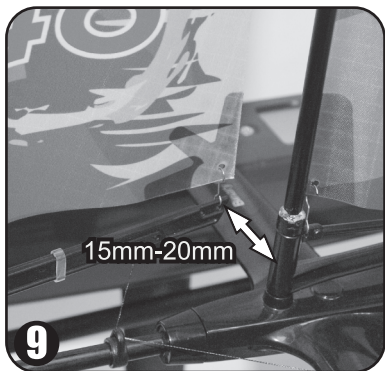

## SAILING THE BINARY

Unlike propeller driven boats that you basically point and accelerate, sailboats present an interesting challenge. Sailing requires constant reaction to water movements, any wind gusts, and any wind direction changes. These reactions then require adjustment of the rudder and sails in order to find the best possible course. There is no substitute for actual “on-the-water” experience and after your first couple of outings you may want to read through this manual again in order to help you to gain a better understanding of the “art” of sailing. While learning to sail, it is a good idea to pick up on as much sailing terminology as possible. This will make it easier to grasp some aspects.

# How To Sail BINARY

**Wind**



**Wind Abeam**

Sails: Each at a position of 45°  
Rudder: In center position

**Quarter Lee**

Sails: Letting both out a little more  
Rudder: to the left

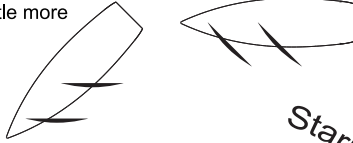

**Bearing Away**

Sails: Let both out so as not to shiver  
Rudder: To the left



**Starboard Tack -Running**

Sails: Letting both out to their maximum position  
Rudder: in center position



**Port Tack - Close - Hauled**

Sails: Keeping pulled in  
Rudder: To be held at the center as long as the sails do not shiver

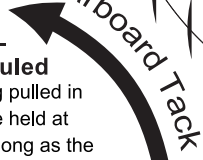

**Tacking**

Sails: Keeping pulled in  
Rudder: To the left



**Port Tack-Running**

Sails: Letting both out to their maximum position  
Rudder: in center position

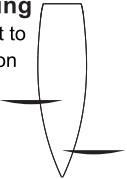

**Tacking**

Sails: Keeping pulled in  
Rudder: To the right



**Starboard Tack - Close - Hauled**

Sails: Keeping pulled in  
Rudder: To be held at the center as long as the sails do not shiver

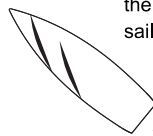

**Quarter Lee**

Sails: Pulling both in a little  
Rudder: In center position



**Tacking**

Sails: Keep pulled in  
Rudder: To the left



**Luffing Up**

Sails: Pulling in bit by bit  
Rudder: To the left



**Port Tack - Close - Hauled**

Sails: Keep pulling in  
Rudder: To be held at the center as long as the sails do not shiver



**Luffing Up**

Sails: Pulling both in all the way  
Rudder: To the left



**START Wind Abeam**

Sails: Each at a position of 45°  
Rudder: In center position



## IMPORTANT NOTICE:

1. Sail your BINARY only in still bodies of water. Never sail your boat in running water such as streams or rivers, as it is easy to lose control of your boat.
2. Do not sail BINARY in heavy winds.
3. Never attempt to swim after a stalled or stuck boat! Wait patiently for the wind currents to return the boat to shore.
4. After running, remove the deck and allow the interior of the boat to dry out completely. If you neglect to do this, it may result in corrosion of the electronic components.

## SPARE PART LIST

To order BINARY spare parts, use the part numbers in the spare parts list that follows.

<b>PART NO.</b>	<b>DESCRIPTION</b>
880701	left & right hull with black color painting, no decals
880702	left & right hull with blue color painting, no decals
880703	Decal stickers
880704	PVC deck covers (PK4)
880705	Blue color main and jib sails set
880706	Red color main and jib sails set
880707	Stainless steel guiding parts for booms attachment (PK5)
880708	mainsail luff rings and sails attachment hook (pk5)
880709	Mast,booms and fittings set
880710	ABS Beam set
880711	Central spar and plastic fittings set
880712	ABS keel (PK2)
880713	ABS Rudder (PK2) and rudder linkage set
880714	Servo and battery box tray
880715	battery box for 3pcs AAA
880716	Pushrod with rubber bellow
880717	Power Switch rod w/ rubber bellow & switch connector set
880718	Plastic boat stand set
880719	6cm length silicone tube(3*5)
880720	9g sail and rudder servo (PK2)
880320	5m dyneema cord 0.11mm
880318	2.4GHz Transmitter and receiver set
880511	1m Sheeting elastic
880516	2.4GHz receiver
880518	5m length dyneema cord(0.4mm)
880530	bowsies (PK10)
880531	6cm length silicone tube(4*8)
880532	deck eyes (pk10)
880536	Rubber bung (PK4)
880622	velco strap for battery box (PK2)
880623	winch line rubber cap (PK5)