





1

	9,5 mm	x1
	3/8"	x1
		x1



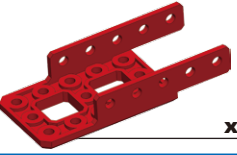

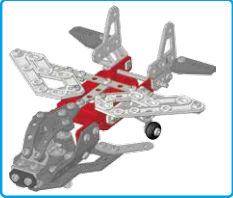
x1

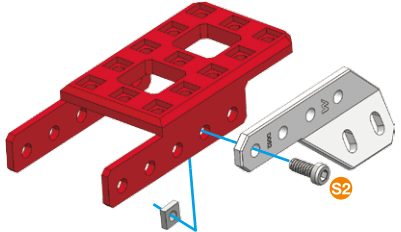

	S2	1:1
---	-----------	------------

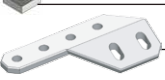

2

	9,5 mm	x1
	3/8"	x1
		x1



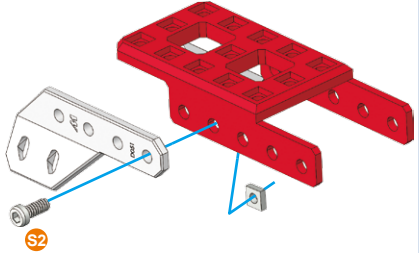

	S2	1:1
---	-----------	------------

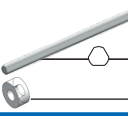

3

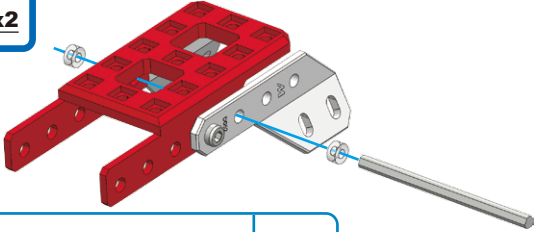
	63,5 mm	x1
	2 31/64"	x2



	1:1
--	------------

4

	x1
	x1
	x1

	1:1
--	------------

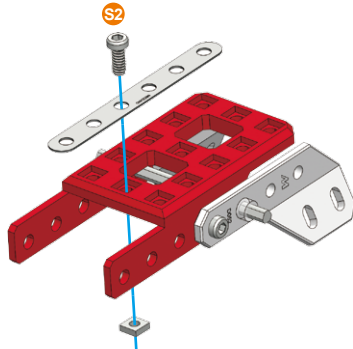

5

	x1
	x2
	x4
	x4

	1:1
--	------------

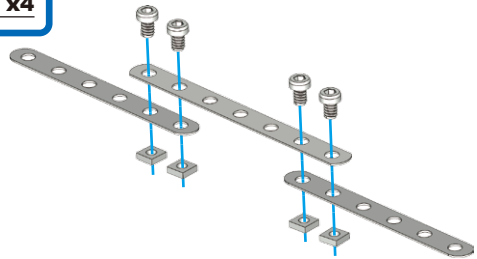

6 (4) + (5) +

	x1
	x1

	1:1
--	------------

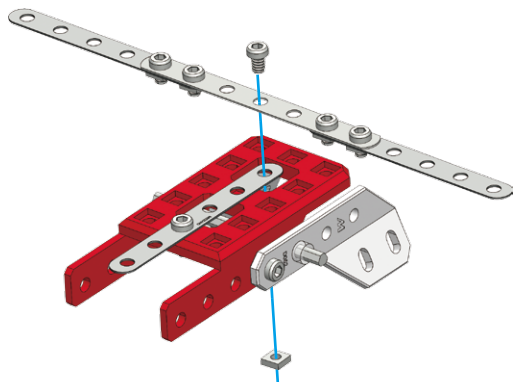

7

	x1
	x1
	x1
	x2

	1:1

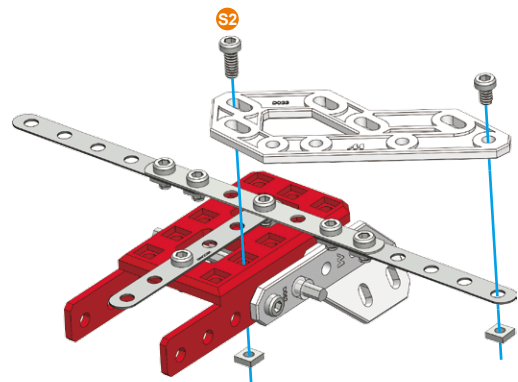

8

	x1
	x1
	x1
	x2

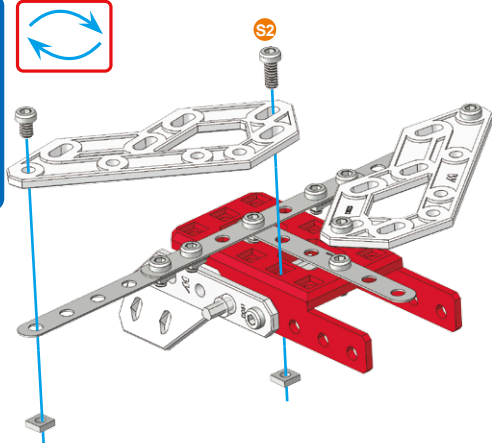

	S2	1:1
	S1	

9

	x1
	x2
	x2

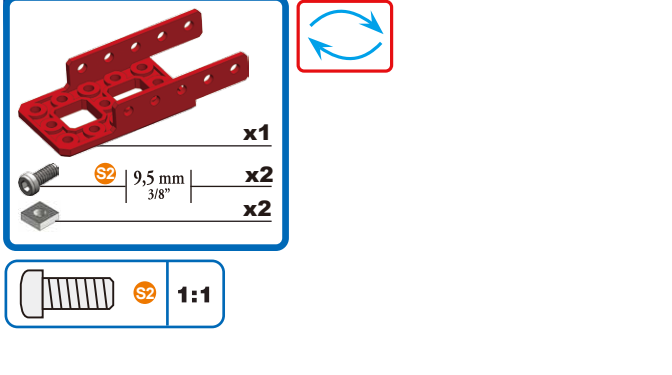

	S2	1:1
--	----	-----

10

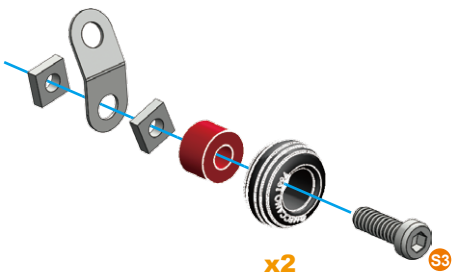

	x2
	x2
	x2
	x4
	x2

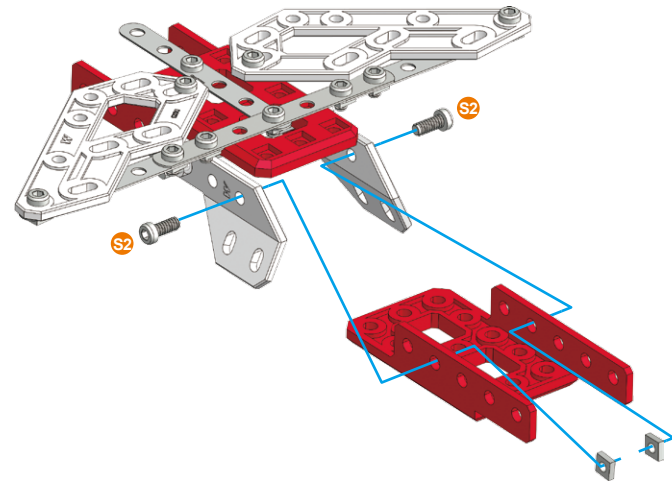

	S3	1:1
	A238	





11 ⑨ + ⑩ +

	S1 5,8 mm	x1
		x1

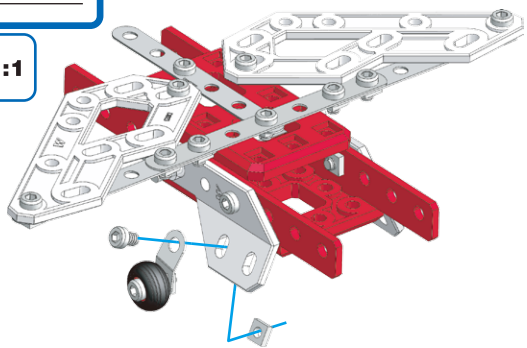
	S1	1:1
---	----	-----



12 ⑩ + ⑪ +





	S1 5,8 mm	x1
		x1

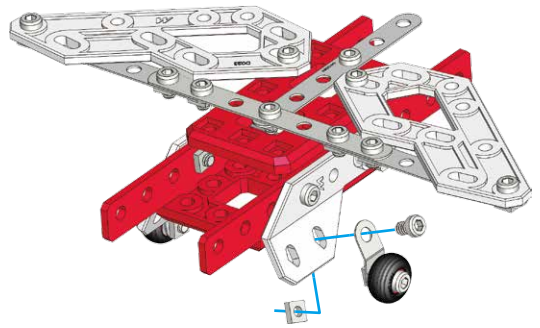

	S1	1:1
--	----	-----

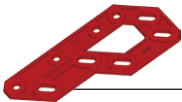

13

	x1	
	x1	
	x1	
	S1 5,8 mm	x2
		x2

	S1	1:1
---	----	-----

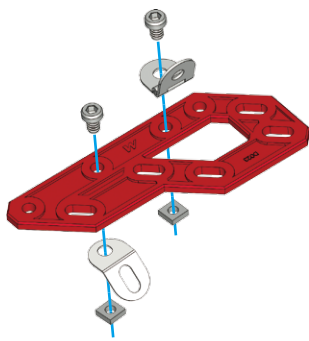

14

	x1	
	x1	
	S1 5,8 mm	x2
		x2

	S1	1:1
--	----	-----

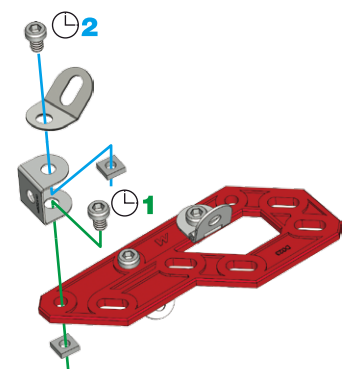

15

	x1
	x1
	x1
	x2
	x2

S1 | 5,8 mm | 15/64" | **x2**

S1 | **1:1**

16

	x1
	x2
	x2
	x2

S1 | 5,8 mm | 15/64" | **x2**

S1 | **1:1**

17

14+16+

	x1
	x2
	x2

S1 | 5,8 mm | 15/64" | **x2**

S1 | **1:1**



18

	x1
	x1
	x2
	x2

S1 | 5,8 mm | 15/64" | **x2**

S1 | **1:1**



19

	x1
 5,8 mm 15/64"	x2
	x2

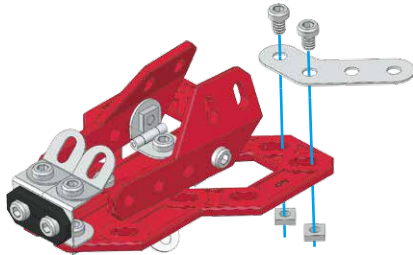
	S1	1:1
---	----	-----



20

	x1
 5,8 mm 15/64"	x2
	x2



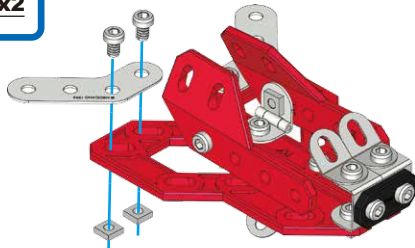

	S1	1:1
--	----	-----



21

12+ 20+



 9,5 mm 3/8"	x2
	x2

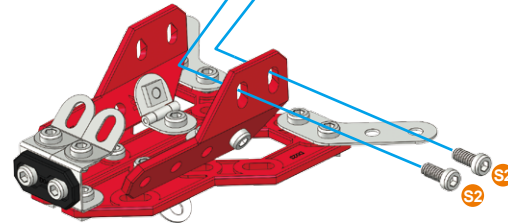
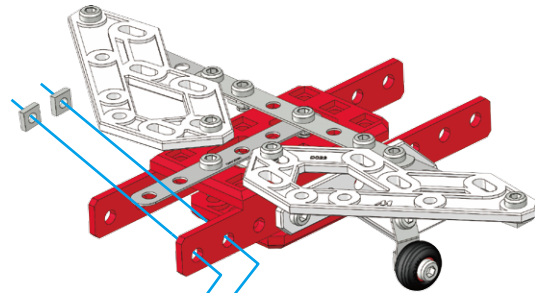

	S2	1:1
--	----	-----



22



	S2	9,5 mm	x2
	S2	3/8"	x2

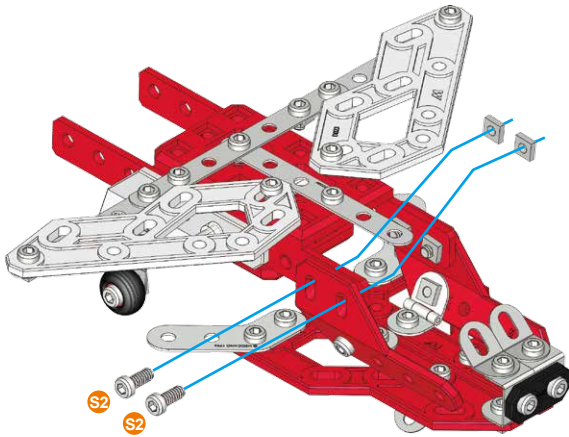

	S2	1:1
---	----	-----



23





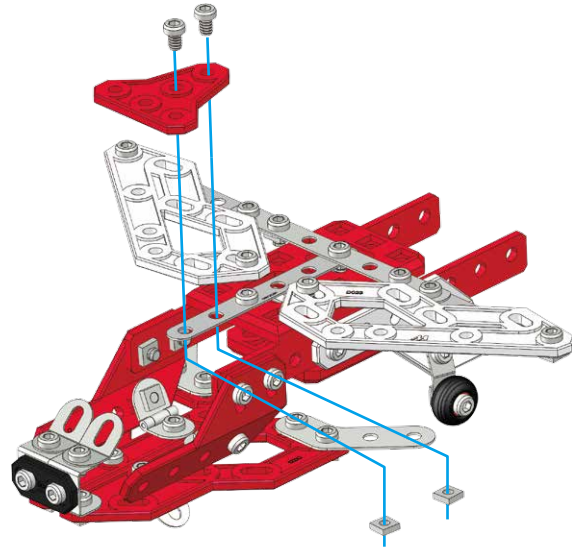

			x1
	S1	5,8 mm	x2
	S1	15/64"	x2









	S1	1:1
--	----	-----

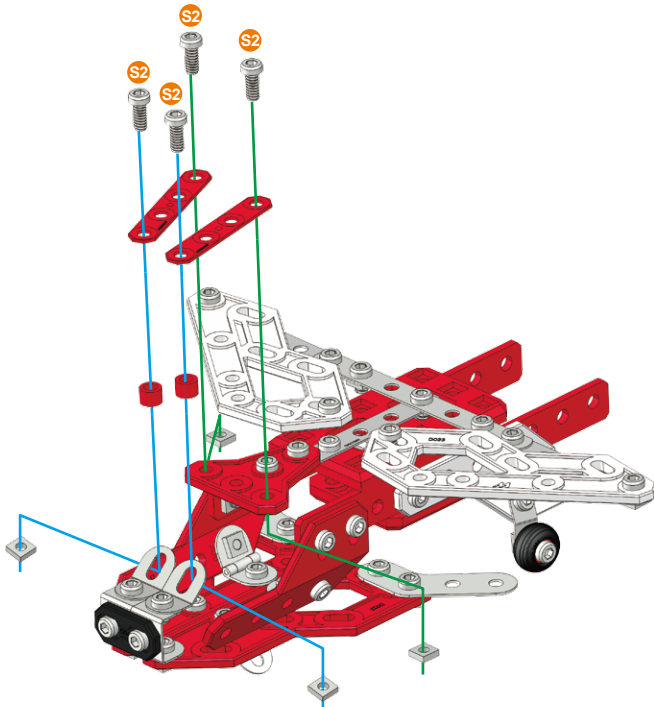

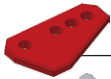



24

	x2		x4	1:1
	x4			
	x4			
	x2			

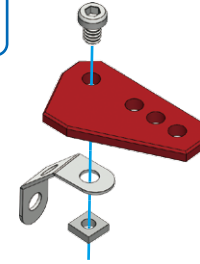
**25**



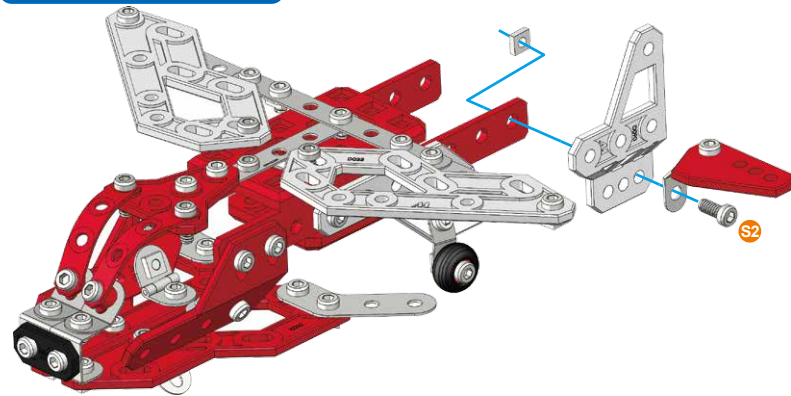

	x1		1:1
	x1		x1
	x1		x1

**26** ②④ + ②⑤ +

	x1		1:1
	x1		x1

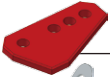



27

-  **x1**
-  **x1**
-  | 5,8 mm | **x1**
15/64"
-  **x1**

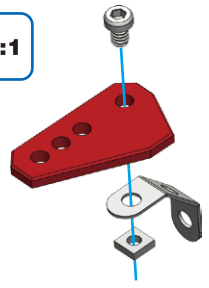
-  **S1** | **1:1**





29

-  | 63,5 mm | **x1**
2 31/64"
-  **x2**



28 (26) + (27) +

-  **x1**
-  | 9,5 mm | **x1**
3/8"
-  **x1**

-  **S2** | **1:1**
- 

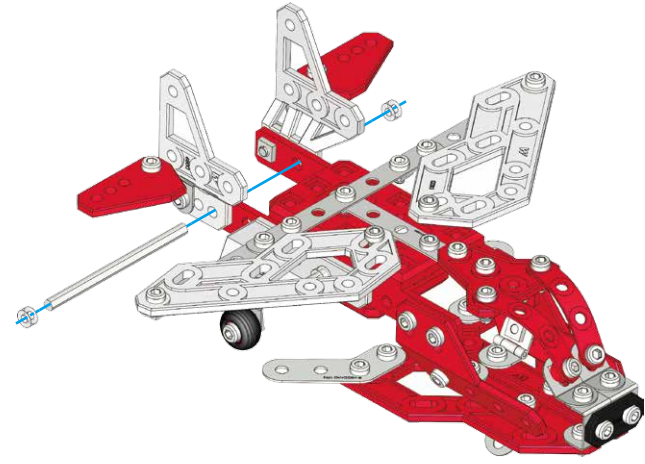
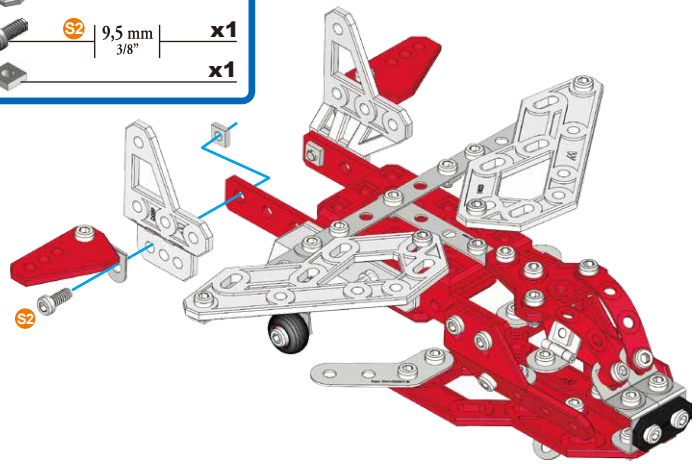

-  **1:1**