







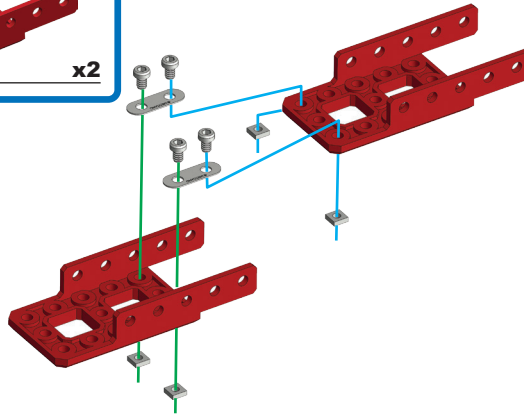
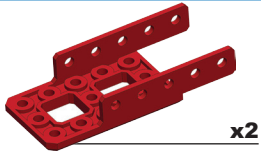

1

-  | 5.8 mm | x4
15/64"
-  | x4
-  | x2



2

-  | 9.5 mm | x2
3/8"
-  | x2
-  | x1

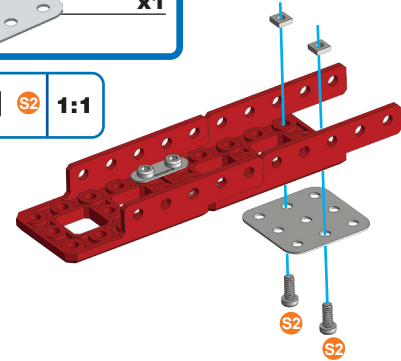

3

	9.5 mm 3/8"	x1
	12 mm 1/2"	x1
		x2
		x3
		x1
		x1

	S2	1:1
	S3	1:1

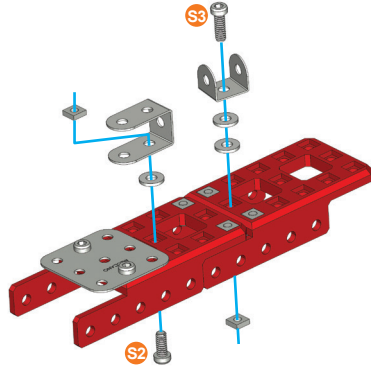

4

	5.8 mm 15/64"	x1
	9.5 mm 3/8"	x3
		x4
		x1
		x2
		x1

	S1	1:1
	S2	1:1

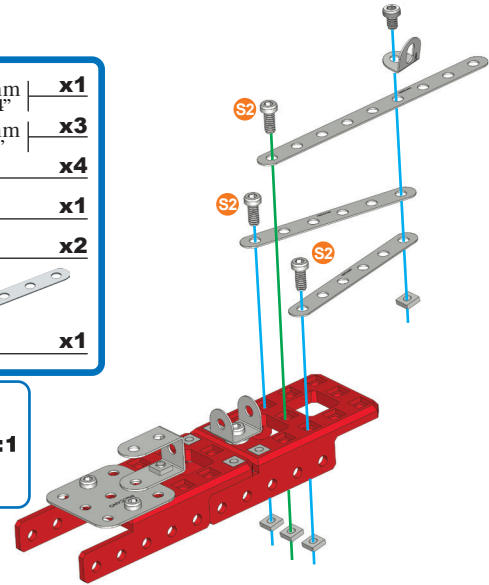

5

	5.8 mm 15/64"	x2		x2
		x1		x1

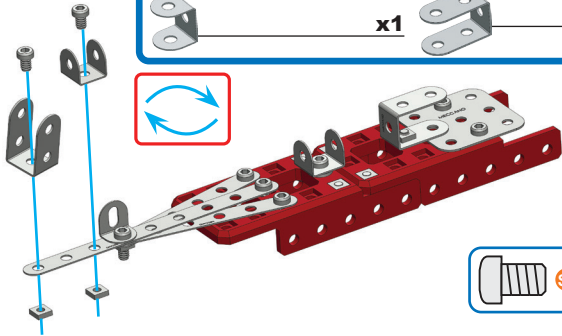

	S1	1:1
--	----	-----



6

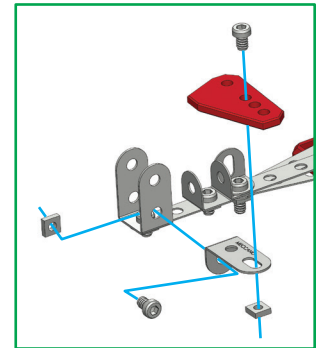
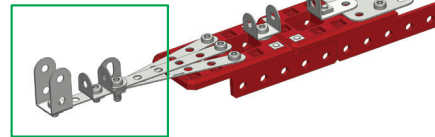

	5.8 mm 15/64"	x2		x2
		x1		x1

	S1	1:1
--	----	-----



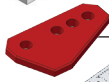
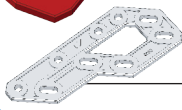



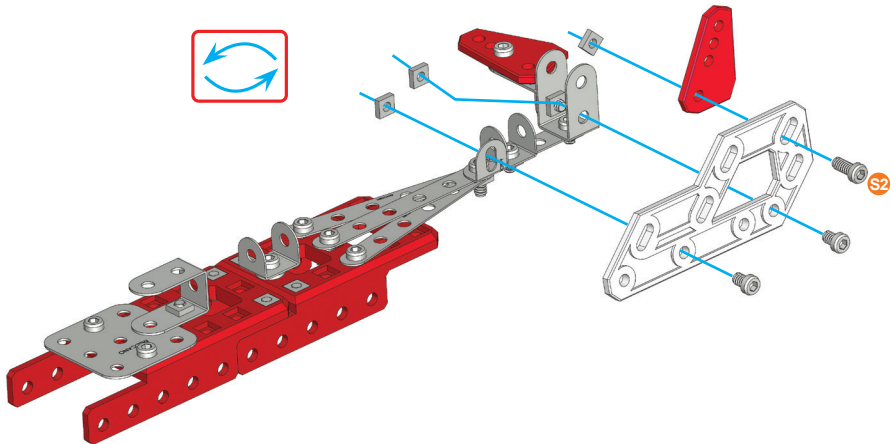

7

	S1	5,8 mm 15/64"	x2
	S2	9,5 mm 3/8"	x1
			x3
			x1
			x1

	S1	1:1
	S2	





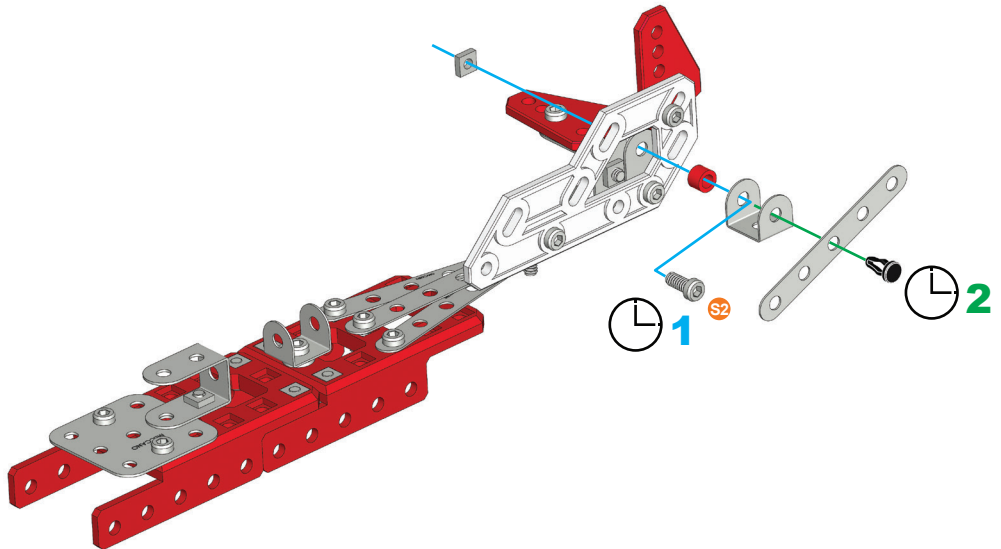

8

	S2	9,5 mm 3/8"	x1
			x1
		A338	x1
			x1
			x1
			x1

	S2	1:1
---	----	-----

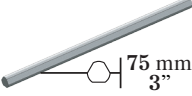
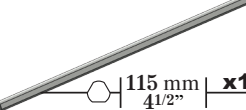



9

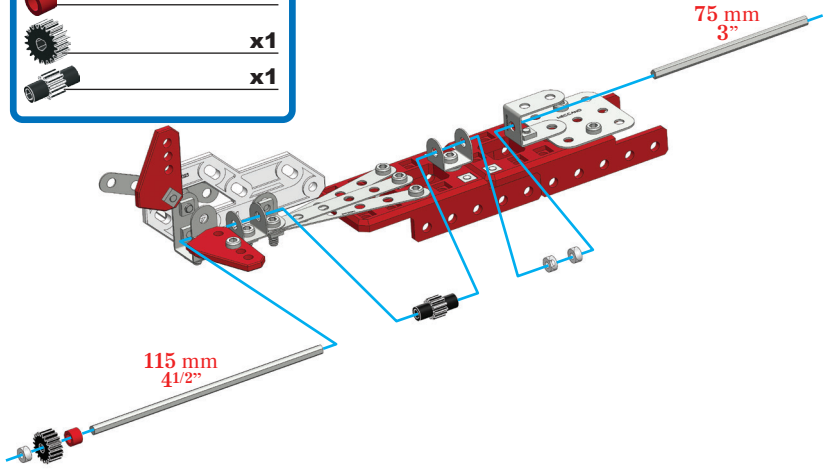
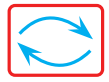







-  75 mm | 3" | x1
-  115 mm | 4 1/2" | x1
-  x3
-  A338x1
-  x1
-  x1

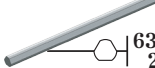

-   A338 | 1:1

-  | 1:1
-  | 1:1

10



-  63.5 mm | 2 3/4" | x1
-  A338x2
-  A238x1
-  x3
-  x2
-  x2
-  x2
-  x2

-   A338 | 1:1
-   A238 | 1:1

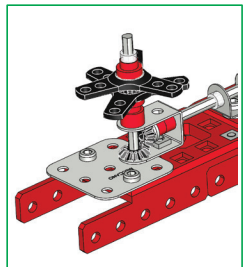
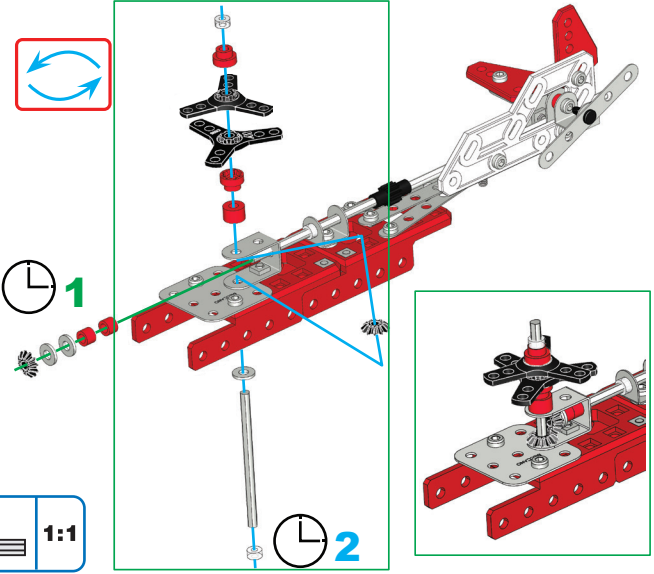
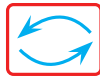
-  | 1:1





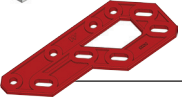

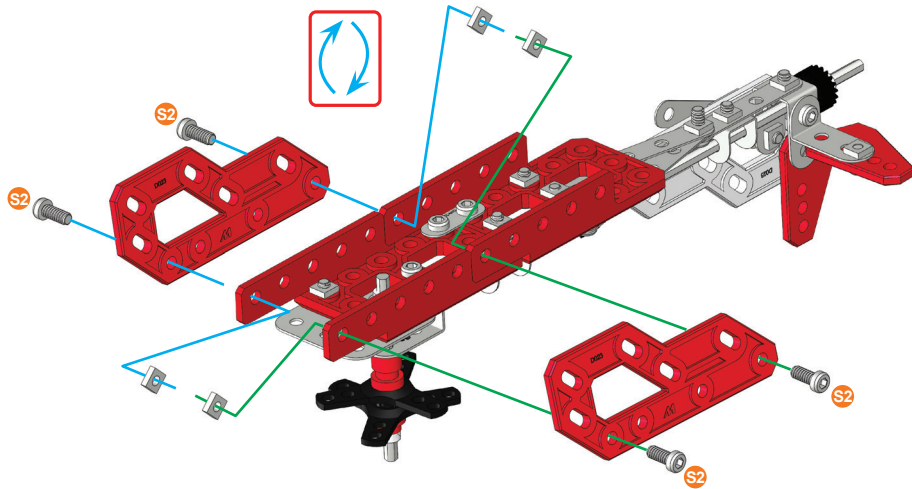

11

	9.5 mm 3/8"	x4
		x4
		x2

	1:1
---	-----





12

	5.8 mm 15/64"	x4
		x3
		x1
		x1
		x1
		x1

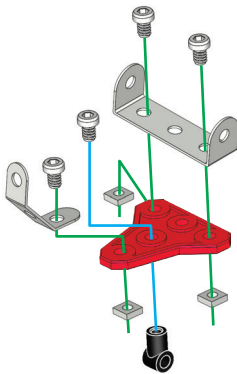
	1:1
---	-----





13 ⑪+⑫+

	5.8 mm 15/64"	x2
		x2

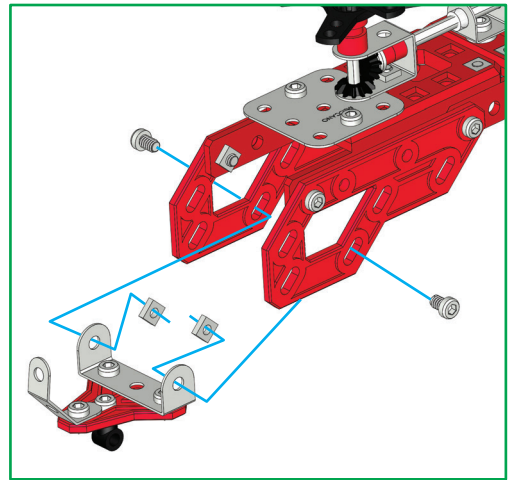
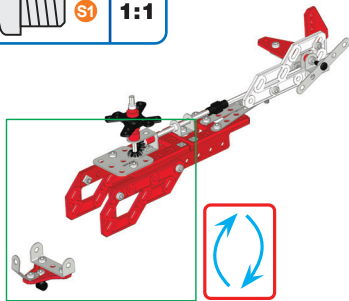
	1:1
---	-----







14

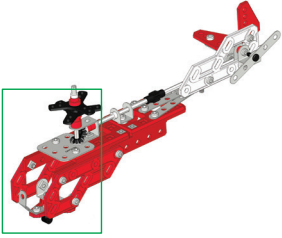
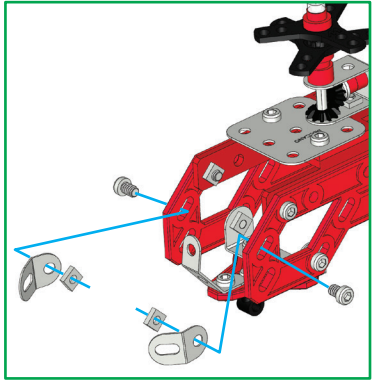



 S1	5.8 mm 15/64"	x2
		x2
		x2

 S1	1:1
--	-----





15

 S1	5.8 mm 15/64"	x1
 S2	9.5 mm 3/8"	x1
		x2
A338		x1
		x2
		x1

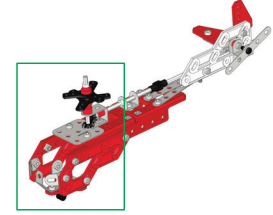
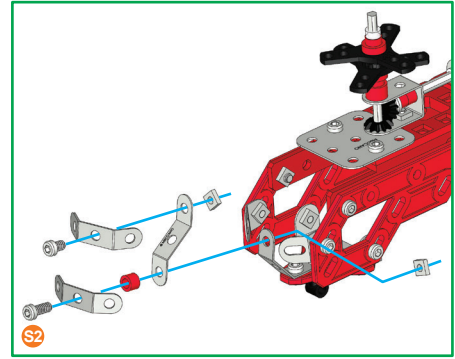
		A338	
 S2	1:1		
 S1			







16

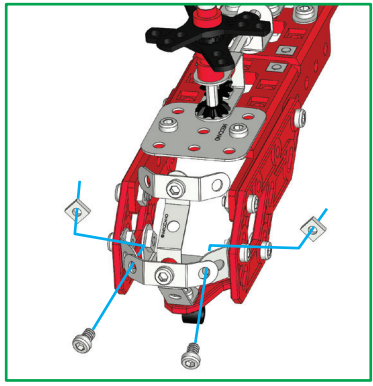
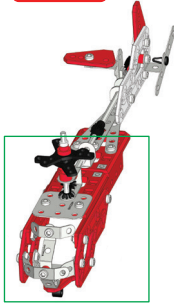

 S1	5.8 mm 15/64"	x2
		x2

 S1	1:1
---	-----





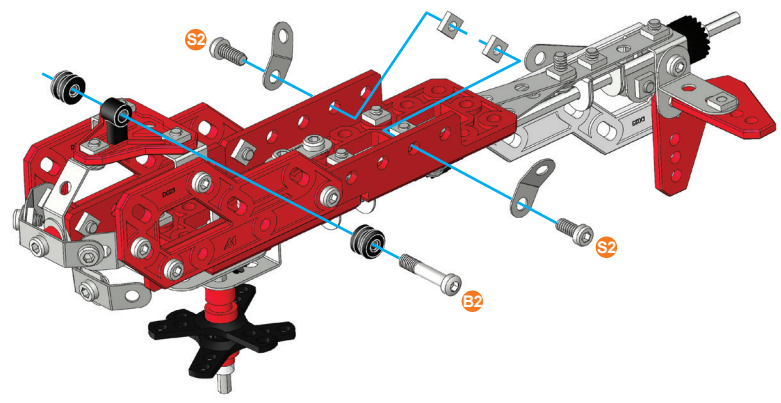

17

	S2	9,5 mm 3/8"	x2
	B2	19 mm 3/4"	x1
			x2
			x2
			x2

	S2	1:1
	B2	





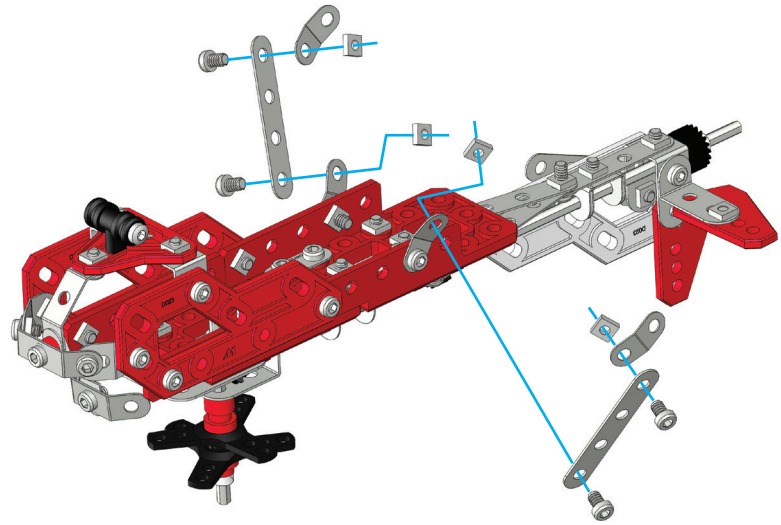

18

	S1	5,8 mm 15/64"	x4
			x4
			x2
			x2

	S1	1:1
--	----	-----





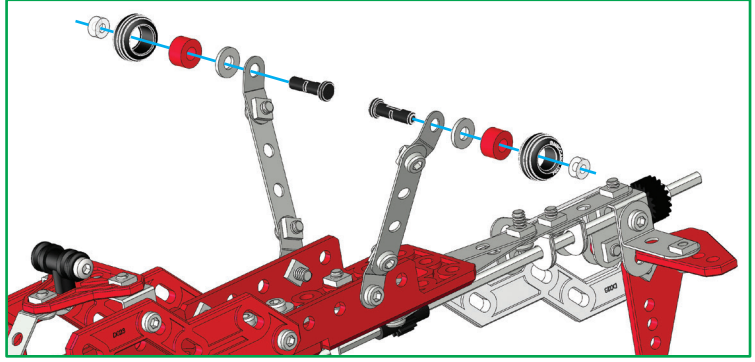
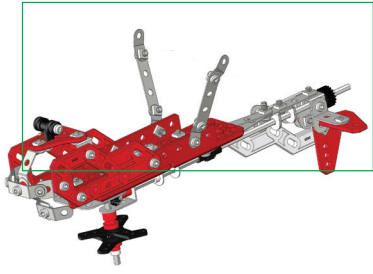

19

-  x2
-  **A238x2**
-  x2
-  x2
-  x2



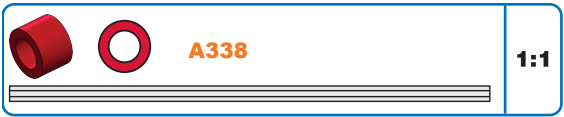
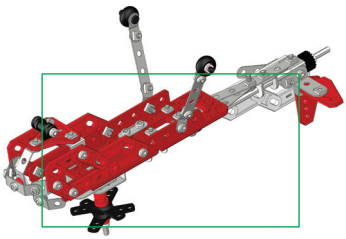
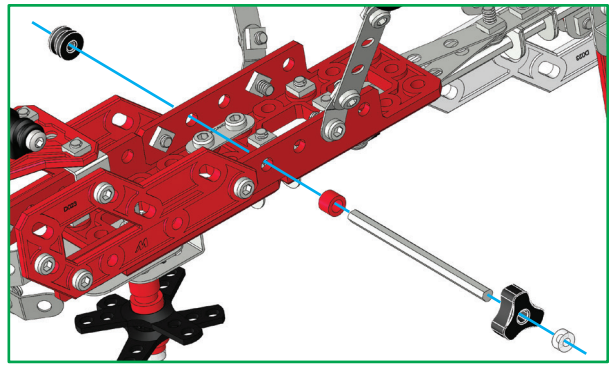

20

-  63.5 mm | 2 31/64" | x1
-  x1
-  **A338x1**
-  x1
-  x1



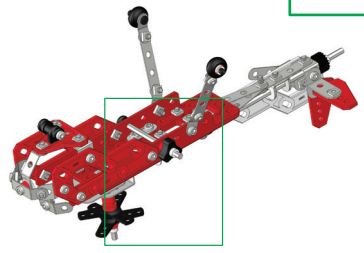
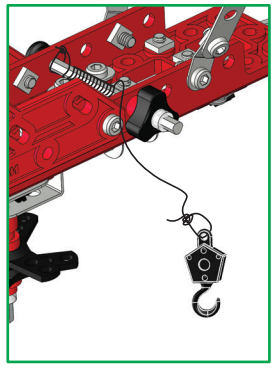

21

-  x1
-  x1



22

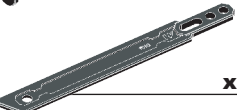

-  **S2** | 9.5 mm | **x3**
3/8"
-  **x3**
-  **x3**
-  **x3**

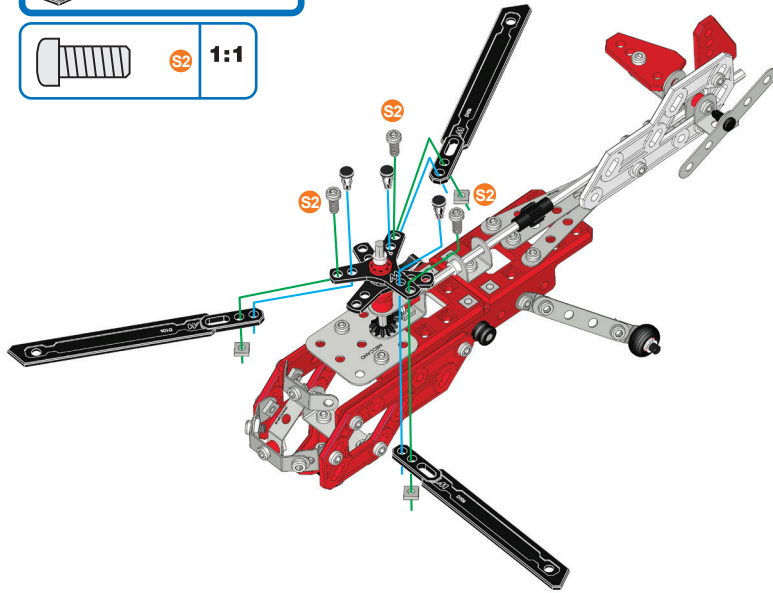

-  **S2** | **1:1**

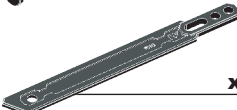

22

-  **S2** | 9.5 mm | **x3**
3/8"
-  **x3**
-  **x3**
-  **x3**



-  **S2** | **1:1**

