



F4U Corsair .60 ARF

ASSEMBLY MANUAL



Specifications

Wingspan:	65.25 in (1657mm)	Recommended Engines:	.61-.75 2-stroke
Wing Area:	752 sq in (48.5 sq dm)		.91-1.0 4-stroke
Length:	51.5 in (1308mm)	Radio:	5-channel w/6 servos
Weight:	7.5-.8.5 lb (3.4 kg-3.85 kg)		

Table of Contents

Table of Contents	2
Covering Colors	2
Contents of Kit	3
Required Radio and Engines	3
Additional Required Tools and Adhesives	4
Other Items Needed (not included in the kit)	4
Warning	4
Before Starting Assembly	5
Using the Manual	5
Warranty Information	5
Section 1: Joining the Wing Halves	6
Section 2: Attaching the Wing	10
Section 3: Installing the Horizontal Stabilizer	11
Section 4: Installing the Vertical Stabilizer	13
Section 5: Installing the Ailerons	16
Section 6: Installing the Elevators	17
Section 7: Installing the Rudder	19
Section 8: Retract Linkage Installation	22
Section 9: Engine Installation	25
Section 10: Throttle Pushrod Installation	26
Section 11: Fuel Tank Assembly	28
Section 12: Fuel Tank Installation	31
Section 13: Radio Installation	32
Section 14: Linkage Installation	38
Section 15: Cowling Installation	44
Section 16: Canopy and Decal Installation	47
Adjusting the Engine	48
Range Testing the Radio	49
Preflight at the Field	49
Control Throws and Center of Gravity	49
2003 Official AMA National Model Aircraft Safety Code	50

Covering Colors

- Midnight Blue HANU885
- Bright Yellow HANU872

Contents of Kit

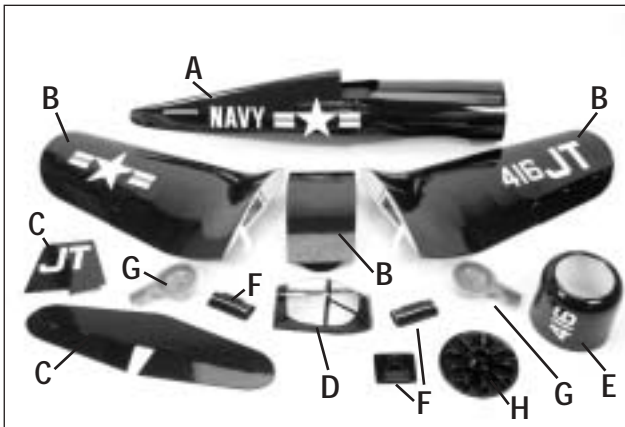

Large Parts

A. Fuselage	HAN2577
B. Wing Set w/Joiner and Ailerons	HAN2576
C. Tail Set	HAN2578
D. Canopy	HAN2586
E. Painted Cowl	HAN2579
F. Cockpit w/Radiator	HAN2585
G. Wheel Wells	HAN2589
H. Dummy Engine	HAN2587

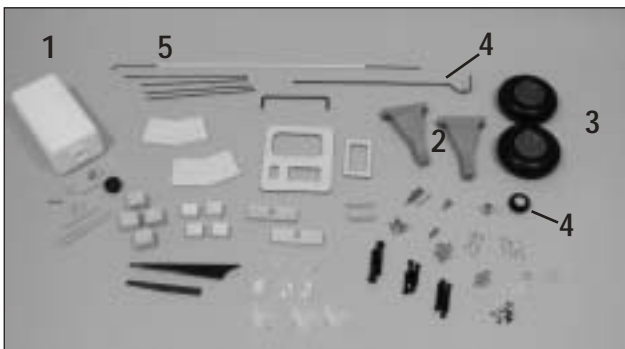

Small Parts

1. Fuel Tank Assembly	HAN2588
2. Engine Mount	HAN2033
3. Wheels	HAN2584
4. Tail Wheel Assembly	HAN2581
5. Pushrod Set	HAN2583

Additional items sold separately

Decal Set (not shown)	HAN2582
Retract Set	HAN2580

Required Radio and Engines

Radio Equipment

- 5-channel radio system (minimum)
- 5 standard servos (JRPS537 recommended or equivalent)
- 1 low-profile retract servo (JRPS703 recommended or equivalent)

Recommended JR™ Systems

- PCM10X
- XP8103
- X-378
- XP662
- XF631
- XF421EX



JR PCM 10X



JR XP8103



Evolution .61NT
EVOE0610



Saito 100 AAC
SAIE100

Other Items Needed (not included in the kit)

- Propeller
14x8 - Saito, 12x6 or 13x6 - Evolution
- Safety spinner for engine
HIGSPN008 - Saito, HIGSPN014 - Evolution
- 537 Standard Servo (JRPS537) (5) or equivalent
- 703 Low-Profile Retract Servo (JRPS703)
- Large servo Arm w/Screw (JRPA212)
- 9" Servo Lead Extension (JRPA097) (2)
- 12" Servo Lead Extension (JRPA098) (2)

Additional Required Tools and Adhesives

Tools

- Adjustable wrench
- Canopy Scissors (DYN2517)
- Drill
- Drill Bit: 1/16", 5/64", 3/32", 9/64",
5/32", 1/8", 7/32"
- Foam: 1/2"
- Hex Wrench: 3/16", 9/64" (BON10945 - Set)
- Hobby Knife (XAC3126)
- Phillips screwdriver (small)
- Pliers
- Square (MID1123)
- 11/32" socket wrench

Adhesives

- 6-Minute Epoxy (HAN8000)
- 30-Minute Epoxy (HAN8002)
- Thin CA (cyanoacrylate) Glue (PAAPT08)
- Thick CA (cyanoacrylate) Glue (PAAPT02)
- CA Remover/Debonder (PAAPT16)
- Pacer Z-42 Threadlock (PAAPT42)
- RCZ56 Canopy Glue (ZINJ5007)
- Masking Tape (MMM20901)

Other Required Items

- Epoxy Brushes (DUB345)
- Felt-Tipped Pen (PAR10400)
- File
- Fuel Tubing (AER1003)
- Measuring device (e.g. ruler, tape measure)
- Mixing Sticks for Epoxy (DUB346)
- Paper towels
- Petroleum jelly
- Rubbing alcohol
- Sanding bar
- Sandpaper (medium)
- String
- T-Pins (DUB252)
- Wax paper

Warning

An RC aircraft is not a toy! If misused, it can cause serious bodily harm and damage to property. Fly only in open areas, preferably at AMA (Academy of Model Aeronautics) approved flying sites, following all instructions included with your radio and engine.

Before Starting Assembly

Before beginning the assembly of the Corsair, remove each part from its bag for inspection. Closely inspect the fuselage, wing panels, rudder, and stabilizer for damage. If you find any damaged or missing parts, contact the place of purchase.

If you find any wrinkles in the covering, use a heat gun or covering iron to remove them. Use caution while working around areas where the colors overlap to prevent separating the colors.

Using the Manual

This manual is divided into sections to help make assembly easier to understand and to provide breaks between each major section. In addition, check boxes have been placed next to each step to keep track of each step completed. Steps with two boxes indicate that the step will require repeating, such as for a right or left wing panel, two servos, etc. Remember to take your time and follow the directions.

Warranty Information

Horizon Hobby, Inc. guarantees this kit to be free from defects in both material and workmanship at the date of purchase. This warranty does not cover any parts damage by use or modification. In no case shall Horizon Hobby's liability exceed the original cost of the purchased kit. Further, Horizon Hobby reserves the right to change or modify this warranty without notice.

In that Horizon Hobby has no control over the final assembly or material used for the final assembly, no liability shall be assumed nor accepted for any damage of the final user-assembled product. By the act of using the product, the user accepts all resulting liability.

Once assembly of the model has been started, you must contact Horizon Hobby, Inc. directly regarding any warranty question that you have. Please do not contact your local hobby shop regarding warranty issues, even if that is where you purchased it. This will enable Horizon to better answer your questions and service you in the event that you may need any assistance.

If the buyer is not prepared to accept the liability associated with the use of this product, the buyer is advised to return this kit immediately in new and unused condition to the place of purchase.

Horizon Hobby
4105 Fieldstone Road
Champaign, Illinois 61822
(877) 504-0233
www.horizonhobby.com

Section 1: Joining the Wing Halves

Required Parts

- Left and right wing panels
- Center wing panel
- Wing joiner (2)
- Wing dowels (2)

Required Tools and Adhesives

- Masking tape
- 30-minute epoxy
- Epoxy brush
- Mixing stick
- Rubbing alcohol
- Paper towels

Step 1

Pull the retract linkage to extend the retract. Make a slight bend in the linkage towards the bottom of the wing. This will make the alignment of the wire to the retract servo much easier later.

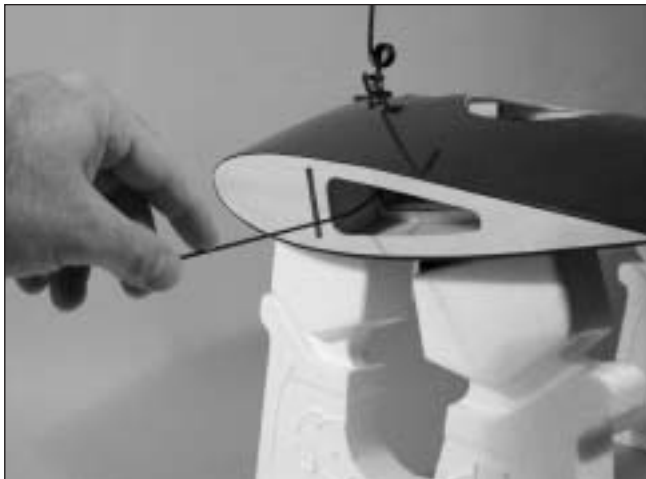

Step 2

Remove the tape from the string located in the outer wing panel. Tape the string to the retract linkage so it can be accessed later.

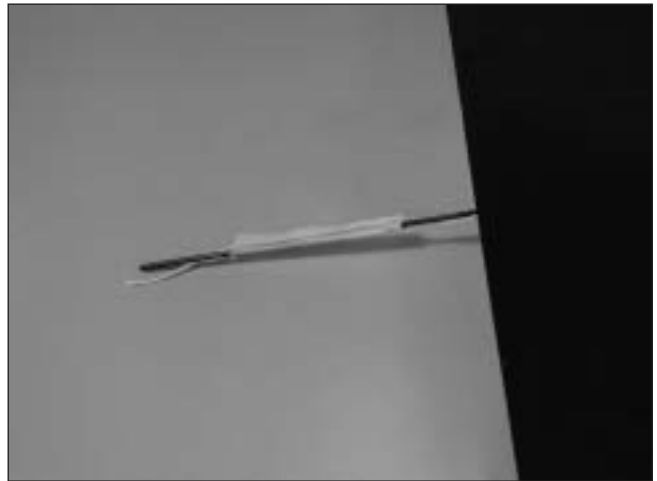

Note: Do not remove the string from the wing panel.

Step 3

Draw a centerline on the wing joiner as shown. The shorter side of the joiner will be inserted into the outer wing panel.

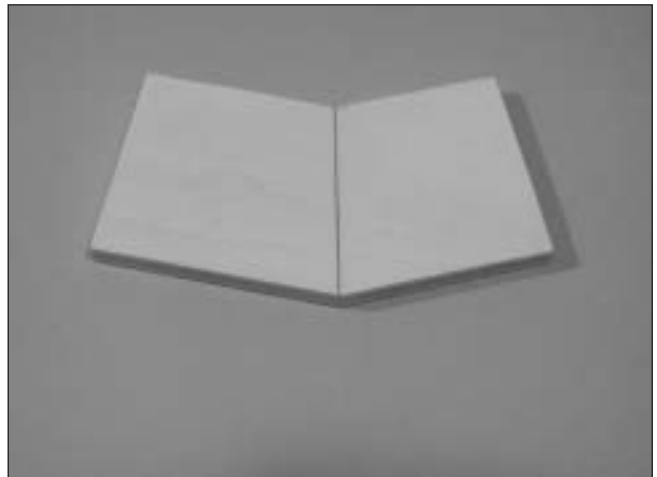

Section 1: Joining the Wing Halves

□ □ Step 4

Test the fit of the wing joiner into one of the outer wing panels. The joiner should slide into the panel with little resistance up to the line drawn on the joiner. Lightly sand the joiner as necessary to achieve a proper fit.

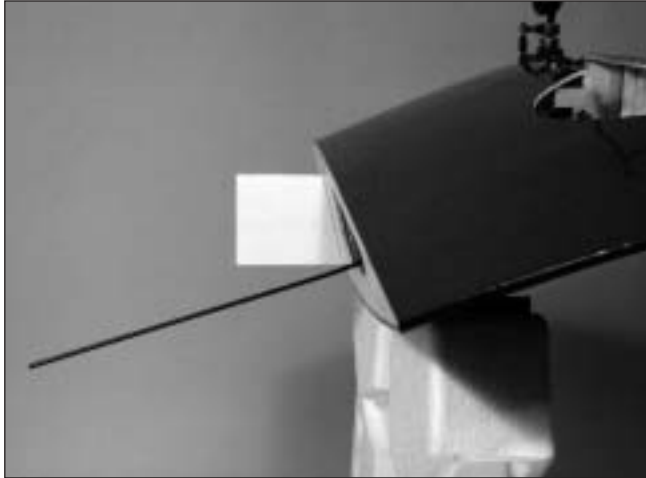

Note: The joiner will be angled towards the bottom of the wing.

□ □ Step 5

Test the fit of the wing joiner into the outer wing panel. The joiner should slide into the panel with little resistance up to the line drawn on the joiner. Lightly sand the joiner as necessary to achieve a proper fit.



Note: The joiner will be angled towards the bottom of the wing.

□ □ Step 6

Use a hobby knife to remove the covering from the opening in the center panel for the retract servo.



□ □ Step 7

Without using any glue, test fit the wing panel and center panel together using the wing joiner. Guide the retract linkage into the center panel so it is visible in the opening for the retract servo. The panels must fit together without any gaps top or bottom. If any gaps do exist, use a sanding bar to lightly sand the root ribs of both panels until the panels fit together perfectly.



Note: Read through the remaining steps of this section before mixing any epoxy.

Section 1: Joining the Wing Halves

Hint: It is extremely important to use plenty of epoxy when joining the wing panels. It will also be helpful to use wax paper under the wing joint to avoid gluing the wing to your work surface.

Step 8

Mix approximately 1 ounce of 30-minute epoxy. Using an epoxy brush, apply a generous amount of epoxy to the wing joiner cavity of the outer wing panel.



Step 9

Completely coat the short half of the wing joiner with epoxy. Be sure to apply epoxy to the top and bottom of the joiner also. Insert the epoxy-coated side of the joiner into the outer wing joiner cavity up to the mark on the joiner. If you have used enough epoxy, it will ooze out of the cavity as the joiner is installed. Remove any excess epoxy using a paper towel and rubbing alcohol.



Step 10

Apply a generous amount of epoxy to the joiner cavity and root rib of the center wing panel.



Section 1: Joining the Wing Halves

Step 11

Apply epoxy to the exposed portion of the wing joiner.



Step 12

Apply epoxy to root wing rib of both panels.

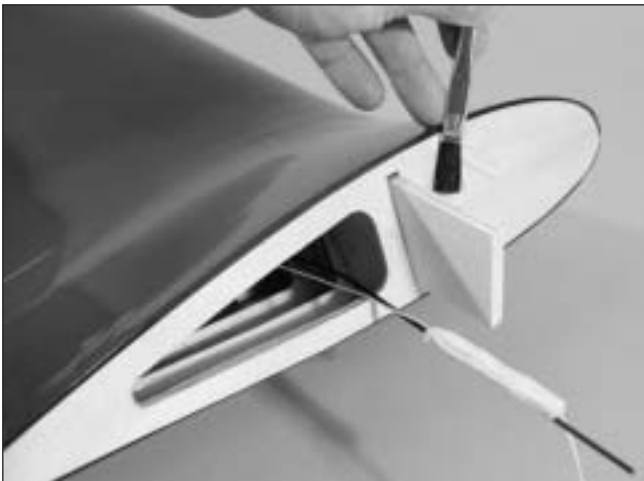

Step 13

Carefully slide the wing panels together. Apply enough pressure to firmly seat the two wing panels together, causing any excess epoxy to ooze out from between the panels. Use rubbing alcohol and a paper towel to remove the excess epoxy. Check to make sure there are no visible gaps between the panels.

Step 14

Use masking tape to securely hold the wing panels together. Allow the epoxy to fully cure before continuing to the next section.



Step 15

Repeat Steps 1 through 14 for the remaining wing panel.

Step 16

Locate the two 1/4" x 1/4" wing dowels. Use 30-minute epoxy to glue the wing dowels into the center panel. The dowels should be inserted so that 7/16" of the dowel is left exposed in front of the leading edge.

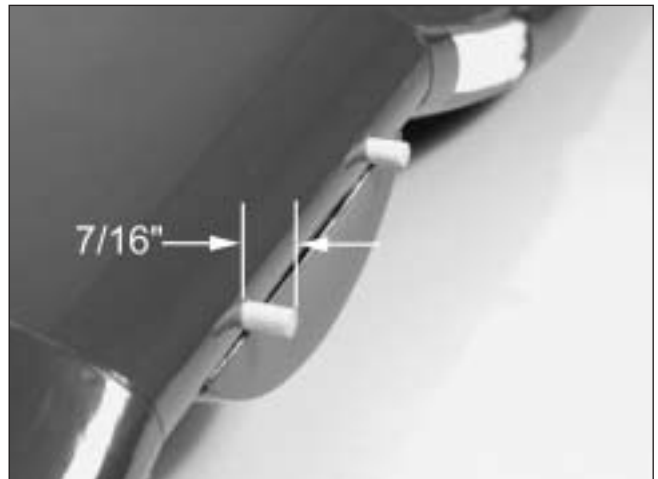

Section 2: Attaching the Wing

Required Parts

- Assembled wing
- Fuselage
- 1/4-20 blind nut (2)
- 1/4" washer (2)
- 1/4-20 x 1 1/2" socket head bolt (2)

Required Tools and Adhesives

- 30-minute epoxy
- Pliers
- Hex Wrench: 3/16"

Step 1

Locate the two 1/4-20 blind nuts. Mix a small amount of 30-minute epoxy and apply it to the barbs of the blind nut. Use pliers to install the blind nut from the inside of the fuselage.



Note: Make sure no epoxy gets into the threads of the blind nut.

Step 2

Use a sharp hobby knife to remove the covering from the bolt holes on the top of the wing.



Step 3

Use the two 1/4 x 1 1/2" socket head bolts and 1/4" washers to attach the wing to the fuselage.



Step 4

Measure the distance between a point centered at the rear of the fuselage and each wing tip. The measurement will be equal if the wing is aligned correctly. If the measurement is not the same, slightly oval the hole for the wing bolts until an equal measurement is achieved.

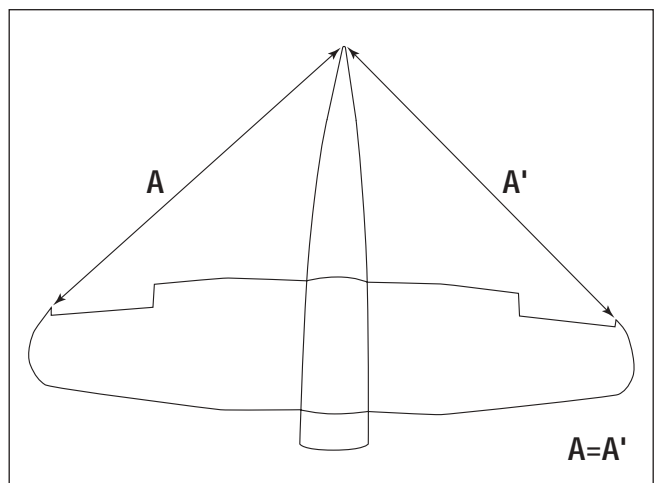

Section 3: Installing the Horizontal Stabilizer

Required Parts

- Assembled wing
- Fuselage
- Stabilizer
- Elevator joiner wire

Required Tools and Adhesives

- Hobby knife
- Felt-tipped pen
- Ruler
- 30-minute epoxy

Step 1

Slide the stab into the fuselage, making sure the stabilizer is as far forward as possible. Center the stab in the opening by measuring the distance from the fuselage to each tip. The stab is aligned when both measurements are identical.

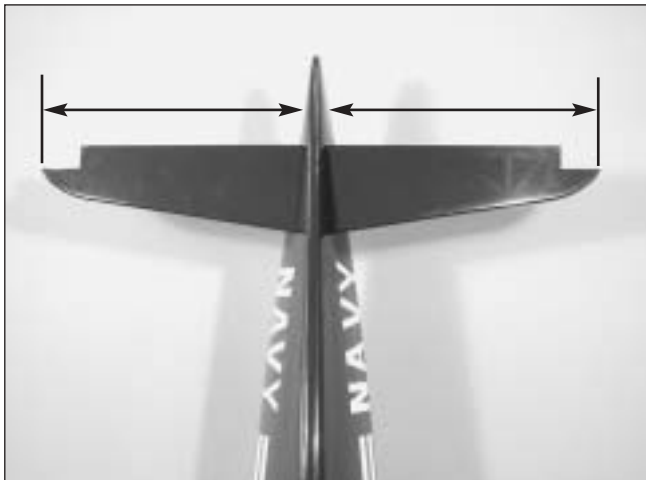

Step 2

Check the distance from each stab tip to each wing tip. These measurements must be equal for the stab to be aligned.

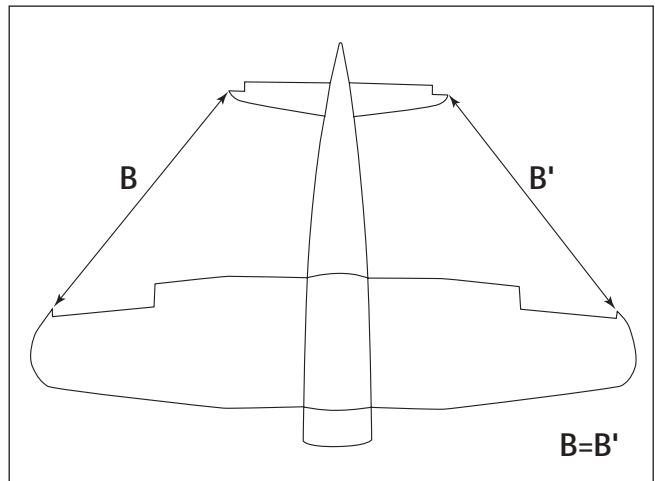

Step 3

Check to make sure the wing and stabilizer are parallel. If they are not, lightly sand the opening in the fuselage for the stab until the stab is parallel to the wing.

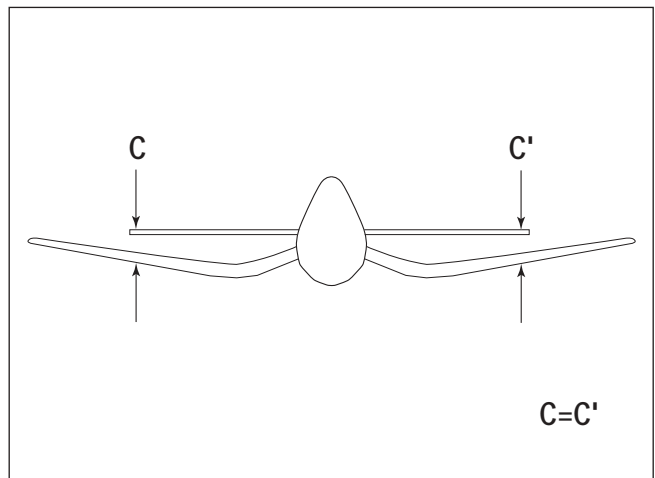

Section 3: Installing the Horizontal Stabilizer

Step 4

After verifying the alignment of the stabilizer, use a felt-tipped pen to trace the outline of the fuselage on the stab.



Step 5

Remove the stab and use a hobby knife with a new blade to remove the covering 1/16" inside the lines just drawn. Use rubbing alcohol and a paper towel to remove the lines once they are no longer needed.

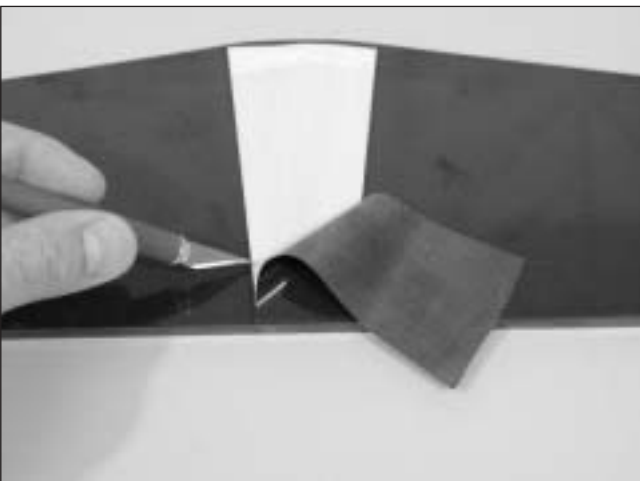

Note: Use care not to cut into the underlying wood and weaken the structure. Doing so could cause the stab to fail in flight, resulting in the loss of your airplane.

Step 6

Slide the elevator joiner wire into the slot for the stabilizer. Slide the stabilizer partially back into the slot.



Step 7

Mix 1/2 ounce of 30-minute epoxy. Apply epoxy to the top and bottom of the exposed wood of the stabilizer. Slide the stabilizer the rest of the way into the slot in the fuselage. Double-check the alignment to verify it's correct. Remove any excess epoxy using a paper towel and rubbing alcohol. Allow the epoxy to fully cure before continuing.



Section 4: Installing the Vertical Stabilizer

Required Parts

- Fuselage assembly
- Tail wheel wire
- Tail wheel wire support bracket
- Fin
- Steering control arm

Required Tools and Adhesives

- 30-minute epoxy
- Square
- Pliers
- 6-minute epoxy
- Hobby knife
- Ruler

Step 1

Remove the covering from the top of the fuselage for the vertical fin and from the bottom of the fuselage for the tail wheel wire.

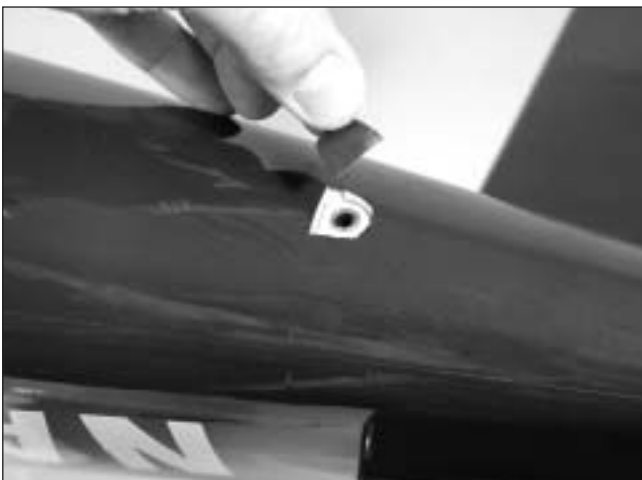

Step 2

Locate the tail wheel wire. Slide the steering control arm onto the wire as shown.

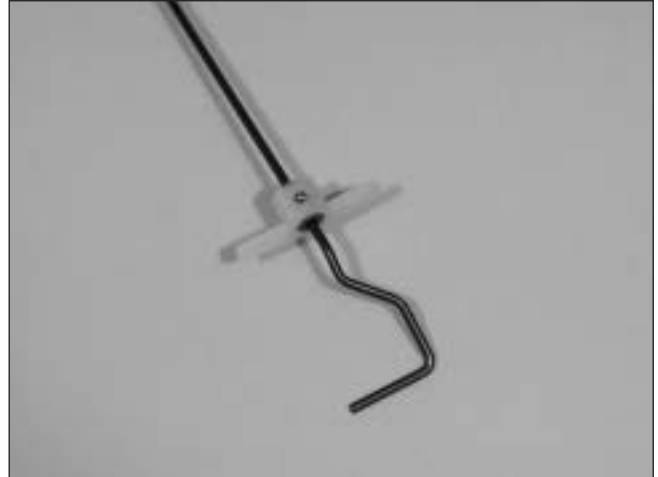

Step 3

Test fit the fin to the fuselage. Slide the fin as far forward in the slot as possible to provide clearance for the tail wheel wire. Trace the outline of the fuselage onto the fin using a felt-tipped pen.



Section 4: Installing the Vertical Stabilizer

Step 4

Remove the fin and use a hobby knife with a new blade to remove the covering 1/16" below the lines just drawn. Use rubbing alcohol and a paper towel to remove the lines once they are no longer needed.



Note: Use care not to cut into the underlying wood and weaken the structure. Doing so could cause the fin to fail in flight, resulting in the loss of your airplane.

Step 5

Locate the tail wheel wire support bracket and lightly sand the bracket using medium sandpaper.

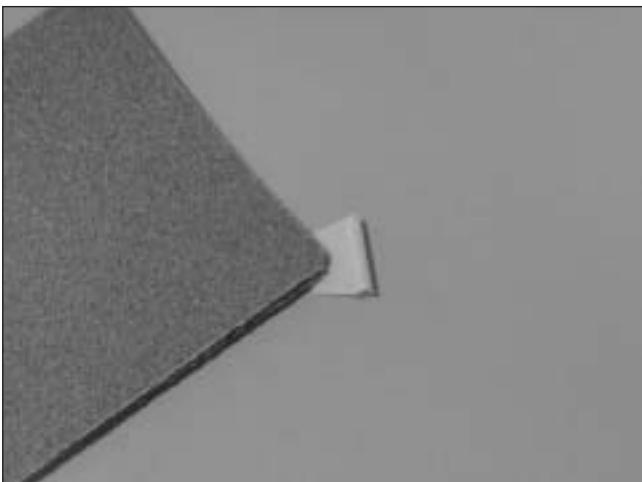

Step 6

Cut a slot in the bottom of the aft edge of the fin for the bracket. The slot must be on the centerline of the fin (hinge line). Use a small amount of 6-minute epoxy to glue the bracket into position. Make sure epoxy does not get into the hole in the bracket.



Step 7

Slide the fin back into the fuselage. Check the alignment of the fin to the stabilizer using a square. The fin must be 90 degrees to the stabilizer when properly aligned. If not, carefully sand the bottom of the fin to provide the clearance to align the fin.



Section 4: Installing the Vertical Stabilizer

□ Step 8

Mix 1/2 ounce of 30-minute epoxy. Apply the epoxy to both the exposed wood on the fin and the slot in the fuselage. Use care not to get epoxy in the tail wheel wire support bracket. Insert the fin and use tape to hold the fin in position until the epoxy fully cures.



Note: Check the alignment of the fin periodically to make sure it isn't moving while the epoxy cures.

□ Step 9

Slide the tail gear wire through the tube inside the fuselage and through the tail gear wire support bracket from the bottom of the fuselage. Slide it in until the distance between the bottom of the fuselage and bend for the wheel is $1\frac{7}{8}$ ".

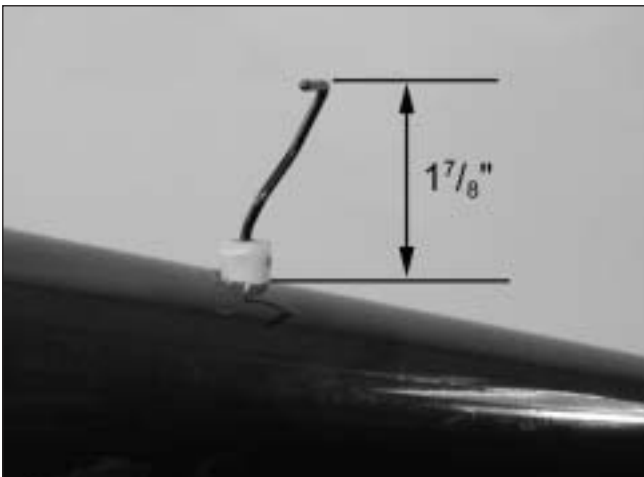

□ Step 10

Measure 3/4" up from the fuselage and mark the tail wheel wire. Position the wire so the tail wheel will be parallel to the runway. Make a 90-degree bend in the wire at the mark so the wire will extend into the rudder.

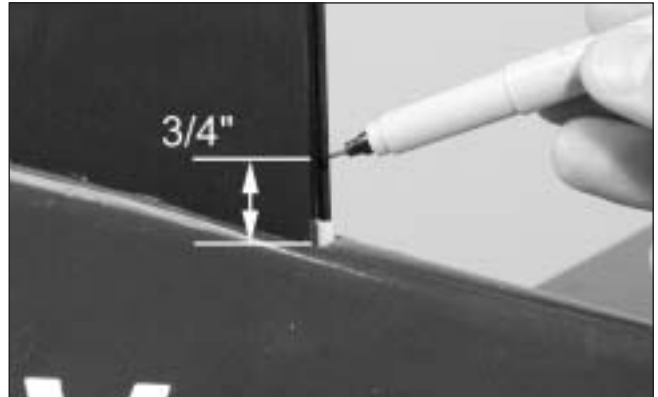

□ Step 11

Cut the excess wire so only 1" extends past the rear edge of the fin.

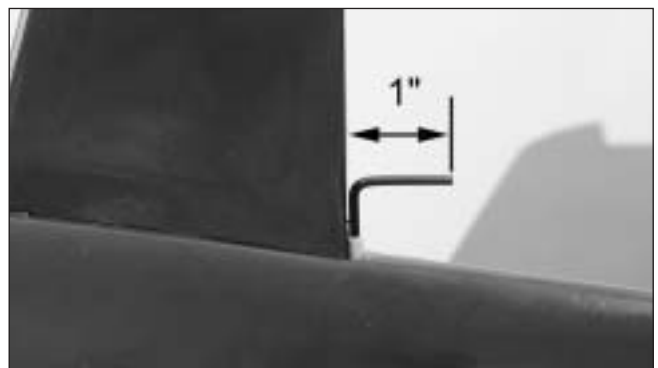

Section 5: Installing the Ailerons

Required Parts

- Wing
- CA hinges (6)
- Aileron (left and right)

Required Tools and Adhesives

- Thin CA
- T-Pins

Step 1

Locate three CA hinges. Place a T-pin in the center of each hinge.

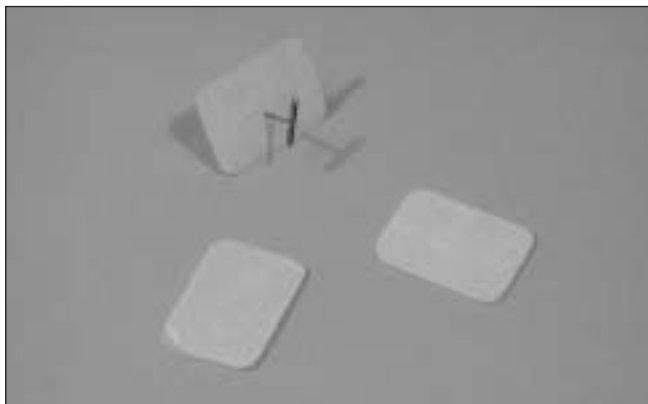

Step 2

Place the hinges in the precut slots in the aileron. The T-pin will rest against the leading edge of the aileron when installed correctly.



Step 3

Slide the aileron and wing together. The gap between the leading edge of the aileron and wing should be a maximum of approximately 1/64". Check to make sure the gap at both ends of the aileron are equal and that the aileron can move without rubbing on the wing.



Note: Do not use CA accelerator during the hinging process. The CA must be allowed to soak into the hinge to provide the best bond. Using accelerator will not provide enough time for this process.

Step 4

Remove the T-Pins and move the aileron to provide the best access to the hinge. Apply thin CA to each hinge. Make sure the hinge is fully saturated with CA. Use a paper towel and CA remover/debonder to clean up any excess CA from the wing and/or aileron. Make sure to apply CA to both sides of the hinges.



Section 5: Installing the Ailerons

Step 5

Firmly grasp the wing and aileron and gently pull on the aileron to ensure the hinges are secure and cannot be pulled apart. Use caution when gripping the wing and aileron to avoid crushing the structure.

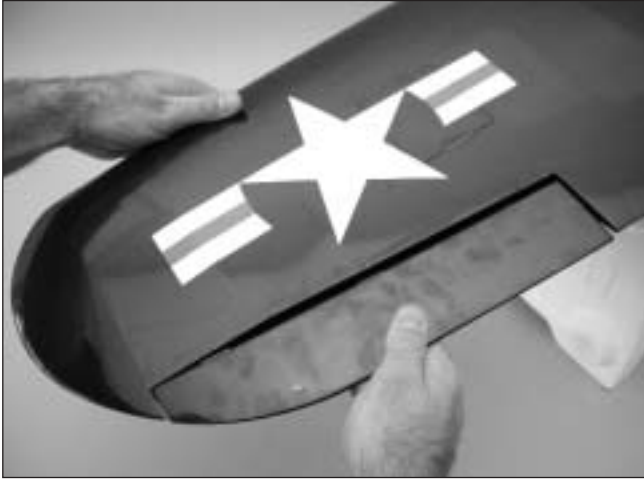

Step 6

Work the aileron up and down several times to work in the hinges and check for proper movement.

Step 7

Repeat Steps 1 through 6 for the remaining aileron.

Section 6: Installing the Elevators

Required Parts

- Fuselage assembly
- Elevator joiner wire
- CA hinge (6)
- Elevator (left and right)

Required Tools and Adhesives

- Thin CA
- T-pins
- 30-minute epoxy
- Medium sandpaper
- Drill
- Drill Bit: 9/64"

Step 1

Locate one of the elevator halves. Remove the covering from the slot in the elevator. Measure in 3/4" from the inside edge of the elevator and drill a 9/64" hole in the elevator that is 1" deep for the elevator joiner wire.

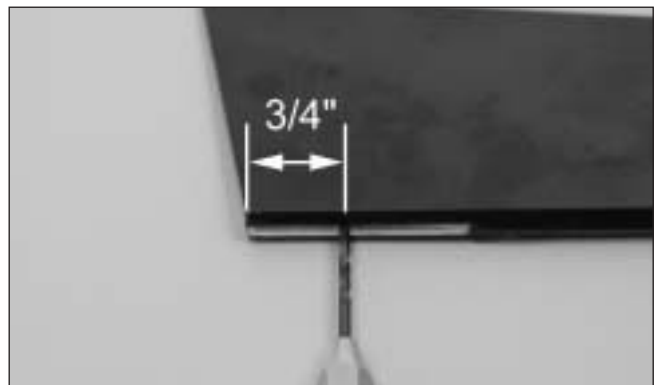

Section 5: Installing the Ailerons

□ □ Step 2

Locate three CA hinges. Place a T-pin in the center of the hinges. Place the hinges into the elevator half.



□ □ Step 3

Test fit the elevator and stab together. The elevator joiner wire will be inserted into the hole drilled in Step 1.



□ □ Step 4

Mix 1/2 ounce of 30-minute epoxy and apply it to the groove and hole in the elevator half. Insert the elevator joiner wire. Remove any excess epoxy using rubbing alcohol and a paper towel.



Note: You can combine the previous step with the following step if you like. This will hold the elevator in position while the epoxy cures.

□ □ Step 5

Check to make sure the elevator moves freely. It should not rub against the stabilizer at the tip. Check to make sure the hinge gap between the elevator and stabilizer is roughly 1/64". Apply thin CA to both sides of the hinge. Make sure to saturate the hinge and don't use accelerator.



□ □ Step 6

Once the CA and epoxy have fully cured, gently pull on the elevator and stab to make sure the hinges are well glued. Flex the elevators a few times to break in the hinges.



Section 5: Installing the Ailerons

Step 7

Hold the remaining elevator in position against the stabilizer. Mark the location of the elevator joiner wire onto the elevator.



Step 8

Drill the location marked in the previous step using a 9/64" drill bit.

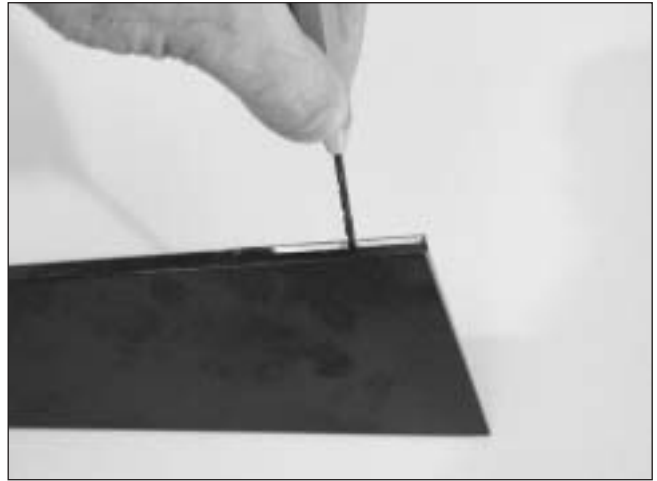

Step 9

Repeat Steps 2 through 6 to install the remaining elevator half.

Section 7: Installing the Rudder

Required Parts

- Fuselage assembly
- Rudder
- CA hinge (3)

Required Tools and Adhesives

- Thin CA
- T-pins
- 30-minute epoxy
- Medium sandpaper
- Drill
- Drill Bit: 1/8"

Step 1

Hold the rudder in position against the fin. Mark the location of the tail wheel wire onto the rudder.



Section 7: Installing the Rudder

Step 2

Drill the location marked in the previous step using a 1/8" drill bit.



Step 3

Use a hobby knife to cut a groove for the tail wheel wire into the leading edge of the fin from the hole to the bottom of the rudder. Also cut a small notch to allow clearance for the tail wheel wire support bracket.



Step 4

Use medium sandpaper to roughen the portion of the tail wheel wire that will be inserted in the rudder.



Step 5

Locate two CA hinges and place a T-pin in the center of each hinge. Place the hinges into the rudder.

Step 6

Test fit the rudder to the fin and tail wheel wire. The gap between the rudder and fin should be a maximum of approximately 1/64".



Step 7

Check the movement of the rudder to make sure it clears the fin.

Step 8

Remove the rudder from the fin. Mix 1/2 ounce of 30-minute epoxy and apply it to the groove and hole in the rudder. Insert the rudder control rod. Remove any excess epoxy using rubbing alcohol and a paper towel.

Note: You can combine the previous step with the following step if you like. This will hold the rudder in position while the epoxy cures.

Important: Do not let epoxy get into the tail wheel wire support bracket.

Step 9

Check to make sure the rudder moves freely. Apply thin CA to both sides of the hinge. Make sure to saturate the hinge and don't use accelerator.

Section 7: Installing the Rudder

Step 10

Once the CA and epoxy have fully cured, gently pull on the fin and rudder to make sure the hinges are well glued. Flex the rudder a few times to break in the hinges.



Step 11

Align the rudder with the fin. Position the rudder lower trim piece onto the fuselage directly below the rudder. Trace the outline of the trim piece onto the fuselage.



Step 12

Remove the covering from the fuselage and the bottom of the trim piece.

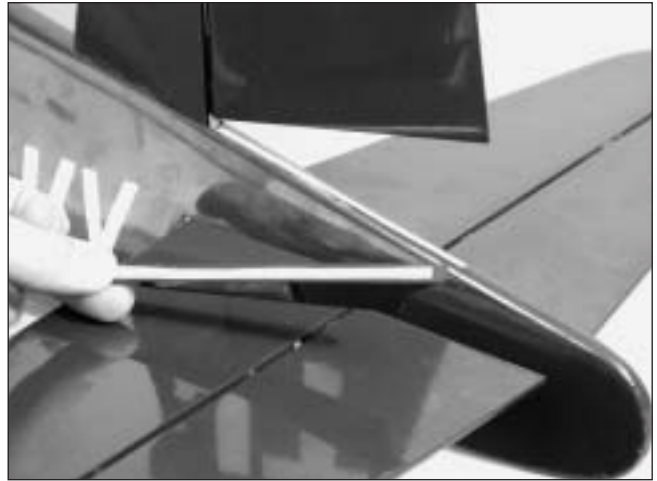

Step 13

Use medium CA to glue the trim piece onto the fuselage.



Section 8: Retract Linkage Installation

Required Parts

- Quick connector (2)
- 3mm set screw (2)
- 3 1/4" main wheel (2)
- 5/32" wheel collar (2)
- Retract servo tray
- 3mm set screw (2)
- Retract servo tray mount (2)
- Quick connector washer (2)
- Quick connector retainer (2)

Required Tools and Adhesives

- 6-minute epoxy
- Thick CA
- Retract Servo (JRPS703)
- Hobby knife
- Drill
- Drill Bit: 1/16", 5/64"
- Hex wrench (included in kit)

Step 1

Use a sharp hobby knife to remove the covering for the aileron servo extensions will. Pass the strings for the aileron servos through the holes and tape them to the top of the wing.

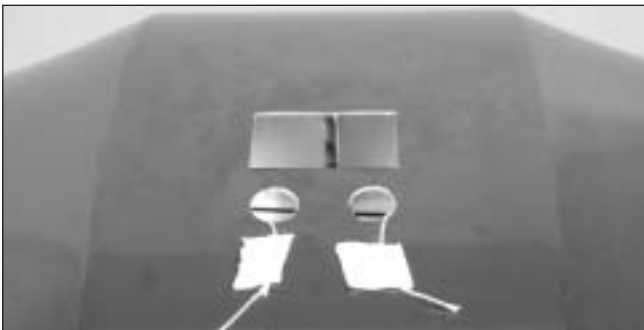

Step 2

Use 6-minute epoxy to glue the two retract servo tray mounts into the wing as shown.

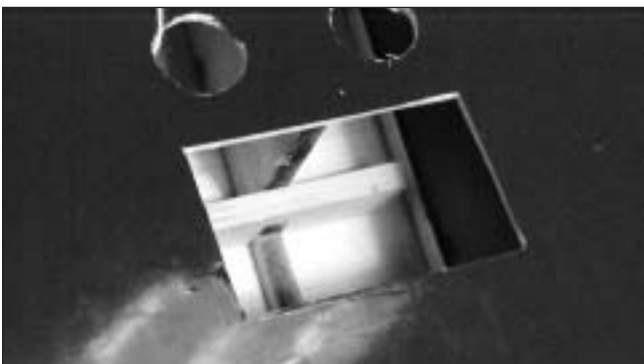

Step 3

Locate the retract servo tray. Use 6-minute epoxy to glue the servo tray into position.

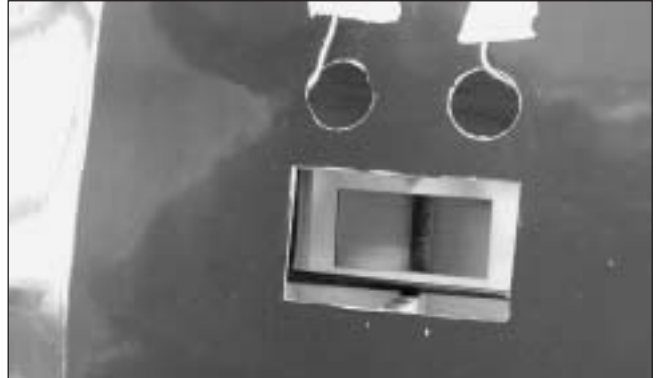

Step 4

Install a low-profile retract servo in the servo tray using the hardware provided with the servo. Prevent splitting the servo tray by drilling 1/16" holes for the servo mounting screws.



Step 5

Select a servo arm that has a distance of 1" between equally spaced holes as shown.

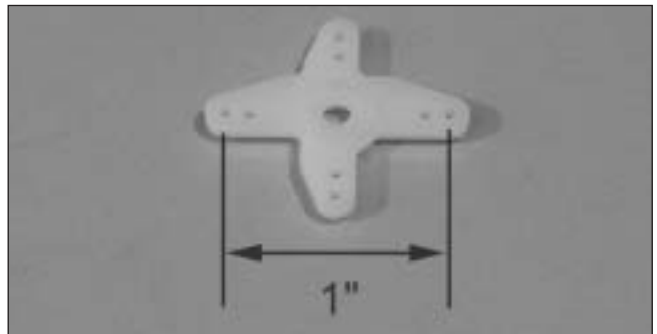

Section 8: Retract Linkage Installation

□ Step 6

Use a 5/64" drill bit to drill the appropriate holes in the arm.



□ Step 7

Attach two quick connectors to the servo arm using quick connector washers and retainers.



□ Step 8

Connect the retract servo to your radio system and electronically move the servo to the retracted position. Slide the retract control wires through the quick connectors as shown and secure the servo arm to the retract servo.

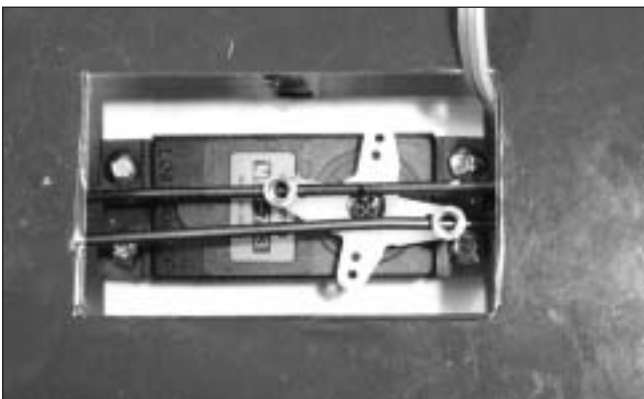

□ Step 9

With the retract servo in the retracted position, push the retract linkage to manually retract the landing gear. Install 3mm set screws into the quick connectors and tighten them to secure the retract linkage.

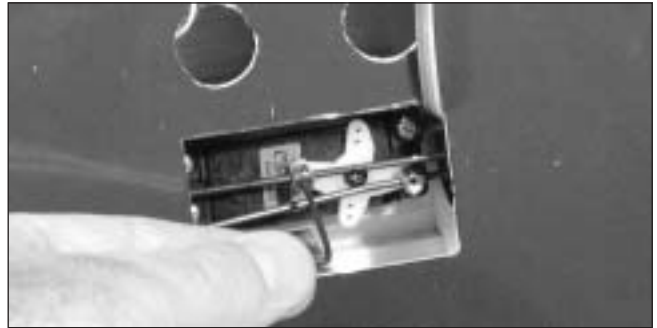

□ Step 10

It is important to check the actuation of the retracts. Make sure they lock in both the up and down positions by pulling or pushing on the retract. The linkage will not flex when set up correctly. Make any necessary adjustments to the linkages as necessary for proper operation of the retracts. The servo must not have a load on it when the retracts are in the locked position, either up or down.



Section 8: Retract Linkage Installation

Hint: Adjustments and fine tuning can also be made to the retract linkages from inside the wheel wells.

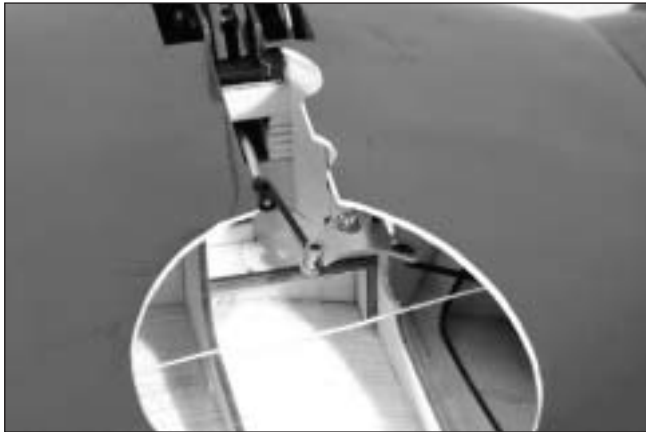

□ □ Step 11

Install the wheel wells after adjusting the retracts. Roughen the bottom side of the well and surrounding covering using medium sandpaper. Glue the wells using 6-minute epoxy.



Hint: Use clear tape and tape the wells into position when flying from rough surfaces.

□ □ Step 12

Install a wheel and two wheel collars on the main landing gear. The order of items is 5/32" wheel collar, wheel, and then another wheel collar. Secure the collars using the 3mm set screws.



□ □ Step 13

Physically check to make sure the retract does not move fore or aft by moving the strut as shown in Step 10. Tighten the adjustment screw in the front of the retract to eliminate any play when in the down and locked position.

Note: Do not over-tighten the screw or the retract will bind and not operate correctly.



□ Step 14

Repeat Steps 11 through 13 to complete the retract installation.

Section 9: Engine Installation

Required Parts

- Fuselage
- Engine mount (2)
- 8-32 nylon lock nut (4)
- 8-32 blind nut (4)
- #8 washer (8)
- Engine
- 8-32 x 1 1/4" socket head screw (4)
- 8-32 x 1" socket head screw (4)

Required Tools and Adhesives

- Hex Wrench: 9/64"
- Ruler
- Adjustable wrench
- 11/32" socket wrench

Step 1

Locate the engine mount and the associated hardware.

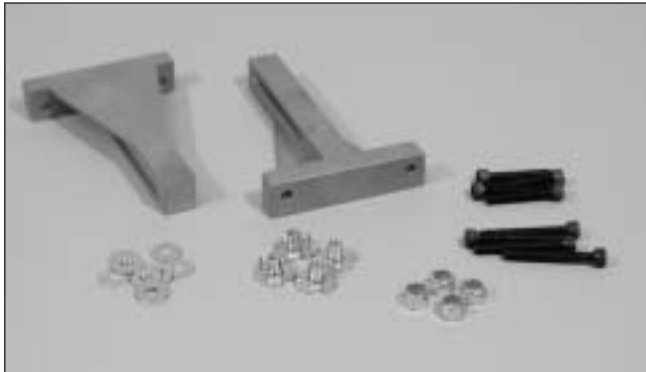

Step 2

Temporarily install the engine to the fuselage using four 8-32 x 1" socket head screws, four #8 washers and four blind nuts. Leave the bolts loose enough not to draw the blind nuts into the wood inside the fuselage.

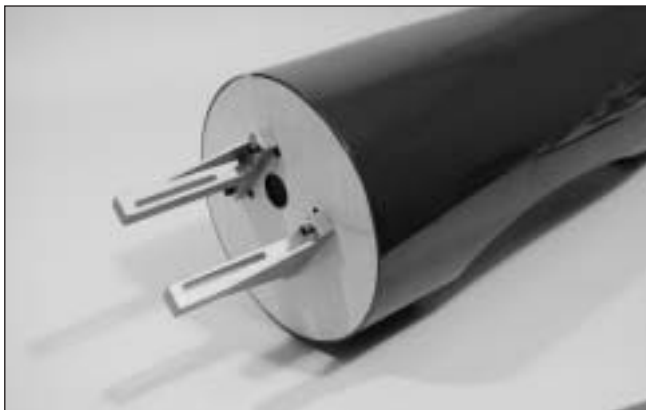

Hint: You can also install the blind nuts backwards to prevent them from pulling into the wood on the backside of the firewall. Just remember to move them to their correct positioning before moving to the next section.

Note: A pitts muffler will be required when installing a 2-stroke engine

Step 3

Position the engine on the mount and temporarily attach the engine using four 8-32 x 1 1/4" socket head screws, four #8 washers and four nylon lock nuts.

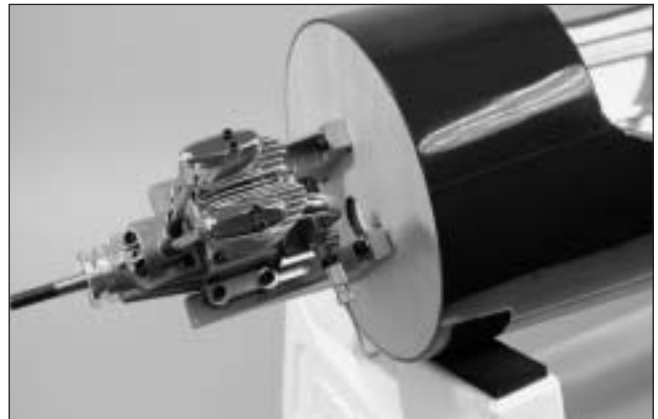

Step 4

Position the engine so the front of the drive washer is 5 5/8" from the firewall. Tighten the bolts holding the engine once the engine is positioned.

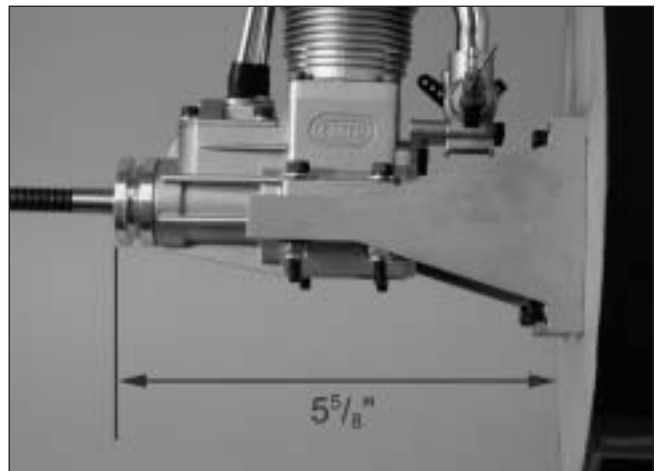

Section 9: Engine Installation

Step 5

Center the engine mount in relationship to the oval holes in the firewall. Tighten the bolts holding the mount to the firewall. (Remember to make sure the barbs on the blind nuts go into the backside of the firewall.)

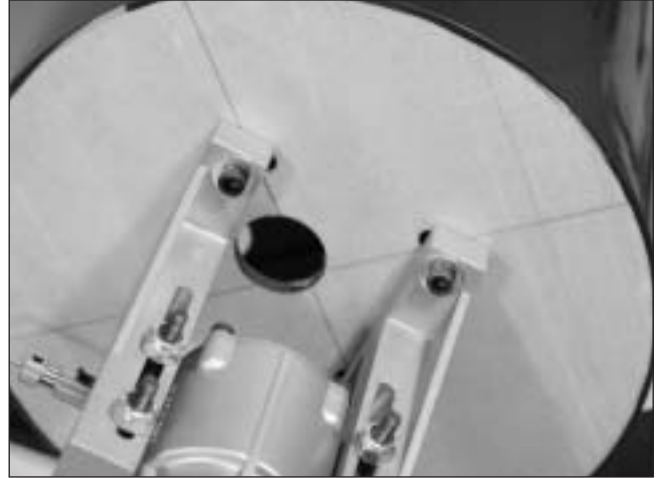

Section 10: Throttle Pushrod Installation

Required Parts

- 2-56 x 18" pushrod
- Plastic pushrod sleeve (12")

Required Tools and Adhesives

- Drill
- Drill Bit: 5/32"
- Felt-tipped pen
- Medium CA

Step 1

Determine the proper location for the throttle pushrod. Mark the location with a felt-tipped pen. Remove the engine and drill the firewall for the pushrod tube using a drill and 5/32" drill bit.

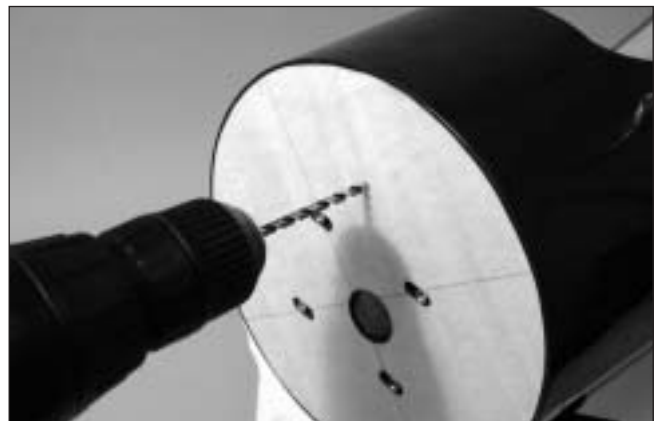

Section 10: Throttle Pushrod Installation

Step 2

Drill a 5/32" hole in former 2 that corresponds to the location of the hole drilled in the firewall.

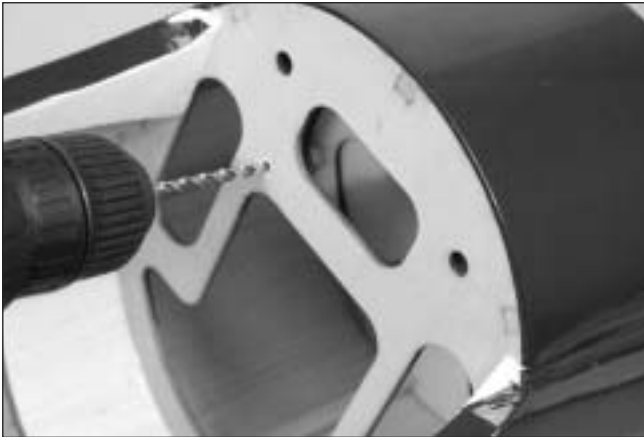

Step 3

Test fit the throttle pushrod tube through the firewall, through former 2, and into the fuselage. Once satisfied with the fit, roughen the tube using medium sandpaper. Slide the tube back into position and use medium CA to glue it to the firewall.

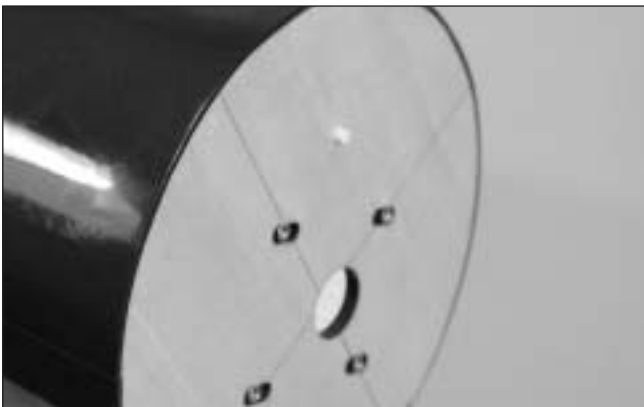

Step 4

Position the throttle servo tray so the opening for the servo is on the same side of the fuselage as the throttle pushrod tube. Use Medium CA to glue the tray into position.

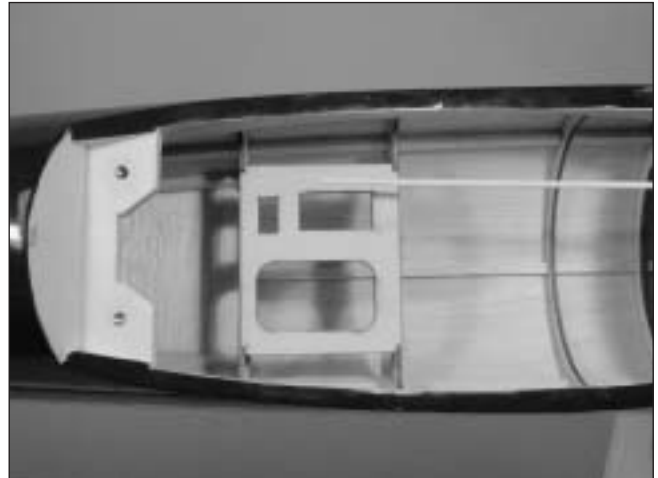

Step 5

Trim the throttle pushrod tube at the front of the servo opening.



Section 10: Throttle Pushrod Installation

Step 6

Attach the "Z" bend on the throttle pushrod wire onto the carburetor arm. Slide the pushrod wire into the tube and secure the engine to the firewall.

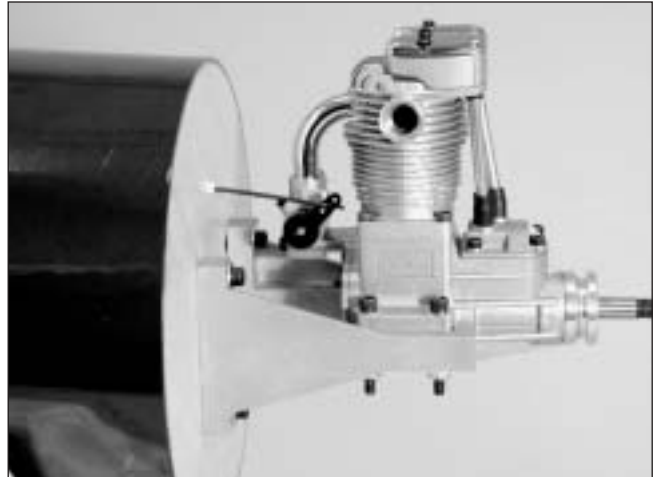
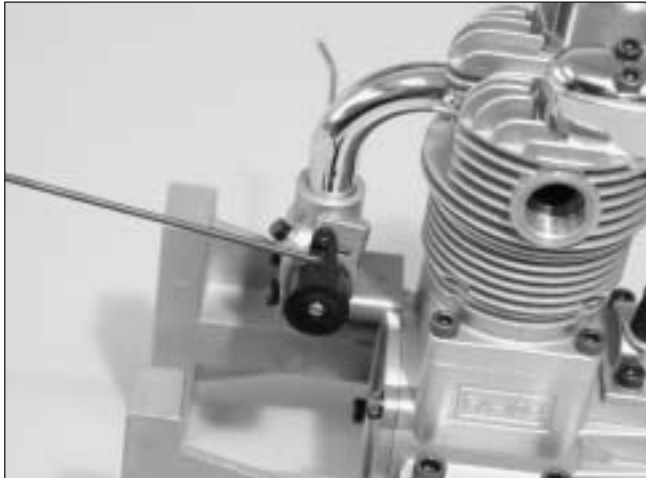

Section 11: Fuel Tank Assembly

Required Parts

- Clunk (fuel pickup)
- Fuel pickup tubing
- Rubber stopper
- Metal tubes (short and long)
- Metal caps (2)
- Fuel tank
- M3x20 screw

Required Tools and Adhesives

- Phillips screwdriver (small)
- Hobby knife

Note: The stopper provided with the Corsair has three holes that are not bored completely through the stopper. The holes are for the fuel pickup, fill, and vent lines. For these instructions only, two holes will be used: one for the fuel pickup and one for the fuel vent. Only open the third hole if you are going to use a separate fill line.

Step 1

Locate the fuel tank parts.

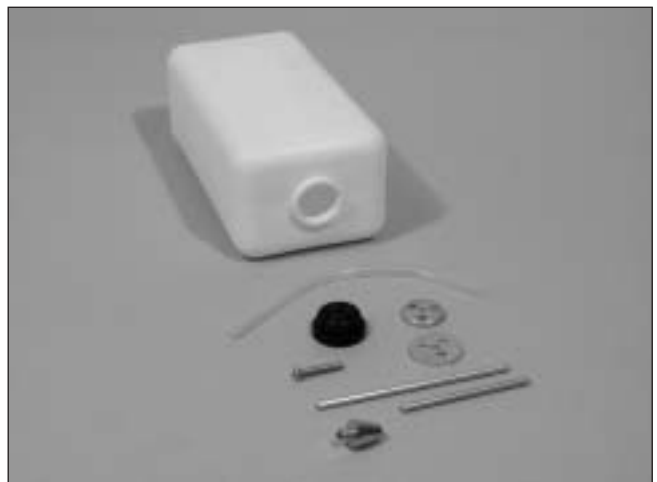

Section 11: Fuel Tank Assembly

Step 2

Locate the rubber stopper. Insert the shorter metal fuel tube into one of the holes in the stopper so that an equal amount of tube extends from each side of the stopper. This tube will be the fuel tank pickup that provides fuel to the engine.



Step 3

Slide the smaller cap over the tube on the smaller end of the rubber stopper. This end will be inserted into the fuel tank. The larger cap is placed on the side of the rubber stopper that makes the cap. Loosely install the M3 x 20 screw through the center of the stopper.



Step 4

Bend the longer fuel tube carefully to a 45-degree angle using your fingers. This will be the fuel tank vent tube. Use care not to kink the tube while bending.



Step 5

Slide the vent tube into one of the remaining two holes in the stopper from the tank (small cap) side.



Section 11: Fuel Tank Assembly

Step 6

Locate the short piece of silicone fuel tubing and the fuel tank clunk. Install the clunk onto one end of the silicone tubing. Slide the silicone tubing (end opposite the clunk) onto the fuel tank pickup tube (straight tube) in the stopper.

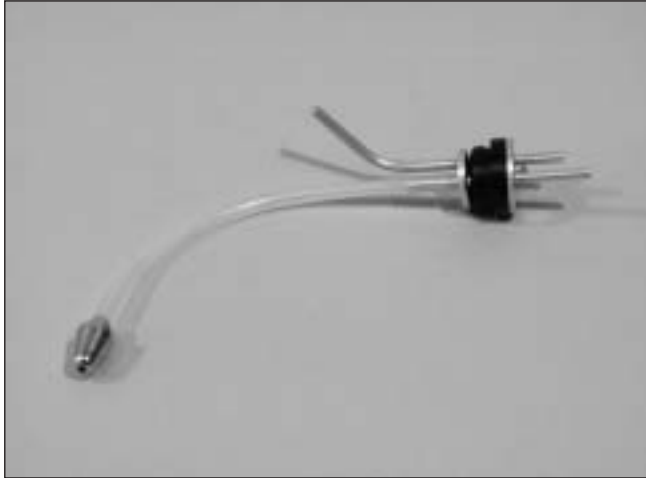

Step 7

Carefully insert the stopper assembly into the fuel tank. Note the position of the vent tube; it must be up at the top portion of the fuel tank to function properly. Also, it may be necessary to shorten the length of the fuel pickup tubing to make sure the clunk does not rub against the back of the fuel tank. You should be able to turn the tank to any attitude, and the clunk will fall to the lowest point. (All directions except for having the stopper facing down.)



Note: The fuel tank is taller than it is wide.

Step 8

Tighten the M3 x 20 screw carefully—do not over tighten. This allows the rubber stopper to form a seal by being slightly compressed, thus sealing the fuel tank opening.



Step 9

Mark the vent tube on the fuel tank. This will be helpful after the tank has been mounted in the fuselage.



Section 12: Fuel Tank Installation

Required Parts

- Fuselage assembly
- Fuel tank assembly
- Fuel tubing

Required Tools and Adhesives

- Foam: 1/4"
- Masking tape

When installing the fuel tank, make sure to have a piece of foam at any point that contacts any structure inside the fuselage. Without the foam, vibrations will be transmitted to the fuel tank, which could cause the fuel to foam. In turn, you will not get the optimum performance from your engine.

Step 1

Wrap the fuel tank in 1/4" foam as shown.



Step 2

Connect the two 8" pieces of fuel tubing to the fuel tanks pickup and vent tubes.



Step 3

Install the fuel tank into the fuselage. Make any necessary supports to keep the tank from moving during flight.

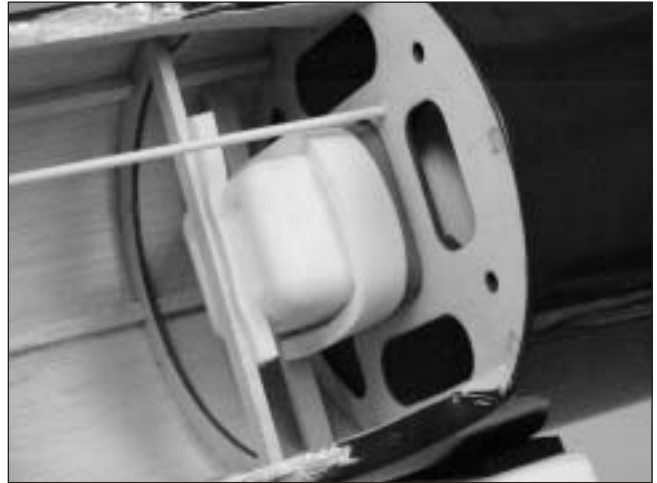

Note: Make sure that any support braces installed will not interfere with the installation of the wing or linkages.

Step 4

Install the muffler. There should be plenty of clearance between the muffler and firewall.

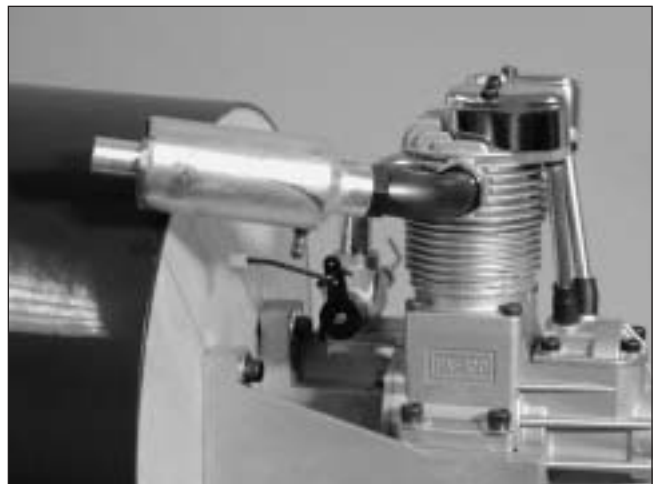

Section 12: Fuel Tank Installation

Step 5

Make the proper connections to the engine, using the engine manufacturer's instructions. If you are using a four-stroke, make sure to route the crankcase vent to the outside of the cowling.

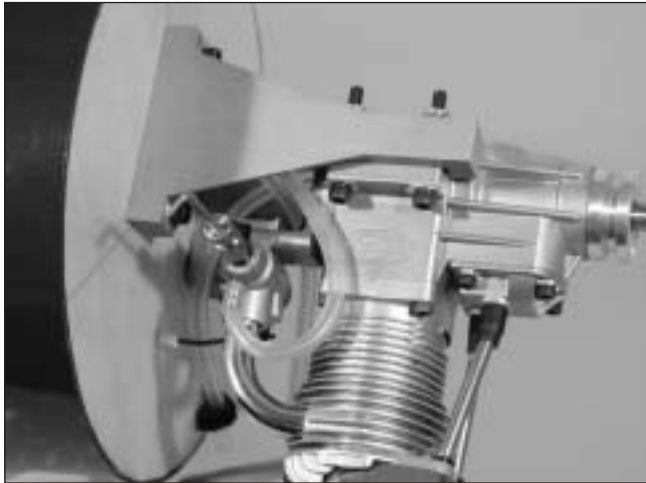

Section 13: Radio Installation

Required Parts

- Fuselage assembly
- Wing assembly
- Servo w/hardware (5)
- #2 x 3/8" screws (8)
- 3/8" x 5/8" x 5/8" servo mounting block (4)

Required Tools and Adhesives

- Drill
- Drill Bit: 1/16"
- 6-minute epoxy
- Thin CA
- Felt-tipped pen
- Hobby knife
- Phillips screwdriver (small)
- Ruler
- 9" Servo Extension (JRPA097) (2)
- 12" Servo Extension (JRPA098) (2)

Step 1

Install the recommended servo hardware (grommets and eyelets) supplied with your radio system onto five servos (elevator, rudder, throttle and 2 ailerons).

Step 2

Temporarily install the throttle servo. Mark the locations for the servo screws using a felt-tipped pen.

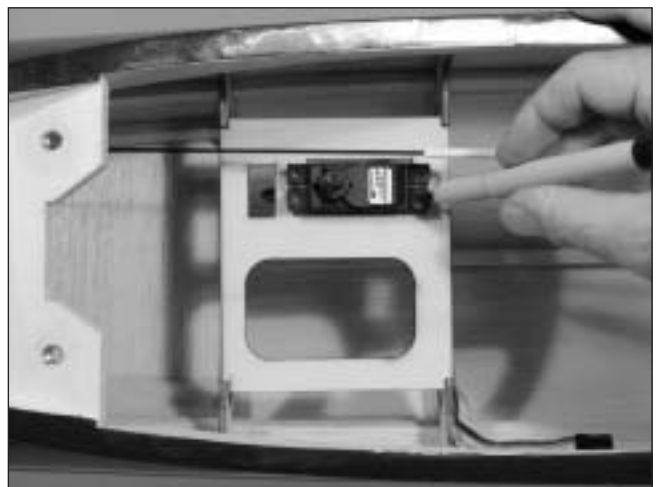

Section 13: Radio Installation

Step 3

Remove the servo and drill the holes for the servo mounting screws using a 1/16" drill bit.



Hint: Place a drop of thin CA onto each screw hole to harden the wood around the hole. Allow the CA to fully cure before installing the servos.

Step 4

Secure the throttle servo using the screws provided with the servo.

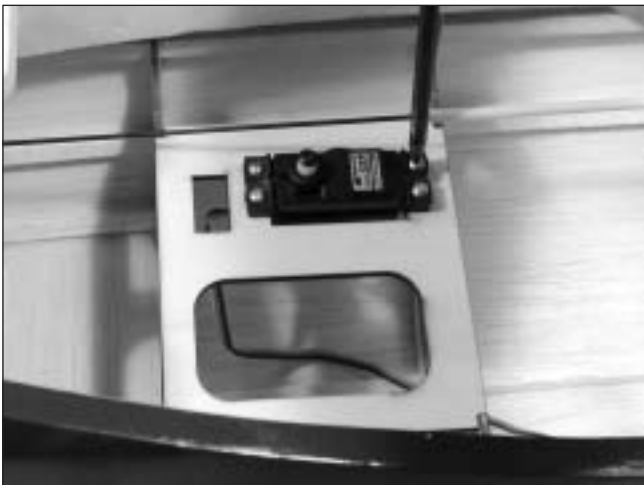

Step 5

Remove the covering from the opening on the bottom of the fuselage for the rudder servo.

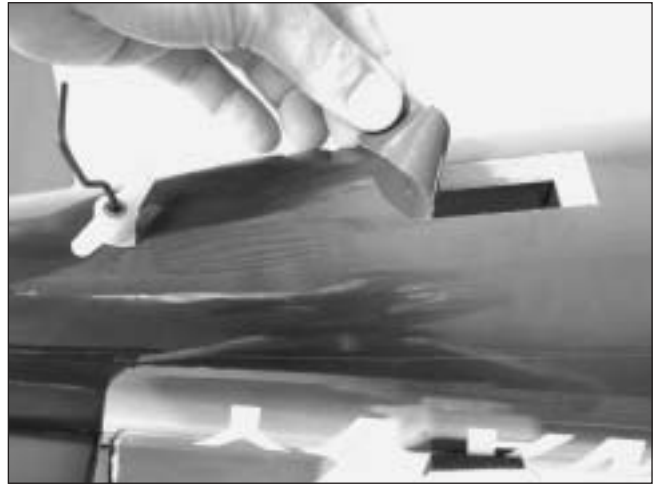

Step 6

Connect a 9" Servo Extension (JRPA097) to the servo lead. Secure the connectors by tying them in a knot using dental floss (as shown) or by using a commercially available connector clamp to prevent the servo leads from becoming disconnected.

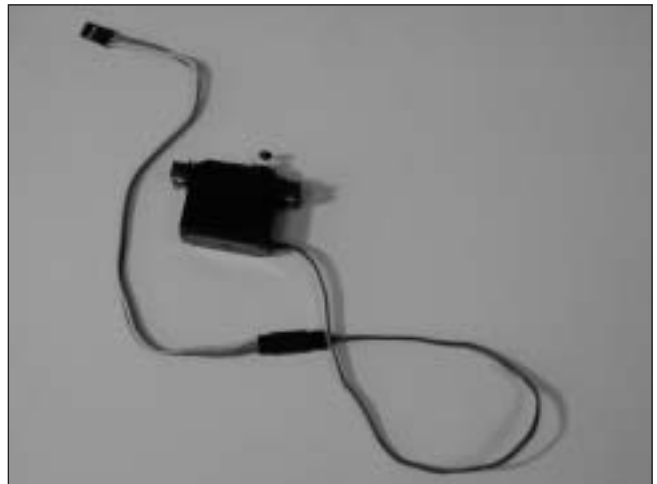

Note: It is always a good idea to secure the servo connector and servo extension together to prevent the wires from becoming unplugged.

Section 13: Radio Installation

Step 7

Temporarily install the rudder servo. Mark the locations for the servo screws using a felt-tipped pen. Remove the servo and drill the holes for the servo mounting screws using a 1/16" drill bit. Secure the rudder servo using the screws provided with the servo.



Step 8

Repeat Steps 5 through 7 for the elevator servo.



Step 9

Mount the radio switch to the side of the fuselage.



Step 10

Wrap the receiver and receiver battery in protective foam to prevent damage that may be caused by engine vibration.



Step 11

Connect any necessary extensions and Y-harnesses necessary to connect the retract and aileron servos. Connect the elevator, rudder and throttle servo leads to the receiver.

Section 13: Radio Installation

Step 12

Temporarily mount the receiver and battery into the fuselage. It may be necessary to relocate the battery forward or aft to balance the model as described in the section "Control Throws and Center of Gravity."



Step 13

Route the antenna through the bottom of the fuselage and secure it to a location at the tail with rubber bands.

Step 14

Remove the aileron hatch from the wing. Remove the covering from the slot for the aileron horn.

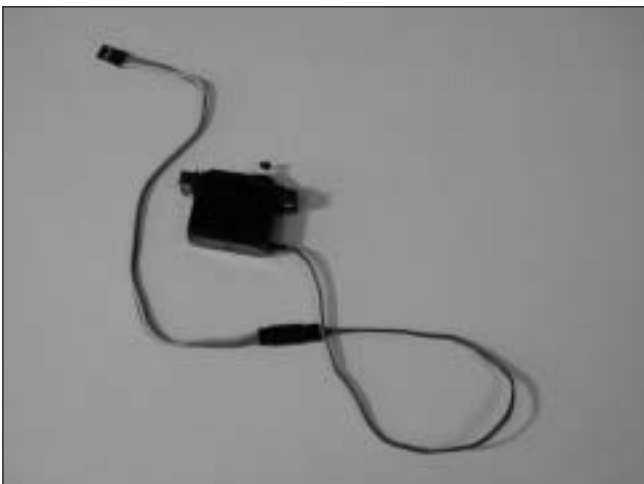

Note: The aileron servo is mounted directly to the hatch.

Step 15

Install the recommended servo hardware (grommets and eyelets) supplied with the servo. Temporarily install a long half servo arm (JRPA212) onto the servo and position the servo onto the hatch so the servo arm is centered in the notch. Once satisfied, mark the location for the servo mounting blocks.



Step 16

Locate the servo mounting blocks. Use 6-minute epoxy to glue the blocks to the hatch. Let the epoxy fully cure before proceeding to the next step.

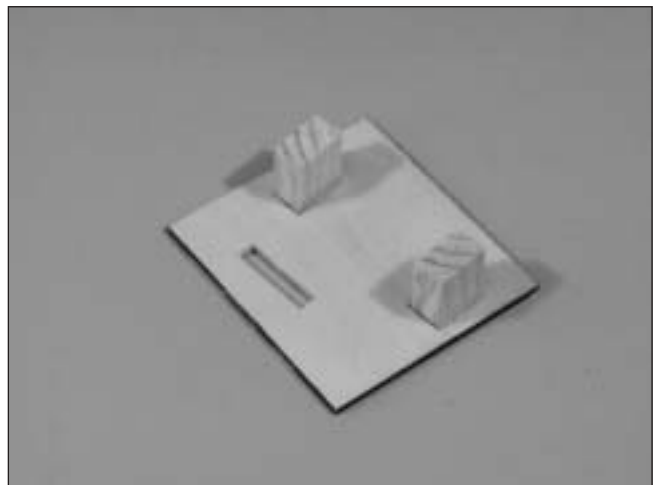

Section 13: Radio Installation

□ □ Step 17

Place the aileron servo between the mounting blocks and use a felt-tipped pen to mark the location of the four servo mounting screws. Note that the servo must not touch the hatch in order to isolate engine vibration.

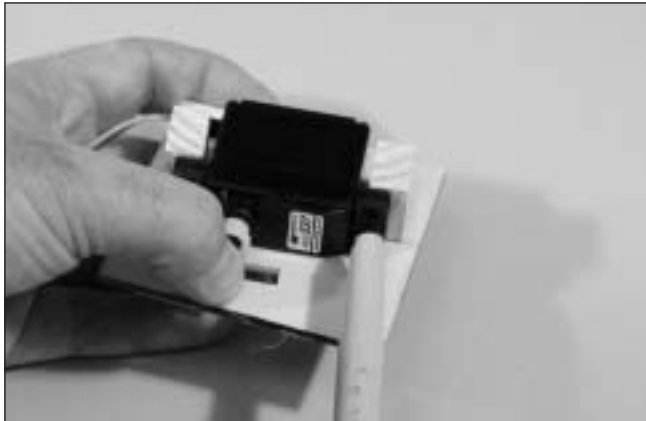

Note: Before mounting the servo, it is suggested to electronically center the servo using the transmitter, then install the servo arm to avoid having to remove the servo and center the arm later. It may be necessary to slightly trim one of the servo mounting blocks to clear the servo wire.

□ □ Step 18

Remove the servo and use a 1/16" drill bit to predrill the holes for the servo mounting screws marked in the previous step. Use the screws supplied with the servo to mount it to the servo mounting blocks.



□ □ Step 19

Connect a 12" Servo Lead extension (JRPA098) to the servo lead. Secure the connectors by tying them in a knot using dental floss (as shown) or by using a commercially available connector clamp to prevent the servo leads from becoming disconnected.

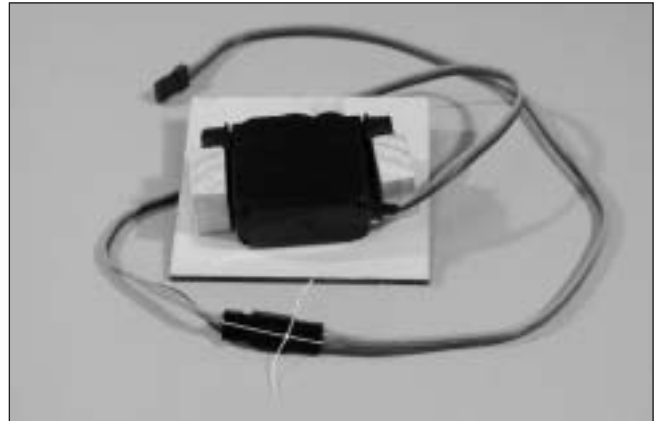

Note: It is always a good idea to secure the servo connector and servo extension together to prevent the wires from becoming unplugged.

□ □ Step 20

Tie the preinstalled string onto the servo extension. Gently pull the extension through the wing using the string. Untie the string when the servo lead has been pulled through. Use tape to secure the servo lead to the wing to prevent it from falling back into the wing panel.

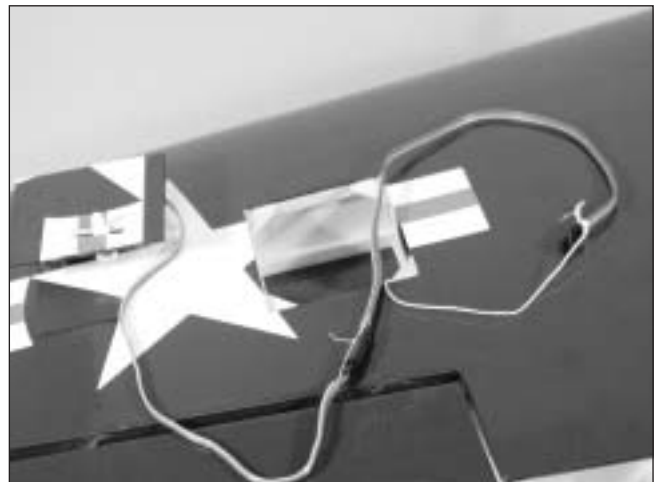

Section 13: Radio Installation

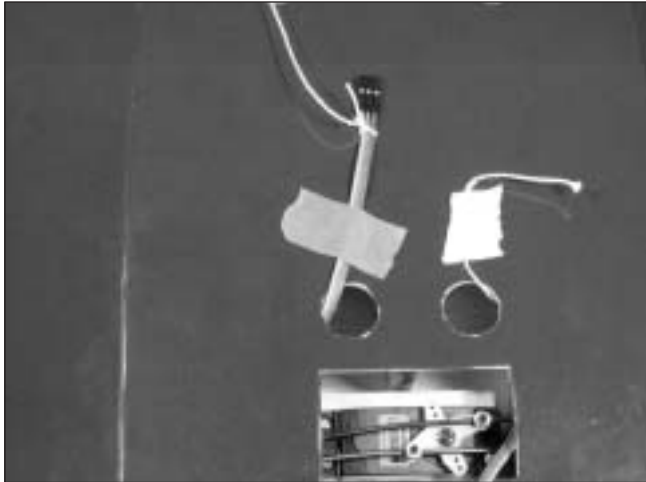

□ □ Step 21

Place the hatch cover in position in the aileron opening. Measure in 1/8" on all four sides of the hatch. Drill four 1/16" holes at the intersections of the lines as shown.

Note: Drill through the servo hatch and the underlying hatch mounts. Use caution not to accidentally drill through the top of the wing.

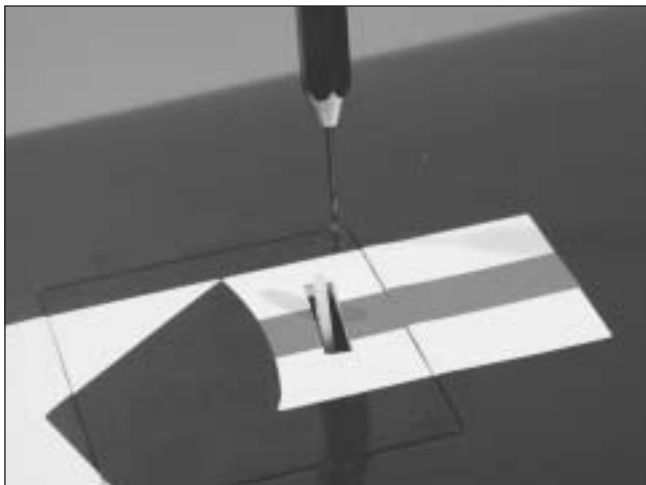

□ □ Step 22

Remove the servo hatch cover and re-drill the holes using a 5/64" drill bit. Use 2–3 drops of thin CA to harden the underlying wood. This will prevent the screws from crushing the wood when they are tightened. Secure the hatch using four #2 x 3/8" screws.

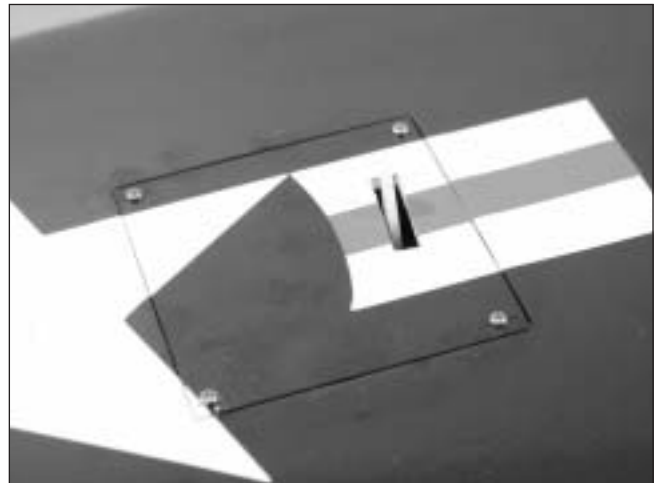
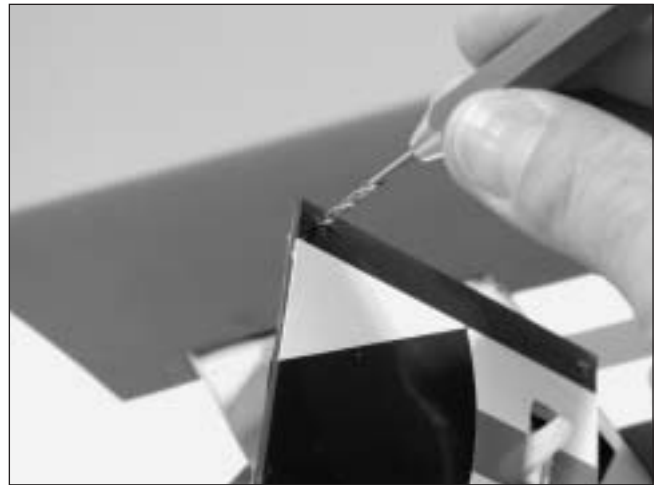

□ Step 23

Repeat Steps 14 through 22 for the remaining aileron servo.

Section 14: Linkage Installation

Required Parts

- Fuselage assembly
- Wing assembly
- 6" pushrod wire (3)
- 7" pushrod wire
- Nylon clevis (4)
- Nylon wire keeper (4)
- Nylon control horn (3)
- 2-56 x 3/4" screw (6)
- Quick connector
- M3x6 machine screw
- Quick connector backplate

Required Tools and Adhesives

- Drill
- Phillips screwdriver (small)
- Drill Bit: 1/16", 5/64", 3/32"

Step 1

Thread a clevis onto a 6" wire a minimum of 10 turns.

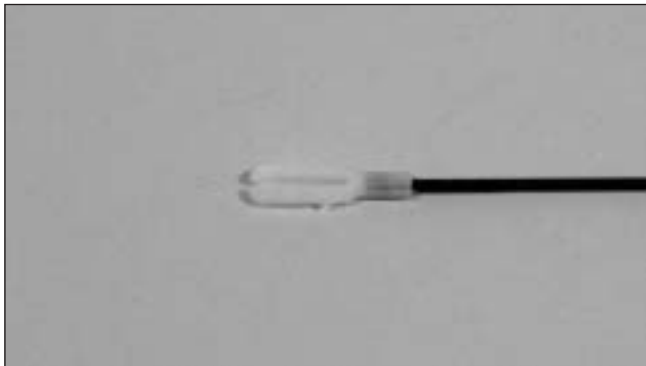

Step 2

Remove the back plate from a control horn using side cutters or a sharp hobby knife.



Step 3

Position the control horn on the elevator so the horn aligns with the hinge line of the elevator. Mark the position for the mounting holes using a felt-tipped pen.



Step 4

Drill three 3/32" holes through the elevator at the locations marked in the previous step.



Section 14: Linkage Installation

Step 5

Place 2–3 drops of thin CA into the hole to harden the wood. Repeat this for each of the three holes.



Step 6

Attach the control horn using three 2-56 x 1/2" screws and the control back plate.



Step 7

Center the elevator servo electronically using the radio system. Install a servo arm onto the elevator servo. Attach the pushrod with clevis to the control horn. Physically place the elevator control surface in neutral. Mark the pushrod where it crosses the holes in the servo arm.



Step 8

Bend the wire 90 degrees at the mark made in the previous step.



Section 14: Linkage Installation

Step 9

Cut the wire 3/8" above the bend.



Step 10

Slide the wire through the outer hole in the elevator servo arm. Secure the wire using a nylon wire keeper. It may be necessary to drill out the hole in the servo arm using a 5/64" drill bit.

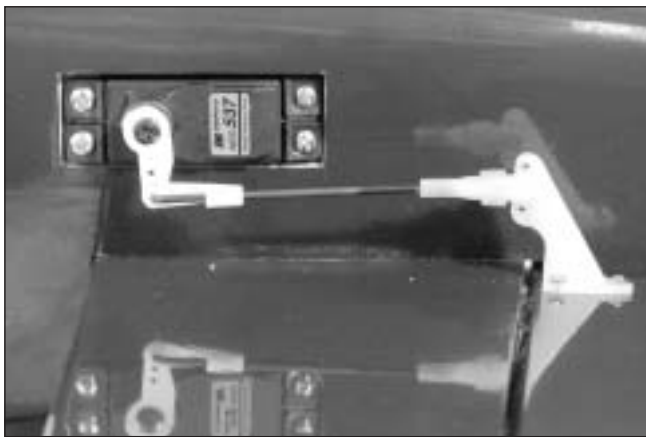

Note: Use a 1/4" piece of fuel tubing on the clevis to keep it from opening during flight.

Step 11

Thread a clevis onto a 7" wire a minimum of 10 turns.

Step 12

Center the rudder servo electronically using the radio system. Install a servo arm onto the rudder servo. Attach the pushrod with clevis to the steering control horn. Physically place the steering control horn parallel to the rudder servo arm. Mark the pushrod where it crosses the holes in the servo arm.

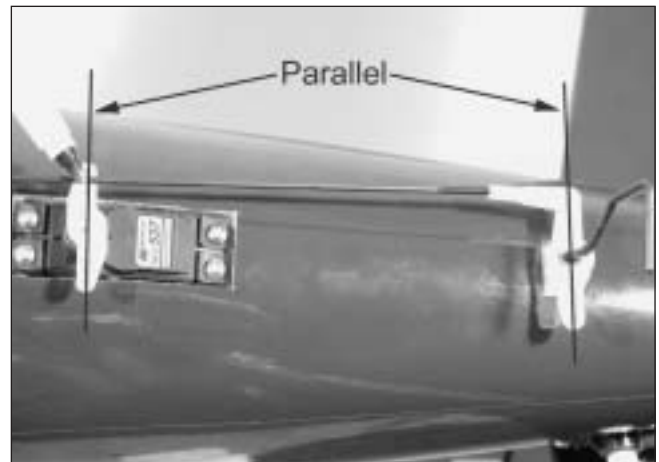

Step 13

Bend the wire 90 degrees at the mark made in the previous step. Cut the wire 3/8" above the bend.

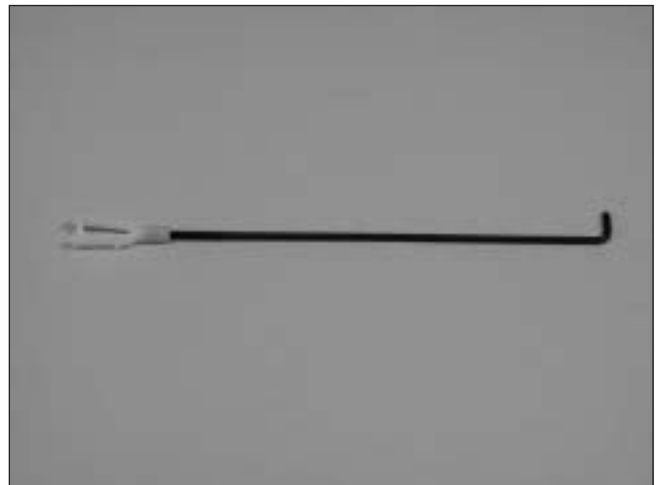

Section 14: Linkage Installation

Step 14

Slide the wire through the outer hole in the rudder servo arm. Secure the wire using a nylon wire keeper. It may be necessary to drill out the hole in the servo arm using a 5/64" drill bit.

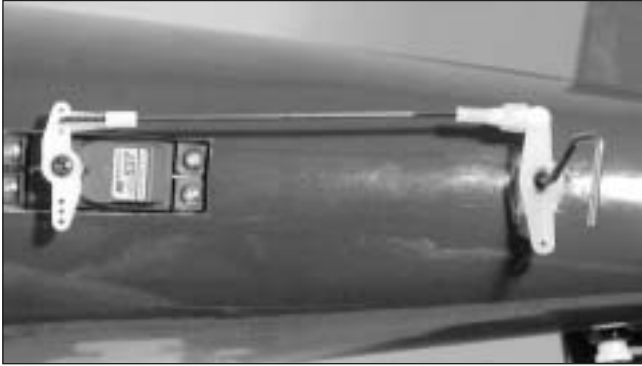

Note: Use a 1/4" piece of fuel tubing on the clevis to keep it from opening during flight.

Step 15

Position the rudder in neutral. Secure the steering control horn to the tail gear wire using a 3mm set screw.



Note: It is important to file a small flat spot on the tail gear wire and use threadlock on the set screw. Failure to do so may result in the set screw loosening during flight.

Step 16

Remove the back plate from a control horn using side cutters or a sharp hobby knife.

Step 17

Position the control horn on the aileron so the horn aligns with the aileron servo horn and the aileron hinge line. Mark the position for the mounting holes using a felt-tipped pen.

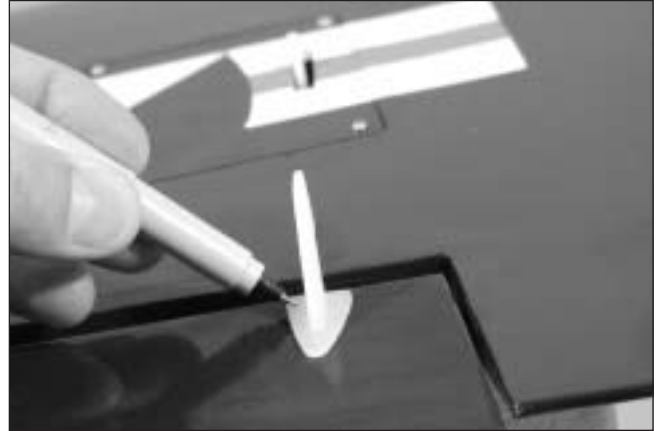

Step 18

Drill three 3/32" holes at the locations marked in the previous step.

Step 19

Attach the control horn using three #2 x 3/4" screws and the control horn backplate.



Section 14: Linkage Installation

Step 20

Slide a clevis retainer onto a nylon clevis. Thread a clevis onto a 6" wire a minimum of 10 turns.

Step 21

Center the aileron servo electronically using the radio system. Install a servo arm onto the aileron servo. Attach the pushrod with clevis to the control horn. Physically place the aileron control surface in neutral. Mark the pushrod where it crosses the holes in the servo arm.

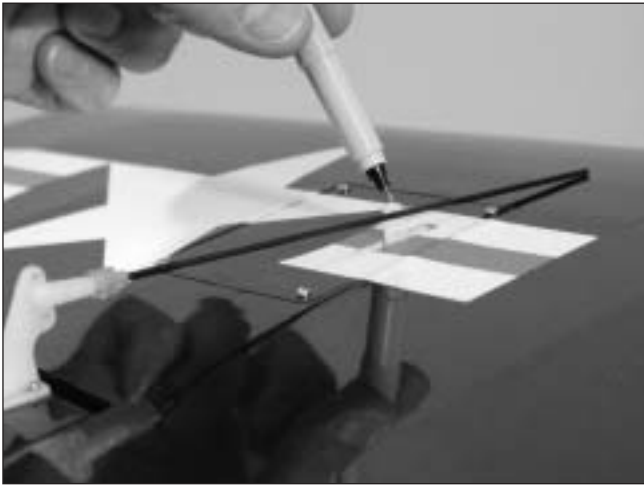

Step 22

Bend the wire 90 degrees at the mark made in the previous step. Cut the wire 3/8" above the bend.

Step 23

Slide the wire through the outer hole in the aileron servo arm. Secure the wire using a nylon wire keeper.



Step 24

Repeat Steps 16 through 23 for the other aileron servo.

Step 25

Use a 5/64" drill bit to drill a hole in the throttle servo arm.



Step 26

Attach a quick connector to the servo arm using quick connector washers and retainers.



Section 14: Linkage Installation

Step 27

Center the throttle stick and trim with both the receiver and transmitter on. Install the throttle servo arm in the neutral position.

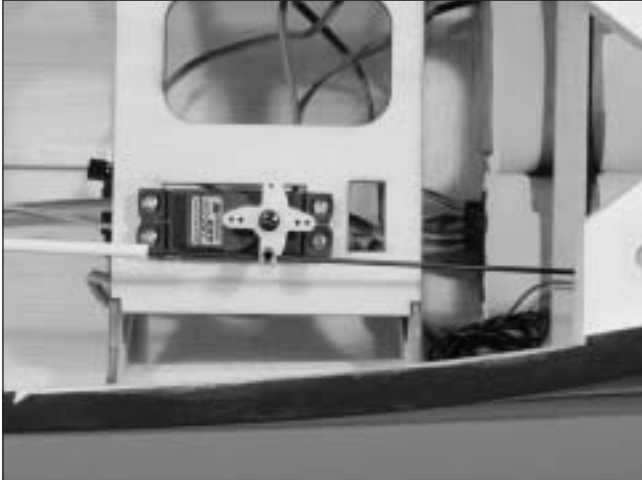

Step 28

Move the servo to the throttle closed position using the radio system. Manually move the throttle arm on the carburetor to the closed position. Use a 3mm set screw to secure the throttle pushrod wire.

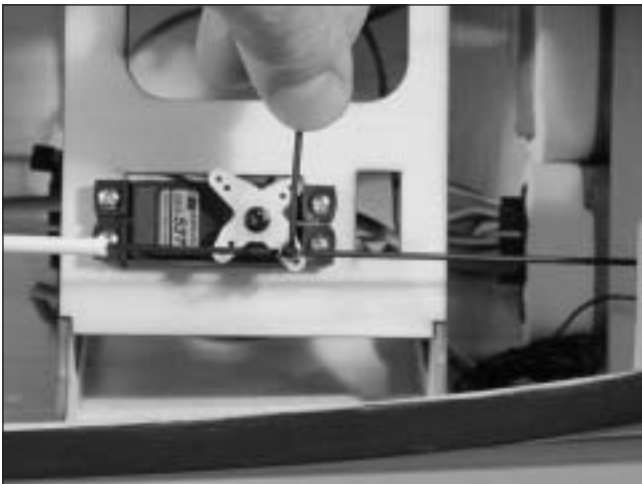

Step 29

Check the movement of the throttle to verify there is no binding at either low or high throttle. If there is, make the necessary adjustment to eliminate any binding. Install the throttle servo arm screw when complete.

Step 30

Use scrap wood to make a brace for the throttle pushrod tube near the servo as shown.

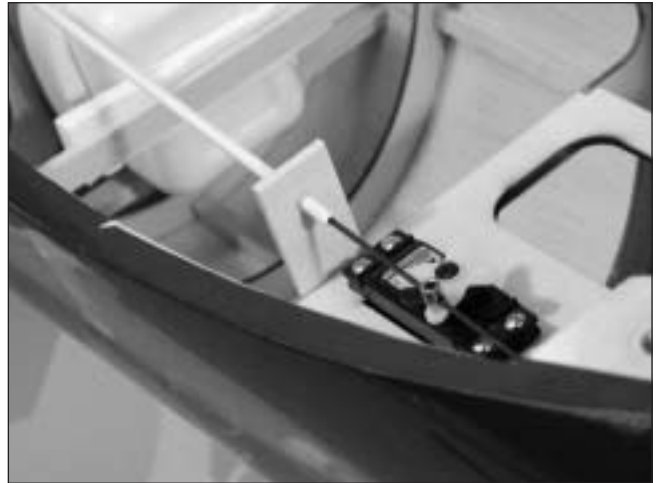

Step 31

Install the tail wheel using a 3/32" wheel collar and 3mm set screw.



Section 15: Cowling Installation

Required Parts

- Fuselage assembly
- Cowling
- #2 x 1/2" sheet metal screw (4)
- 5/8" x 3/4" x 3/4" cowl mounting block (4)
- Dummy radial engine

Required Tools and Adhesives

- Drill
- Drill Bit: 1/16", 1/8"
- Hobby scissors
- 6-minute epoxy
- Phillips screwdriver (small)
- Rotary tool with sanding drum

Step 1

Locate the dummy radial engine. Use a sharp hobby knife to trim the material between the cylinders as shown. Leave the material above the cylinders in tact for strength. Remove the center area for the engine drive washer.



Hint: The dummy radial engine can also be painted at this time. Just remember to test the paint on the pieces removed to make sure the paint won't attack the plastic.

Step 2

Use 6-minute epoxy to glue the dummy radial inside the cowl.



Step 3

Locate the four cowl mounting blocks. Sand the same radius as the fuselage onto one side of each block.

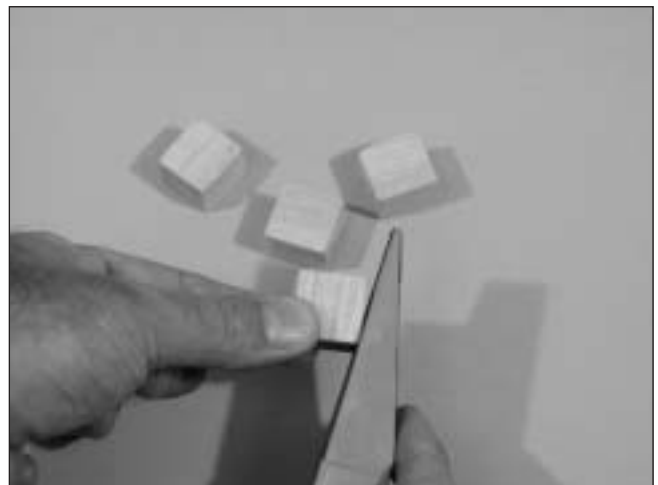

Section 15: Cowling Installation

Step 4

Sand four areas onto the firewall that are 45 degrees from the centerlines. The areas must be large enough to fit the cowl mounting blocks.



Step 5

Position the cowl mounting blocks so the rounded edge of the block extends 1/4" from the outside edge of the fuselage. Glue the cowl mounting blocks to the firewall using 6-minute epoxy.

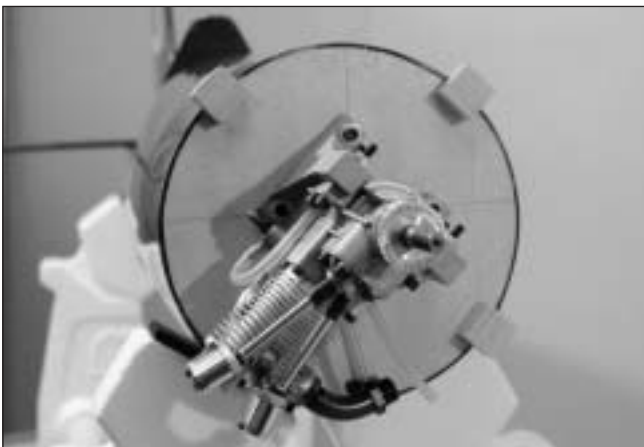
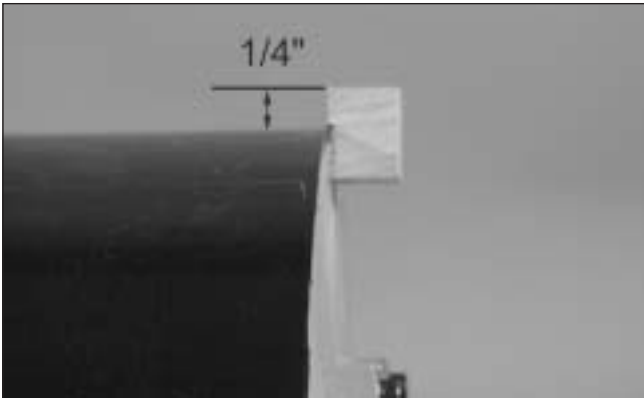

Step 6

Use a piece of cardstock to indicate the location of the engine head, needle valve and cowl mounting blocks.

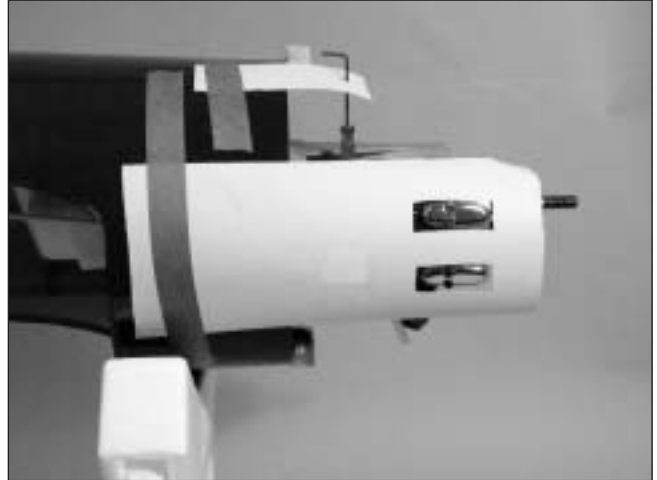

Hint: Remove the muffler at this time and fit the cowl to it later.

Step 7

Remove the engine. Position the cowl onto the fuselage so it is 5 1/2" from the firewall. Transfer the location for the engine and needle valve onto the cowl.



Section 15: Cowling Installation

Step 8

Remove the cowl and remove the necessary material to fit the cowl over the engine. Install the engine back onto the firewall and test fit the cowl over the engine. Use a small amount of threadlock on the four bolts to prevent them from loosening during flight.

Hint: Start by removing only a little material at a time. Work until the cowl fits nicely over the engine.

Step 9

Slide the cowling onto the fuselage. Position the cowl so the engine drive washer is 1/8" in front of the dummy engine.



Step 10

Use the cardstock from Step 1 to locate the positions for the cowling screws. The goal is to drill into the cowl mounting blocks for the four screws that hold the cowling. Drill the locations using a 1/16" drill bit.

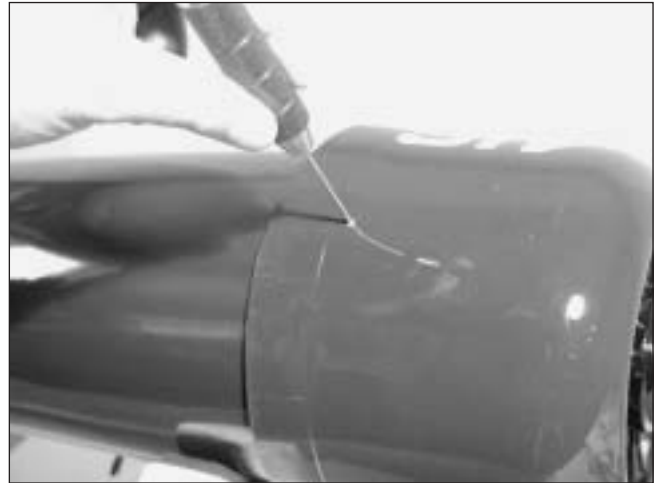

Step 11

Enlarge the holes drilled in the cowling using a 1/8" drill bit.

Step 12

Attach the cowl using four #2 x 1/2" sheet metal screws.



Hint: Apply a couple drops of CA into the screw holes after threading the screws in a couple times. This will harden the wood and keep the screws from loosening during flight.

Section 16: Canopy and Decal Installation

Required Parts

- Fuselage assembly
- Canopy
- #2 x 1/2" sheet metal screw (2)

Required Tools and Adhesives

- Canopy glue (RC-56)
- Zap-A-Dap-A-Goo
- Sandpaper (medium grit)

Step 1

Install a pilot of your choosing. Use epoxy or Zap-A-Dap-A-Goo to secure the pilot.

Step 2

Use Lexan® scissors to trim the backrest. Use Zap-A-Dap-A-Goo to glue the backrest into position.



Step 3

Use Lexan scissors to trim the canopy.



Step 2

Position the canopy onto the fuselage. Trace around the canopy and onto the fuselage using a felt-tipped pen.



Step 3

Lightly sand the inside edge of the canopy and slightly inside the line drawn on the hatch using medium sandpaper.



Section 16: Canopy and Decal Installation

Step 4

Apply a bead of RCZ56 Canopy Glue (ZINJ5007) around the inside edge of the canopy. Position the canopy onto the hatch. Use tape to hold the canopy secure until the glue fully cures.

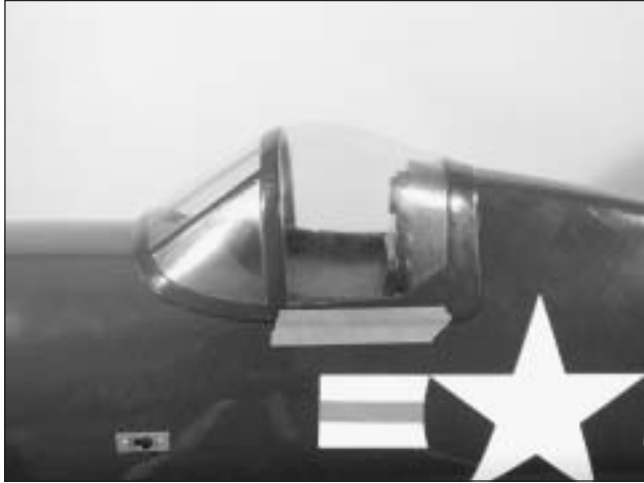

Step 5

Apply the decals. Use the photos on the box to aid in their location.

Step 6

Use Lexan[®] scissors to trim the radiators. Use Zap-A-Dap-A-Goo to glue the radiators into position on the wing.



Adjusting the Engine

Step 1

Completely read the instructions included with your engine and follow the recommended break-in procedure.

Step 2

At the field, adjust the engine to a slightly rich setting at full throttle and adjust the idle and low-speed needle so that a consistent idle is achieved.

Step 3

Before you fly, be sure that your engine idles reliably, transitions and runs at all throttle settings. Only when this is achieved should any plane be considered ready for flight.

Control Throws and Center of Gravity

Recommended CG Location

An important part of preparing the aircraft for flight is properly balancing the model. This is especially important when various engines are mounted.

Caution: Do not inadvertently skip this step!

The recommended Center of Gravity (CG) location for the Corsair is 5" behind the leading edge of the wing against the fuselage. Make sure the gear is retracted when checking the CG, as the CG will change depending on the gear position. If necessary, move the battery pack or add weight to either the nose or the tail until the correct balance is achieved. Stick-on weights are available at your local hobby shop and work well for this purpose.

The amount of control throw should be adjusted as closely as possible using mechanical means, rather than making large changes electronically at the radio. By moving the position of the clevis at the control horn toward the outermost hole, you will decrease the amount of control throw of the control surface.

Moving it toward the control surface will increase the amount of throw. Moving the pushrod wire at the servo arm will have the opposite effect: Moving it closer to center will decrease throw, and away from center will increase throw. Work with a combination of the two to achieve the closest or exact control throws listed.

Recommended Control Throws

	Low Rate	High Rate
Aileron	1/2" (11°) up 1/2" (11°) down	9/16" (16°) up 11/16" (15°) down
Elevator	9/16" (11°) up 9/16" (11°) down	7/8" (17°) up 13/16" (16°) down
Rudder	1 1/2" (20°) left 1 1/2" (20°) right	2" (27°) left 2" (27°) right

Note: Control throws are measured at the widest part of the elevator, rudder, and aileron unless otherwise noted .

Preflight at the Field

Charge both the transmitter and receiver pack for your airplane. Use the recommended charger supplied with your particular radio system, following the instructions provided with the radio. In most cases the radio should be charged the night before going out flying.

Check the radio installation and make sure all the control surfaces are moving correctly (i.e. the correct direction and with the recommended throws). Test run the engine and make sure it transitions smoothly

from idle to full throttle and back. Also ensure the engine is tuned according to the manufacturers instructions, and it will run consistently and constantly at full throttle when adjusted.

Check all the control horns, servo horns and clevises to make sure they are secure and in good condition. Replace any items that would be considered questionable. Failure of any of these components in flight would mean the loss of your aircraft.

Range Testing the Radio

Before each flying session, range-check your radio. This is accomplished by turning on your transmitter with the antenna collapsed. Turn on the radio in your airplane. With your airplane on the ground, you

should be able to walk 30 paces away from your airplane and still have complete control of all functions. If not, don't attempt to fly! Have your radio equipment checked out by the manufacturer.

2003 Official AMA National Model Aircraft Safety Code

Effective January 1, 2003

Model Flying **MUST** be in accordance with this Code in order for AMA Liability Protection to apply.

GENERAL

1) I will not fly my model aircraft in sanctioned events, air shows or model flying demonstrations until it has been proven to be airworthy by having been previously, successfully flight tested.

2) I will not fly my model higher than approximately 400 feet within 3 miles of an airport without notifying the airport operator. I will give right-of-way and avoid flying in the proximity of full-scale aircraft. Where necessary, an observer shall be utilized to supervise flying to avoid having models fly in the proximity of full-scale aircraft.

3) Where established, I will abide by the safety rules for the flying site I use, and I will not willfully and deliberately fly my models in a careless, reckless and/or dangerous manner.

4) The maximum takeoff weight of a model is 55 pounds, except models flown under Experimental Aircraft rules.

5) I will not fly my model unless it is identified with my name and address or AMA number, on or in the model. (This does not apply to models while being flown indoors.)

6) I will not operate models with metal-bladed propellers or with gaseous boosts, in which gases other than air enter their internal combustion engine(s); nor will I operate models with extremely hazardous fuels such as those containing tetranitromethane or hydrazine.

7) I will not operate models with pyrotechnics (any device that explodes, burns, or propels a projectile of any kind) including, but not limited to, rockets, explosive bombs dropped from models, smoke bombs, all explosive gases (such as hydrogen filled balloons), ground mounted devices launching a projectile. The only exceptions permitted are rockets flown in accordance with the National Model Rocketry Safety Code or those permanently attached (as per JATO use); also those items authorized for Air Show Team use as defined by AST Advisory Committee (document available from AMA HQ). In any case, models using rocket motors as a primary means of propulsion are limited to a maximum weight of 3.3 pounds and a G series motor. (A model aircraft is defined as an aircraft with or without engine, not able to carry a human being.)

8) I will not consume alcoholic beverages prior to, nor during, participation in any model operations.

9) Children under 6 years old are only allowed on the flight line as a pilot or while under flight instruction.

RADIO CONTROL

1) I will have completed a successful radio equipment ground range check before the first flight of a new or repaired model.

2) I will not fly my model aircraft in the presence of spectators until I become a qualified flier, unless assisted by an experienced helper.

3) At all flying sites a straight or curved line(s) must be established in front of which all flying takes place with the other side for spectators. Only personnel involved with flying the aircraft are allowed at or in the front of the flight line. Intentional flying behind the flight line is prohibited.

2003 Official AMA National Model Aircraft Safety Code

Continued

4) I will operate my model using only radio control frequencies currently allowed by the Federal Communications Commission. (Only properly licensed Amateurs are authorized to operate equipment on Amateur Band frequencies.)

5) Flying sites separated by three miles or more are considered safe from site-to site interference, even when both sites use the same frequencies. Any circumstances under three miles separation require a frequency management arrangement which may be either an allocation of specific frequencies for each site or testing to determine that freedom from interference exists. Allocation plans or interference test reports shall be signed by the parties involved and provided to AMA Headquarters. Documents of agreement and reports may exist between (1) two or more AMA Chartered Clubs, (2) AMA clubs and individual AMA members not associated with AMA Clubs, or (3) two or more individual AMA members.

6) For Combat, distance between combat engagement line and spectator line will be 500 feet per cubic inch of engine displacement. (Example: .40 engine = 200 feet.); electric motors will be based on equivalent combustion engine size. Additional safety requirements will be per the RC Combat section of the current Competition Regulations.

7) At air shows or model flying demonstrations a single straight line must be established, one side of which is for flying, with the other side for spectators.

8) With the exception of events flown under AMA Competition rules, after launch, except for pilots or helpers being used, no powered model may be flown closer than 25 feet to any person.

9) Under no circumstances may a pilot or other person touch a powered model in flight.

Organized RC Racing Event

10) An RC racing event, whether or not an AMA Rule Book event, is one in which model aircraft compete in flight over a prescribed course with the objective of finishing the course faster to determine the winner.

A. In every organized racing event in which contestants, callers and officials are on the course:

1. All officials, callers and contestants must properly wear helmets, which are OSHA, DOT, ANSI, SNELL or NOCSAE approved or comparable standard while on the racecourse.

2. All officials will be off the course except for the starter and their assistant.

3. "On the course" is defined to mean any area beyond the pilot/staging area where actual flying takes place.

B. I will not fly my model aircraft in any organized racing event which does not comply with paragraph A above or which allows models over 20 pounds unless that competition event is AMA sanctioned.

C. Distance from the pylon to the nearest spectator (line) will be in accordance with the current Competition Regulations under the RC Pylon Racing section for the specific event pending two or three pylon course layout.

11) RC Night flying is limited to low performance models (less than 100 mph). The models must be equipped with a lighting system that clearly defines the aircraft's attitude at all times.



© 2003, Horizon Hobby, Inc.
4105 Fieldstone Road
Champaign, Illinois 61822
(877) 504-0233
www.horizonhobby.com