

•Class and type : Iowa-class battleship •Displacement : 45,000 tons •Length : 887.2 ft (270.4 m) •Beam : 108.2 ft (33.0 m) •Draft : 28.9 ft (8.8 m)

•Speed : 32.7 kn (37.6 mph; 60.6 km/h) •Range : 14,890 mi (23,960 km) •Complement : 2,700 officers and men

•Armament

9 × 16 in (406 mm)/50 cal Mark 7 guns, 20 × 5 in (127 mm)/38 cal Mark 12 guns, 80 × 40 mm/56 cal anti-aircraft guns, 49 × 20 mm/70 cal anti-aircraft cannons

•Armor : Belt: 12.1 in (310 mm), Bulkheads: 11.3 in (290 mm), Barbettes: 11.6 to 17.3 in (290 to 440 mm), Turrets: 19.7 in (500 mm), Decks: 7.5 in (190 mm)

•일반 특성

배수량: 45,000 t 기본 / 58,000 t 만재 길이: 887 ft 3 in (270.43 m) 선폭: 108 ft 2 in (32.98 m) 높이: 38 ft (11.6 m) 속도: 33 knots (61 km/h) 승무원: 1,851

•무장

1943년 9문 Mk.7 16인치 50구경 함포, 20문 Mk.12 5인치 38구경 함포, 80문 보포스 40mm 대공포

•장갑

벨트: 12.1 in (310 mm), 격벽: 11.3 in (290 mm), 포탑기둥: 11.6 to 17.3 in (290 to 440 mm), 포탑: 19.7 in (500 mm), 갑판: 7.5 in (190 mm)

•화력통제

4 × Mk 37 사격통제시스템, 2 × Mk 38 Gun Director, 1 × Mk 40 Gun Director

주문일자: 1940년 6월 12일 용공설치: 1941년 1월 6일 진수식: 1944년 1월 29일 실전배치: 1944년 6월 11일 최종퇴역: 1992년 3월 31일

●● This is a multicolored kit, which can be a precise reproduction of reality not having to paint.

●● 본 제품은 도색 없이도 실물과 가깝게 재현할 수 있는 멀티 컬러 키트입니다.

14222/14222A

▶ parts location diagram/ 부품도

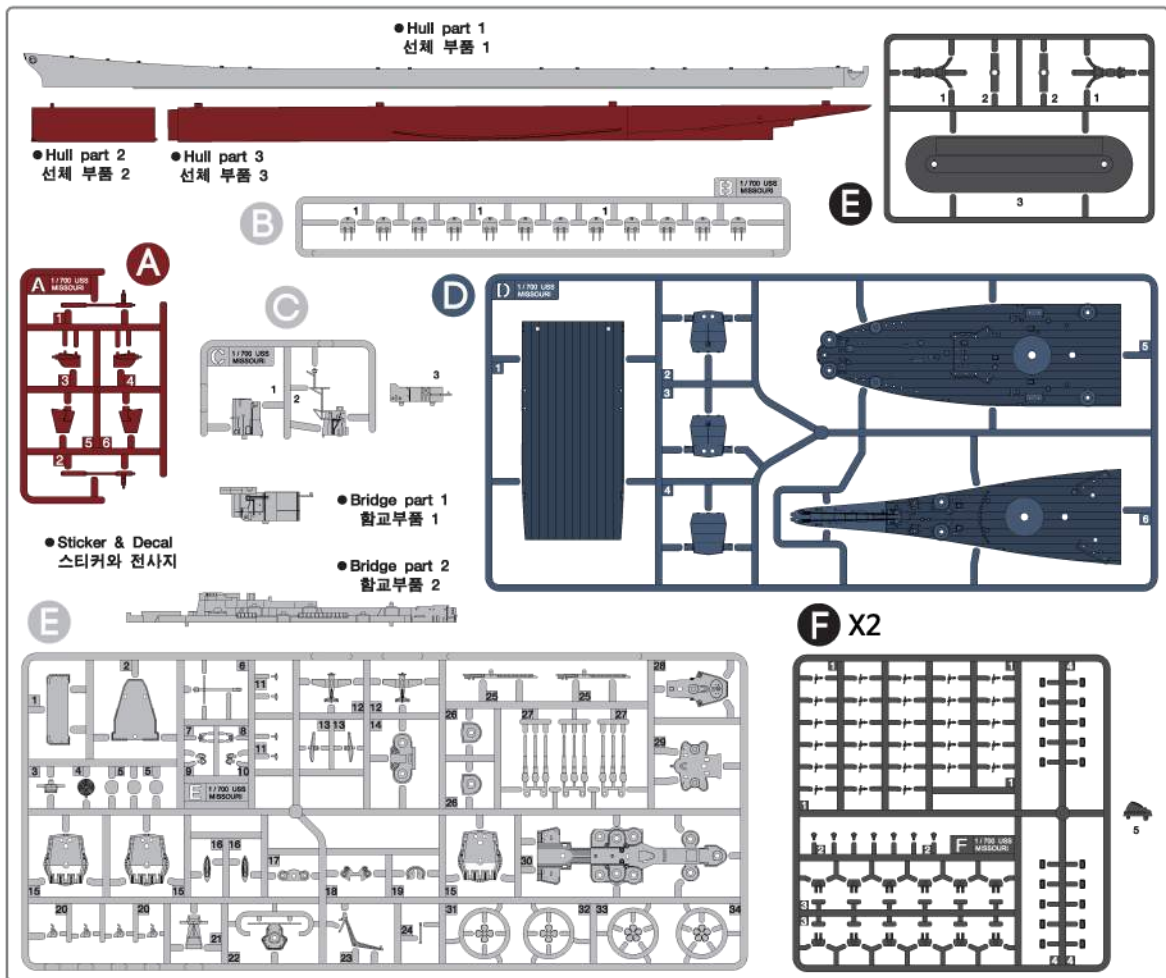

MANUAL 1

14222/14222A 1/700th USS Missouri BB-63



Hull part 3
선체 부품 3

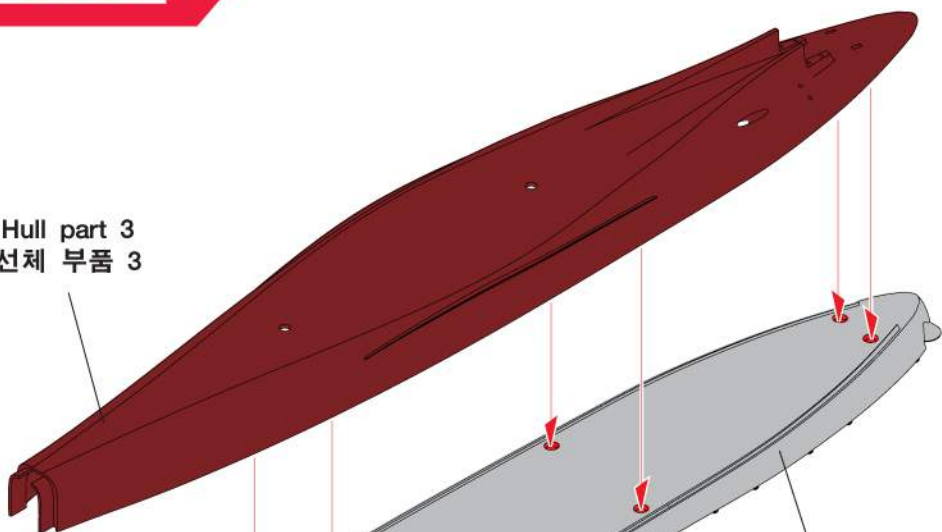

Hull part 1
선체 부품 1



Hull part 2
선체 부품 2

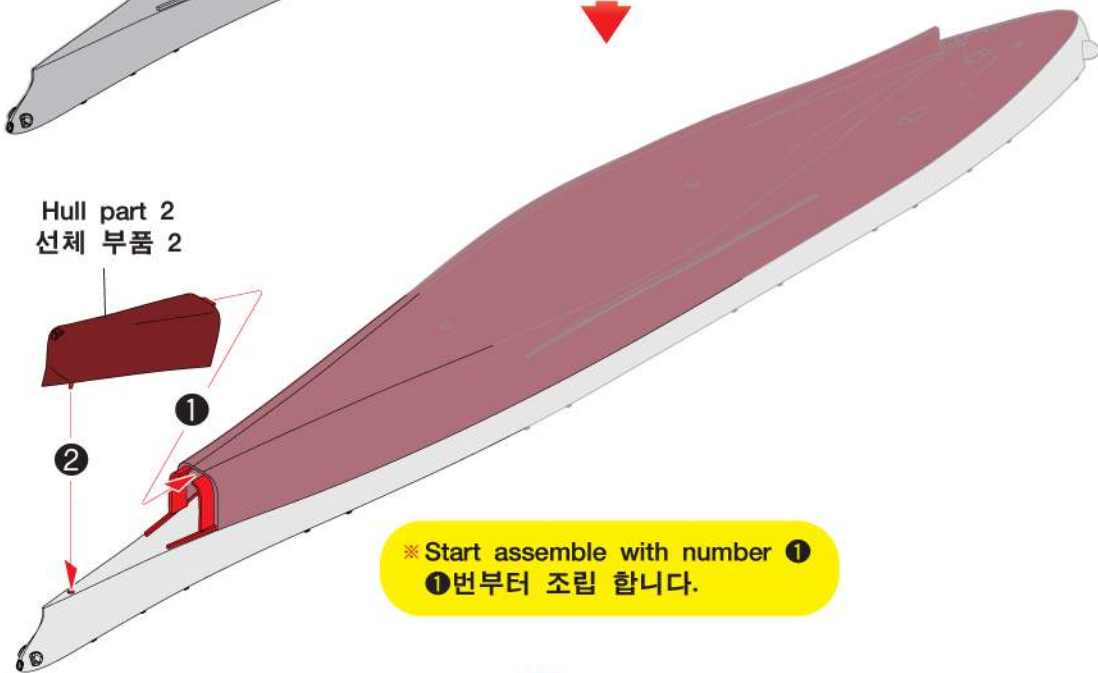

※ Start assemble with number ①
①번부터 조립 합니다.

2

※ Start assemble with number 1
①번부터 조립 합니다.

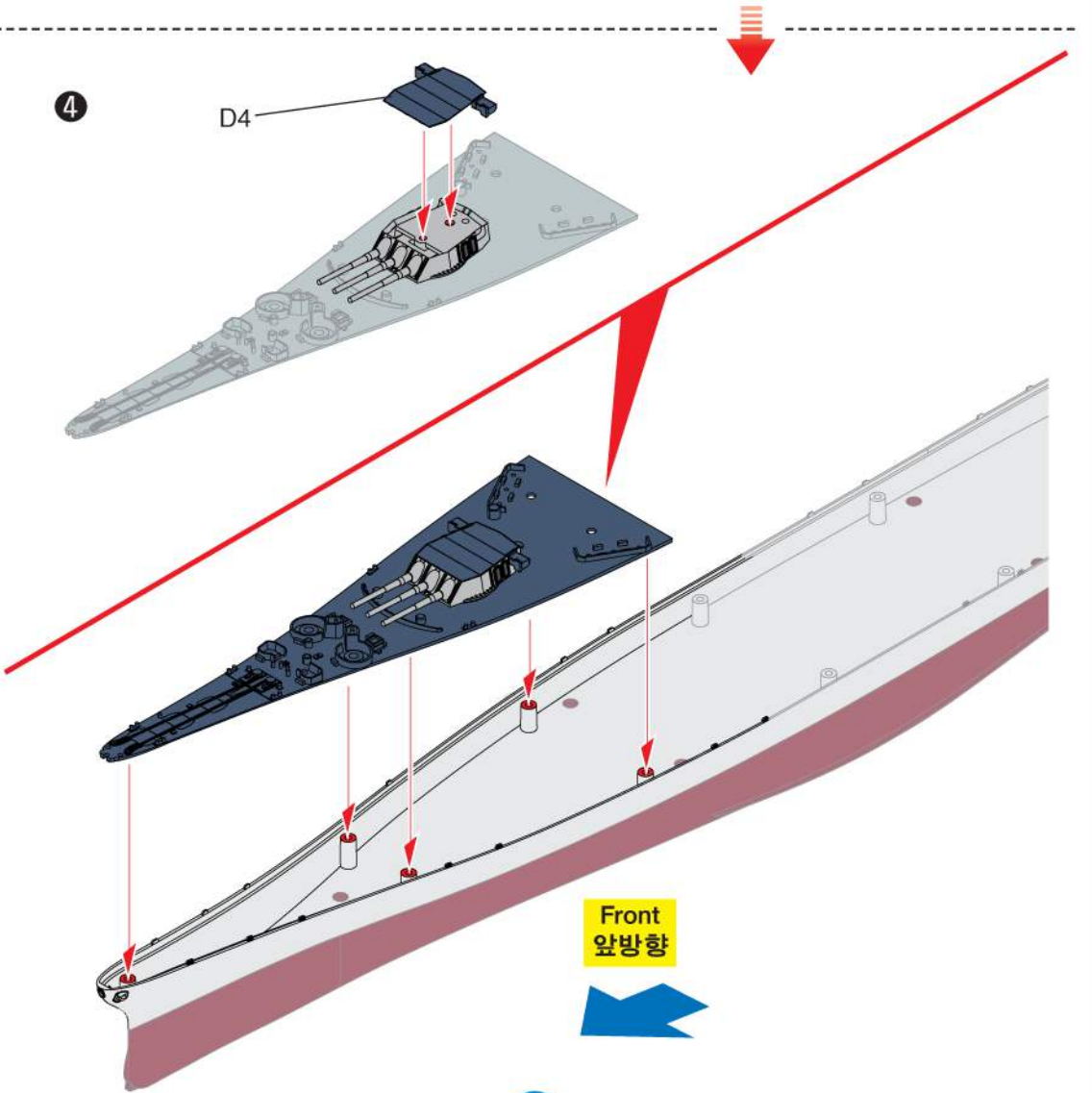
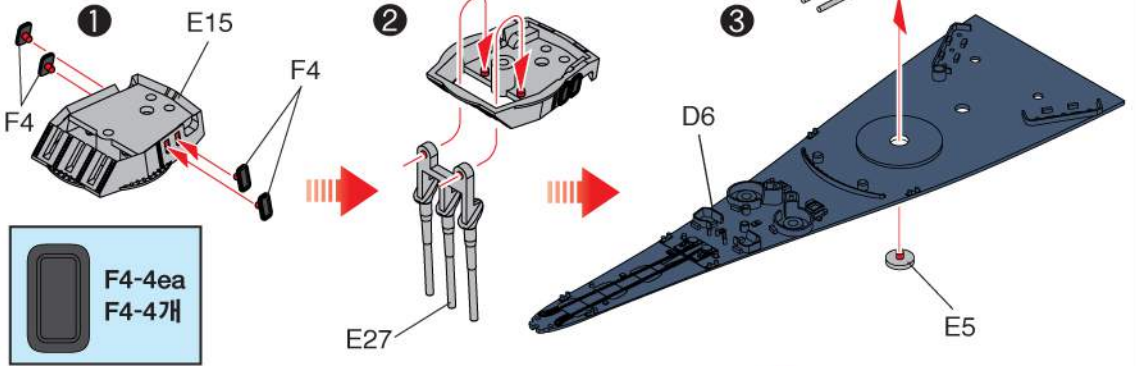

3

3

※ Start assemble with number ①
①번부터 조립 합니다.

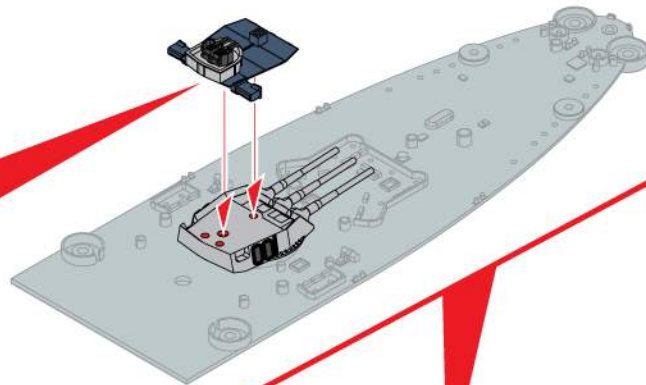
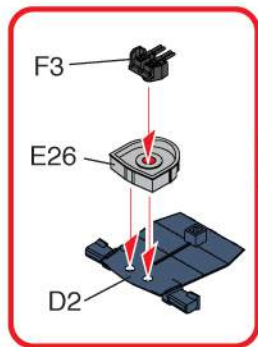
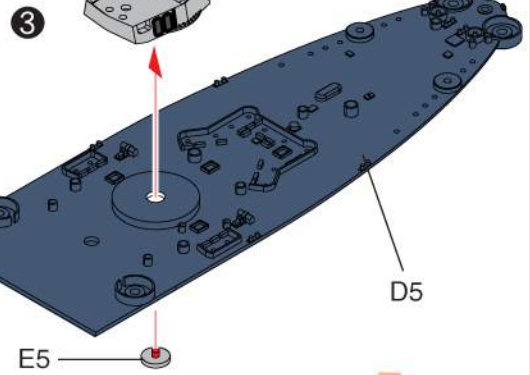
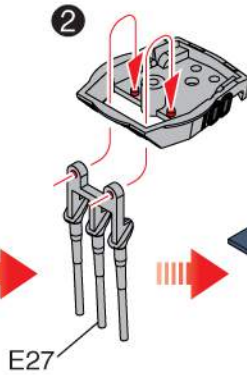
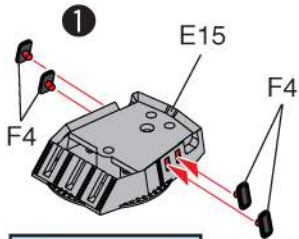

④

Front
앞방향

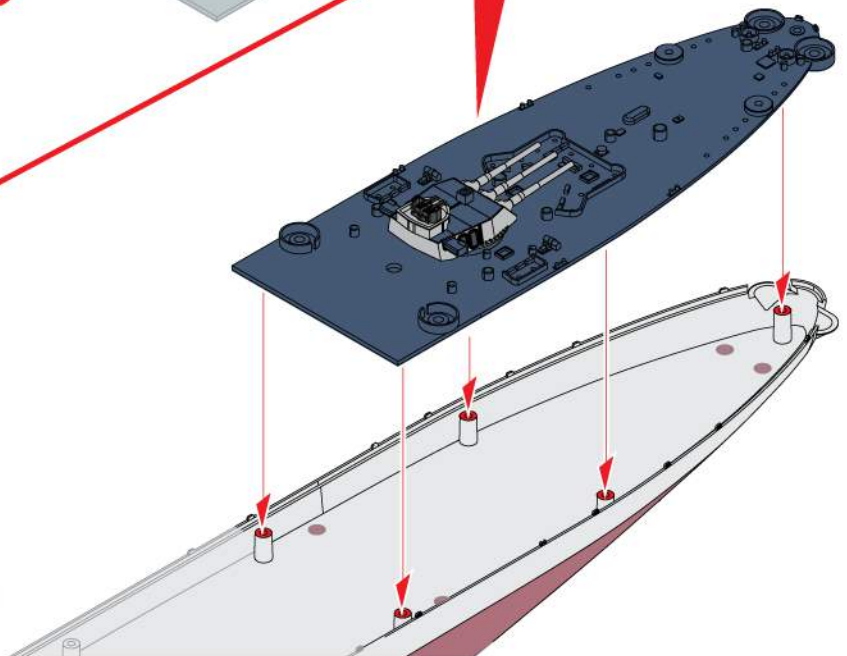

4

4

Rear view

후면



※ Note the direction!
방향에 주의 하세요!

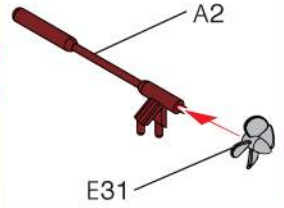
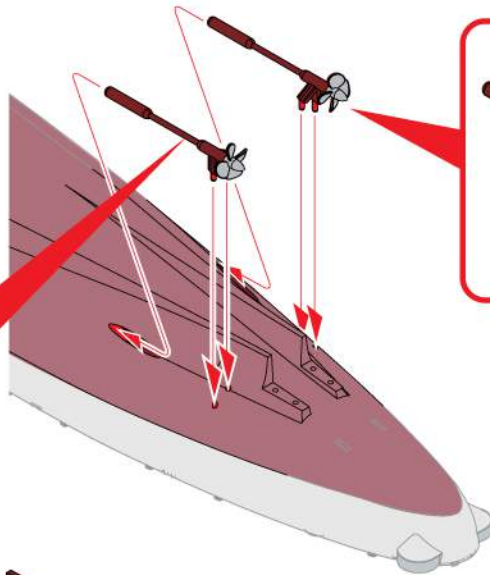
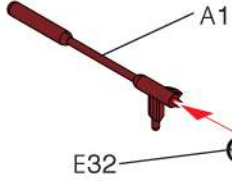

Rear view

후면



※ Note the direction!
방향에 주의 하세요!

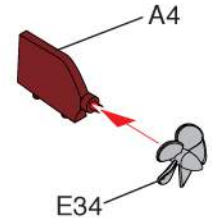
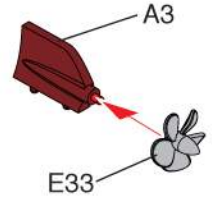
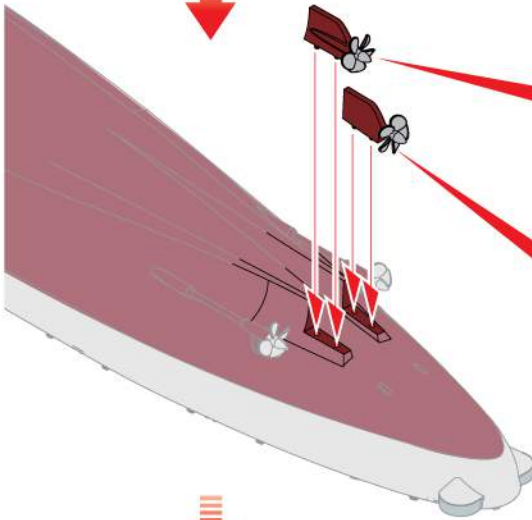

Front
앞방향

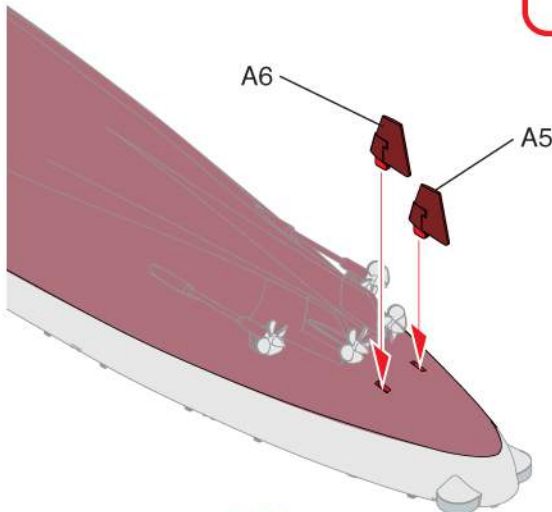

Side view
옆면

Front
앞방향



※ Note the direction!
방향에 주의 하세요!

5

5

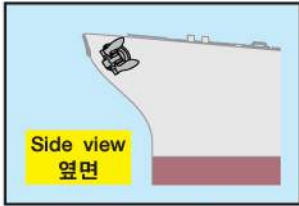

※ Note the direction!
방향에 주의 하세요!

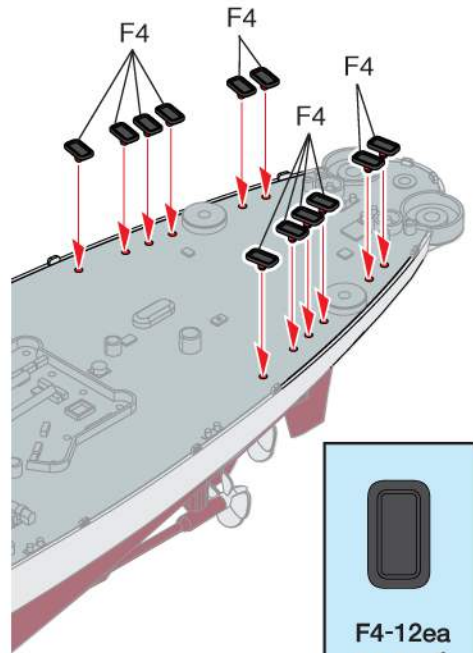
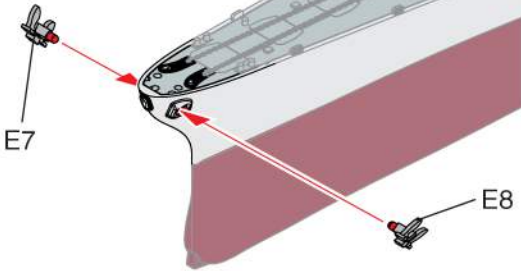

6

※ Cement use
접착제를 사용하세요.

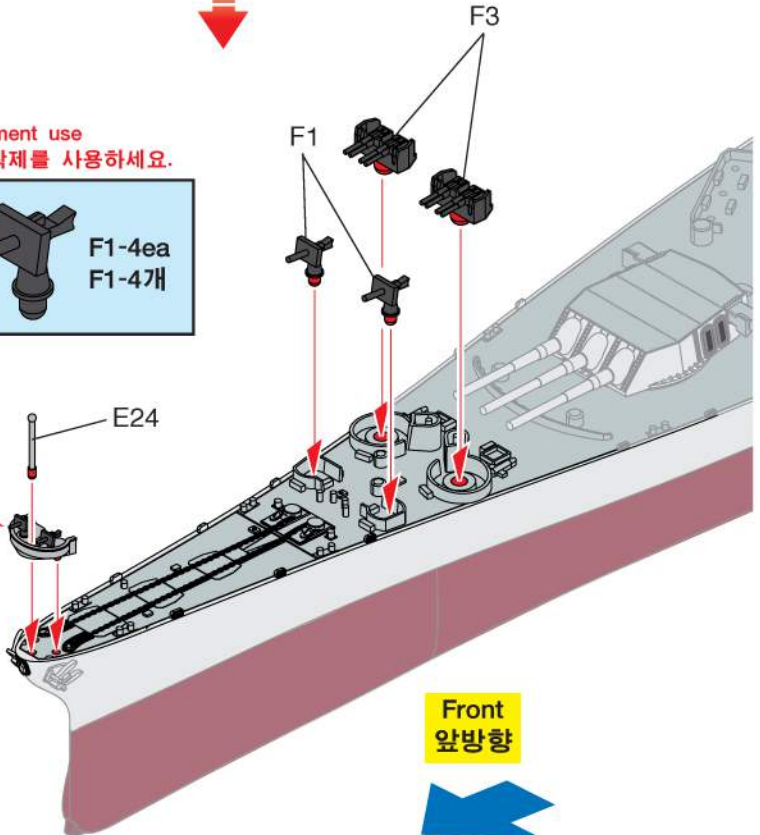
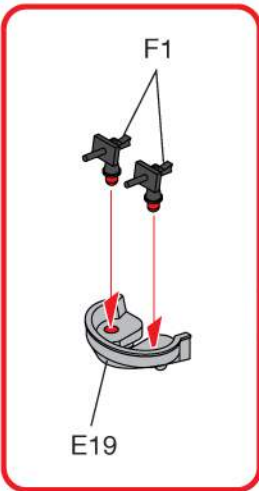
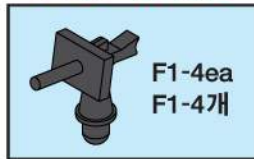

7

※ Cement use
접착제를 사용하세요.

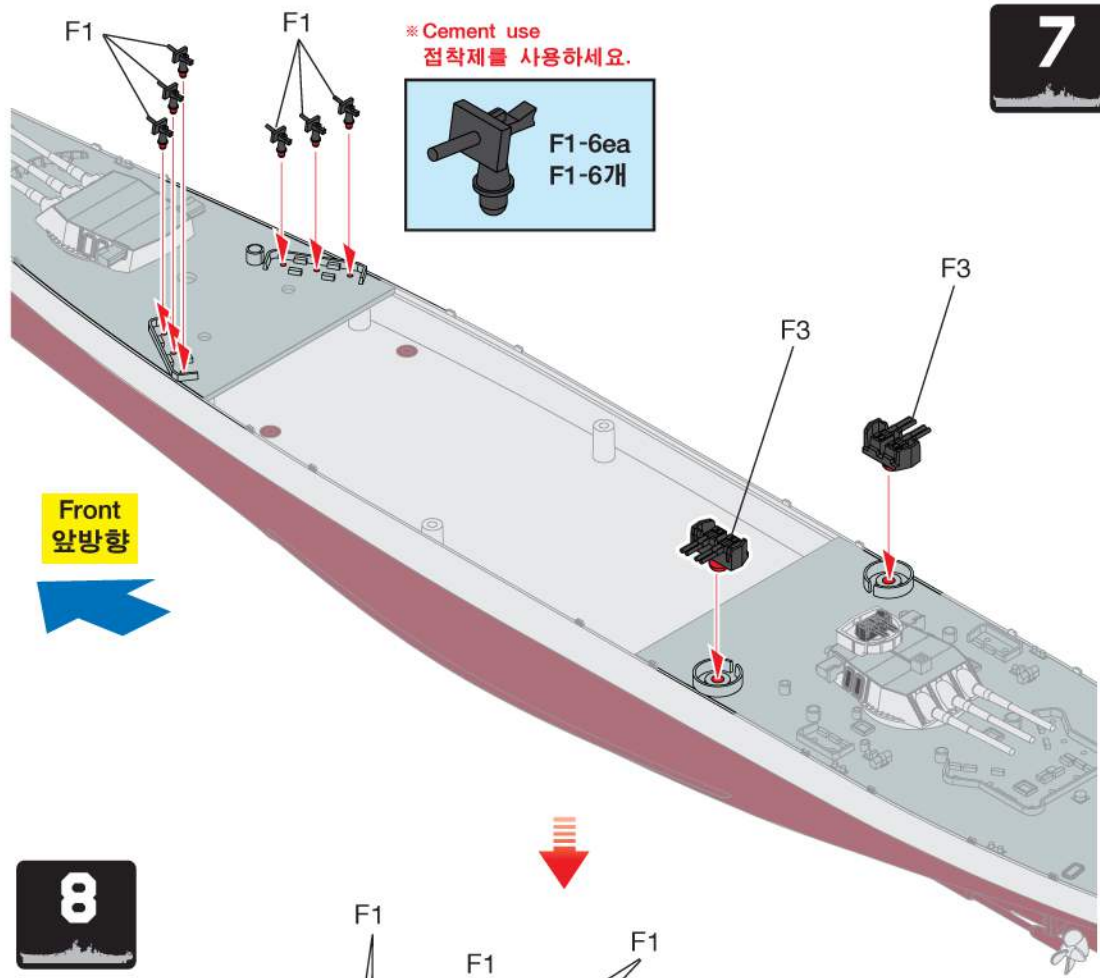
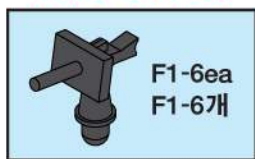

8

※ Cement use
접착제를 사용하세요.

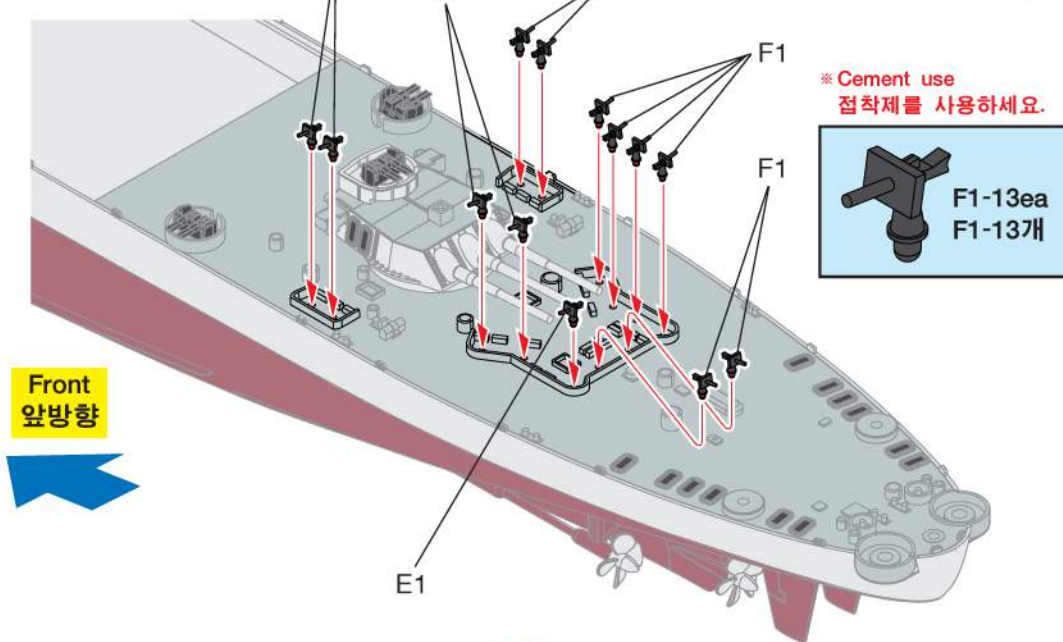
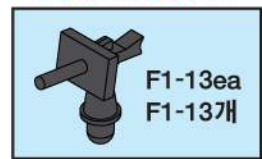

7

9

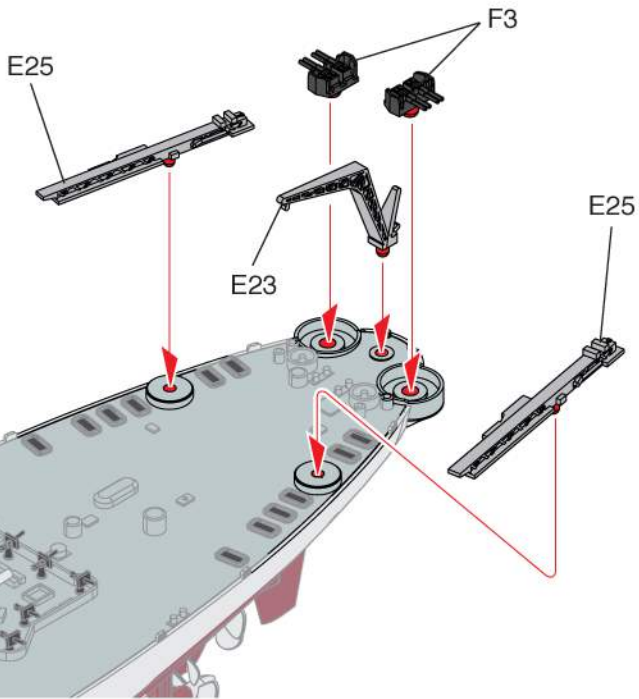

Front
앞방향



10



Curtiss-SC-1 ※ Cement use
 커티스-SC-1 접착제를 사용하세요.

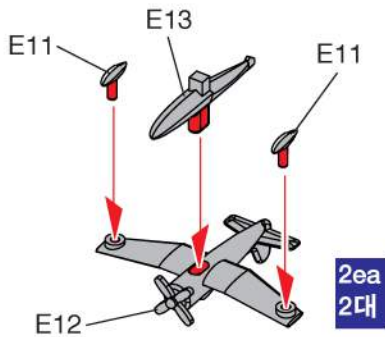

2ea
2대

Front
앞방향



※ Cement use
 접착제를 사용하세요.



MANUAL 1



MANUAL 2

※ To be continued manual second time!
 두번째 설명서로 이어집니다!

ACADEMY
 HOBBY MODEL KITS

ACADEMY
 ACADEMY PLASTIC MODEL CO., LTD.
 2014년 12월 26일 - 01 - 480-8555

Bridge part 2
함교부품 2

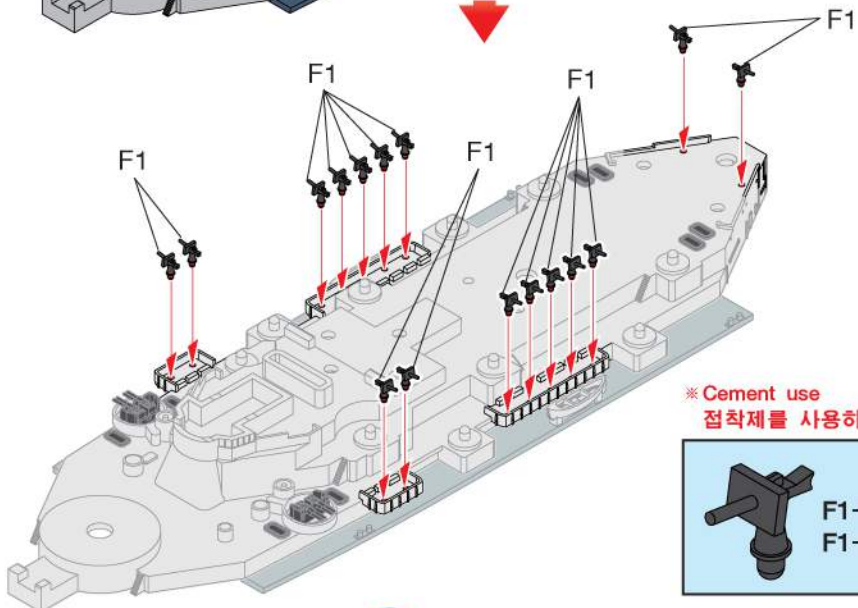
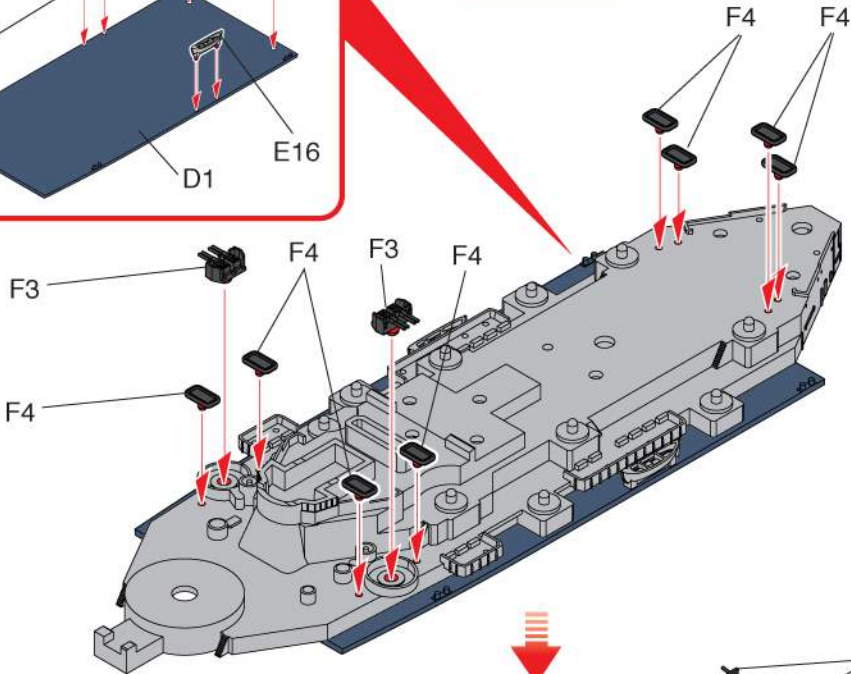
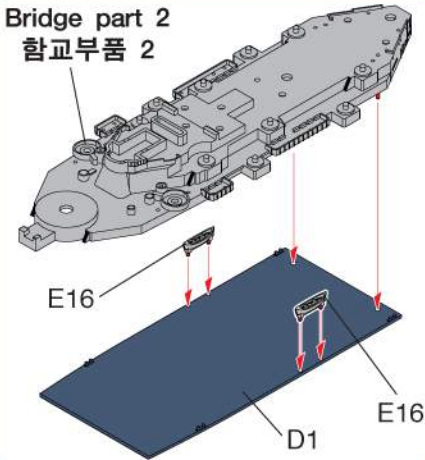

* Cement use
접착제를 사용하세요.



13

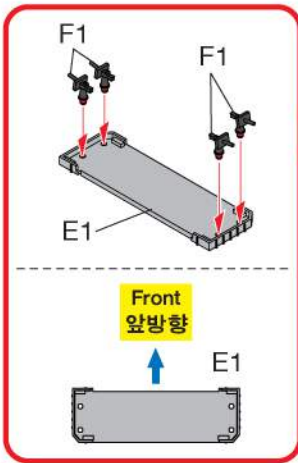

※ Cement use
 접착제를 사용하세요.

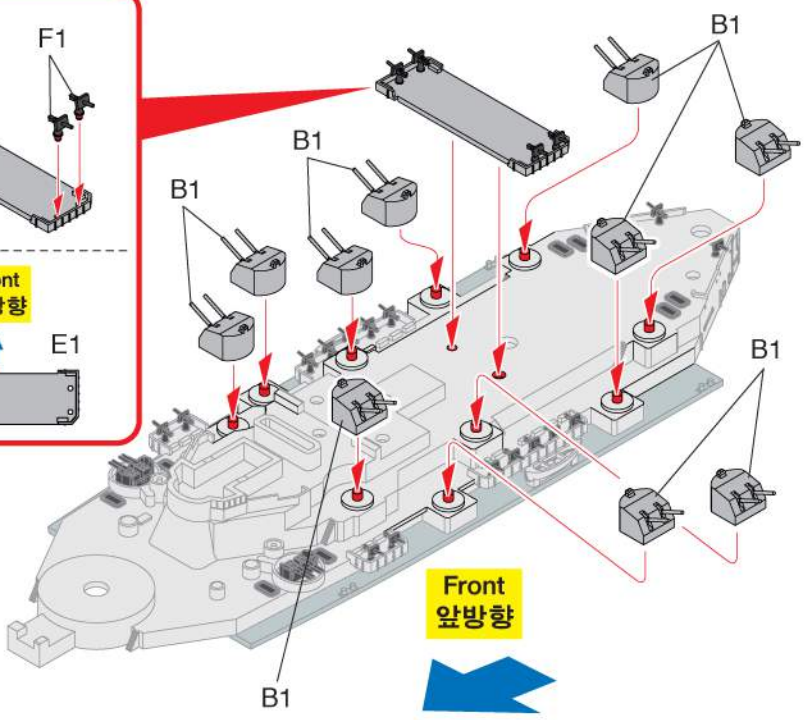

14

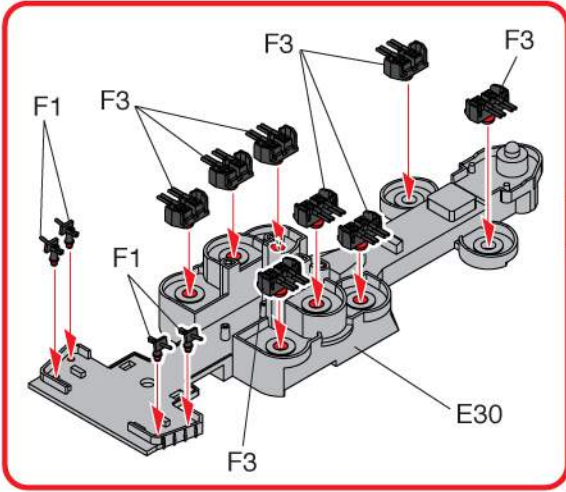

※ Cement use
 접착제를 사용하세요.

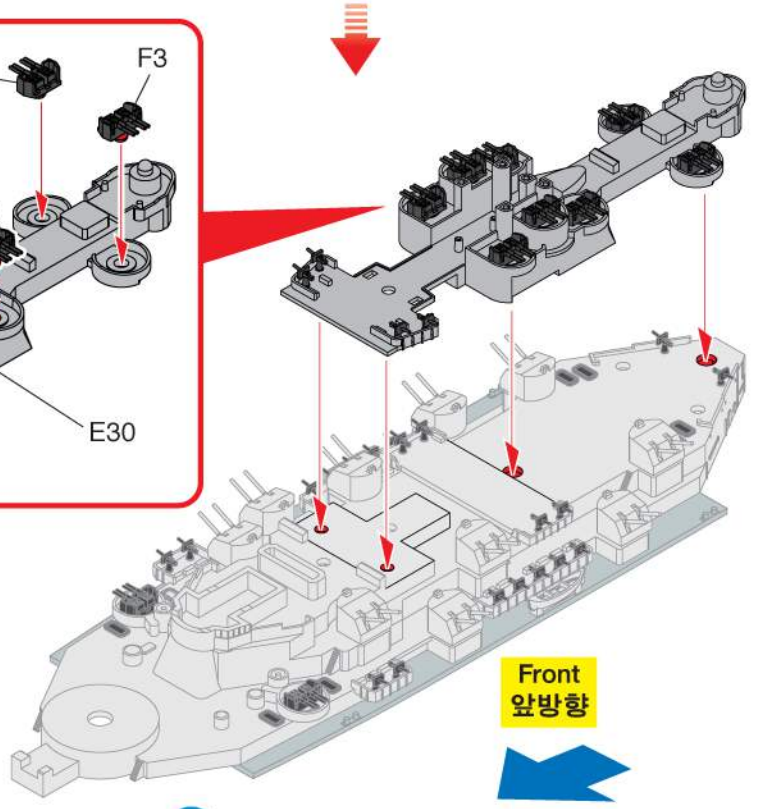

※ Start assemble with number ①
①번부터 조립 합니다.

※ Cement use
접착제를 사용하세요.

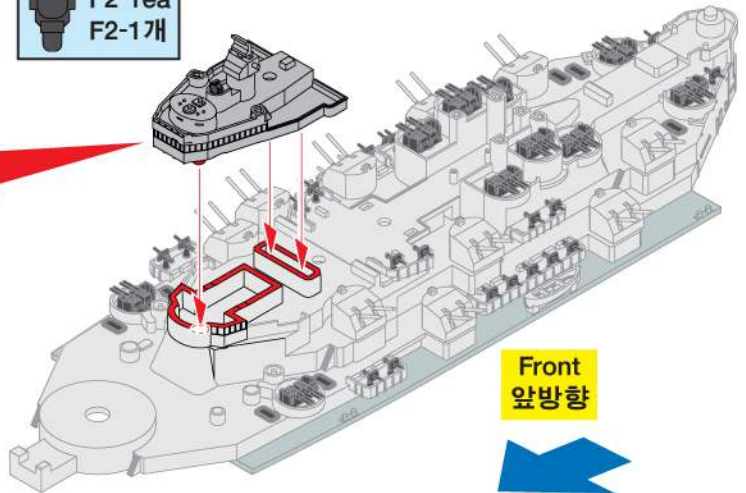
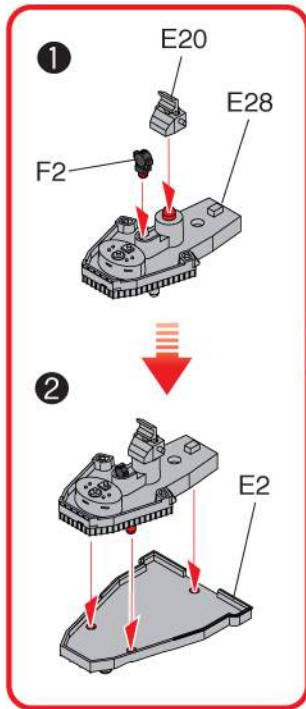

Front
앞방향

※ Start assemble with number ①
①번부터 조립 합니다.

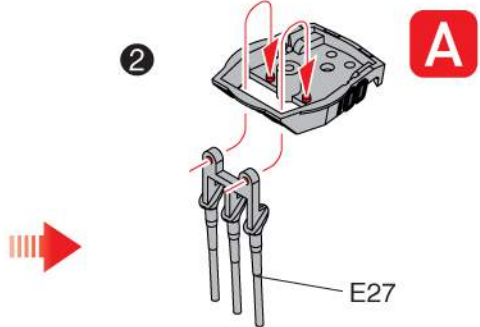
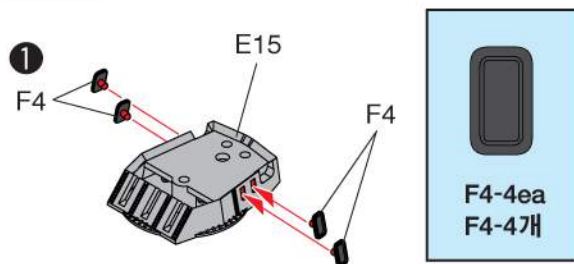

※ Cement use
접착제를 사용하세요.

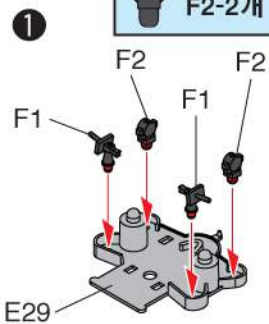

※ Cement use
접착제를 사용하세요.

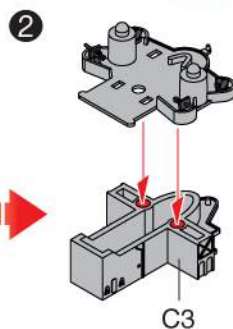
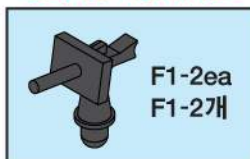

B

C

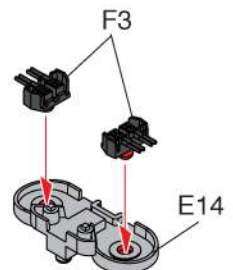

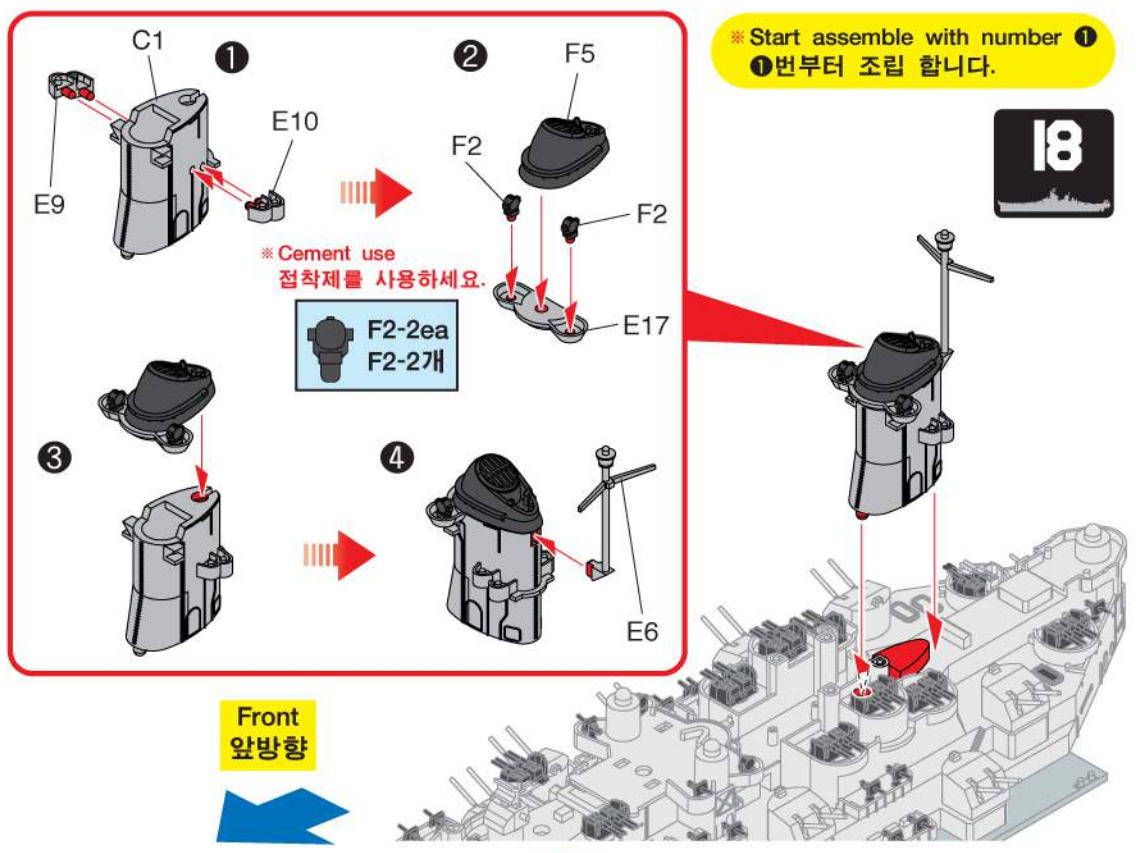
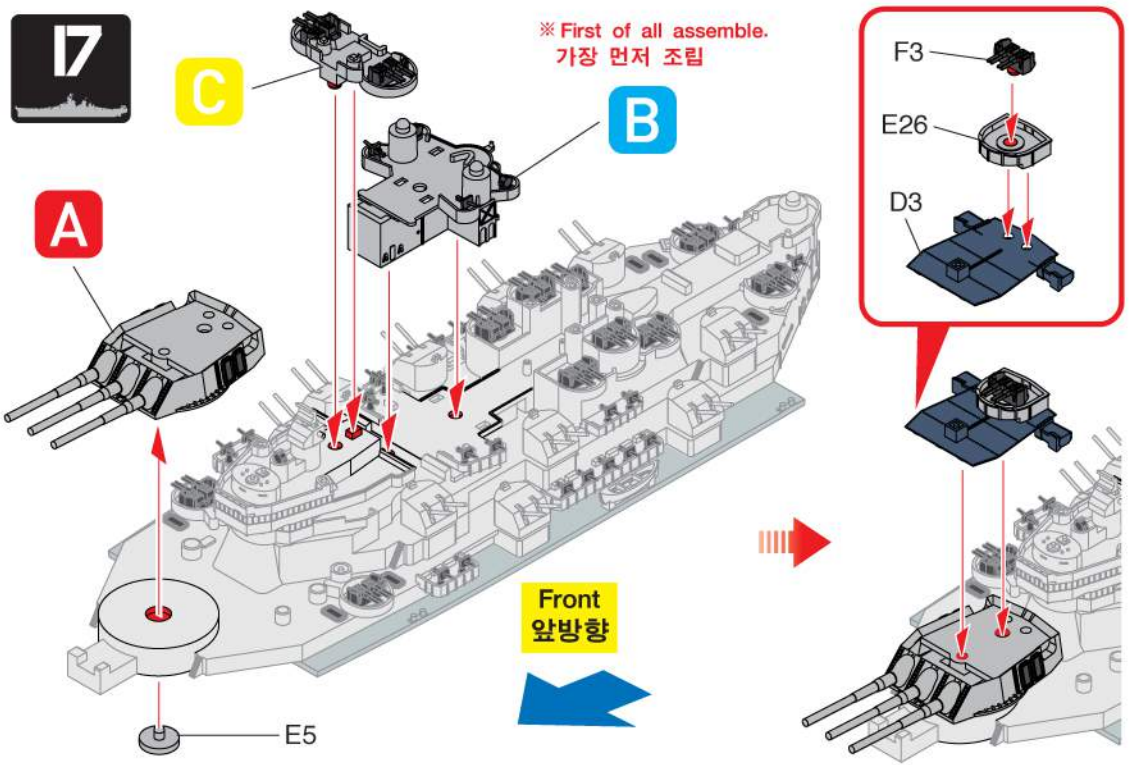

19

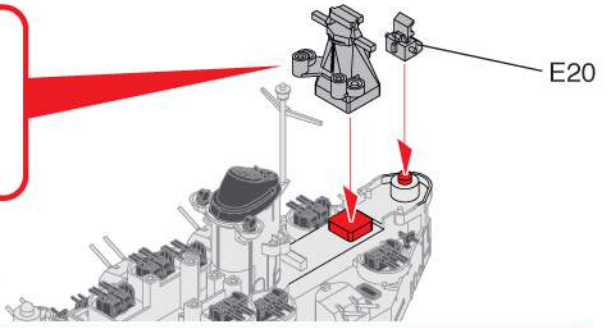
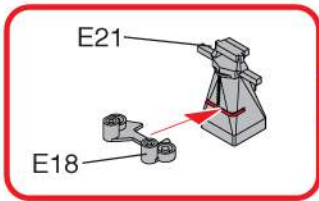

Front
앞방향

※ Start assemble with number ①

①번부터 조립 합니다.

※ Cement use
접착제를 사용하세요.

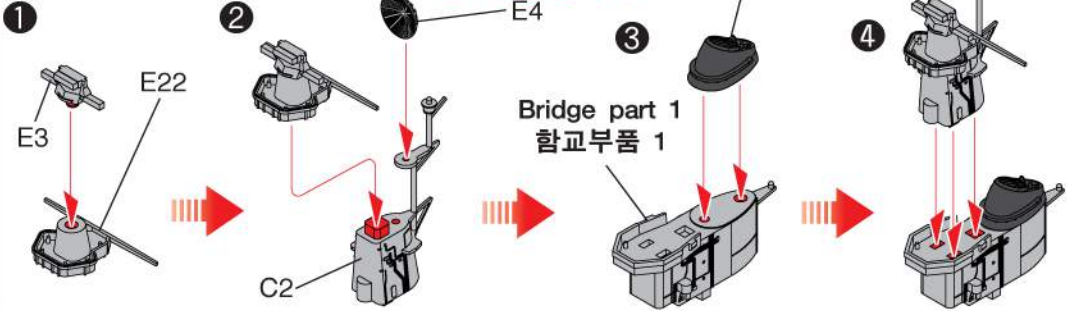

Top view
윗면

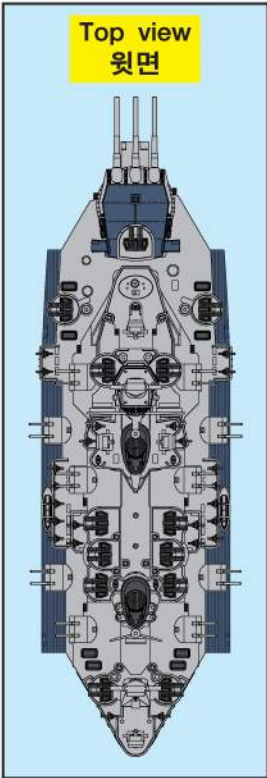

20

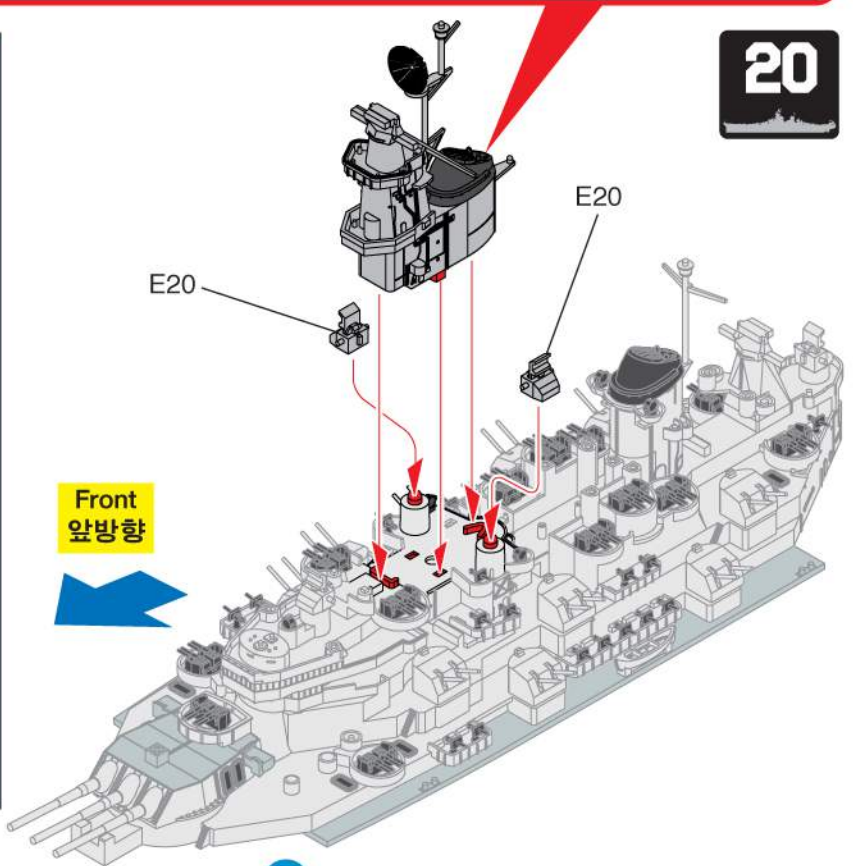

Front
앞방향

21

Front
앞방향

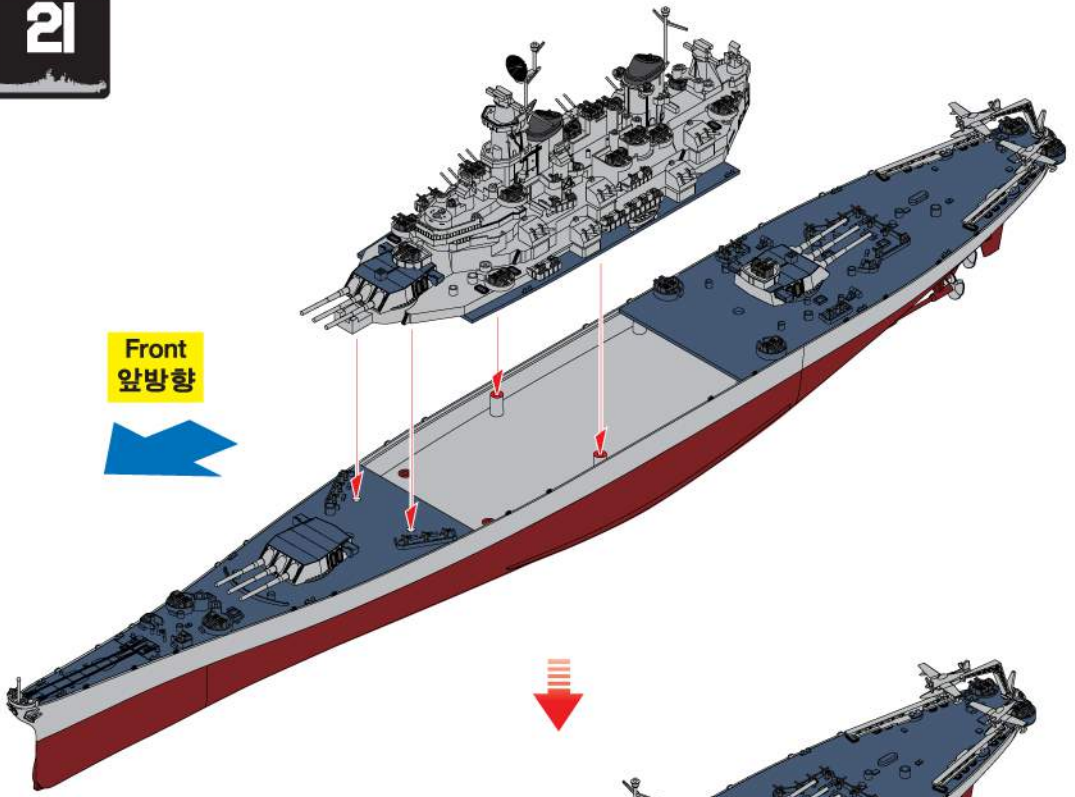

22

Front
앞방향

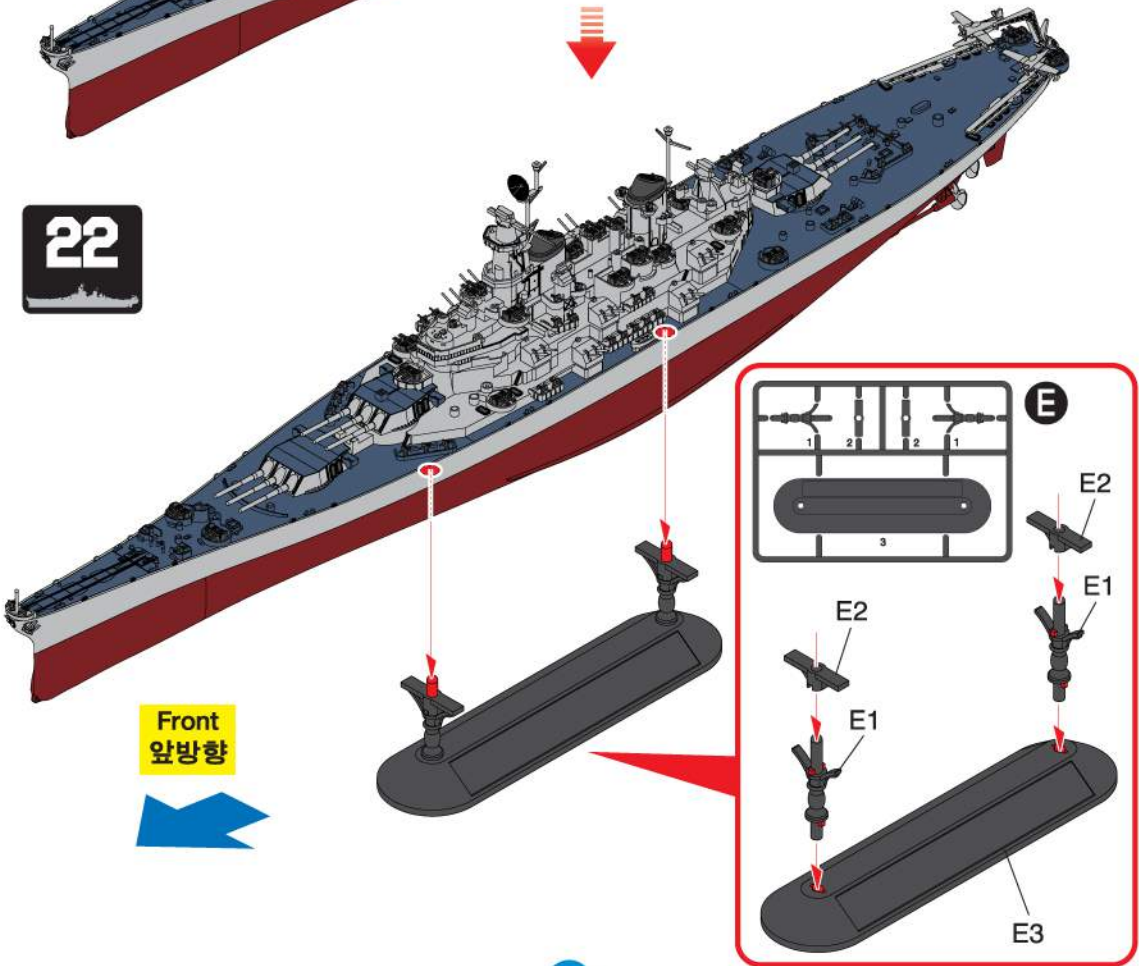

decal placement/ 전사지붙이기

MAIN COLOR	HAZE GRAY 5-1	SEA BLUE 5-5	HAZEL 5-3	DECK BLUE 20-8	RED BUSH 1-1	HULL RED	WHITE
PAINT INDEX	HAZE GRAY 5-1	SEA BLUE 5-5	HAZEL 5-3	DECK BLUE 20-8	RED BUSH 1-1	HULL RED	WHITE
HAZE GRAY 5-1	156	156	156	156	156	156	156
OCEAN GRAY 5-0	156	156	156	156	156	156	156
SEA BLUE 5-5	96	96	96	96	96	96	96
DECK BLUE 20-8	381	381	381	381	381	381	381
NAVY BLUE 53-924	144	144	144	144	144	144	144
BLUE 65-03316	177	177	177	177	177	177	177
FLAT BLACK 3-0	34	34	34	34	34	34	34
STEEL 53	53	53	53	53	53	53	53
SILVER 11	11	11	11	11	11	11	11
GOLD 16	16	16	16	16	16	16	16

*Stern
선미

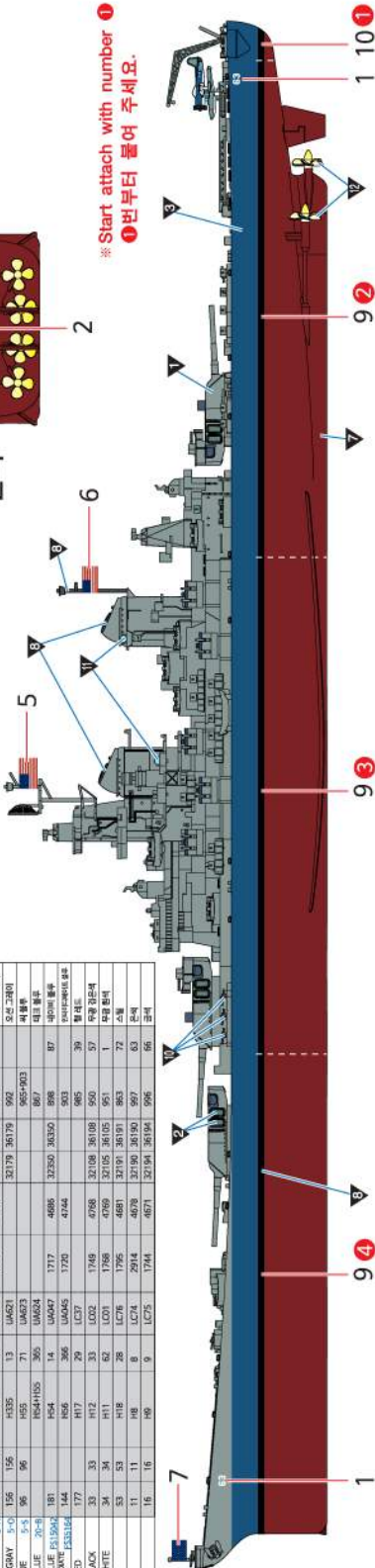
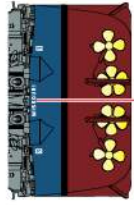

※ Start attach with number 1
①번부터 붙여 주세요.

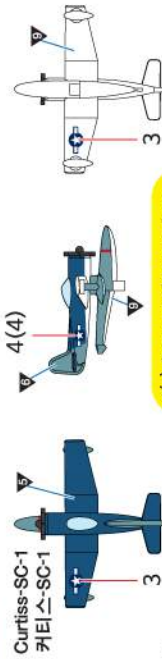
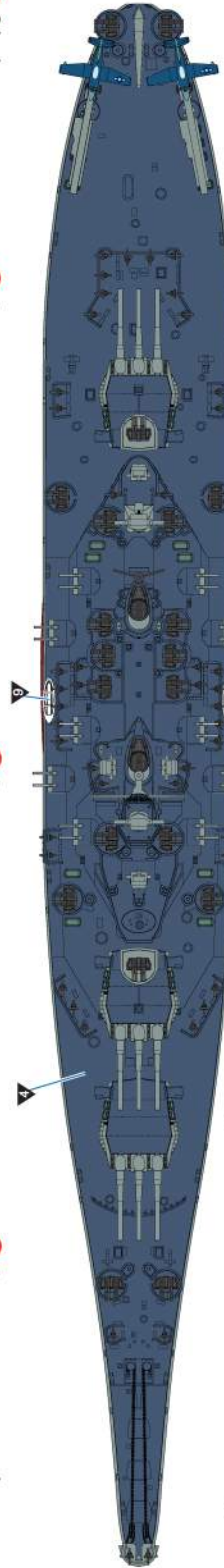

Curtiss-SC-1
커티스-SC-1

※ () is opposite number.
()는 반대측 번호입니다.

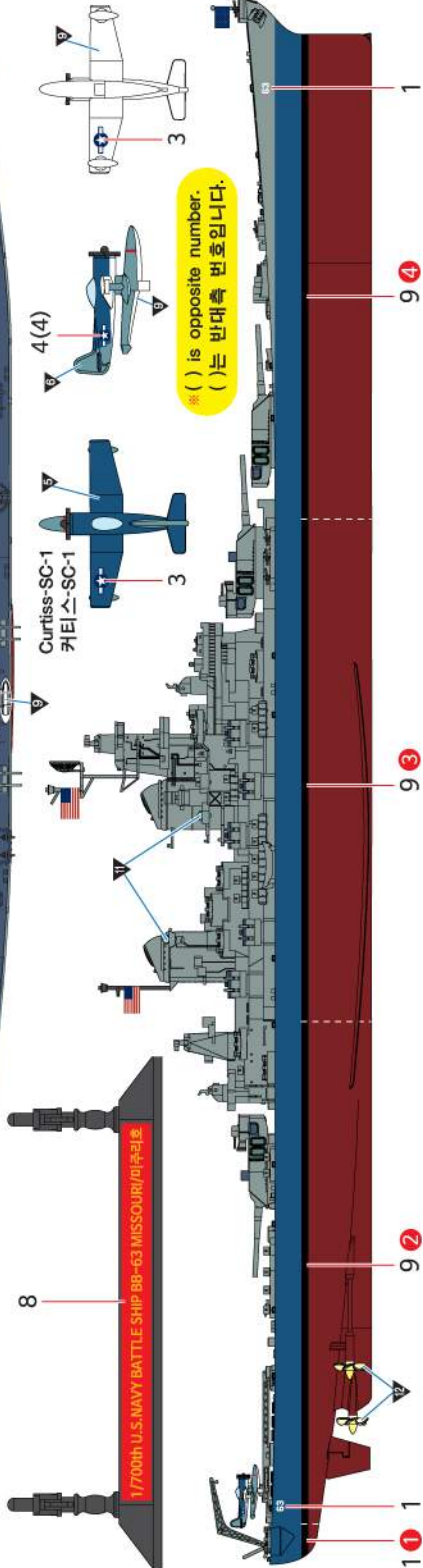

sticker placement/ 스티커 붙이기

ACADEMY
HOBBY MODEL KITS

ACADEMY
ACADEMY PLASTIC MODEL CO., LTD.
그린벨트로동: 031-800-8059

*Stern
선미

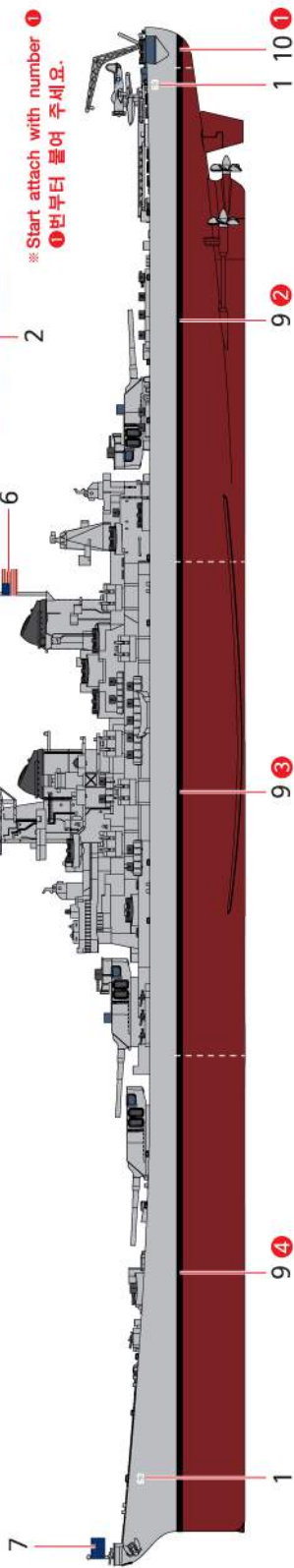

※ Start attach with number ①
①번부터 붙여 주세요.

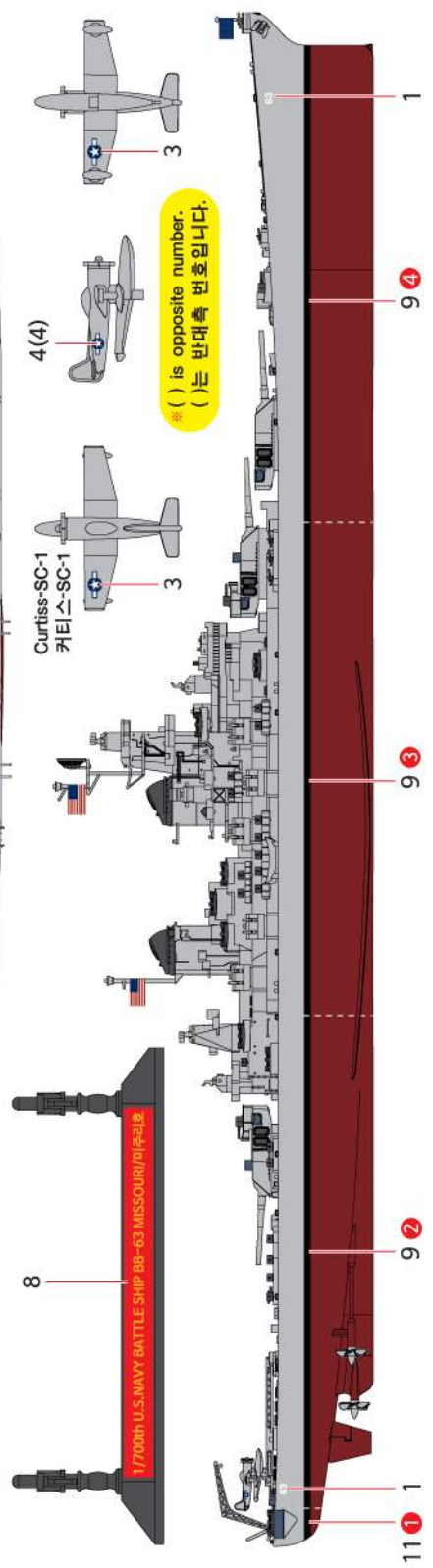
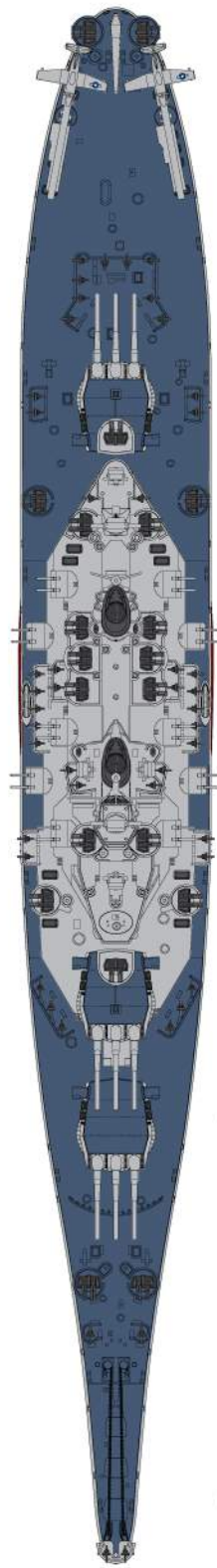

※ () is opposite number.
()는 반대쪽 번호입니다.

Curtiss-SC-1
커티스-SC-1