

SOAREASY

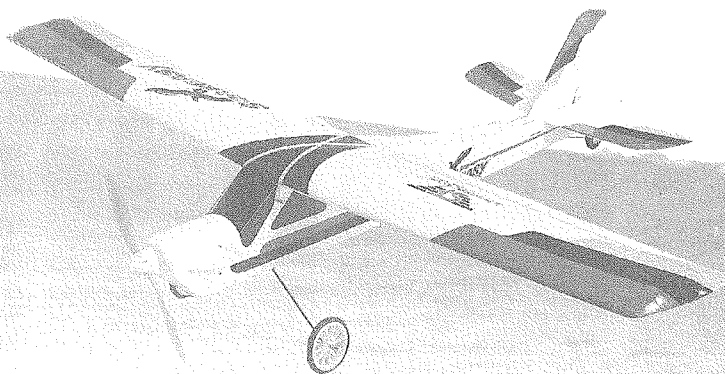
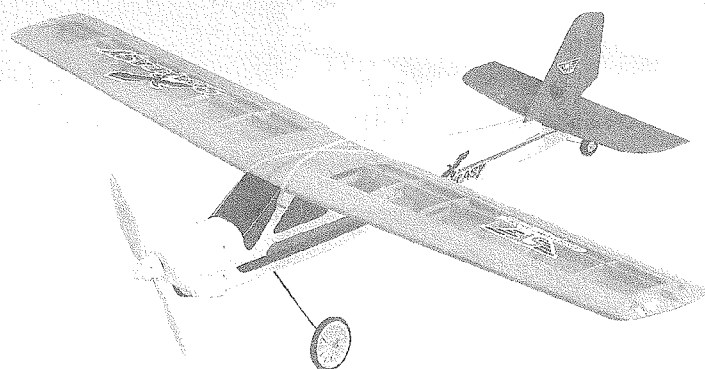

No. EP-11 組裝說明書

規格 / SPECIFICATIONS

翼展 / WING SPAN: 1080 mm (42.5 in)

翼面積 / WING AREA: 16.4 dm² (253.5 sq. in)

全長 / LENGTH: 810 mm (31.8 in)

重量 / WEIGHT: 580~700 g
(20.4~24.7 oz)

馬達 / MOTOR: # 400

遙控器 / RADIO: 4Ch

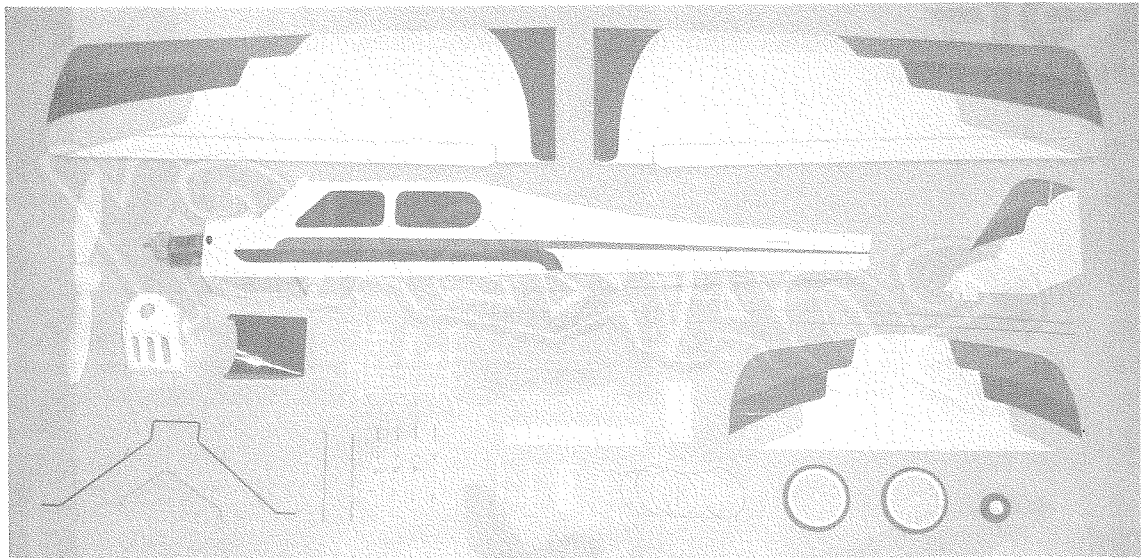

套件含以上零件 The whole accessories including in this kit.

建議使用配備 (另購)

4動 (或以上) 遙控器

迷你伺服機 x 3

迷你接收機

16A電子變速器

9.6V 600mAh~1100mAh 鎳鎘電池組

Recommended radio and electronic equipment (Not included in kit)

4 or up channel radio

Micro servos x 3

Micro receiver

16-A electric speed control

9.6V 600mAh~1100mAh Ni-cd battery pack

選購配件 Optional accessories

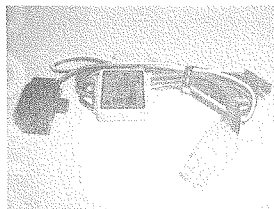

#2400
16A電子變速器
16A-Speed control

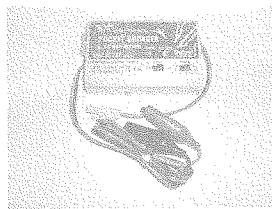

#3911
電池充電器
Pocket charger

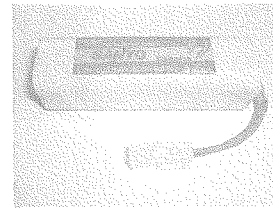

#3351
600 mAh 電池組
600 mAh Battery pack

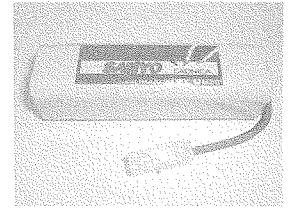

#3352
1100 mAh 電池組
1100 mAh Battery pack

準備工具 (另購)

Z字鉗 1.5 mm六角扳手

美工刀 尺

尖嘴鉗 5分鐘AB膠

十字螺絲起子 簽字筆

Tools and supplies needed(Not included in kit)

Z-Bender 1.5 mm Allen wrench

Sharp hobby knife Ruler

Neddle-nose pliers 5-minute epoxy glue

Screwdriver(+) Black felt-tipped pen or pencil



主翼組裝 MAIN WING ASSEMBLY

於主翼下蓋板切開適合伺服機大小的缺口
Try to fit the two wing halves together and locate the servo on the jointing place of the bottom main wing. Use pen to trace the servo's outline on the main wing.
Use hobby knife to cut off the tracing area.

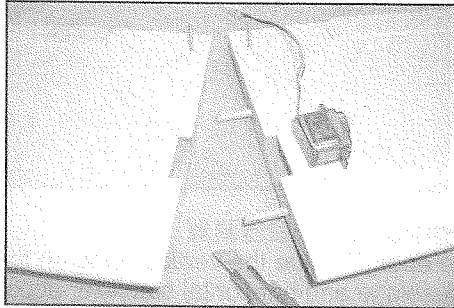

以AB膠黏合左右翼
Use epoxy to glue two wing halves together.

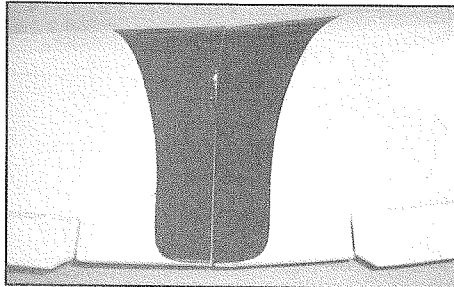

貼上主翼接縫條
Apply the wing-reinforcing sticker on the jointing place.

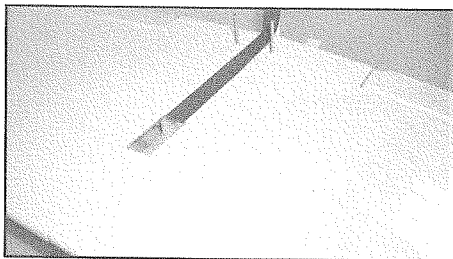

依伺服機固定木塊位置, 切除欲黏合處的包覆紙
Try to locate the servo-mounting blocks on the main wing-jointing place and cut off the extra reinforcing sticker.

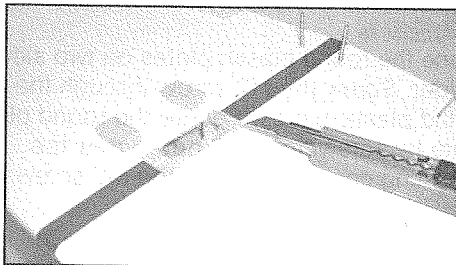

以AB膠黏合伺服機固定木塊再安裝副翼伺服機
依所需連桿長度加工, 組立調整頭. 連桿與連桿頭
Glue the servo-mounting blocks on this cutting area. Screw the servo on the servo mounting blocks. Assemble the pushrods with servo horn and aileron horn.

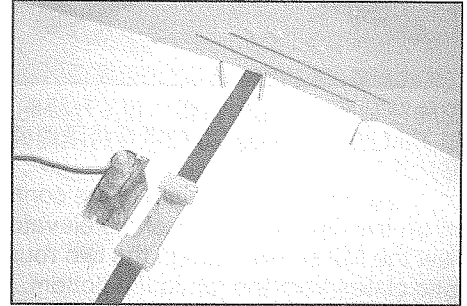

完成副翼伺服機安裝, 副翼行程設定
Adjusting the rod length by screwing in or out until the aileron is exactly in the neutral position when the servo is centered and the clevis is in the aileron horn. Adjust both sides.

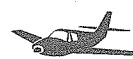
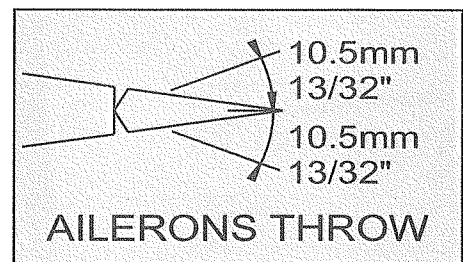
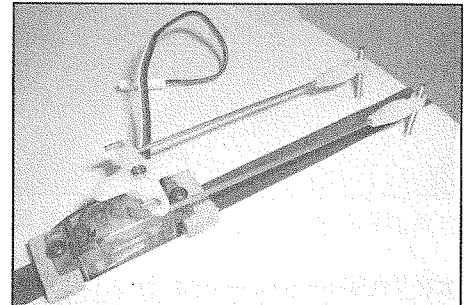

尾翼裝配 TAIL WING ASSEMBLY

以AB膠黏合水平翼, 水平翼固定時需如圖對稱及平行

Spread epoxy on the horizontal stabilizer where it contacts the fuselage.

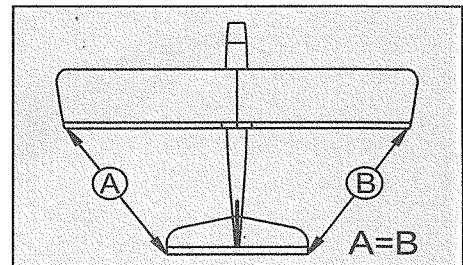

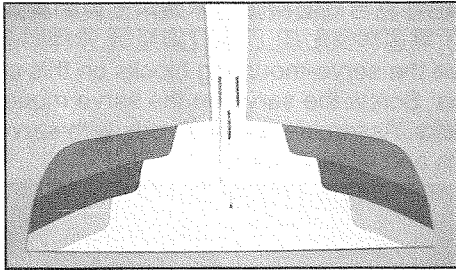

將舵角控制器的橢圓形塑膠片置於升降舵上下兩側,將M2螺絲貫穿後,以M2螺帽將兩側橢圓形塑膠片鎖緊

Locate the round plastic plate of the control horn on the top and bottom of the elevator. Screw the M2 screw through the two round plastic plates from the top to the bottom. Secure the round plastic plate by screwing in M2 nut.

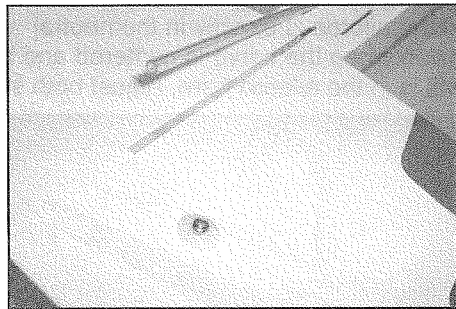

把舵角調整頭旋入螺絲,完成升降舵的舵角控制器

Screw the adjusting control horn into the screw.

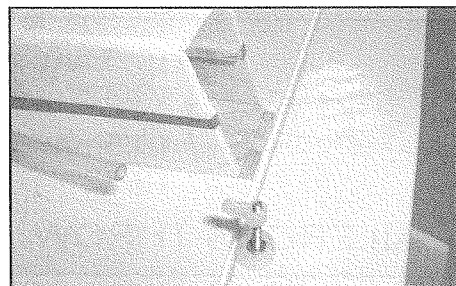

如圖將尾輪架穿過尾輪架座,將尾輪架上端以鉗子彎曲成90度

Insert the tail gear into the tail gear mount. Use pliers to bend one end of the tail gear into 90 degree for assembling with tail wheel.

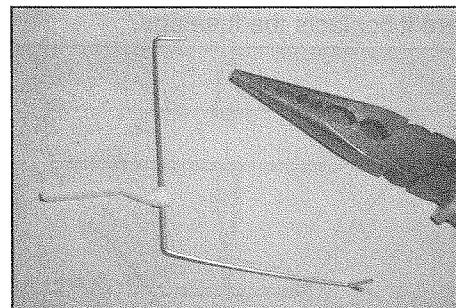

將尾輪架上端穿過水平翼的小孔,再以2x10木螺絲將尾輪架座固定於機尾底部

Insert the other end of the tail gear into the hole on the elevator and secure it on the tail wing by 2x10 tapping screw.

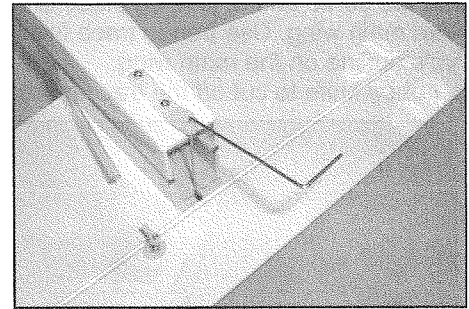

如圖示以AB膠黏合垂直翼

Use epoxy to glue the vertical wing on the tail of fuselage and horizontal stabilizer according to the instruction on drawing #18.

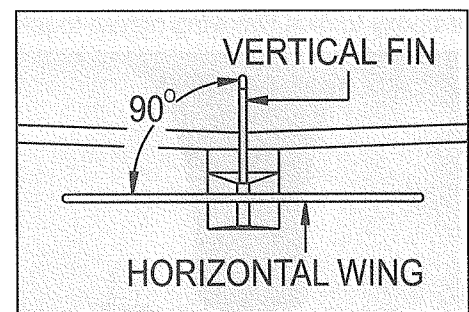

尾輪架上端置入垂直翼的L型缺口

Insert the top end of the tail gear into the L slot on the vertical wing.

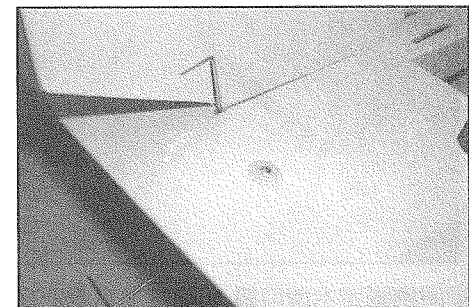

將舵角控制器的橢圓形塑膠片置於方向舵兩側,將M2螺絲貫穿後,以M2螺帽將兩側橢圓形塑膠片鎖緊,把舵角調整頭旋入螺絲,完成方向舵的舵角控制器

Place the round plastic plates on two sides of rudder. Screw the M2 screw through the two round plastic plates. Secure the round plastic plate by screwing in M2 nut. Screw the adjusting control horn into the M2 screw.

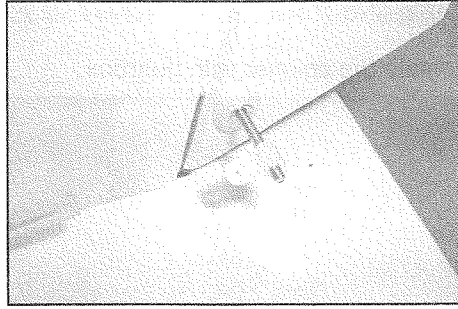

機身組裝 FUSELAGE ASSEMBLY

依伺服機大小,將木條黏合於機身內側,將連桿套管分別穿過固定片2孔,安裝升降舵與方向舵伺服機,依所需連桿長度於無螺紋端加工Z字,再將連桿分別穿過套管

Try to fit the servos with servo-mounting blocks inside the fuselage. When satisfy with the location, use pen to mark the location for gluing the servo-mounting blocks. Spread epoxy on two ends of servo-mounting blocks and glue them on the location that just marked. Insert the 2 pieces of tubes into the two drilled-holes on the planking. Assemble the servos for elevator and rudder. Using Z-bend pliers, make a Z-bend on the unthreaded end of each rod. Insert the rod through tube. Connect the Z bend ends with the servos.

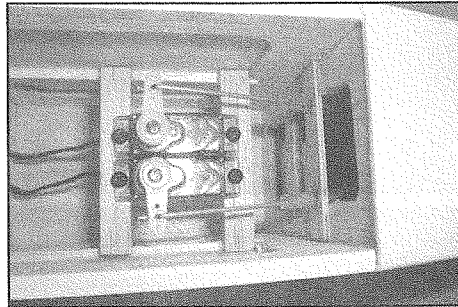
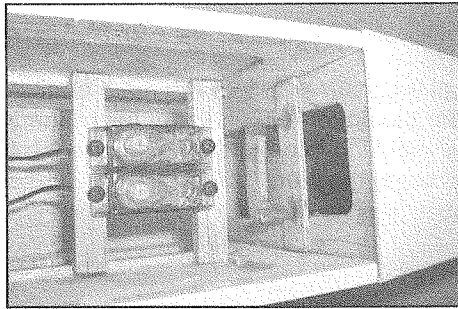

連桿頭分別旋入升降舵與方向舵的連桿並連結至升降舵與方向舵之舵角控制器

Thread the clevises into the rods and connect with control horns for elevator and rudder.

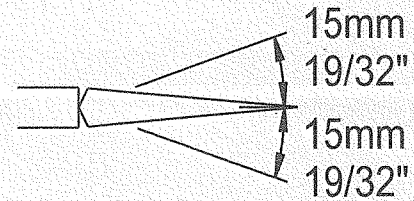
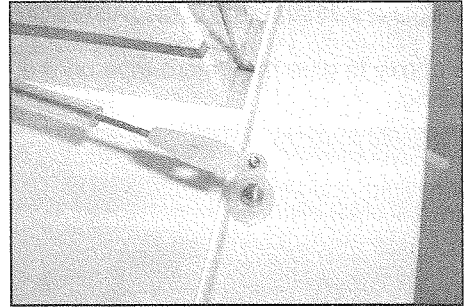

ELEVATOR THROW

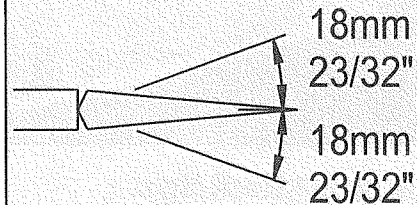
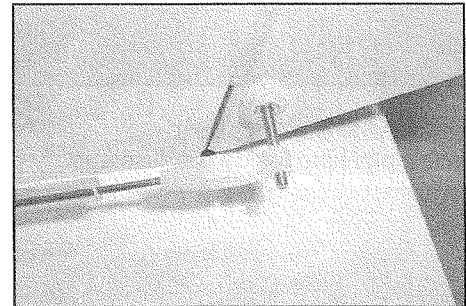

RUDDER THROW

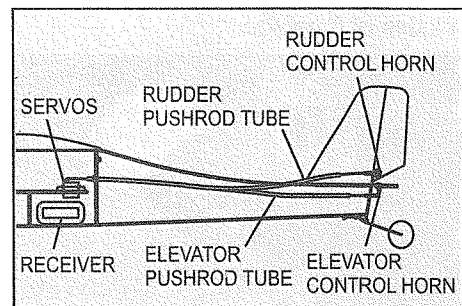

配合電池型式將固定用魔術帶以AB膠黏於木板上
 Use epoxy to glue the Velcro-tape on the planking.

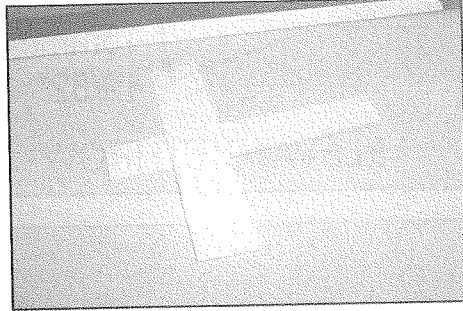

將木板以AB膠黏合於機身內
 Glue the planking inside the fuselage.

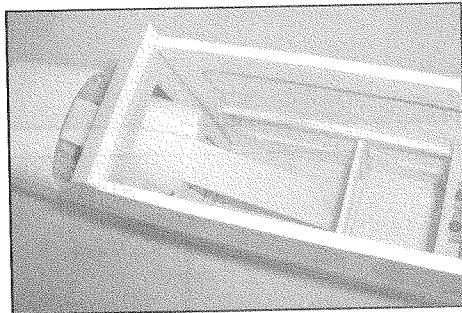

裝上前蓋,以2x6木螺絲將兩側固定
 Assemble motor with speed controller.
 Try to assemble the cowl on the front of the fuselage. When satisfy with the location, use 2x6 tapping screws to secure the cowl on both sides of fuselage.

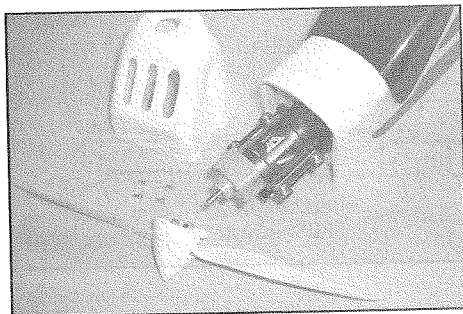

裝上螺旋槳機頭罩組,將內六角螺絲對準主軸小平面
 Assemble the spinner with gearbox.

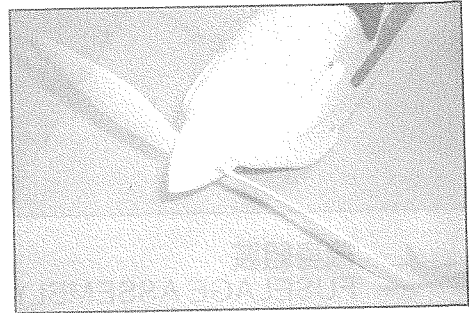

主輪架兩側輪胎以M3小螺絲搭配2mm孔之塑膠輪檔固定
 Assemble the main gear with wheels and secure the wheels with M3 screws and 2mm plastic collars.

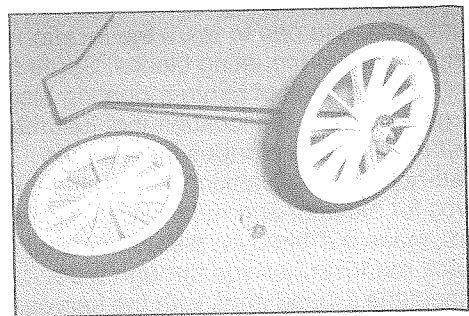

將主輪架置入輪架座凹槽,插入2mm木片,完成主輪架
 Install the main gear into the main-gear slot on the bottom of the fuselage. Insert the 2mm small planking into the slot to secure the main gear inside the slot.

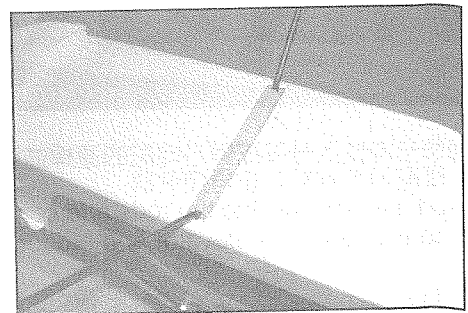
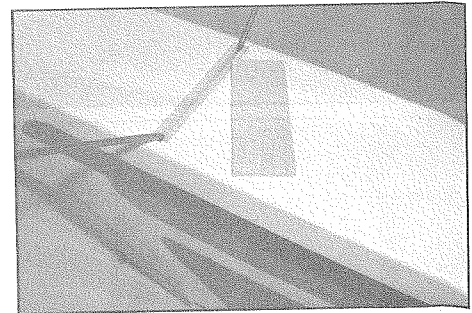

尾輪以M3小螺絲搭配1.5mm孔之塑膠輪檔固定
 Assemble the tail gear with tail wheel. Secure the tail wheel with M3 screw and 1.5mm plastic collar.

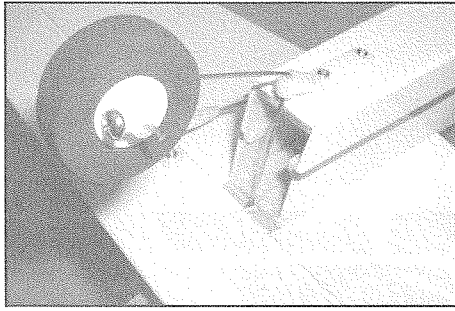

將4mm圓木棒分別貫穿前後兩側小孔,上膠完成主翼固定桿
 Take the 4 mm dowel out of the hardware bag. Insert the dowel through the drilled holes on two sides of fuselage. Spread epoxy on the dowel and secure it on the fuselage.

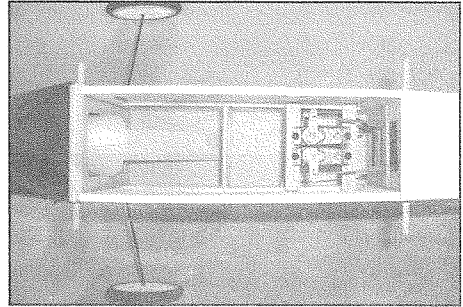

調整電池前後位置以取得正確的重心點
 Adjusting the battery for getting the correct C.G. point.

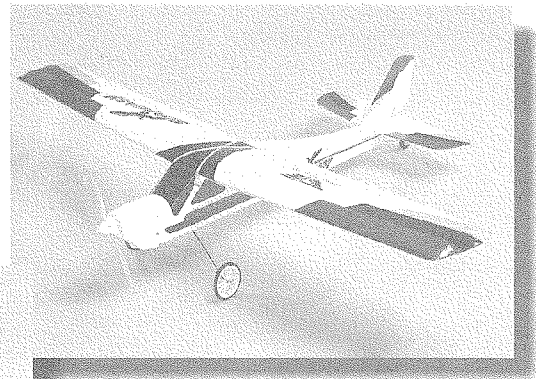
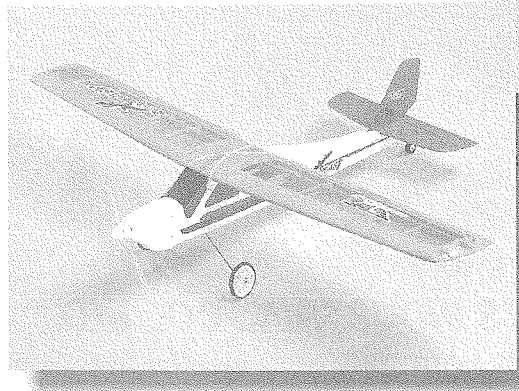
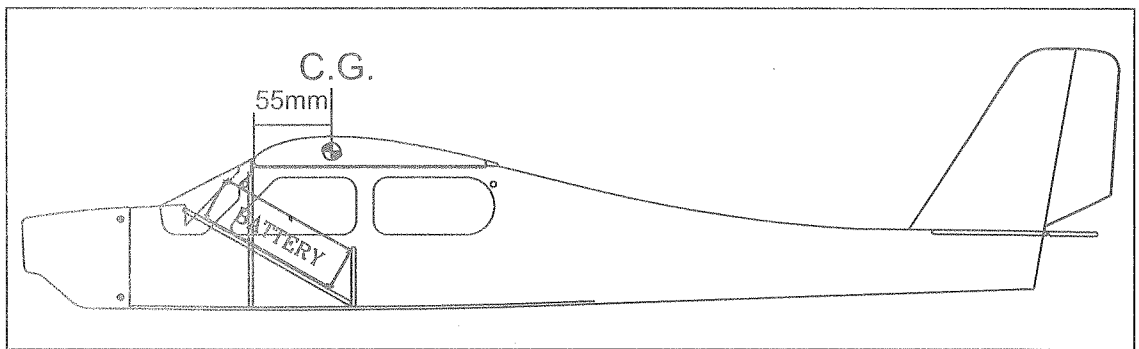

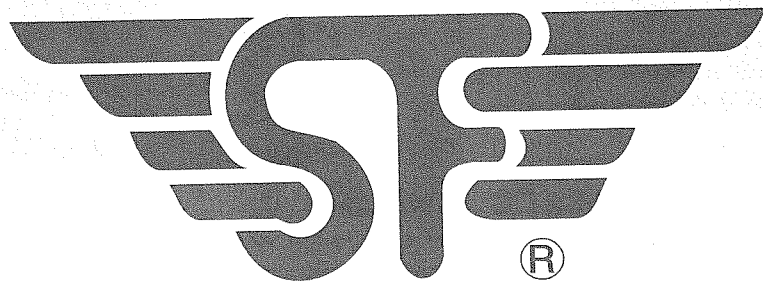

SUPER FLYING MODEL

MTH HOBBY PRODUCTS INDUSTRIAL CO., LTD.

www.mth.com.tw

© MTH HOBBY 2004